

privacy screen series

# linear panel

(page: 1 of 5)

black 

corten steel 

\*all corten steel products arrive in their raw steel (unrusted) state as shown in contents page.

### materials

panel is made from durable 16 gauge steel

### features

- modular
- all weather resistant
- optional accessories
- 85% privacy rating
- easy installation
- various configurations

### linear panel

45" L x 1.25" W x 24" H  
Weight: 17 lbs

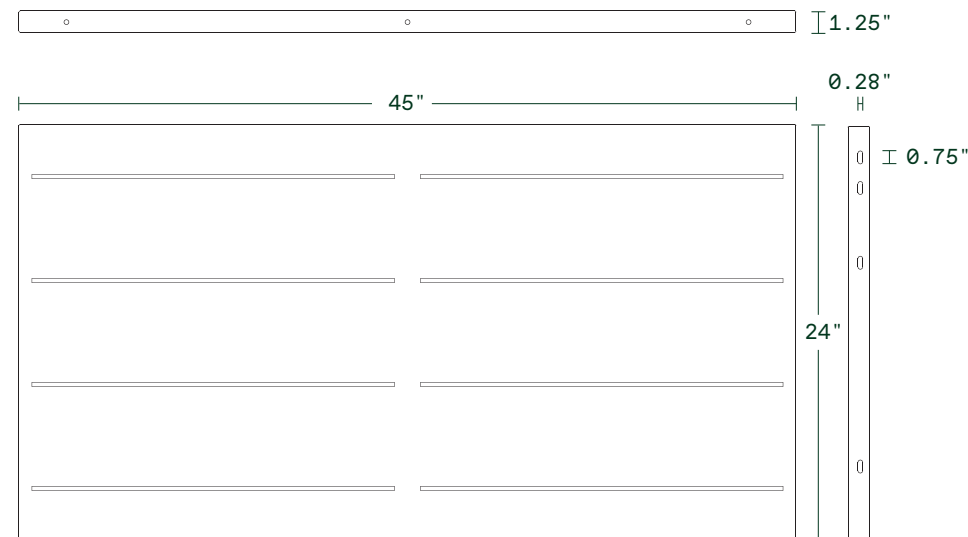
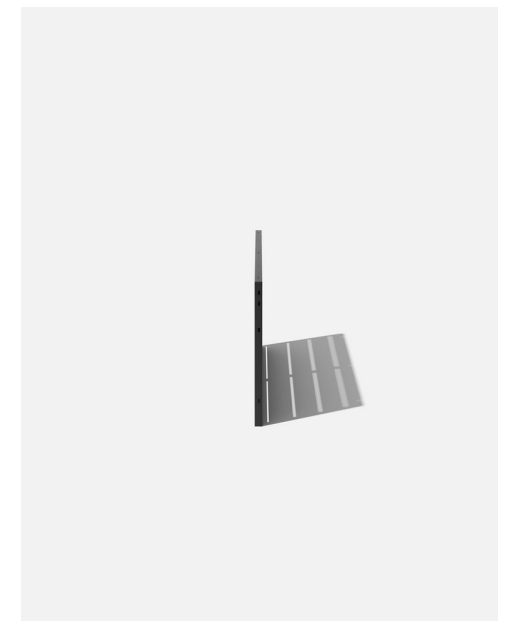
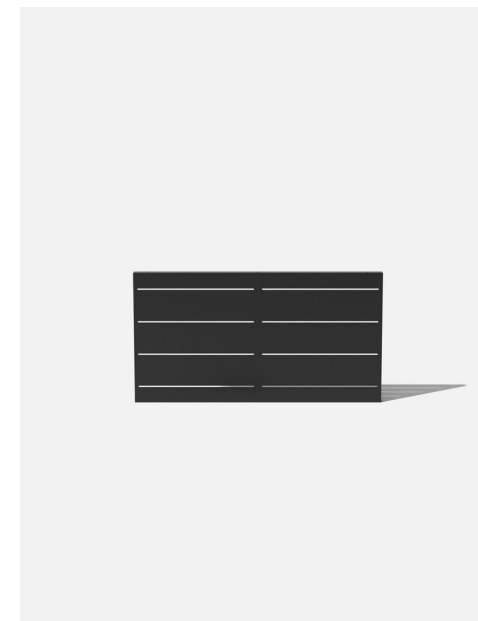
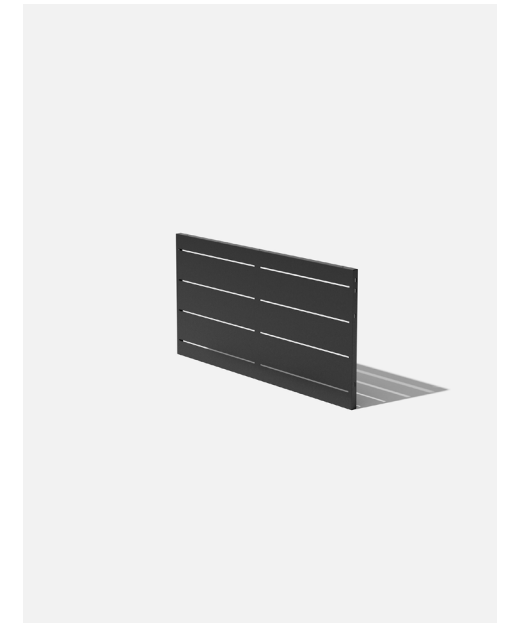

Dimensions

privacy screen series

# linear 2 panel set

(page: 2 of 5)

**black** 

**corten steel** 

\*all corten steel products arrive in their raw steel (unrusted) state as shown in contents page.

### materials

panel is made from durable 16 gauge steel  
frame is made from durable 14 gauge steel

### features

modular	95% privacy rating
all weather resistant	easy assembly
optional accessories	various configurations

### notes

Though our Privacy Screens stand tall & sturdy on their own out of the box, we recommend anchoring them to the ground for added security and safety.

### linear 2 panel set

45" L x 19.75" W x 52" H  
Weight: 43 lbs

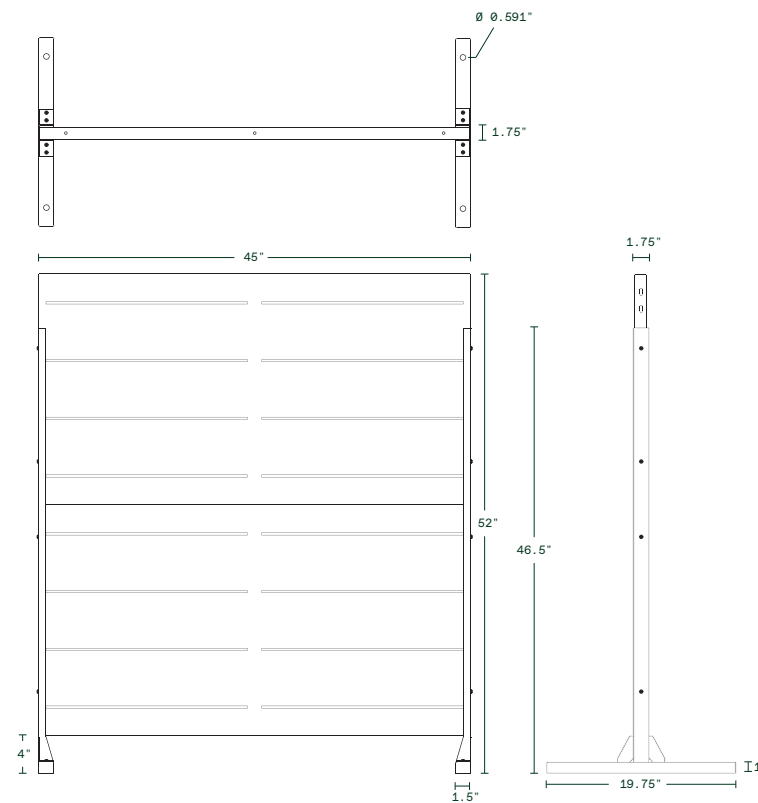

Dimensions



Button Head Hex Drive Screw  
M6x1mm Thread, 20mm Long



Hex Nut  
M6x1mm Thread

### Hardware Included

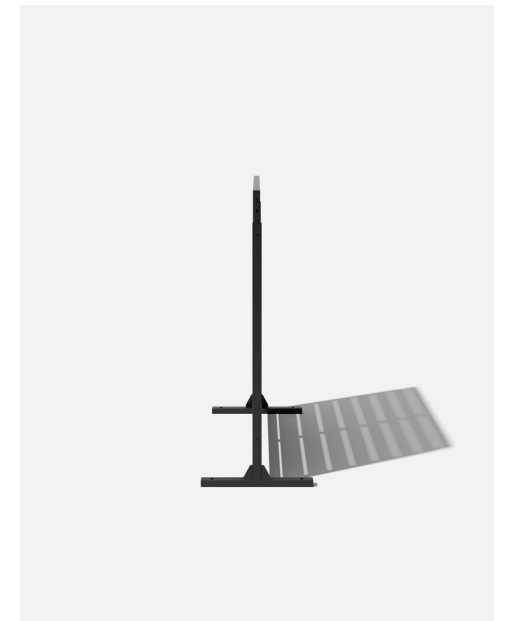
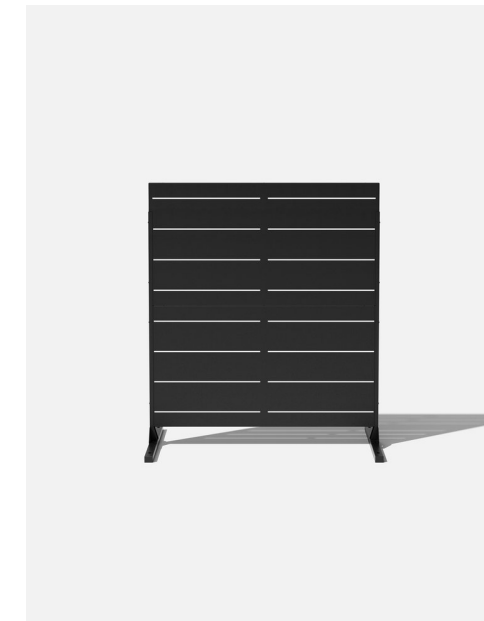
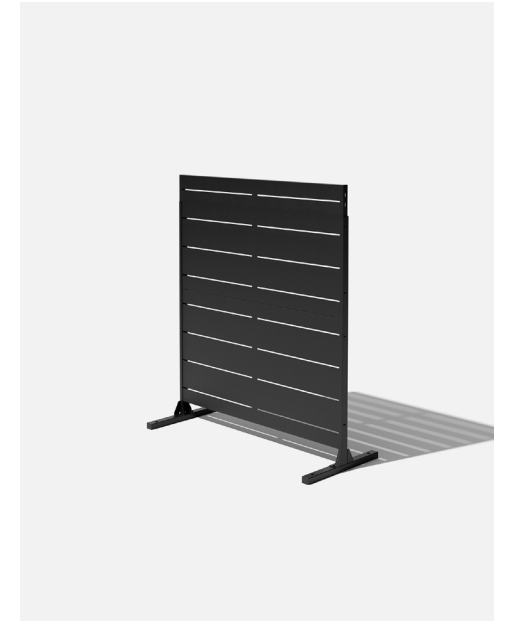

## privacy screen series

# linear 3 panel set

(page: 3 of 5)

black



corten steel



\*all corten steel products arrive in their raw steel (unrusted) state as shown in contents page.

### materials

panel is made from durable 16 gauge steel  
frame is made from durable 14 gauge steel

### features

modular	95% privacy rating
all weather resistant	easy assembly
optional accessories	various configurations

### notes

Though our Privacy Screens stand tall & sturdy on their own out of the box, we recommend anchoring them to the ground for added security and safety.

### linear 3 panel set

45" L x 19.75" W x 76" H

Weight: 63 lbs

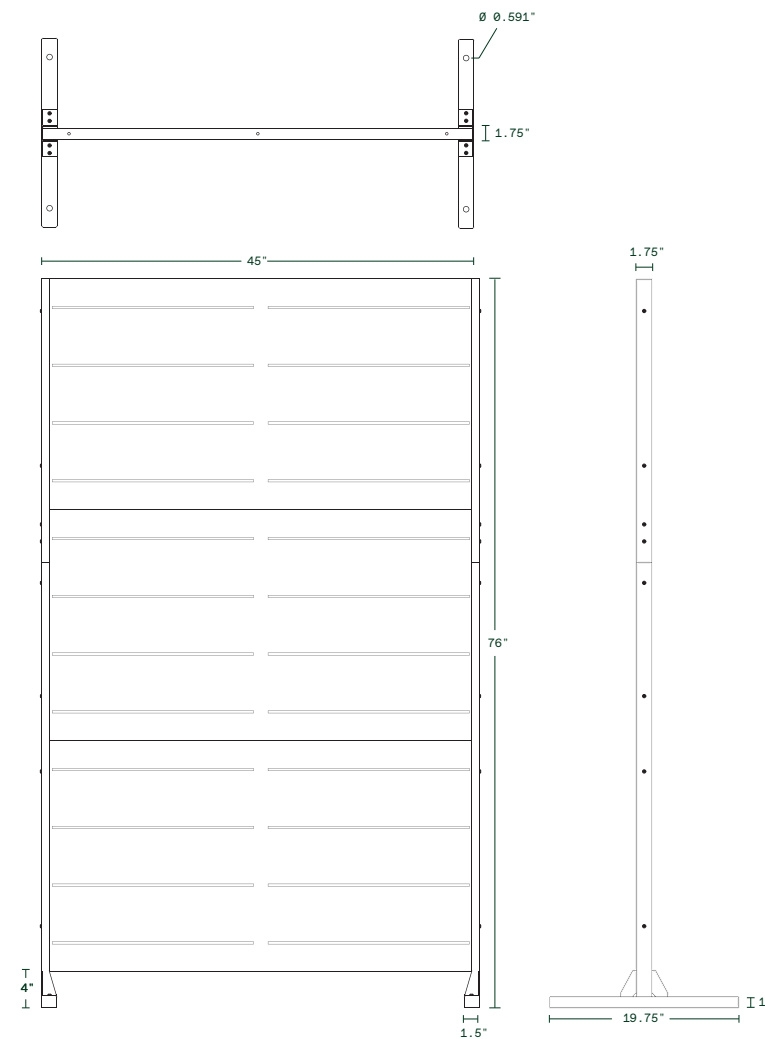

Dimensions



Button Head Hex Drive Screw  
M6x1mm Thread, 20mm Long



Hex Nut  
M6x1mm Thread

### Hardware Included

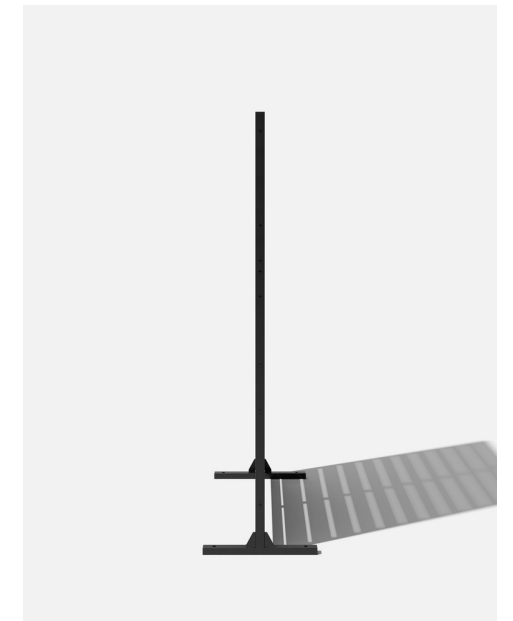
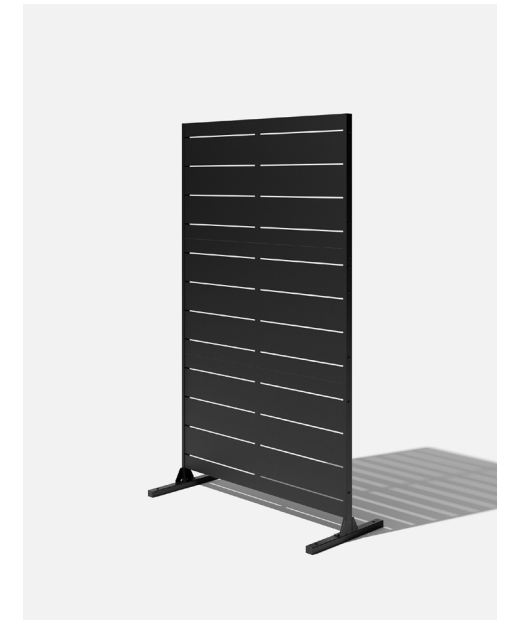
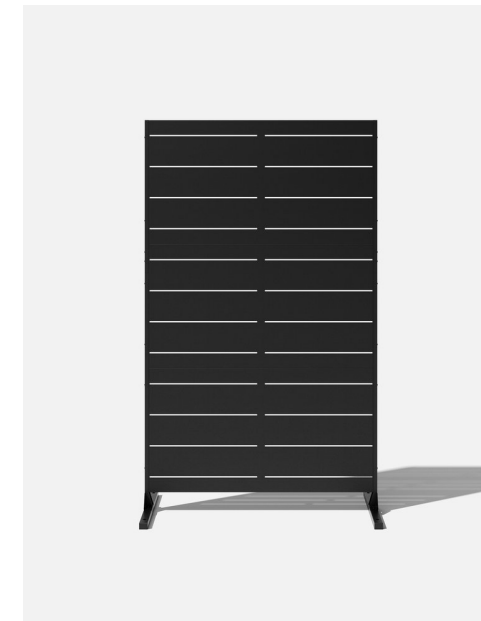

## privacy screen series

# linear 4 panel set

(page: 4 of 5)

black



corten steel



\*all corten steel products arrive in their raw steel (unrusted) state as shown in contents page.

### materials

panel is made from durable 16 gauge steel  
frame is made from durable 14 gauge steel

### features

modular	95% privacy rating
all weather resistant	easy assembly
optional accessories	various configurations

### notes

Though our Privacy Screens stand tall & sturdy on their own out of the box, we recommend anchoring them to the ground for added security and safety.

### linear 4 panel set

45" L x 19.75" W x 100" H

Weight: 83 lbs

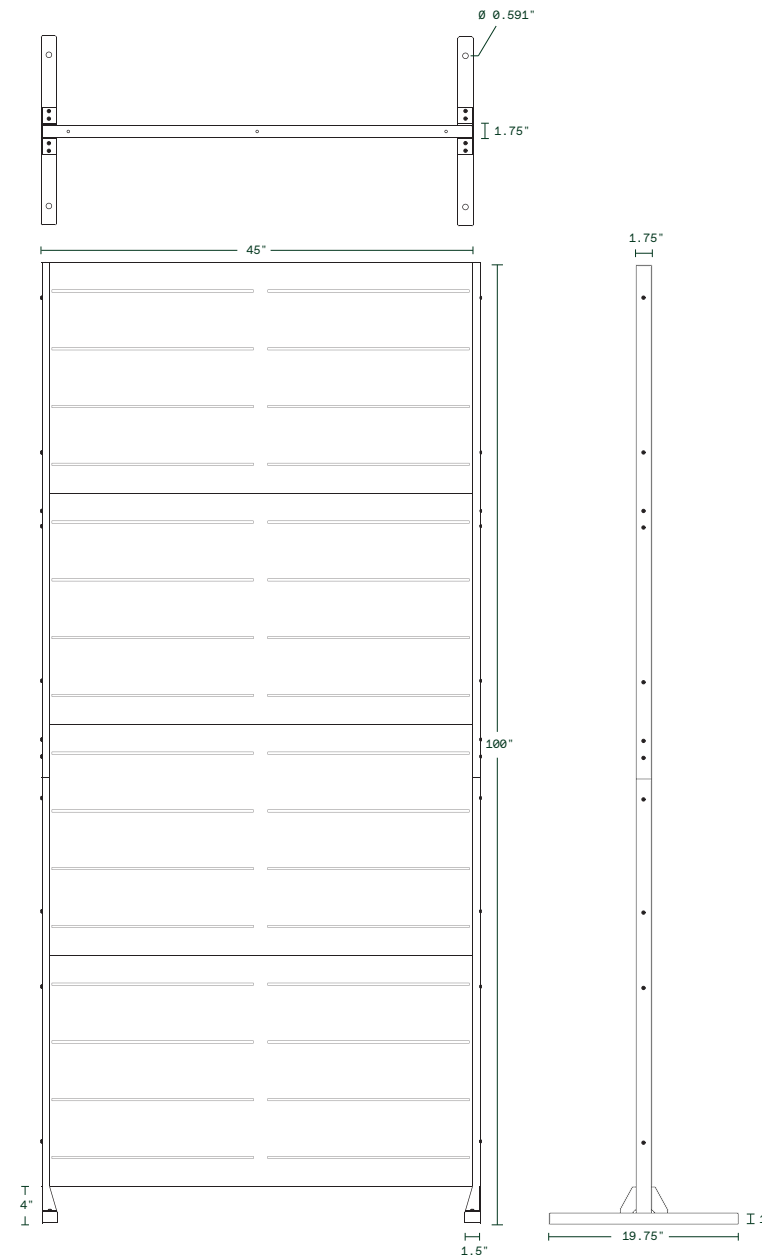

Dimensions



Button Head Hex Drive Screw  
M6x1mm Thread, 20mm Long



Hex Nut  
M6x1mm Thread

### Hardware Included

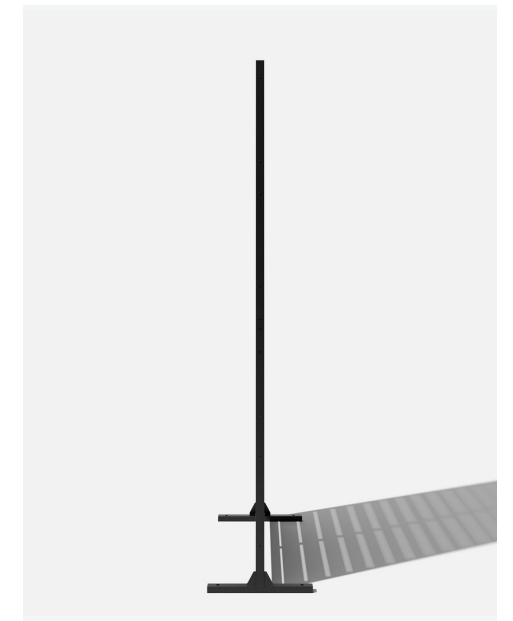
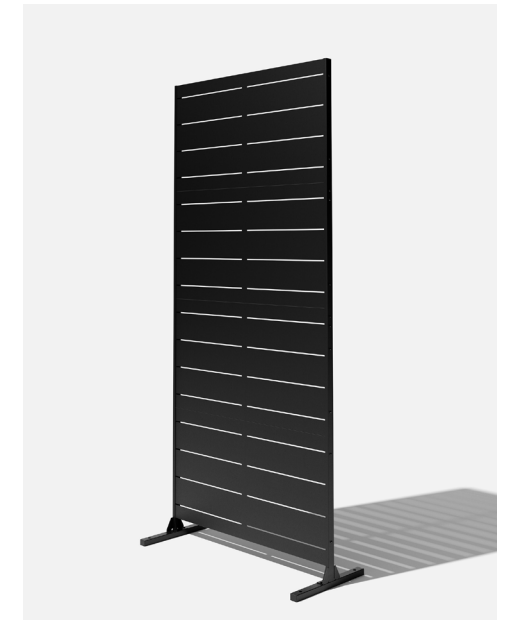
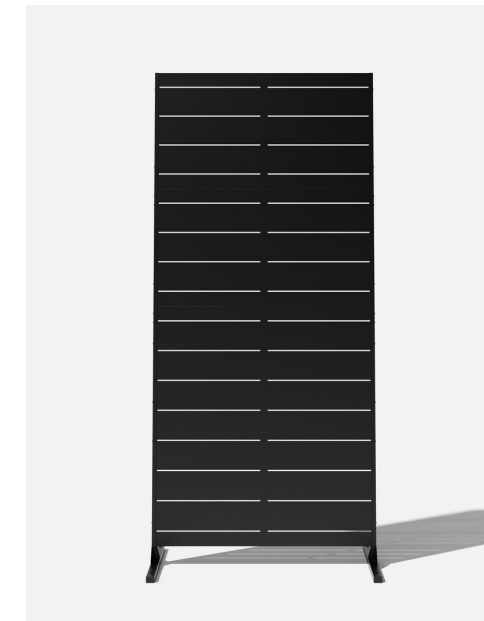

## privacy screen series

# linear corner set

(page: 5 of 5)

black



corten steel



\*all corten steel products arrive in their raw steel (unrusted) state as shown in contents page.

### materials

panel is made from durable 16 gauge steel  
frame is made from durable 14 gauge steel

### features

modular	95% privacy rating
all weather resistant	easy assembly
optional accessories	various configurations

### notes

Though our Privacy Screens stand tall & sturdy on their own out of the box, we recommend anchoring them to the ground for added security and safety.

### linear corner panel set

55.75" L x 55.75" W x 76" H

Weight: 122 lbs

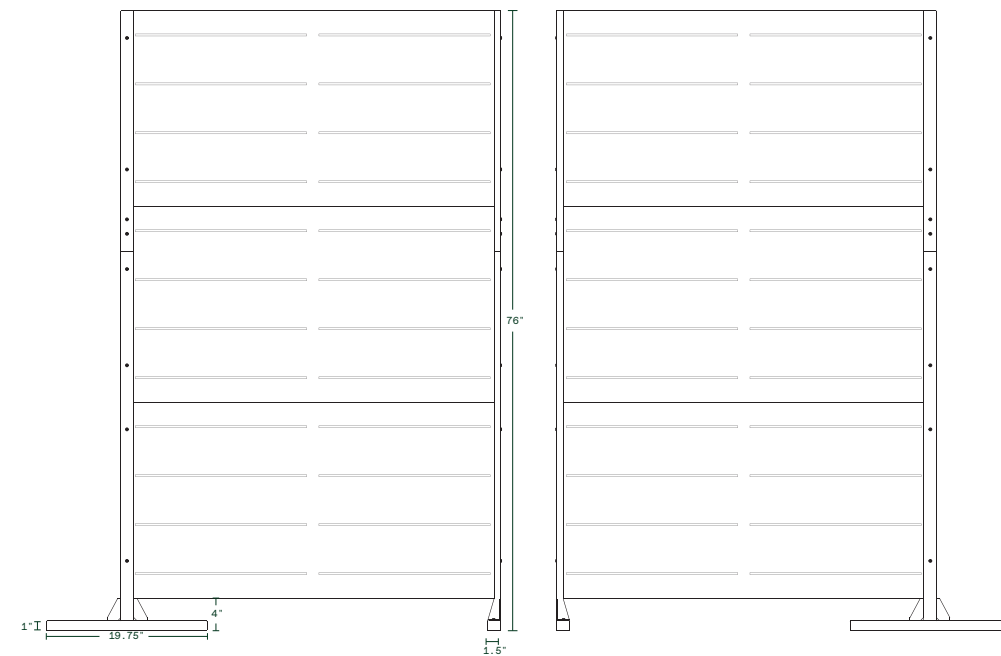
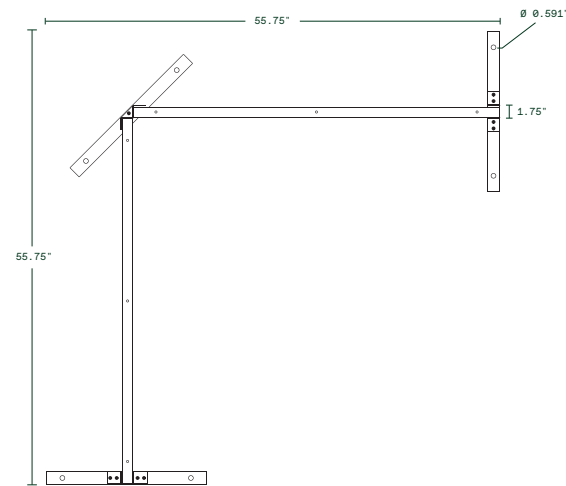

Dimensions



Button Head Hex Drive Screw  
M6x1mm Thread, 20mm Long



Hex Nut  
M6x1mm Thread

### Hardware Included

