

privacy screen series

blocks panel

(page: 1 of 5)

black 

corten steel 

*all corten steel products arrive in their raw steel (unruled) state as shown in contents page.

materials

panel is made from durable 16 gauge steel

features

- modular
- all weather resistant
- optional accessories
- 65% privacy rating
- easy installation
- various configurations

blocks panel

45" L x 1.25" W x 24" H
Weight: 13 lbs

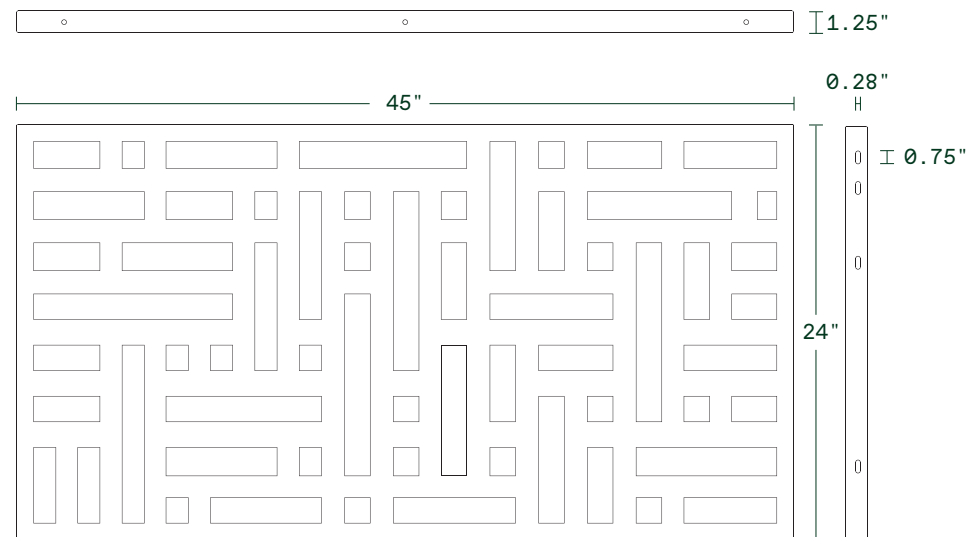
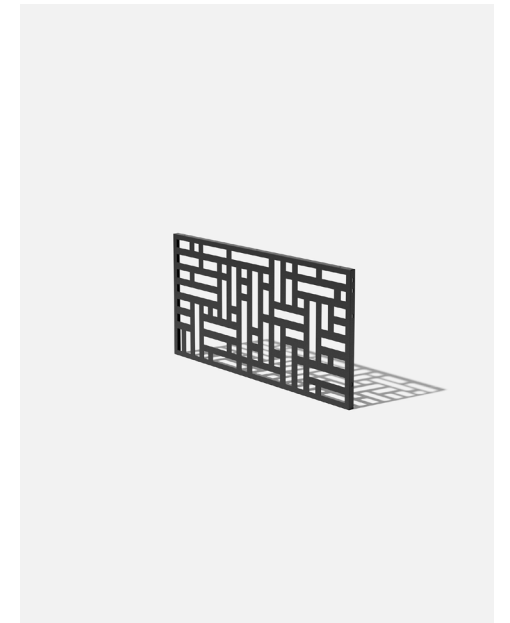
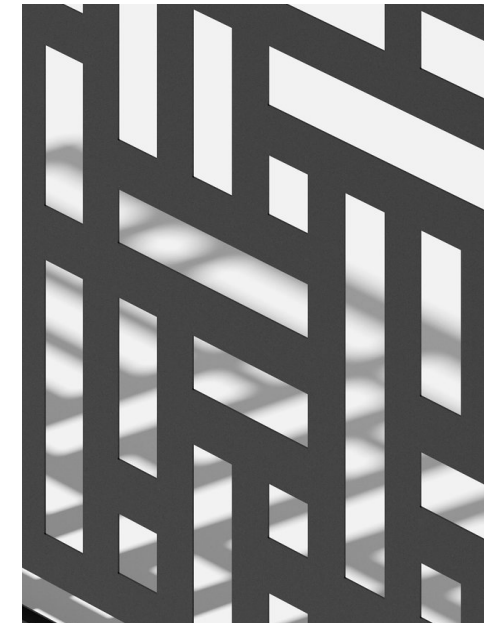

Dimensions

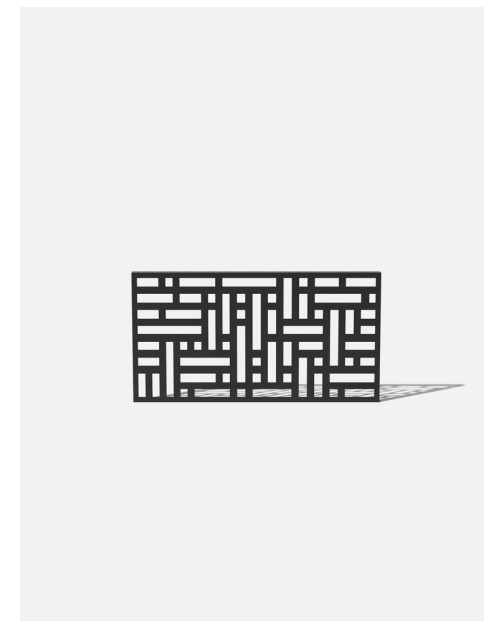

privacy screen series

blocks 2 panel set

(page: 2 of 5)

black



corten steel



*all corten steel products arrive in their raw steel (unrusted) state as shown in contents page.

materials

panel is made from durable 16 gauge steel
frame is made from durable 14 gauge steel

features

modular	65% privacy rating
all weather resistant	easy assembly
optional accessories	various configurations

notes

Though our Privacy Screens stand tall & sturdy on their own out of the box, we recommend anchoring them to the ground for added security and safety.

blocks 2 panel set

45" L x 19.75" W x 52" H

Weight: 37 lbs

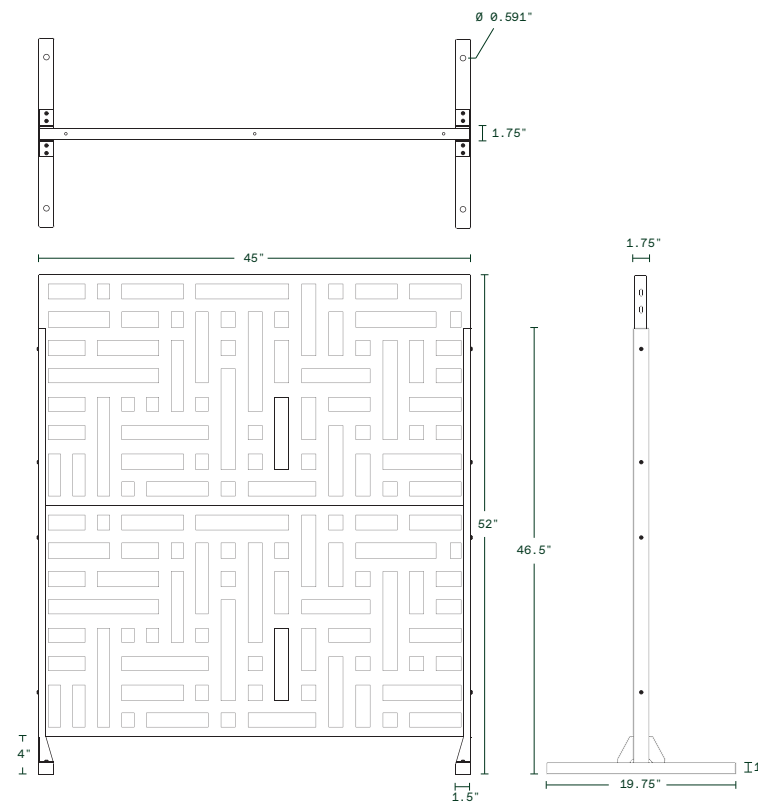

Dimensions



Button Head Hex Drive Screw
M6x1mm Thread, 20mm Long



Hex Nut
M6x1mm Thread

Hardware Included



privacy screen series

blocks 3 panel set

(page: 3 of 5)

black



corten steel



*all corten steel products arrive in their raw steel (unrusted) state as shown in contents page.

materials

panel is made from durable 16 gauge steel
frame is made from durable 14 gauge steel

features

modular	65% privacy rating
all weather resistant	easy assembly
optional accessories	various configurations

notes

Though our Privacy Screens stand tall & sturdy on their own out of the box, we recommend anchoring them to the ground for added security and safety.

blocks 3 panel set

45" L x 19.75" W x 76" H

Weight: 54 lbs

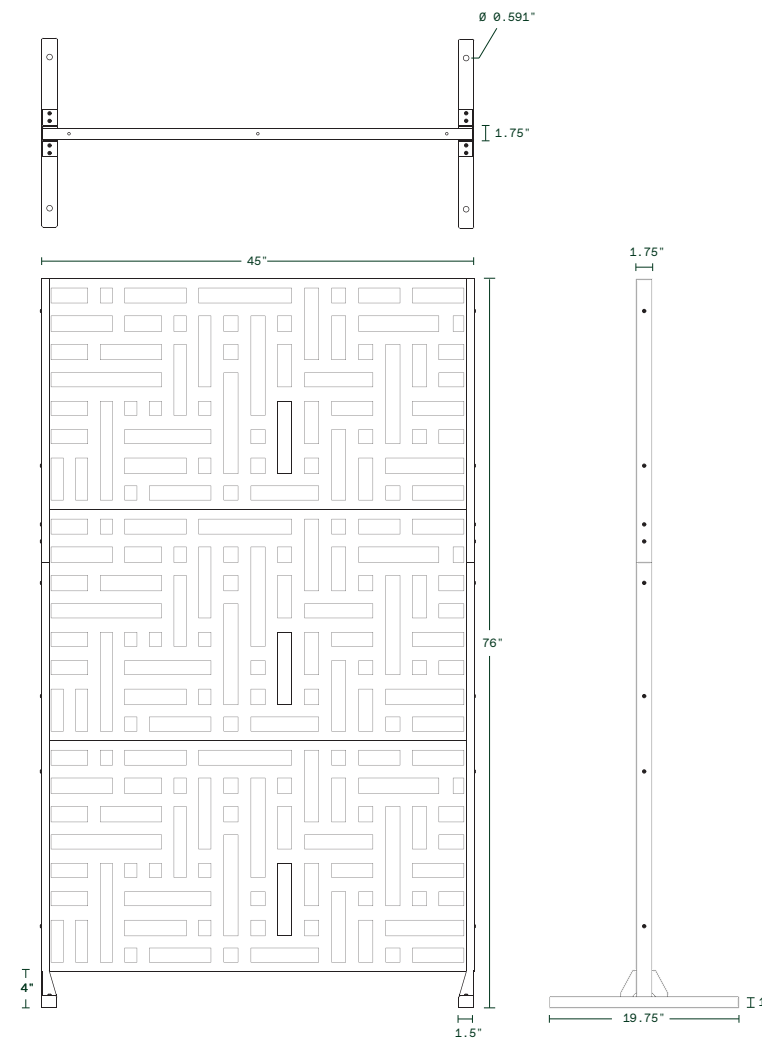

Dimensions



Button Head Hex Drive Screw
M6x1mm Thread, 20mm Long



Hex Nut
M6x1mm Thread

Hardware Included

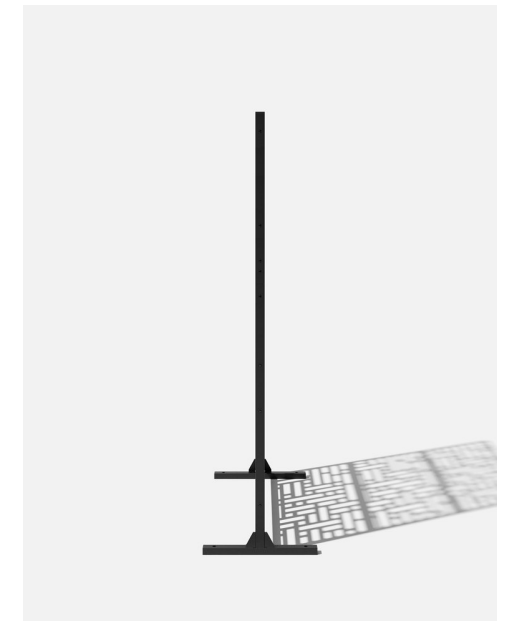

privacy screen series

blocks 4 panel set

(page: 4 of 5)

black



corten steel



*all corten steel products arrive in their raw steel (unrusted) state as shown in contents page.

materials

panel is made from durable 16 gauge steel
frame is made from durable 14 gauge steel

features

modular	65% privacy rating
all weather resistant	easy assembly
optional accessories	various configurations

notes

Though our Privacy Screens stand tall & sturdy on their own out of the box, we recommend anchoring them to the ground for added security and safety.

blocks 4 panel set

45" L x 19.75" W x 100" H
Weight: 70 lbs

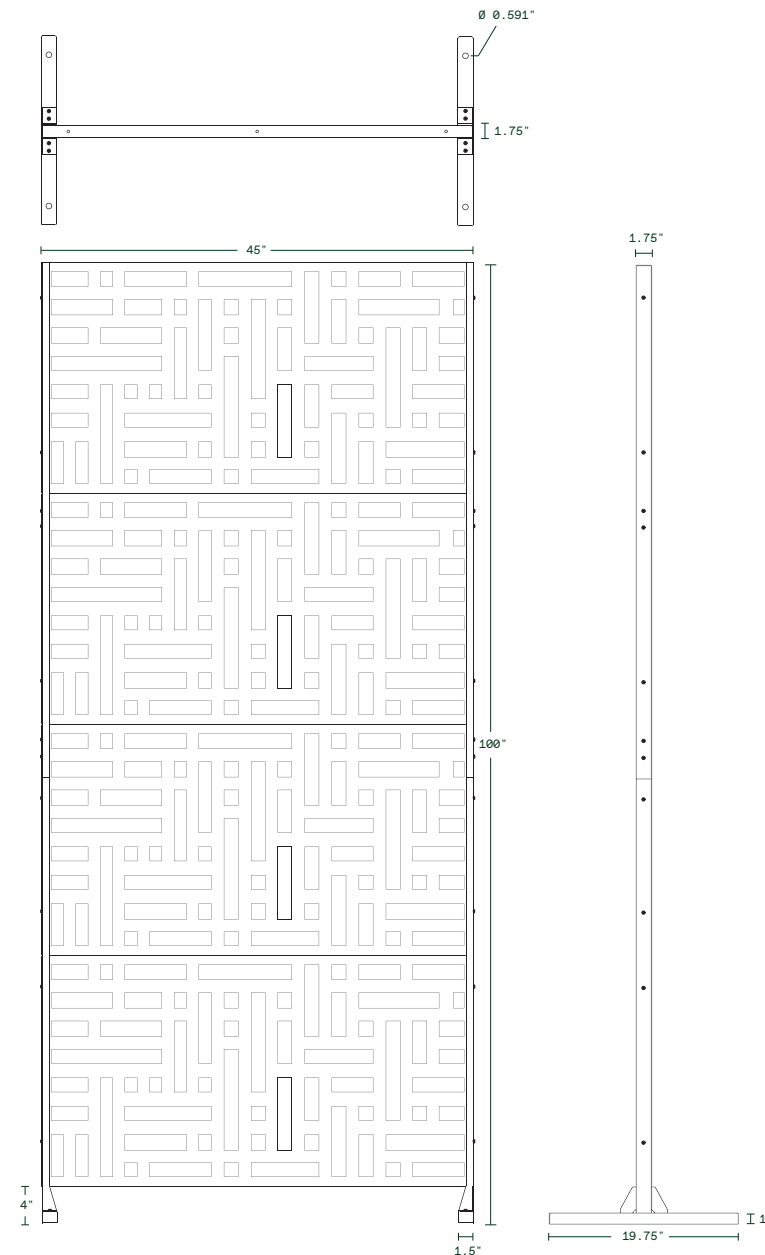

Dimensions



Button Head Hex Drive Screw
M6x1mm Thread, 20mm Long



Hex Nut
M6x1mm Thread

Hardware Included



privacy screen series

blocks corner set

(page: 5 of 5)

black



corten steel



*all corten steel products arrive in their raw steel (unrusted) state as shown in contents page.

materials

panel is made from durable 16 gauge steel
frame is made from durable 14 gauge steel

features

modular	65% privacy rating
all weather resistant	easy assembly
optional accessories	various configurations

notes

Though our Privacy Screens stand tall & sturdy on their own out of the box, we recommend anchoring them to the ground for added security and safety.

blocks corner panel set

55.75" L x 55.75" W x 76" H
Weight: 103 lbs

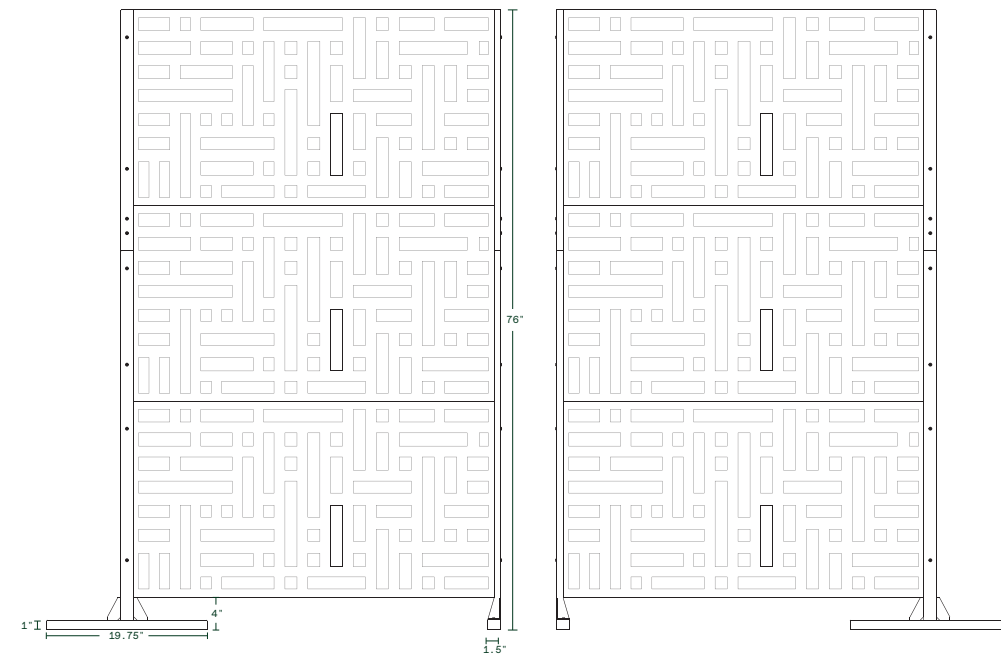
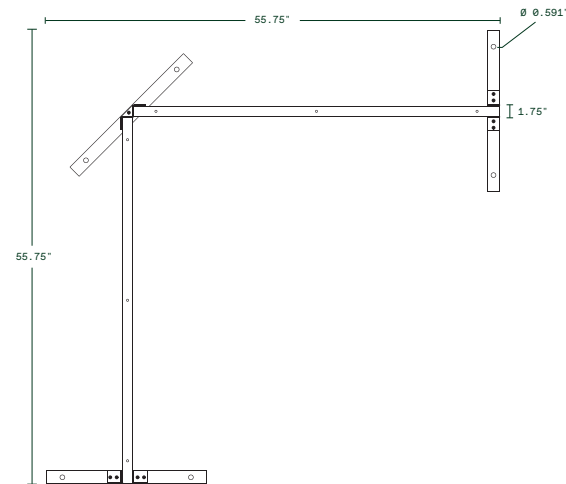

Dimensions



Button Head Hex Drive Screw
M6x1mm Thread, 20mm Long



Hex Nut
M6x1mm Thread

Hardware Included

