



VA-20R

WALL MOUNTED INFRARED HEATER

Instructions Manual

Read instructions manual before use!



Equipmart Ltd
Kiam House
Birchill Road
Knowsley Ind. Park North
Merseyside
L33 7TD

0151 548 5500
www.castleheaters.co.uk

Thank you for purchasing your new heater. These operating instructions will help you use it properly and safely, we recommend that you spend some time reading this instructions manual to fully understand all the operational features it offers. Please read all the safety instructions carefully before attempting to operate this unit and keep this instruction manual for future reference.

Safety warnings

WARNING: PLEASE REMOVE ALL PACKAGING BEFORE TURNING ON THE HEATER, NO PACKAGING MUST REMAIN TOUCHING THE HEATING ELEMENT / BULB.

CAUTION: Some parts of this product can become very hot and cause burns. Particular attention has to be given when children and vulnerable people are present.

WARNING: In order to avoid overheating do not cover the heater. It is not for drying clothes.

- Read all instructions before using this heater.
- Do not leave this unit unattended when in use.
- This heater will get hot when in use, do not touch hot surfaces.
- Do not move the unit when in use. Wait until the heater is completely cool before moving and check that it has been unplugged from the power supply.
- Position the unit at least 1m away from highly combustible materials such as furniture, trees, leaves, dry grass and bushes.
- The heater must be a minimum of 1.8m away from the ground and a minimum of 0.5m away from the ceiling of a building or overhanging item(s).
- The heater must not face with the heating element pointing upwards towards a ceiling. The heater element must be facing the area it is to heat.
- Keep children and pets at a safe distance from the unit.
- This appliance cannot be used by children and persons with reduced physical, sensory or mental capabilities.
- Children shall not play with the appliance. Cleaning and user maintenance shall not be made by children without supervision.
- Do not operate the heater if any signs of damage or malfunction manifest themselves.
- Do not attempt to repair or adjust any electrical or mechanical functions on this unit. The unit does not contain any user serviceable parts. Only a qualified electrician should perform servicing or repairs. Attempting to repair the unit yourself will void your warranty.
- If the power cable is damaged, it must be replaced by the manufacturer, its service agent or similarly qualified persons in order to avoid a hazard.
- Do not handle the element with bare hands. If it is inadvertently touched, remove finger

marks with a soft cloth and methylated spirits or alcohol, otherwise the marks will burn into the element causing premature heater failure.

- This product is suitable for indoor and outdoor use. Do not use this heater in the immediate surroundings of a bath, shower or swimming pool.
- This product must not be left outdoors exposed to the elements for long periods of time.
- Do not touch the plug with wet or damp hands.
- Do not run the power cable under carpeting. Do not cover the power cable with rugs, runner, or similar coverings. Arrange the power cable away from foot traffic and where it will not be tripped over.
- Do not wind the power cable around the unit.
- Do not insert or allow foreign objects to enter any ventilation or opening on the heater, as this may result in electric shock, fire, or damage to the heater.
- To prevent a possible fire, do not block the air vents.
- A heater has hot and arcing or sparking parts inside. Do not use in areas where petrol, paint, explosive and/or flammable liquids are used or stored. Keep unit away from heated surfaces and open flames.
- Where possible, avoid the use of an extension cable as this may overheat and cause a fire. However, if you have to use an extension cable, ensure it is suitable for the purpose, has been tested for outdoor use and preferably has an RCD device fitted or attached.
- Always ensure the heater is plugged into a suitable socket, one that is tested for outdoor use.
- To disconnect heater, turn controls to OFF, then remove plug from socket. Do not unplug by pulling on the power cable.
- Always unplug the unit and ensure the unit is completely cold before moving, cleaning or storing.
- This heater is intended for domestic use only and should not be used commercially for contract purposes. Any alternative use, not recommended by the manufacturer, may result in fire, electric shock, or injury to persons.
- The use of attachments on the heater is not recommended.
- Warning: This heater is not equipped with a device to control the room temperature. Do not use this heater in small rooms when occupied by persons not capable of leaving a room on their own, unless constant supervision is provided.
- Check exterior walls for areas of damage before installing the heater.
- Always use on a dry, suitably strong, stable, flat and level surface.
- Check exterior walls for communication and electrical cables and pipelines. Should any service lines be present in the immediate vicinity do not install your heater, find an alternative location to install this product.
- Do not position directly above or below an electrical socket.
- Do not remove any of the warning stickers or signs from the product.

Installation

Before installation, these matters need attention

- Please ensure all packaging is removed before attempting installation
- Products should be put down gently.
- Installation in acidic and alkaline environments is not recommended.
- The product must be earthed.
- The products are required to check the product brand mark on the voltage and the local voltage to ensure it conforms.
- Ensure the power rating should have sufficient current carrying capacity (if the heater trips out on initial startup it's highly likely your power source isn't adequate for the heater, we recommend you consult a qualified electrical engineer for advice on your supply).

Ensure safe installation location

For the safe use of the product, the installation position should be a minimum of 1.8m from the ground. Ceiling, roof or other coverings should be a minimum distance of 0.5m and the minimum distance with sides wall is 0.5m.

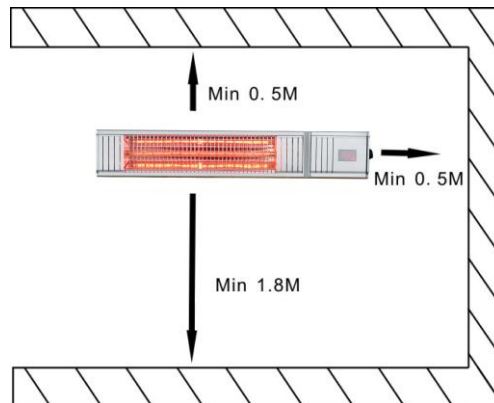

Installation steps

1. At the safe installation location, use a power drill to drill three 8 mm round holes.
2. Insert plastic raw plugs into the three holes.

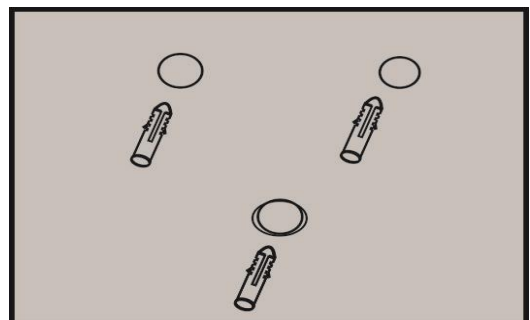
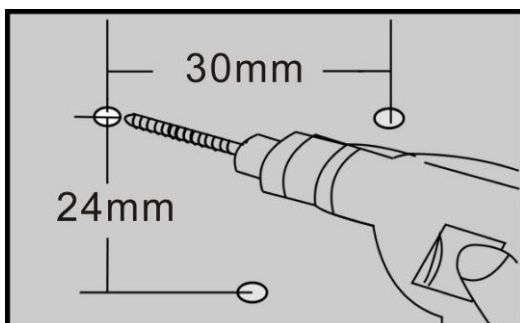

3. Fix the bracket into place by using the three ST4*35 screws and make sure the it is fixed securely.

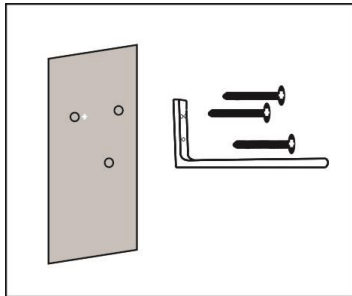

4. Before attaching the heater, make sure the power switch is on. Fix the heater onto the bracket using the two M6*14 screws and butterfly nuts

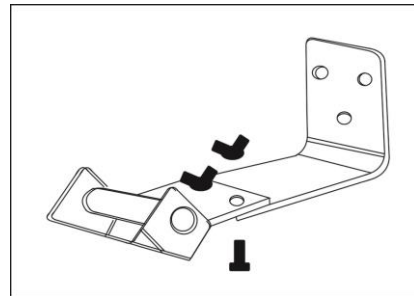

Operating Instructions

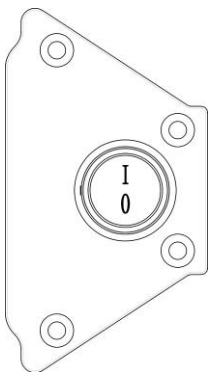

The mains power switch on right side to control power on/off. This must be switched ON in order to operate the remote control.

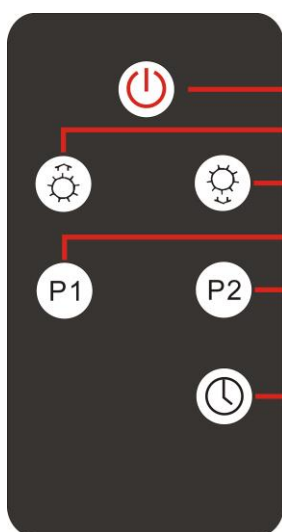

Remote Control

1. On / Off

Switches the heater on or off.

②

2. Increase Heat Setting

Increase heat mode from F1 up to F9

③

3. Decrease Heat Setting

Decrease heat mode from F9 down to F1

④

4. Medium Heating

1000W Heating Power.

⑤

5. Maximum Heating

2000W Heating Power.

⑥

6. Timer Control

Set timer between 1-24 hours

Maintenance and Cleaning

Maintenance

Attention! Careful and regular maintenance of the heater is required to attain longevity and efficient operation.

1. Check the cleanliness of the Reflector and IR-Filament at least once a month. If necessary, apply cleaning and maintenance instructions.
2. The number of checks may be increased considering the amount of the dust in the environment.
3. Check the appearance of the Reflector, Wire and Frame visually while cleaning the appliance. In case of any damage/deformation, consult a qualified technician.
4. Check the power cable and plug visually while cleaning the appliance. In case of any damage/deformation, consult a qualified technician.
5. It is recommended to change the reflector every 2 years for more efficient operation.

Cleaning

Attention! Careful and regular cleaning helps your heater operate for longer and more efficiently.

1. **Make sure the power is off**, unplug the power cable for your safety before cleaning your appliance.
2. Take out the front grid wire through the inlets on the frame using a slotted screwdriver.
3. The reflector and filament must be cleaned with a soft cloth, a smooth brush or cool or dry air. The cloth may be damp but never too wet and the cleaner should not include any chemical.
4. Refrain from using cleaning material likely to damage the reflector (cleanser etc.).
5. Insert the wire grid using a screwdriver.

Specifications

Model	VA-20R
Voltage	AC220-240V
Frequency	50/60Hz
Electric Power	2000W

Terms of Warranty

Your Castle heater is covered by a 12 months parts guarantee. Warranty by Castle Heaters does not cover the defects arising out of the improper use of the heater. The warranty does not cover the situations below:

1. The damages and defects arising out of improper use.
2. The damages and defects having occurred during the transportation after the delivery of the product to the customer by the company.
3. The damages and defects arising out of low or excessive voltage, ungrounded plug usage, faulty electricity systems, operating the appliance in different voltage values other than specified in the instructions.
4. The damages and defects arising out of fire and lightning.
5. The damages and defects arising out of repairs and maintenance by persons other than Authorized Services.
6. The defects arising out of the breach of the instructions in the manual.
7. The damages and defects arising out of the transportation of the product instead of repair.
8. The dust and polluters in the environment.
9. Damage in the reflector or filament due to faulty cleaning.
10. Faulty installation or dismantlement.
11. Operating with damaged filament, frame or power cord.

Attention! Faulty maintenance and cleaning are not covered by the warranty.

Should this product be proven defective in workmanship or material, the consumer's sole remedies shall be such repair or replacement as provided by the terms of this warranty. Under no circumstances shall Castle Heaters be liable for any loss or damage, direct, consequential, or incidental, arising out of the use of or inability to use this product.

This warranty will become void if the serial number (if applicable), model number identification, or brand have been wholly or partially removed or erased.

All products have CE/GS/EMC/ETL certificate.



The symbol on the product or in the instructions means that your electrical and electronic equipment should be disposed at the end of its life separately from your household waste.

There are separate collection systems for recycling in the EU.

For more information, please contact the local authority or your retailer where you purchased the product.

A copy of your order receipt must be included when returning to:

Equipmart Ltd
Kiam House
Birchill Road
Knowsley Ind. Park North
Merseyside
L33 7TD

Tel: 0151 548 5500

Web: www.castleheaters.co.uk