

## USER MANUAL

ULTRASONIC TOP-FILL  
COOL MIST HUMIDIFIER  
MODEL: HURON (4L / 6L)

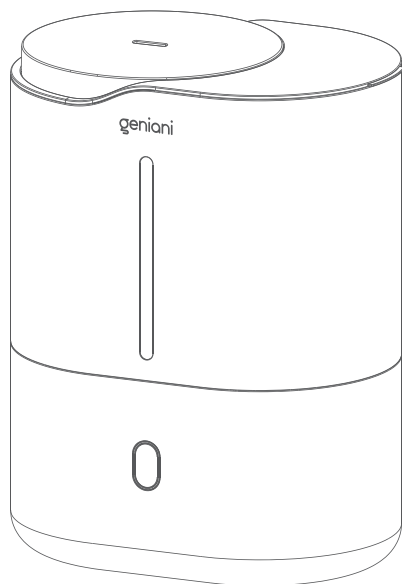

### Find Us Online

Search for **@GenianiProducts** • **#Geniani** on social media for wellness tips, special deals, giveaways, inspiration, and more.



**QUESTIONS OR  
CONCERNS?**

PLEASE CONTACT US

**1 (833) 780-5026**

Mon-Fri, 9:00 am - 5:00 pm PST/PDT  
or at [info@geniani.com](mailto:info@geniani.com)

# CONTENTS

Important Safety Instructions	3
Quick Start Guide	6
Components	7
Setting Up Your Humidifier	8
Using Your Humidifier	10
Smart Mode	13
Cleaning Your Humidifier	14
Troubleshooting	17
Specifications	19
FCC Information	20
Exception Clauses	21
Warranty	22
Customer Support	24

# IMPORTANT SAFETY INSTRUCTIONS

READ AND SAVE THESE INSTRUCTIONS

**To reduce the risk of fire, electric shock, or other injury, follow all instructions and safety guidelines.**

1. The humidifier should always be placed on a firm, flat, waterproof surface at least four feet (1.2 m) away from bedside, 12 inches (30 cm) from the wall and out of reach of patients, children and pets. Be sure the humidifier is in a stable position and the power cord is away from heated surfaces and out of the way to prevent the humidifier from being tipped over.
2. The humidifier should not be left unattended in a closed room since air could become saturated and leave condensation in front of the unit, on walls and furniture. Leave the room door partly open. Do not aim mist outlets directly at children, walls or furniture.
3. Before using the humidifier, extend the cord and inspect for any signs of damage. Do not use the unit if the cord has been damaged. Do not operate with a power cord coiled or with a twist tie in place.
4. The humidifier has a polarized plug (one blade is wider than the other) as a safety feature. This plug will fit into a polarized outlet only one way. If the plug does not fit fully into the outlet, reverse the plug. If it still does not fit, contact a qualified electrician. Do not attempt to defeat this safety feature.

# IMPORTANT SAFETY INSTRUCTIONS

## READ AND SAVE THESE INSTRUCTIONS

5. **CAUTION:** To avoid fire or shock hazard, plug the humidifier directly into a 120V AC electrical outlet. To avoid risk of fire, shock or personal injury do not use an extension cord or power strip.
6. The humidifier should always be unplugged and emptied when not in operation or while being cleaned. Shut off and unplug the humidifier before moving. Do not move or tilt the humidifier while it is in operation. Plug and unplug unit with dry hands. Never pull by cord.
7. Do not operate the humidifier without water. Turn off and unplug the unit when the tank is empty.
8. Humidifier requires regular cleaning. Refer to and follow cleaning instructions.
9. Do not operate outdoors; this humidifier is intended for indoor residential use only.
10. Not for commercial use. Household use only.
11. Do not cover or insert objects into any openings on the unit.
12. Do not block intake or output vents.
13. Do not attempt to repair or adjust any electrical or mechanical functions on this humidifier. Doing so will void your warranty.
14. Do not use other items as replacement parts for this product.

# IMPORTANT SAFETY INSTRUCTIONS

READ AND SAVE THESE INSTRUCTIONS

15. Do not place in direct sunlight, high temperature areas or near computers or sensitive electronic equipment.
16. Do not run the cord under rugs, carpets, runners, or similar coverings. Do not route the cord under furniture or appliances. Place the cord away from heavy-traffic areas where it will not be a tripping hazard.
17. Do not add any medications, oils and fragrances into mist outlet, water reservoir or water tank. Only add essential oils to the fragrance box.
18. If the humidifier is damaged or is not functioning properly, stop using it and contact Customer Support immediately (see page 24).

# QUICK START GUIDE

## BUTTON FUNCTIONS

1st Press - Smart Mode  
2nd Press - Low Mist  
3rd Press - Medium Mist  
4th Press - High Mist  
5th Press - Turn OFF  
Hold 3 sec - Tank Light  
ON/OFF

## SMART MODE

The water tank light indicates surrounding humidity levels.

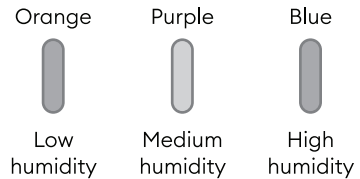

**RED LIGHT**  
Indicates  
Standby Mode



**WHITE LIGHT**  
Indicates  
Humidifier is on



**LIGHT GOES OFF**  
Automatically if no  
operation occurs  
within 40 seconds

## HOW IT WORKS

Water is released into the reservoir when the float paddle engages the plunger at the bottom of the water tank. An atomizer vibrates at ultrasonic frequency, breaking the water into a fine mist. The mist is quietly propelled by a fan up a vertical mist chamber to the mist outlet where the cool, visible mist enters the room. This humidifier will shut off when the water level is low or when the tank is removed from the base.

**If your humidifier isn't operating normally, please consult the troubleshooting guide before requesting service.**

# COMPONENTS

## PARTS' NAME

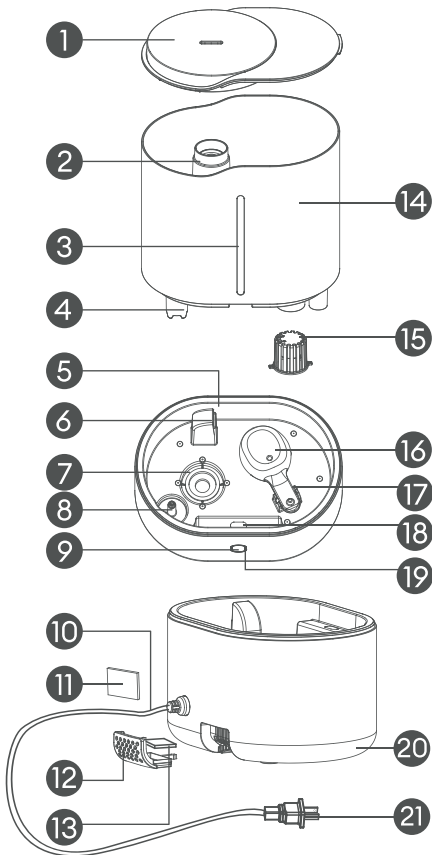

1. Top Cover
2. Mist Outlet
3. Water Gauge
4. Mist Reinforcement
5. Water Channel
6. Air Outlet
7. Atomizer
8. Float
9. Button
10. Power Cord
11. Carbon Filter
12. Fragrance Box
13. Fragrance Sponge
14. Water Tank
15. Filter
16. Float Plate
17. Supporter
18. Water Tank Light
19. Light Ring
20. Bottom Cover
21. Power Plug

**NOTE: If the structure diagram of the product is subject to change without prior notice. Please refer to the actual product.**

# SETTING UP YOUR HUMIDIFIER

UNPACK THE HUMIDIFIER. KEEP THIS INSTRUCTION MANUAL FOR REFERENCE

- 1 Take off the top cover

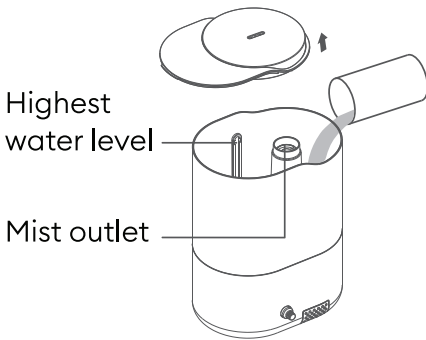

- 2 «Press-and-release» fragrance box

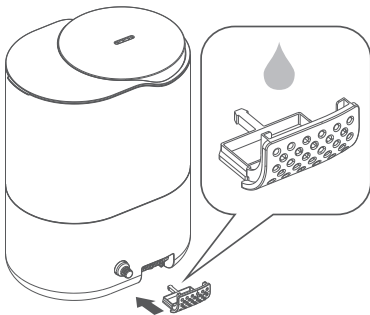

1. Remove the accessories from the box.
2. Remove the top cover (pic.1), and then take out the float plate cover in the water channel for the first use. Add water directly into the water tank and then place the cover back on the unit.

**WARNING: Never add the water directly into the mist outlet.**

3. Connect the power plug into the socket. When it is connected, the humidifier will enter standby mode.
4. In standby mode, press the button to start up the humidifier. The unit will turn on and should begin misting.



# SETTING UP YOUR HUMIDIFIER

UNPACK THE HUMIDIFIER. KEEP THIS  
INSTRUCTION MANUAL FOR REFERENCE

5. For more information about the button and light ring, please refer to the section "Operation method" on the "Using Your Humidifier" page.
6. If you want to use the fragrance function; press and then release the fragrance box to remove it (pic 2). Add 10 drops of fragrance into the fragrance sponge, and then place the fragrance box back in its compartment.
7. Mist should be directed away from walls, furniture, bedding, and appliances.

## **NOTE:**

- Never add fragrance directly into the water tank or water channel. Do not let aromatherapy oil come into contact with any other parts except the aromatherapy container to prevent damage. If aromatherapy oil has contacted other parts, clean and wipe them with a dry cloth immediately.
- To use the humidifier at night, it is recommended that you add water above 3/4 of the water tank to avoid water leaks.

# USING YOUR HUMIDIFIER

## NOTICE BEFORE OPERATION

- Suitable working environment for humidifier: 40°F - 104°F (5°C -40°C);
- Relative humidity: less than 80% RH; Use clean water below 104°F (40°C);
- When the humidifier hasn't been used for a long time, the water channel and the water tank should be cleaned before use;
- This product includes a fragrance function. If it has not been used for a long time, please clean the fragrance box before adding additional fragrance oil.

Operation or indication	Operation or indication
Connect the power plug into the socket	Standby status
Short press the button	1st Press - Smart Mode 2nd Press - Low Mist 3rd Press - Medium Mist 4th Press - High Mist 5th Press - Turn OFF
Hold the button for 3 seconds	To turn the water tank light on/off (water tank light defaults to light-up).
Light ring is red	Standby status

# USING YOUR HUMIDIFIER

## NOTICE BEFORE OPERATION

Operation or indication	Operation or indication
Light ring is white	Working status
	In Smart mode, light ring is blinking.
	In Low Mist, Medium Mist and High Mist modes, the light ring will be displayed in different brightnesses; the brighter the light ring, the greater the mist output.
Light ring is red and blinking	If it blinks twice, this indicates the level of water in the tank is too low. And at the same time, the water shortage protection has occurred. Make sure the water tank is filled with water and installed in the base. Then restart the humidifier.
Light ring goes off the color of water tank light	Light ring will go off if there is no operation in 40 seconds. Any kind of operation can wake it up.
Water tank light	The water tank light will change its color according to ambient humidity. In case of lower humidity the tank light will illuminate orange. In medium humidity the tank will illuminate purple. In high humidity the tank will illuminate blue.

# USING YOUR HUMIDIFIER

## NOTICE BEFORE OPERATION

### **NOTE:**

During operating mode, the button ring light is white. This ring light will go off if there is no operation within 40 seconds. Be advised, in certain dim room settings with poor lighting, the button may give off a rather blue light rather than white. Rest assured that this switch from white to blue is not because the ring light is blue; rather, it's the reflection of the water tank's blue light within being projected, giving it a blue color. The button ring light itself is white.

### **Hard Water and White Dust**

High mineral content in your water, also known as hard water, may cause a white mineral residue to accumulate on surfaces in the room near the humidifier. This mineral residue is commonly referred to as white dust. The higher the mineral content (hardness) of your water, the greater the potential that an ultrasonic humidifier may produce white dust. White dust is not a result of a defect or flaw in the humidifier. It is a result of the amount of minerals suspended in the water you are using.

To keep your humidifier running efficiently, clean it regularly. Weekly cleaning is recommended. All maintenance should be done in the kitchen or bathroom on a water resistant surface near a faucet.

# USING YOUR HUMIDIFIER

## SMART MODE

**NOTE:**

In smart mode, the humidifier can automatically control the mist volume and stop/resume humidification.

Smart Mode uses the humidifier's sensor to automatically adjust the mist level (or turn it off) to maintain a comfortable and healthy level of humidity. Smart Mode automatically adjusts the mist level to maintain 40–60% relative humidity. The humidifier will stop misting when the highest target humidity level 65% is reached. If the humidity drops below the target humidity level, the humidifier will begin misting again.

# CLEANING YOUR HUMIDIFIER

In some areas, water quality is harder and richer in calcium and magnesium. After using the humidifier over time, calcium and magnesium ions will be deposited on the evaporating filter core, causing it to become scaly. This decreases humidifying efficiency. In addition, the active carbon filter attached at the air inlet will accumulate a large quantity of dust over time, which also decreases humidifying efficiency.

## **The cleaning and maintenance method for the humidifier is listed below:**

1. Clean atomizer, water tank and water channel every week.
2. Replace water in the water tank frequently.
3. If you don't plan to use the humidifier for a long time, please kick the plug out at the socket, clean and dry all components, and then store the product in a cool place.

## **Cleaning method for atomizer:**

1. Inject 0.34 fl. oz. (10 ml) acetum on the surface of the atomizer (add or reduce acetum according to the severity of scaling) and immerse the atomizer for 2-5 mins.
2. Gently scrub the surface of the atomizer with the cleaning brush until the scale is removed.
3. Wash the surface of the atomizer with a wet towel.

# CLEANING YOUR HUMIDIFIER

## Cleaning method for water tank:

1. Remove all excess water from both the humidifier tank and the base.
2. Remove the top cover. You can now clean it properly (pic. 3).
3. Disconnect the filter in the water tank by turning clockwise (pic. 4).
4. Wipe disassembled components with a warm wet towel. To prevent damage to the humidifier, never rinse the humidifier base directly under water. After cleaning, reassemble the components in reverse order.
5. Add a small amount of vinegar or 5-10 drops of cleaning solution into the water tank. Then fill 1/4 of the water tank with water. Leave it for 5-10 min and then use a brush to clean the water tank.

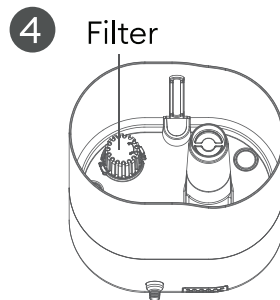
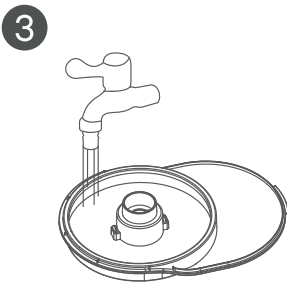

# CLEANING YOUR HUMIDIFIER

## **Cleaning method for water channel:**

1. To clean the float plate, remove the plate by sliding it toward the back of the humidifier base. Reinstall it once it is cleaned.
2. If the water channel has any water deposits, wipe it with a soft cloth dampened with water.

## **Cleaning the fragrance box:**

1. Clean the fragrance box with water and then leave it to dry.
2. Put the dry fragrance sponge back into the box then replace it with a fragrance box.

## **END OF SEASON CLEANING AND STORAGE**

Follow the cleaning instructions when the humidifier will not be used for at least one week, or at the end of the season. At the end of the season, remove any accessories and discard. Allow the humidifier and all components to dry completely before storing.

**DO NOT** store a humidifier with water inside the Reservoir or Water Tank. Pack unit safely and store in a cool, dry location.



# TROUBLESHOOTING

<b>Malfunction Phenomenon</b>	<b>Possible Cause</b>	<b>Troubleshooting</b>
The humidifier does not operate.	The power plug is not well inserted into the socket.	Insert the power plug in place.
	Low water level in the water channel.	Fill the water tank with water.
	The water tank is not installed correctly.	Install the water tank correctly.
There is a strange smell in the air.	Water is dirty or hasn't been changed for a long time.	Clean the water tank and water channel. Use clean water for humidification.
Mist output is weak.	The carbon filter at the air inlet is blocked by dust.	Clean the carbon filter at the air inlet.
There is an abnormal sound.	The device is not placed on a flat surface.	Put it on a flat and solid place or on the floor and keep it stable.
There is water around the humidifier.	The humidifier is used in a place that is not well ventilated or with high humidity. The mist does not evaporate and turns into water around the humidifier.	Turn down the humidification output (especially at night in sleep). Or you may use an air conditioner or a fan to speed up the air ventilation and improve the humidifying effect.

# TROUBLESHOOTING

Malfunction Phenomenon	Possible Cause	Troubleshooting
There is water in the water tank but the humidifier will not work.	The humidifier is tilted, resulting in low water level in the water channel. The device has switched itself off due to low water level protection.	Place the humidifier on a flat and solid place and keep it stable.
Water overflows from the water channel or the water level is too high, resulting in small humidification output and dripping noise.	The float plate, sealing part and water cover are not fixed in place.	Fix the float plate, sealing part and water cover in place.

After following the above guidelines, if the unit is still not operating normally, please contact the customer service.



## QUESTIONS OR CONCERNS?

PLEASE CONTACT US

**E-mail:** [info@geniani.com](mailto:info@geniani.com)

**Phone:** 1 (833) 780-5026

**Support Hours:** Mon–Fri,  
9:00 am–5:00 pm PST/PDT

# SPECIFICATIONS

	4L	6L
Tank Capacity	4L (1.05 GAL)	6L (1.58 GAL)
Working Voltage	100-240V	100-240V
Rated Frequency	50/60Hz	50/60Hz
Rated Power	25W	25W
Applicable Area	125 – 376 ft <sup>2</sup>	215–484 ft <sup>2</sup>
Max Mist Output	220 mL/h (+/- 80 mL)	300 mL/h (+/-80mL)
Noise Level	≤30 dB	≤30 dB
Product Dimensions	9.06" x 6.38" x 11.73"	9.06" x 6.38" x 14.29"

## NOTE:

- If the above parameters have been changed, please refer to the product.
- Mist volume will change according to indoor temperature and humidity.
- When using cold water, the humidification volume will be a little lower than the normal value. The normal volume will resume after the unit has been working for a while.

# FCC INFORMATION

**This device complies with Part 18 of the FCC rules.**

**WARNING:** Changes or modifications to this unit not expressly approved by the party responsible for compliance could void the user's authority to operate the equipment. This equipment has been tested and found to comply within the limits for Consumer ISM equipment, pursuant to Part 18 of the FCC rules. These limits are designed to provide reasonable protection against harmful interference in a residential installation. This equipment generates, uses and can radiate radio frequency energy, and if not installed and used in accordance with the instructions, may cause harmful interference with radio communications. However, there is no guarantee that interference will not occur in a particular installation.

If this equipment does cause harmful interference to radio or television reception, which can be determined by turning the equipment off and on, the user is encouraged to try to correct the interference by one or more of the following measures:

1. Reorient or relocate the receiving antenna.
2. Increase the separation between equipment and receiver.
3. Connect the equipment into an outlet on a circuit different from that to which the receiver is connected.
4. Consult the dealer or an experienced radio TV technician for help.

# EXCEPTION CLAUSES

## **Manufacturer will bear no responsibilities when personal injury or property loss is caused by the following reasons:**

1. Damage to the product due to improper use or misuse of the product;
2. The alteration, change, maintenance product with other equipment without abiding by the instruction manual of manufacturer;
3. After verification, if the defect of the product is directly caused by corrosive gas;
4. After verification, if the defects are due to improper operation during the transportation of the product;
5. After verification, if the problem or dispute is caused by the quality specification or the performance of the parts and components that were produced by other manufacturers;
6. In case of operation, repair or maintenance of the unit without abiding by instruction manual or related regulations;
7. If the damage is caused by natural calamities, incorrect environment use of force majeure.

# WARRANTY

## Terms & Policy

The product delivered to the original purchaser is warranted to be free from material and workmanship defects. The manufacturer warrants this product, under normal conditions of use, for a time period of one year from the date of the original purchase. The manufacturer guarantees, subject to verification of the defect or malfunction and proof of purchase, that any repairs, or furnish of an equal product, will be done without charge, at our option during the given warranty period.

**The product comes with no other express warranty.**

**The warranty becomes void under the following circumstances:**

- The product is modified from its original state
- The product was not used in accordance with the instruction given in the user manual
- There are damages or defects due to accident, abuse, misuse, or improper maintenance
- There are damages or defects due to servicing or repairs done by unauthorized service providers
- There are damages or defects due to commercial or rental use, or other uses for which the product is not suitable for
- There are damages or defects that exceeds the total cost of the product

Geniani warranty does not cover any indirect, incidental, or consequential damages related to the use of this product. Geniani warranty only applies to the original purchaser of the product, and

# WARRANTY

cannot be transferred to other ensuing owners.

Geniani warranty is not available to products purchased from unauthorised sellers. Our warranty only applies if the product is purchased from authorized sellers that are aligned with Geniani's quality controls. All other implied warranties are only viable during the period of this limited warranty. Geniani warranty ensures specific legal rights which vary, and may be expanded, from state to state. The exclusion or limitation of consequential or incidental damages do not apply to you, if residing in a state that doesn't allow this.

If our product is found to be defective within the given warranty period, please contact Customer Support via **info@geniani.com**.

**Disposing the product before contacting us will void the warranty.**

After our Customer Support Team approves your request, please return the product alongside the order ID and a copy of the invoice.

EXTEND YOUR  
WARRANTY BY

ONE  
YEAR

Register your product within **14 days** of purchase at **www.geniani/warranty** to extend your 1-year warranty by an additional year.



SCAN ME

# CUSTOMER SUPPORT

If you have any questions or concerns about your new product, please contact our helpful Customer Support Team

\*Please have your order invoice and order ID ready before contacting Customer Support.



## QUESTIONS OR CONCERNS?

PLEASE CONTACT US

**E-mail:** [info@geniani.com](mailto:info@geniani.com)

**Phone:** 1 (833) 780-5026

**Support Hours:** Mon–Fri,  
9:00 am–5:00 pm PST/PDT



SCAN ME

We are proud of our exquisite customer support service, treating everyone like they're part of our family.

For more information, please visit our website

**[www.geniani.com](http://www.geniani.com)**

Contact us anytime!

## GENIANI

800 Progress Center Ct, Ste 100,

Lawrenceville,

GA 30043, United States

Phone: 1 (833) 780-5026