



POWERTM
WAND
BISHOP ROTARY
EST. 2008

FULL SET

SHADER

**Interchangeable
RCA Adapter**

INTENDED FOR:

- Smooth, realistic black & grey shading
- Gentle & precise
- Fine line

Faulhaber Brushed Motor

Custom winding with built in give to allow for a softer realistic hit

Matte Black Cap & Grip

Hand Polished Grey Band

Made in the U.S.A

Aircraft Aluminum

1 Year Warranty



4.3
(110mm)

5 oz

1.24"
(31mm)

Recommended Voltage between 8.5v -10v

PACKER

**Interchangeable
RCA Adapter**

INTENDED FOR:

- Color packing, color realism, traditional color packer
- Better ink saturation
- Fine or bold lines

Faulhaber Brushless Motor

Custom winding made specifically with more torque and power

Matte Black Cap & Grip

Hand Polished Copper Band

Made in the U.S.A

Aircraft Aluminum

1 Year Warranty

Recommended Voltage between 6v -8v



4.3
(110mm)

5 oz

1.24"
(31mm)

LINER

**Interchangeable
RCA Adapter**

INTENDED FOR:

- Line work (All types)
- 3RL shading
- Black work
- Dot work

Faulhaber Brushless Motor

Custom winding made specifically
with more torque and speed

Matte Black Cap & Grip

Hand Polished Black Band

Made in the U.S.A

Aircraft Aluminum

1 Year Warranty



4.3
(110mm)

5 oz

1.24"
(31mm)

Recommended Voltage between 6v -8v

BATTERY PACK

Crisp OLED Display

Precise Voltage Output

Tactile Buttons



Ergonomic Design

Voltage Range 4.5V - 13V
Weight: 2.1 oz
Length: 2.19"
Diameter: 1.45"

BATTERY PACK SHORTY

Crisp OLED Display

Precise Voltage Output

Tactile Buttons



Ergonomic Design

Voltage Range 4.5V - 13V
Weight: 1.4 oz
Length: 1.59"
Diameter: 1.45"

ENHANCED WITH CRITICAL CORE



PRECISE VOLTAGE

No "Sag" in voltage drop during any part of the tattoo session



LOW BATTERY INDICATOR

At 5% charge life, a low battery icon is displayed along with a beep for 5 seconds at every minute



OUTPUT INDICATOR

Flashing decimal point informs user device is in use



TEMPERATURE PROTECTION

Power shuts off if temperature ever reaches at unsafe levels (176°F)



CRITICAL CORE

Smart & accurate



VERSATILE CHARGE CONNECTION

Easy charge connection with any USB-C connection

HOW TO USE:

- 1 Attach power pack to tattoo machine
- 2 Turn device on by holding power button 3 seconds
- 3 Select desired voltage by using +/- button
- 4 Start device by clicking power button 1 time
- 5 Stop device by clicking power button 1 time
- 6 Turn device off by holding power button 3 seconds

OLED SCREEN

WHEN CHARGING

- Screen will remain on while charging, will display battery status
- Screen will idle once fully charged after 60 seconds

CHARGING

- Use USB Type C Connector
- Universal Battery Dock

COMPATIBLE PRODUCT

(SOLD SEPARATELY)

CRITICAL CONNECT™ FOOT SWITCH



HOW TO PAIR

BATTERY TO FOOT SWITCH

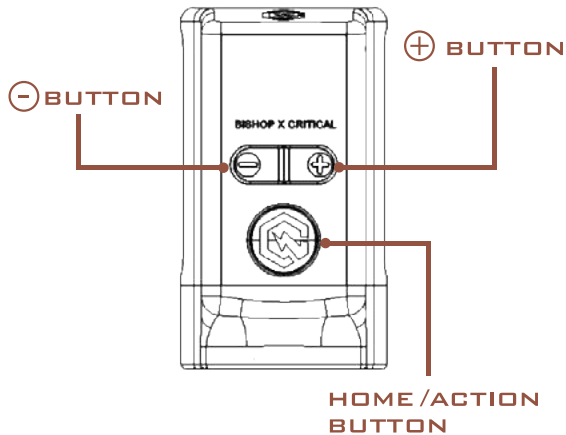

BATTERY PACK

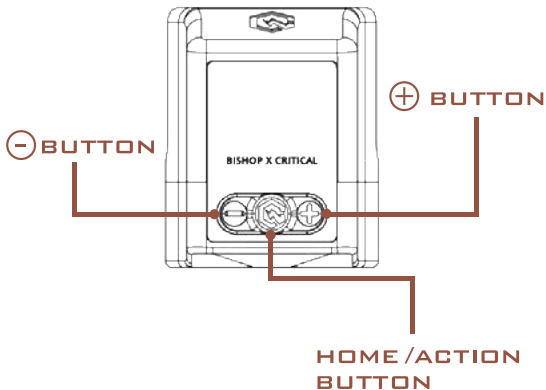

BATTERY PACK SHORTY



- Any Critical Connect Battery (up to 4)
- 1x Critical Connect Foot Switch

- 1 Hold both  and  Buttons for 3 seconds to enter Bluetooth Menu
- 2 Click  1 time for Search Mode
- 3 Quickly tap Foot Switch (sold separately) 1 time to pair with battery pack
- 4 Click Button  1 time to return to Home Menu

BLUETOOTH MENU SYMBOLS



NOT PAIRED

Click  once to search for Critical Connect Foot Switch



SEARCH MODE

Tap Foot Switch once during search mode to connect



DEVICE NOT FOUND

If no device is paired or found after 30 seconds



BLUETOOTH PAIRED

Successfully paired

Click  once to unpair device

HOME SCREEN

BATTERY TO FOOT SWITCH

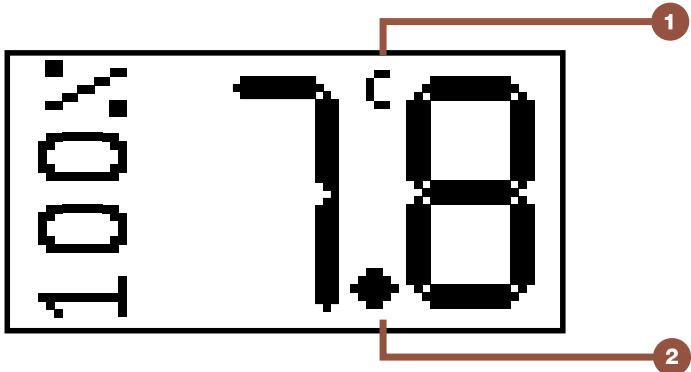

1 CRITICAL CONNECT INDICATOR

"C" Symbol will be visible on home screen when battery is paired with Foot Switch

2 MOMENTARY/CONTINUOUS MODE

Click both the ⊕ and ⊗ once to toggle between modes on the Foot Switch

◆ Solid decimal for continuous

◇ Hollow decimal for momentary

HOW TO PAIR

MULTIPLE BATTERIES

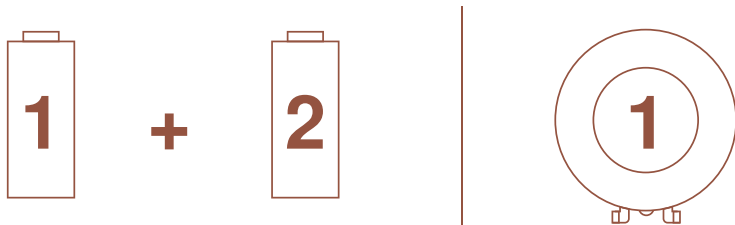

- 1 Pair 1st battery to Foot Switch
- 2 Double click (Ⓢ) to enter “standby” mode
- 3 Turn on or exit standby by double clicking (Ⓢ) on 2nd device
- 4 Pair 2nd battery to Foot Switch

Pair and switch between up to 4 batteries and 1 Foot Switch

Only 1 battery can be operated at a time per Foot Switch. All batteries not in use should be on standby mode or off.

FULL SET INCLUDES

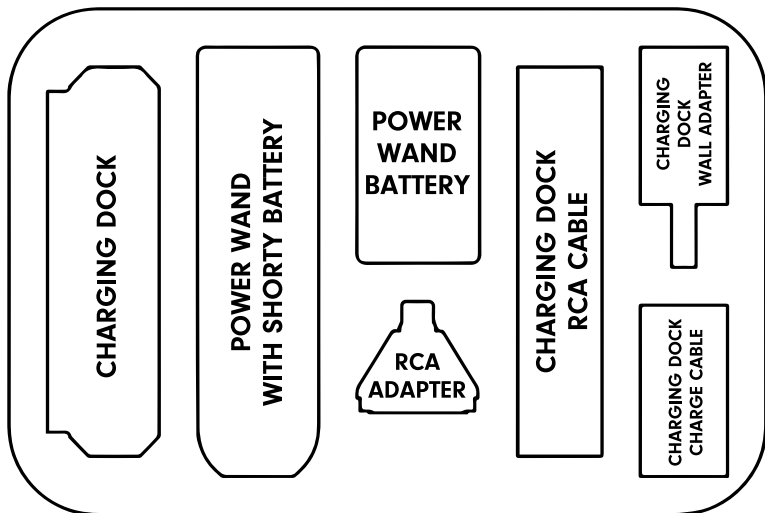

CARE & INSTRUCTIONS

OVER LUBRICATION VOIDS WARRANTY

Lubrication Instructions: www.youtube.com/bishoprotary

Determine what feels right to you as the artist. Remember with any new machine, it's going to take a few tattoos to get used to. Continue using this machine, and like tons of artists, you'll agree that this machine will quickly become one of your favorites.

FOR QUESTIONS, HOW TO VIDEOS, & WARRANTY PLEASE VISIT



BISHOPROTARY

BISHOPTATTOOSUPPLY.COM

VIDEO TUTORIAL



CREATE  MAGIC.

CREATE MAGIC.

Located in Southern California, Bishop Rotary has been the leader in Rotary Tattoo Machines since 2008.

As a tattooer with over 25 years of experience, Franco Vescovi started machine building in 1993. This was done by taking apart a tape player to build his first rotary machine with his brother using parts from local hardware store. In 2008, Franco revisited the idea of machine making - to see how it could be done better - when he created the first Bishop Rotary. This was at a time when only a few rotary companies existed in the world.

In an industry that was once dominated by coil machines, Bishop Rotary had the goal to create a better machine by using precision designed parts along with the finest motors in the world. Franco felt the performance of the rotary machine was superior because of the consistency in the hit from the motor and less trauma to the skin. He also believed the lightweight machines would combat carpal tunnel syndrome and help artists worldwide tattoo longer without pain.

Today, Bishop Rotary consists of Franco and his amazing team of machine builders, engineers, and dedicated staff, all who work tirelessly to provide tattoo machines and innovative products that meet the demands of our artists while enhancing the experience for your clients. Bishop Rotary is a true artist-owned company that knows what you need and we are honored to provide it.

THANK YOU KINDLY

Franco Vescovi

POWERED BY
CREATIVE FORCES



PATENT INFO

US PATENT 10471246, 29/736,884

AU PATENT 2019359618

CN PATENT 202030297770.3

CA PATENT 196581

Additional US, AU, CN, CA, EU Patents Pending

