

INFIRAY OUTDOOR

RICO MICRO SERIES

Multi-function Thermal Imager



WARNING! ITAR REQUIREMENTS

These products may be subject to export and foreign trade control laws of the United States and may not be exported without prior approval of the U.S. Department of State. Learn more at irayusa.com/ITAR.

FCC ID 2AY3N-AP6214A

This device complies with part 15 of the FCC Rules. Operation is subject to the following two conditions: (1) This device may not cause harmful interference, and (2) this device must accept any interference received, including interference that may cause undesired operation.

CAUTION: Changes or modifications not expressly approved by iRayUSA could void the user's authority to operate the equipment.

NOTE: This equipment has been tested and found to comply with the limits for a Class B digital device, pursuant to part 15 of the FCC Rules. These limits are designed to provide reasonable protection against harmful interference in a residential installation. This equipment generates, uses and can radiate radio frequency energy and, if not installed and used in accordance with the instructions, may cause harmful interference to radio communications. However, there is no guarantee that interference will not occur in a particular installation. If this equipment does cause harmful interference to radio or television reception, which can be determined by turning the equipment off and on, the user is encouraged to try to correct the interference by one or more of the following measures:

- Reorient or relocate the receiving antenna.
- Increase the separation between the equipment and receiver.
- Connect the equipment into an outlet on a circuit different from that to which the receiver is connected.
- Consult the dealer or an experienced radio/TV technician for help.

This device was tested for typical body-supported operations and use. Third-party belt-clips, holsters, and similar accessories used by this device should not contain any metallic components. Body accessories that do not meet these requirements may not comply with RF exposure requirements and should be avoided. Use only the supplied or an approved antenna.

TABLE OF CONTENTS

1. Overview	2
2. Features	2
3. Tech Specs	3
4. Accessories	4
5. Components and Controls	5
6. Description of Control Buttons and Shortcuts	6
7. Quick Start Guide	8
8. Charging the Batteries	10
9. Inserting a Battery	10
10. Removing a Battery	10
11. Battery Safety Precautions	11
12. Mounting the MICRO	12
13. Selecting a Working Mode	16
14. Operating Instructions	18
15. Zeroing the MICRO	22
16. Non-uniformity Correction	23
17. Photography and Video Recording	24
18. Accessing Internal Memory	25
19. Video Output	26
20. Wi-Fi Connection	27
21. Digital Zoom	29
22. Adjusting Screen Position	29
23. Menu Options and Descriptions	31
24. Warranty	50
25. Basic Inspection	51
26. Basic Care and Maintenance	51
27. General Troubleshooting	52

1. OVERVIEW

Rugged Infrared, Compact Optic

The RICO MICRO Series is an advanced optoelectronic device miniaturized to deliver remarkably versatile functionality: use on both a helmet and a weapon. Weighing in at less than a pound, the MICRO will fit in the palm of your hand and can be used with standard dovetail helmet mounts or rifle-mounted as a standalone or a clip-on optic. InfiRay Outdoor is blazing a new trail with features never-before-seen in a helmet-mounted thermal, such as onboard recording, onboard video play-back, and an HD AMOLED display. The MICRO also features InfiRay's latest high-performance 640×512, 12 μm sensor technology, MATRIX III processing, and a manual-focus f/1.0 objective lens to create an image that is unlike anything in its class.

2. FEATURES

- High-performance 12μm iRay MICRO II thermal sensor
- High-resolution AMOLED display
- 1× to 4× variable digital zoom magnification
- 1375 yard detection range
- 50 Hz image refresh rate
- 64 GB internal storage
- Record up to 1600 images and 40 hours of video
- Wi-Fi module for external connectivity to mobile app
- Digital compass
- Defective pixel correction
- Extended eye relief
- Lightweight and compact design

3. TECH SPECS

RICO MICRO SERIES	RH25	RL25
SENSOR		
Resolution	640×512	384×288
Pixel Size	12 μm	
Frame Rate	50 Hz	
Image Processing	MATRIX III	
Core	iRay MICRO II 640	iRay MICRO II 384
OPTICS		
Objective Lens	25mm/f1.0	
Magnification	1×	2×
Digital Zoom	4×	
Field of View	17.5° × 14.0°	10.5° × 7.9°
Detection Range	1375 yds	
Display Type	AMOLED	
Display Resolution	1024×768	
Imaging Modes	White Hot, Black Hot, Red Hot, Color	
Reticle Types	7	
Reticle Colors	Black, White, Red, Green	
Mounting System	MUM rail/Picatinny STD-1913 rail, PICTAIL optional	
Working Modes	Standalone, Handheld, Helmet, and Clip-on	Standalone, Handheld, and Helmet
P.I.P	No	
Rangefinder	No	
Eye Relief	35mm	
Diopter Range	-4 to +4	
ELECTRONICS		
Onboard Recording	Video and Image	
Onboard Storage	64 GB	
Wireless Connectivity	Video and Image via App	
Data Connector	Data Cable with USB, BNC, and 7-Pin Connectors	
Power Supply	18650 Battery, >4 Hours	
Start Up Time	<10 Seconds, Instant from Standby	
PHYSICAL		
Size	4.52" × 2.55" × 1.88"	
Weight	12.7 oz	
Housing Color	RH25: Flat Dark Earth (H-265) / RL25: Black	
ENVIRONMENTAL/WARRANTY		
Warranty	5 Years	
Housing Material	Aluminum	
Ingress Protection	IP67	
Operation Temperature	-4°F ~ 122°F	
Max. Recoil	1000 g/s ² (300 Win./7mm Mag)	

4. ACCESSORIES

The RICO MICRO Series ships with everything you need to get out and hunt. The included items are as follows:

- RICO MICRO Series Multi-function Thermal Imager
- Lens Cap
- Eyecup, Long
- Eyecup, Short
- 18650 Batteries (2)
- Battery Charger
- OEM Helmet Adapter Rail
- OEM Rifle Mount
- Data Cable
- User Manual
- Lens Cloth
- Soft Case
- Micro-USB Charging Cable
- USB Wall Adapter
- M4×8mm Flat Head Screws (2)
- M4×6mm Socket Head Screws (2)
- 2.5mm Hex Key
- 3mm Hex Key
- Battery Cap for Short 18650 Battery



Optional Accessories

Optional accessories for the RICO MICRO Series are available to customize your experience.

PART NUMBER	DESCRIPTION
IRAY-AC36	ADM RICO MICRO MQD Mount
IRAY-AC42	RICO MICRO Objective Lens Cattail Lever
IRAY-AC52	RICO MICRO PICTAIL Helmet/Weapon Shoe
IRAY-AC53	RICO Obverse MICRO Helmet Shoe

5. COMPONENTS AND CONTROLS

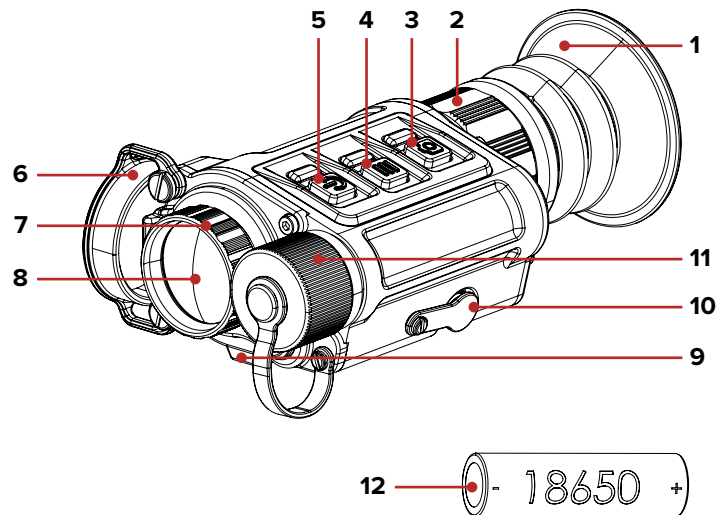

- 1 Eyecup
- 2 Eyepiece/diopter adjustment ring
- 3 Photo button
- 4 Menu button
- 5 Power button
- 6 Objective lens cover
- 7 Objective lens focus ring
- 8 Objective lens
- 9 Mount interface
- 10 7-pin female port for data cable
- 11 Battery cover
- 12 18650 battery

6. DESCRIPTION OF CONTROL BUTTONS AND SHORTCUTS

Power Button 		
Current Screen / Menu or Device Status	Short Press	Long Press
Device off	---	Power on the device
Home screen (in standalone or handheld mode)	Adjust digital zoom	Turn off the device
Any menu or full-screen interface	Toggle through menu options	---
Full-screen interfaces (defective pixel, reticle position, and screen position in helmet and clip-on mode)	Move cursor 1 pixel in the negative direction	Move cursor 10 pixels in the negative direction

Menu Button 		
Current Screen / Menu	Short Press	Long Press
Home screen	Enter menu	Switch working mode
Main menu	Select	Save and return to previous



Power + Menu Button  + 		
Current Screen / Menu	Short Press	Long Press
Home screen	Turn standby mode on / off	---
Home screen (in helmet or clip-on mode)	---	Adjust X/Y position of screen







Photo Button 		
Current Screen / Menu	Short Press	Long Press
Home screen	Take photo	Record video on / off
Any menu or full-screen interface	Toggle through menu options	---
Full-screen interfaces (defective pixel, reticle position, and screen position in helmet and clip-on mode)	Move cursor 1 pixel in the positive direction	Move cursor 10 pixels in the positive direction

Photo + Menu Button  + 		
Current Screen / Menu	Short Press	Long Press
Home screen	Perform manual non-uniformity correction (NUC)	Perform background non-uniformity correction (NUC) ¹

Power + Menu + Photo Button  +  + 		
Current Screen / Menu	Short Press	Long Press
Main menu (in standalone or handheld mode)	---	Enable/disable the reticle ² (switch between handheld and standalone modes)

1. Close the lens cover (6) before performing a background NUC.
2. See Selecting a Working Mode on page 16.

7. QUICK START GUIDE

Step 1: Unbox the RICO MICRO Series

1. Compare the box contents to the accessories list and examine each for any shipping damage. See **Accessories** on page 4.
2. Check the lens to ensure there are no smudges or dirt present. Clean with the included lens cloth, if necessary.

Step 2: Charge and Install the Battery

1. Charge the batteries before using the MICRO for the first time. See **Charging the Batteries** on page 10.
2. Open the battery cover (11) and install a battery (12). See **Inserting a Battery** on page 10.

Step 3: Mount the MICRO (Optional)

1. Install the desired eyecup (1). The longer eyecup is recommended for handheld and standalone mode, the shorter is recommended for helmet and clip-on mode.
2. Mount the MICRO to the weapon or helmet. See **Mounting the MICRO** on page 12.

Step 4: Turn On the MICRO and Adjust the Focus

1. Open the lens cover (6).
2. Long press **Power** (⏻) for 4 seconds to power on the MICRO. The iRayUSA logo will appear.
3. Rotate the diopter adjustment ring (2) of the eyepiece until the interface icons are clearly visible.
4. Rotate the objective lens focus ring (7) to focus on the object being observed.

WARNING: Do not point the objective lens toward intense energy sources, such as the sun. This may render the electronic components inoperative. The warranty does not cover damage caused by improper operation.

Step 5: Activate the Reticle (Optional)

In order to use the reticle in standalone mode (direct-aim), it must first be activated.

1. From the home screen, short press **Menu** (☰) to enter the main menu.
2. Press **Power** (⏻), **Menu** (☰), and **Photo** (📷) simultaneously for 2 seconds to activate the reticle.

NOTE: The reticle will not be visible until the default brightness of 0 is changed. See **Step 7: Set up the Reticle** below.

3. The working mode, shown at the left side of the status bar at the top of the screen, changes from handheld mode (👉) to standalone mode (📷/📷).

Step 6: Adjust the Image-View

1. Select the working mode: handheld, standalone, helmet, or clip-on. See **Selecting a Working Mode** on page 16.
2. Set the digital zoom: 1×, 2×, or 4×. Digital zoom is disabled in helmet and clip-on modes. The default is 1×. See **Digital Zoom** on page 29.
3. Select the imaging mode: white hot, black hot, red hot, or color. The default is white hot. See **Imaging Mode** on page 32.
4. Select the image brightness: 0–9. The default is 5. See **Image Brightness** on page 32.
5. Select the contrast: 0–9. The default is 5. See **Contrast** on page 33.
6. Select the screen brightness: 0–9. The default is 5. See **Screen Brightness** on page 33.
7. Select the desired non-uniformity correction (NUC) mode: automatic, manual. The default is automatic. See **NUC Mode** on page 42.
8. Calibrate the digital compass. See **Digital Compass** on page 43.
9. Set the date and time. See **Set Date/Time** on page 47.

Step 7: Set Up the Reticle (Optional)

The reticle is only enabled in standalone mode. To adjust the following settings, ensure standalone mode is selected.

1. Select the units of measure: meters or yards. The default is meters. See **Unit Selection** on page 42.
2. Select the zeroing profile. See **Zero Profile** on page 43.
3. Select the reticle style: 1–7. The default is 2. See **Reticle Style** on page 35.
4. Select the reticle brightness: 0–6. The default is 0. See **Reticle Brightness** on page 36.
5. Select the reticle color: white, black, red, and green. The default is white. See **Reticle Color** on page 36.
6. Select the zero distance. See **Zero Distance** on page 37.
7. Zero the reticle, if desired. See **Reticle Zero Setting** on page 38.

8. CHARGING THE BATTERIES

The MICRO Series comes with two rechargeable 18650 li-ion batteries, a battery charger, and a USB charging adapter. Ensure the battery is fully charged before using the MICRO for the first time.

To charge the battery.

1. Insert the battery (12) into the battery charger according to the polarity markings on the inside of the charger.
2. While charging, the three blue LEDs on the charger will flash, indicating the current charge level. When the battery is fully charged, all three blue LEDs will remain lit.

It takes about 5 hours to fully charge the battery. Each battery supports a run time of approximately 4 hours. See **Battery Status** on page 18 for additional battery information.

9. INSERTING A BATTERY

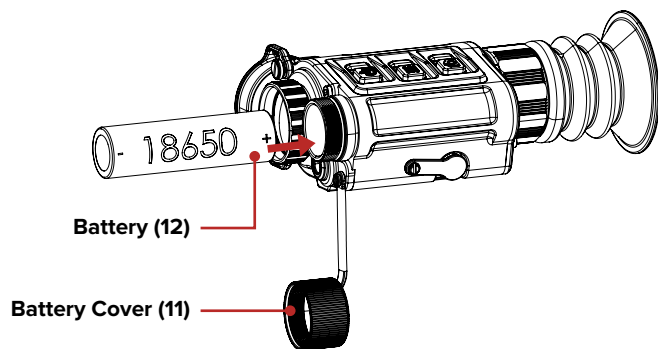

1. Rotate the battery cover (11) counterclockwise to remove it.
2. Insert a 18650 battery (12) into the battery compartment following the polarity markings inside the compartment. The positive [+] battery terminal faces in and the negative [-] terminal faces out.
3. Replace the battery cover.

NOTE: In order to accommodate variations in 18650 battery length, two battery covers are included. If using a shorter 18650 battery than provided, please use the shorter cover to ensure reliable operation.

10. REMOVING A BATTERY

1. Ensure the MICRO is powered off before removing the battery.
2. Rotate the battery cover (11) counterclockwise to remove it.

11. BATTERY SAFETY PRECAUTIONS

Only use the included battery charger to charge the batteries. Only use the battery charger with a standard USB adapter (5V–2A), as included in the package. Using any other types of adapters may lead to irreversible damage to the battery, adapter, or the MICRO. This damage is not covered under warranty.

WARNINGS:

- Only use 18650 batteries to power the MICRO.
- Do not leave the battery charger unattended while charging.
- Do not use any charger that has been modified or damaged.
- Charge the battery at a temperature range from 30°F to 100°F, otherwise the battery life will be reduced significantly.
- Avoid leaving the battery in the charger for extended periods after it has been fully charged.
- Charge the battery before it reaches <5% (the battery icon in the status bar will flash red) to avoid over-discharge and potential damage to the battery.
- Don't charge an extremely cold battery without bringing it into a warm environment. Let the battery warm up for 45 minutes before charging.
- If storing for an extended period of time, remove the battery from the MICRO and store both in a cool, dry location.
- Remove the battery and store the MICRO in the soft-sided case to protect it during transport.
- Avoid storing a fully charged or discharged battery for extended periods.
- If a battery has been used, stored, or charged for a long period of time it can begin to deteriorate. Stop using and remove the battery immediately with any battery discoloration or deformation, overheating, strange odors, or other unusual states.
- Do not drop, puncture, cut, or short-circuit the batteries.
- The recommended operation temperature range for MICRO is -4°F to 122°F. Operating outside of this temperature range may shorten battery life.
- When operating the MICRO at subzero temperatures, the capacity of the battery will decrease. This is considered normal operation and should not be considered a defect.

12. MOUNTING THE MICRO

Mounting on a Helmet

The RICO MICRO Series can be mounted to a helmet using the helmet adapter rail (included) and additional MUM-14 style interface hardware (not included), or with the optional PICTAIL system. See **Selecting a Working Mode** on page 16 for more information on helmet mode.

NOTE: Torque all hardware to a maximum of 15 inch pounds (in/lbs) unless noted otherwise. **Please note, torque is inch pounds, NOT foot pounds.** If you do not have a torque wrench, apply until snug. Do not over-tighten. No threadlocker is required for proper use; but if you do decide to use a threadlocker, use only a small amount of low-strength LOCTITE 222.

MOUNTING WITH THE OEM HELMET ADAPTER

1. Install the OEM helmet adapter rail onto the MICRO mount interface (9) using the two included M4×6mm socket head screws.

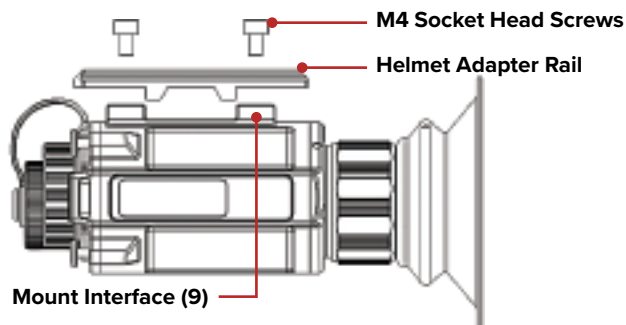

2. Finish mounting to your helmet with compatible MUM-14 style interface hardware.

MOUNTING WITH THE OPTIONAL PICTAIL SHOE

1. Install the PICTAIL shoe (IRAY-AC52) onto the MICRO with the narrow end of the dovetail facing towards the MICRO eyepiece as shown below.

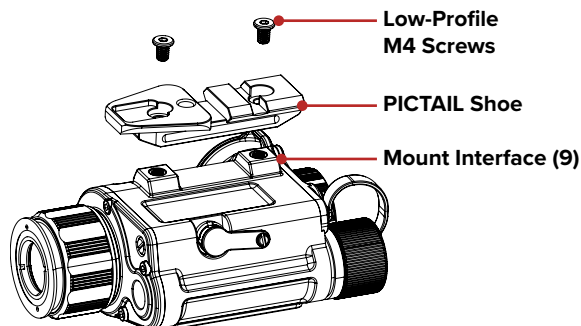

2. Thread in the low-profile M4 screws included with the PICTAIL shoe to 15 in/lbs.
3. Finish mounting to your helmet with compatible dovetail-style helmet interface hardware.

MOUNTING WITH THE OPTIONAL OMS OBVERSE MICRO HELMET SHOE

1. Place the OMS Obverse MICRO Helmet Shoe (IRAY-AC53) on the MICRO with the narrow end of the dovetail facing towards the MICRO eyepiece as shown below. Notice the two front and one rear in-body screws that correspond to the openings in the OMS Shoe (see below).

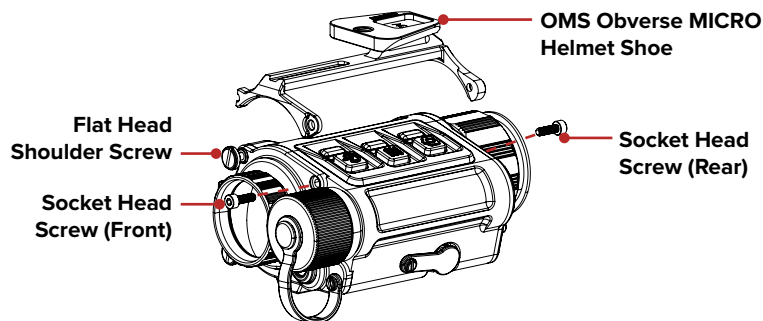

2. Remove the socket head screws using a 2mm hex key but leave the flathead shoulder screw installed.
3. Apply the OMS and re-install the socket head screws through the screw holes in the OMS Shoe.
4. Tighten until snug, taking care to not damage the threads in the body of MICRO.
5. Finish mounting to your helmet with compatible dovetail-style helmet interface hardware.

Mounting on a Weapon

The MICRO may be used with (clip-on mode) or without (standalone mode) a riflescope. See **Selecting a Working Mode** on page 16.

CAUTION: Before attempting to install your RICO MICRO on a weapon, please guarantee that your firearm is unloaded, and the muzzle is pointed in a safe direction.

NOTE: Torque all hardware to a maximum of 15 inch pounds (in/lbs) unless noted otherwise. **Please note, torque is inch pounds, NOT foot pounds.** If you do not have a torque wrench, apply until snug. Do not over-tighten. No threadlocker is required for proper use; but if you do decide to use a threadlocker, use only use a small amount of low-strength LOCTITE 222.

MOUNTING WITH THE OEM RIFLE MOUNT

1. Install the OEM Rifle Mount onto the MICRO mount interface (9) as shown below using the included two M4×8mm flat head screws.

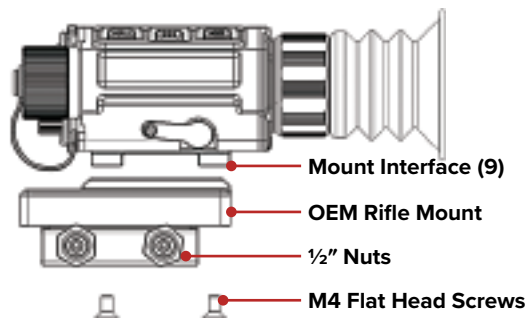

2. Torque the M4×8mm flat head screws until snug with the included hex key or to 15 in/lbs with a torque wrench.
3. Place the MICRO on your weapon and adjust tension of the 1/2" nuts on the left side of the mount to 20 in/lbs.

NOTE: The OEM Rifle Mount is spring-loaded and features a built-in shock-reduction system. Front-to-back movement is a normal part of its design and will not impact accuracy.

MOUNTING WITH THE OPTIONAL PICTAIL SHOE AND MQD RIFLE MOUNT

The PICTAIL and MQD mount work in tandem to achieve an adjustable footprint on any standard picatinny rail. In standalone mode they produce over 4.5 inches of rear offset for proper eye relief. When reversed for use in clip-on mode the MQD and PICTAIL shrink the rear offset to just 1.5 inches. In clip-on mode the required forward rail space is just 4 rail slots in front of a day optic making the PICTAIL and MQD the perfect combination for shorter platforms like SBRs and pistols.

1. Install the PICTAIL shoe to the MICRO. See **Mounting with the Optional PICTAIL Shoe** on page 12.
2. Unlock the MQD mount by depressing the lock button on the tension lever and swinging 180° to the open position.
3. Install the MQD onto the rail of your weapon and move the lever to the locked position.
4. Finally, check the tension required to lock the tension lever. To adjust the tension:
 - a. Move the lever to the open position and push the lever toward the base. This will make the adjustment nut protrude on the opposite side of the base.
 - b. With the nut protruding, it may be turned to the right or the left to make the necessary adjustment. You will need NO tools for this step.

NOTE: The amount of tension you set will depend on your personal preference. You should not have to fight to open or close the tension lever; you should be able to move it easily with one hand.

NOTE: If tension adjustments are needed between the PICTAIL Shoe and the MQD, please follow the tension adjustment instructions on the previous page.

5. Mount the MICRO to the MQD:

- a. For standalone weapon optic use, mount the MICRO to the MQD, oriented so that the MQD is extending past the front of the objective lens as shown below.

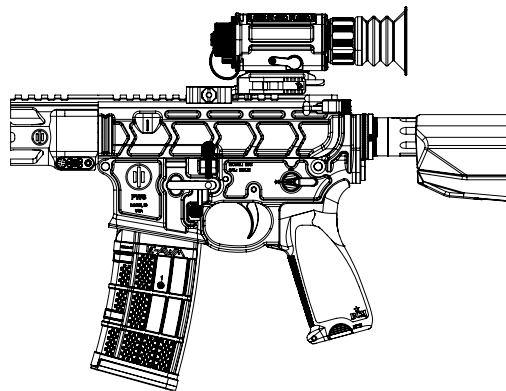

- b. For clip-on use, mount the MICRO to the MQD, oriented so that the MQD is NOT extending past the front of the objective lens as shown below.

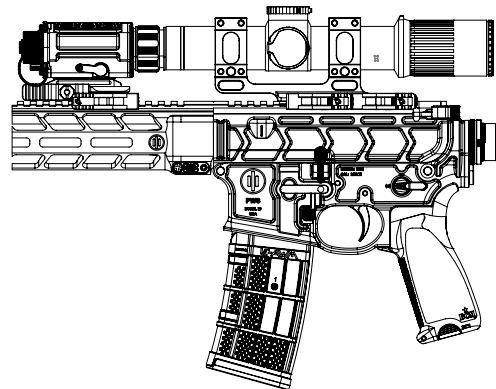

NOTE: We recommend going no higher than 6× on any riflescope used in clip-on mode as image performance will become unsatisfactory.

For a more detailed overview of this process, please visit irayusa.com/mqd.





13. SELECTING A WORKING MODE

RICO MICRO RL25

The RICO MICRO RL25 features three working modes: standalone, handheld, and helmet mode. The icon for the selected working mode appears on the left side of the status bar.

The RL25 is in handheld mode when powered on for the first time. After the first use, the last-used working mode is the default.

To switch between standalone and handheld mode:

1. From the main menu, Press Power , Menu , and Photo  simultaneously for 2 seconds to switch between modes. In standalone mode  the reticle is enabled and in handheld mode  the reticle is disabled.

To enter helmet mode:

1. Rotate the MICRO 180° (control buttons facing down) to automatically activate helmet mode.

RICO MICRO RH25





The RICO MICRO RH25 features four working modes: standalone, handheld, helmet, and clip-on. The icon for the selected working mode appears on the left side of the status bar.

The RH25 is in handheld mode when powered on for the first time. After the first use, the last-used working mode is the default.



HANDHELD MODE

Handheld mode allows the RH25 to be used as a handheld imager. Handheld mode is displayed at 1.3× and the reticle is disabled.

To enter handheld mode from clip-on or helmet mode:

1. From the home screen, long press **Menu**  to switch to handheld mode ; **OR**
2. From the main menu, select working mode  and then select handheld mode .





To enter handheld mode from standalone mode:

1. From the main menu, Press Power , Menu , and Photo  simultaneously for 2 seconds to switch to handheld mode (the reticle will be disabled).



STANDALONE MODE

In standalone mode, the RH25 can be used as a standalone weapon sight or it can be use as a handheld imager. Standalone mode is displayed at 1.3× and the reticle is displayed at all times.

To enter standalone mode from clip-on or helmet mode:

1. From the home screen, long press **Menu**  to switch to standalone mode ; **OR**
2. From the main menu, select working mode  and then select standalone mode .

To enter standalone mode from handheld mode:

1. From the main menu, Press Power , Menu , and Photo  simultaneously for 2 seconds to switch to standalone mode (the reticle will be enabled).

HELMET MODE

Helmet mode allows the RH25 display to be optimized for use on a helmet. In helmet mode, the screen size is reduced to 70% to be in unity (1×).





To enter helmet mode:

1. Rotate the MICRO 180° (control buttons facing down) to automatically activate helmet mode.

CLIP-ON MODE

In clip-on mode, the RH25 can be mounted in front of a riflescope.³ In clip-on mode, the screen size is reduced to 70% to be in unity (1×). The X/Y position of the screen may be adjusted so that the center of the screen matches up with the riflescope reticle. See **Adjusting Screen Position** on page 29.

To enter clip-on mode from standalone or handheld mode:

1. From the home screen, long press **Menu**  to switch to clip-on mode ; **OR**
2. From the main menu, select working mode  and then select clip-on mode .

To enter clip-on mode from helmet mode:

1. Rotate the MICRO 180° (control buttons facing down) to automatically deactivate helmet mode.
2. From the home screen, long press **Menu**  to switch to clip-on mode.

NOTE: An abbreviated menu appears in clip-on mode. See **Clip-on Mode Menu** on page 21.

3. We recommend going no higher than 6× on any riflescope used in clip-on mode as image performance will become unsatisfactory.

14. OPERATING INSTRUCTIONS

The Status Bar

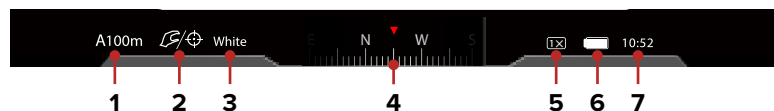

The status bar at the top of the screen displays operating status information for the MICRO:

- 1 Zero Profile & Distance:** Shows the selected zero profile: A, B, or C, and zero distance.
- 2 Working Mode:** Shows the selected mode: handheld, standalone, helmet, or clip-on. The last-used working mode is the default.
- 3 Imaging Mode:** Shows the current image mode: white hot, black hot, red hot, color. White hot is the default.
- 4 Digital Compass:** Displays when the compass is turned on. Compass is on by default.
- 5 Digital Zoom:** Shows the selected digital zoom magnification: 1x, 2x, 4x. 1x is the default.
- 6 Battery:** Five battery indicators show the current charge level. See the next section, **Battery Status**.
- 7 Clock:** Shows the current time.

NOTE: By default, the user interface is set to auto-hide after 15-seconds of no activity. Press any key to show the status bar. See **Auto-Hide** on page 49.

BATTERY STATUS

Five bars in the battery icon indicate the current battery status.

ICON	BARS / STATUS	BATTERY LEVEL
	5 Bars	80–100%
	4 Bars	60–79%
	3 Bars	40–59%
	2 Bars	20–39
	1 Bar	<20%
	Flashing Red	<5%, charge immediately

Navigating the Menu

From the home screen, short press **Menu** to enter the main menu.

In all menu interfaces:

- Short press **Photo** to move right.
- Short press **Power** to move left.
- A blue cursor indicates the current menu position.
- Short press **Menu** to select.
- Long press **Menu** to save any changes and return to the previous menu or screen.
- By default, after 15 seconds of inactivity, the menu closes and the interface returns to the home screen. See **Auto-Hide** on page 49.
- When exiting the menu, the cursor location is stored for a single working-session (i.e. until the MICRO is turned off). After restarting the MICRO, the cursor will return to the first menu item.



MAIN MENU

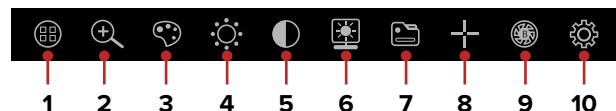

- 1 Working Mode⁴:** Change the working mode: handheld, standalone, helmet, or clip-on. The default is the last-used working mode.
- 2 Digital Zoom⁵:** Change the digital zoom magnification: 1x, 2x, 4x. The default is 1x.
- 3 Imaging Mode:** Change the imaging mode: white hot, black hot, red hot, color. The default is white hot.
- 4 Image Brightness:** Change image brightness: 0–9. The default is 5.
- 5 Contrast:** Change contrast: 0–9. The default is 5.
- 6 Screen Brightness:** Change screen brightness: 0–9. The default is 5.
- 7 File Management:** View or delete saved photos; play or delete saved videos; view current memory usage.
- 8 Reticle Menu⁶:** Open the reticle menu.
- 9 Background NUC⁶:** Perform a background NUC.
- 10 Advanced Settings Menu:** Open the advanced settings menu.

4. Only handheld and standalone are available on the RL25.

5. Digital zoom (2) is disabled in helmet and clip-on modes.

6. The reticle menu item (8) in the main menu is disabled and replaced by the background NUC menu item (9) in helmet, clip-on, and handheld modes.

RETICLE MENU⁷

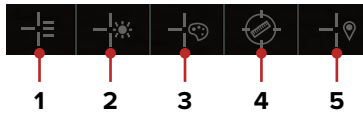

- 1 Reticle Style:** Change the reticle style: 1–7. The default is 2.
- 2 Reticle Brightness:** Change reticle brightness: 0–6. The default is 0 (completely transparent / not visible).
- 3 Reticle Color:** Change the reticle color: white, black, red, green. The default is white.
- 4 Zero Distance:** Change and/or customize the selected zero distance. The defaults are 100m, 200m, 300m.
- 5 Reticle Zero Setting:** Reposition the reticle for the selected zero distance. The default X/Y position is 0/0.

ADVANCED SETTINGS MENU

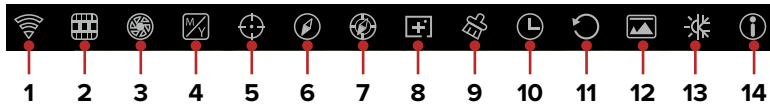

- 1 Wi-Fi On/Off:** Turn Wi-Fi on/off. The default is off.
- 2 Video Output:** Turn video output on/off. The default is off.
- 3 NUC Mode:** Change the non-uniformity correction (NUC) mode: automatic (**A**) or manual (**M**). The default is automatic.
- 4 Unit Selection⁸:** Change the units: meters (**m**) or yards (**y**). The default is meters.
- 5 Zero Profile⁹:** Change the zero profile: A, B, or C. The default is A.
- 6 Digital Compass On/Off⁹:** Turn the digital compass on/off. The default is on.
- 7 Compass Calibration:** Calibrate the compass.
- 8 Defective Pixel Correction:** Select and delete defective pixels.
- 9 Reformat Memory:** Erase the internal memory card.
- 10 Set Date/Time:** Set the current date and time.
- 11 Settings Reset:** Reset select user settings to factory defaults.
- 12 Auto-Hide:** Turn auto-hide on/off. The default is on.
- 13 Color Temperature:** Set the screen color temperature mode.
- 14 Device Info:** Shows device information.

7. The reticle submenu is disabled in helmet, clip-on, and handheld modes.

8. The unit selection (4) and zero profile (5) menu items are disabled in helmet, clip-on, and handheld modes.

9. The digital compass on/off menu item (6) is disabled in standalone and clip-on modes.

CLIP-ON MODE MENU

The clip-on mode menu is an abbreviated version of the standard menu.

Main Menu

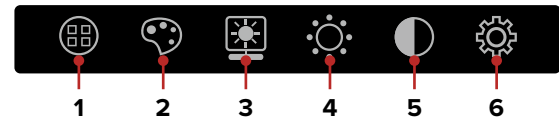

- 1 Working Mode:** Change the working mode: handheld, clip-on, helmet, or standalone. The default is the last-used working mode.
- 2 Imaging Mode:** Change the imaging mode: white hot, black hot, red hot, color. The default is white hot.
- 3 Screen Brightness:** Change screen brightness: 0–9. The default is 5.
- 4 Image Brightness:** Change image brightness: 0–9. The default is 5.
- 5 Contrast:** Change contrast: 0–9. The default is 5.
- 6 Advanced Settings Menu:** Open the advanced settings menu.

Advanced Settings Menu

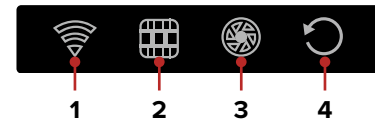

- 1 Wi-Fi On/Off:** Turn Wi-Fi on/off. The default is off.
- 2 Video Output:** Turn video output on/off. The default is off.
- 3 NUC Mode:** Change the non-uniformity correction (NUC) mode: automatic (**A**) or manual (**M**). The default is automatic.
- 4 Settings Reset:** Reset select user settings to factory defaults.

Manual and Automatic Shutdown

To maximize battery use-time, shutdown the MICRO when not in use.

To manually shut down the MICRO:

1. Long press **Power** (⏻) from the home screen.
2. A popup window will open.
3. Short press **Menu** (☰) to select ✓ to shut down the MICRO.

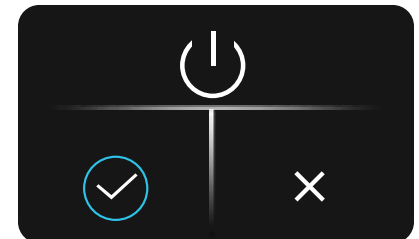



NOTES:

- The MICRO will automatically shut down if there is no operation for more than 40 minutes.
- After turning the MICRO off, wait at least 20 seconds before powering the device back on again.

Standby Mode

Standby mode may be activated to maximize battery use-time.

1. From the home screen, short press the **Power**  and **Menu**  simultaneously to activate standby mode.
2. Short press the buttons again to turn standby mode off.

Shortcut Button Combinations

The MICRO's three control buttons can be used to perform shortcut operations from the home screen and the main menu. See **Description of Control Buttons and Shortcuts** on page 6 for shortcut button combination details.

15. ZEROING THE MICRO

The RICO MICRO Series must be in standalone mode (reticle enabled) in order to begin zeroing. See **Selecting a Working Mode** on page 22.

To zero the MICRO:

1. First, confirm that the rifle is empty, safe, and pointed in a safe direction, with no ammunition near the weapon.
2. Set a suitable target at the desired zero distance.
3. Adjust the image, if necessary. See **Step 6: Adjust the Image-View** on page 9.
4. Select the zero profile: A, B, or C. The default is A. See **Zero Profile** on page 43.
5. Based on the distance to the target you wish to zero, select or customize one of the default zero distances to match. The MICRO supports custom zeroing distances of 1 to 999 meters or 1 to 999 yards. See **Zero Distance** on page 37.
6. Ensure a stable platform and natural shooting position is achieved behind the rifle.
7. Load ammunition, aim, shoot, and observe the location of impact on the target.
8. If the point of impact does not match the point of aim, move the X/Y position of the reticle until it matches the point of impact. See **Reticle Zero Setting** on page 38.
9. Take a confirmation shot—the point of impact should now match the point of aim. If not, repeat the process above.

16. NON-UNIFORMITY CORRECTION

A non-uniformity correction (NUC) allows a thermal imager's sensors to correct its pixels and eliminate any image defects caused by pixel drift.



The RICO MICRO Series has two NUC modes, automatic (**A**) and manual (**M**). See **NUC Mode** on page 42. In either mode, the user may also perform a background NUC.

Automatic Mode

The MICRO will perform a NUC automatically according to the internal software algorithm. There is no need to close the lens cover (**6**) as the MICRO's internal shutter covers the sensor. A manual NUC may be performed at any time while in Automatic (**A**) mode.



Manual Mode

The user independently determines the need to perform a NUC based on the quality of the observed image. It is not necessary to close the lens cover (**6**) during a manual NUC, as the internal shutter covers the sensor. To perform a manual NUC:

1. From the home screen, short press **Photo**  and **Menu**  simultaneously.
2. A manual NUC is performed instantly.

Background NUC

The user independently determines the need to perform a background NUC based on the quality of the observed image. A background NUC uses less power than an automatic or manual NUC because it does not use the imager shutter to cover the sensor; instead, the user must close the lens cover. A background NUC may be performed at any time, in either automatic (**A**) or manual (**M**) NUC mode. To perform a background NUC:

1. Close the lens cover (**6**).
2. From the home screen, long press **Photo**  and **Menu**  simultaneously.
3. A prompt to close the lens cover  appears onscreen. Background NUC starts after 2 seconds.

NOTE: If the lens is not properly covered, temporary “image burn” will remain in the image until the next calibration. This “image burn” is temporary and is not a defect or sign of permanent damage.



17. PHOTOGRAPHY AND VIDEO RECORDING

The MICRO is equipped with functionality for video recording and image capture. Images and videos are automatically saved on the MICRO's internal 64 GB memory storage.

Photo and video files are named with the time and date; therefore it is recommended to set the date and time before using the photo and video functions. See **Set Date/Time** on page 47. Date and time may instead be synchronized via the InfiRay Outdoor App. See **Using the Mobile App** on page 28.





Photography

To take a photo:

1. From the home screen, short press **Photo** .
2. The camera icon  appears on the left side of the screen.

Video Recording

To record video:

1. From the home screen, long press the **Photo**  to begin video recording.
2. The video icon  appears and a recording timer will be displayed, in the HH:MM:SS (hour: minute: second) format, on the left side of the screen.
3. Long press **Photo**  to stop and save the video recording.
4. When recording, short press **Photo**  to take a photograph.

Video and Photography Tips

- You may enter and use the menu as normal during video recording. User-interface data (the status bar, icons, and menu) are not captured in the recorded video and photo files.
- Recorded photos and videos are saved to the internal memory card of the MICRO in the format:
 - IMG_YYYYMMDDHHMMSS.jpg (photos).
 - VID_YYYYMMDDHHMMSS.mp4 (videos).
 - YYYYMMDDHHMMSS = year/month/day/hour/minute/second.
- Multimedia file names cannot be changed on the MICRO. However, any multimedia file may be copied to a computer and renamed there, if desired. See **Accessing Internal Memory** on the next page.
- Videos do not record audio. However, videos may be recorded with audio in the InfiRay Outdoor App using the mobile phone microphone.

CAUTION:

- The maximum duration of a recorded video file is 5 minutes. After this time, video recording will begin a new file automatically.
- The number of the recorded files is limited only by the capacity of the internal memory.
- Check the available space of the internal storage card regularly and move video footage and images to other storage media to free up space on the memory card. See **File Management** on page 33.

18. ACCESSING INTERNAL MEMORY

When the RICO MICRO Series is turned on and connected to a computer via the included video cable, it is recognized by the computer as a USB drive. This allows the user to access the saved multimedia files and copy or delete any desired files.

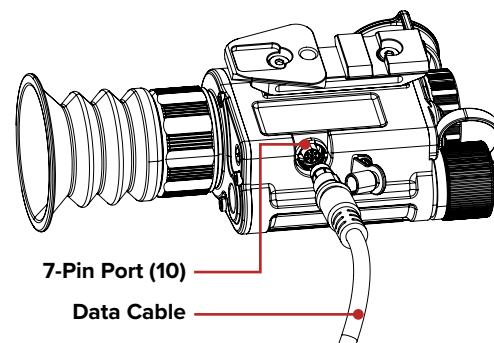

To access the internal memory:

1. Turn on the MICRO.
2. Connect the 7-pin data cable connector to the small round 7-pin port (10) on the side of the MICRO. Align the white dots on the connector and underside of the port.

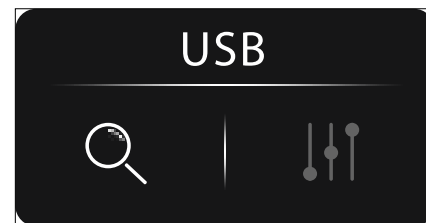

3. Plug the USB end of the cable into a USB port on the computer or laptop.
4. The MICRO will connect automatically to the computer. A popup window opens to indicate the MICRO is now being used as a USB drive.



NOTE: File access and photography and video recording functionality are disabled while the MICRO is connected to a computer. Three icons indicating this disabled functionality    appear on the left side of the screen.

To Access Files On Windows

1. Double-click the **This PC** icon on the desktop.
2. Double-click the unnamed USB drive in the Devices and Drives list to open it. The USB drive contains three folders:
 - a. PHOTO-CIF: Contains the photos stored on the MICRO.
 - b. VIDEO-CIF: Contains the videos stored on the MICRO.
 - c. .MISC: Ignore this folder; contains only thumbnail images.
3. Select desired files or folders to copy or delete.
4. When done, unplug the data cable by pulling firmly from the connector (not from the cable itself).





To Access Files On Mac

1. Double-click the untitled USB drive on the desktop. The USB drive contains a photo folder and a video folder.
2. Select desired files or folders to copy or delete.
3. When done, right-click the drive on your desktop and eject it.
4. Unplug the data cable by pulling firmly from the connector (not from the cable itself).

19. VIDEO OUTPUT

The video output function enables connectivity with an external display or recording device via analog video.

To output video:





1. Connect the 7-pin data cable connector to the small round 7-pin port **(10)** on the side of the MICRO. Align the white dots on the connector and port.
2. Plug the BNC data cable connector into a BNC port on the external display or recording/display device¹⁰.
3. From the home screen, short press **Menu**  to enter the main menu.
4. Select video output .
5. Turn video output on.
6. Long press **Menu**  to save the selection and return.
7. When video output is on, the video output icon  appears on the left side of the screen; the icon disappears when video output is off.

10. If recording via an RCA connector, an RCA adapter (not included) is required.

20. WI-FI CONNECTION

The MICRO has a function for wireless communication with a mobile device (smartphone or tablet) via Wi-Fi.

To enable the wireless module:

1. From the home screen, short press **Menu**  to enter the main menu.
2. Select Wi-Fi options .
3. Turn the Wi-Fi on.
4. Long press **Menu**  to save the selection and return.
5. When Wi-Fi is on, the Wi-Fi icon  displays on the left side of the screen; the icon disappears when Wi-Fi is off.
6. Scan a QR code to download the InfiRay Outdoor App from the App Store or Google Play.



NOTE: File access is disabled when Wi-Fi is on.

In the InfiRay Outdoor App:

7. Press the **ViewFinder** icon  at the bottom of the screen.
8. The ViewFinder screen will prompt the user to:
Open the mobile device > Go to device settings > Turn on device Wi-Fi > Connect to Wi-Fi.
9. Click the **Connect Device WiFi** button.

On the mobile device:

10. Go to **Settings > Wi-Fi**.
11. Select the MICRO from the list of Wi-Fi networks. The MICRO will appear in the list as "INFRARED_XXXX", where XXXX is four alphanumeric characters (numbers and letters).
12. Enter the Wi-Fi password. The default password is 123456789.

When Wi-Fi is successfully connected, the user may manipulate the MICRO via the InfiRay Outdoor App. See **Using the Mobile App** on page 28.

Firmware Upgrade



When a firmware update is available, it may be sent to the MICRO through Wi-Fi connection.

To check for and download an available firmware update:

1. On your mobile device, go to irayusa.com/fwpc.
2. If an update is available for the RICO MICRO Series, it will be listed at the top of the screen (look for your model number: RH25 or RL25).
3. Click the available update to download it.
4. Confirm you wish to download the file and select where to save the IMG file on your mobile device.



To upgrade the MICRO:

1. On the MICRO, turn on Wi-Fi to connect to the App. See **Wi-Fi Connection** on page 27.
2. Open the InfiRay Outdoor App.
3. In the App, press the **ViewFinder icon**  at the bottom of the screen.
4. Press the **Settings icon**  at top-right.
5. Press the **WiFi Firmware Upgrade button** at the bottom of the screen.
6. Press the **Choose Firmware button** to browse for the saved IMG file on your mobile device.
7. Press the **Start Upgrading button**. The app will display the current upload progress. The MICRO will automatically reboot when the upgrade has completed.



Using the InfiRay Outdoor Mobile App

When Wi-Fi is connected, users can manipulate the MICRO via the InfiRay Outdoor App, including:



- Change the Wi-Fi password.
- Synchronize time from the mobile device with the MICRO.
- Upgrade the firmware.
- Take photos and videos (with or without audio). Photos and videos taken via the app are saved to the mobile device.

Scan the QR code to download the InfiRay Outdoor App from the App Store or Google Play.

Wi-Fi Password Reset

The Wi-Fi password for the RICO MICRO Series can be reset in the InfiRay Outdoor App. The default password is: 123456789.

After connecting with a mobile device:

1. Open the InfiRay Outdoor App.
2. Press the **ViewFinder icon**  at the bottom of the screen.
3. Press the **Settings icon** .
4. In the password field, enter the new Wi-Fi password and click the **Submit button**. The password must be 8–16 numbers/letters.
5. The MICRO will automatically reboot to put the new password into effect.
6. On the mobile device, go to **Settings > Wi-Fi**, enter the new password, and press the **Join button**.





NOTE: When a settings reset is performed, the Wi-Fi password is reset to the default: 123456789. See **Settings Reset** on page 48.

21. DIGITAL ZOOM

The RICO MICRO RH25 can quickly increase the base magnification from 1× by enlarging the image from 1 to 4 times digitally.

The RL25 can increase the base magnification from 2× by enlarging the image from 2 to 8 times digitally.

To use digital zoom:



1. From the home screen, short press **Power**  to toggle through the three zoom options, 1×, 2×, and 4×.
2. The real-time amplification number appears in the status bar, for example .

NOTE: Digital zoom is disabled in helmet and clip-on modes.





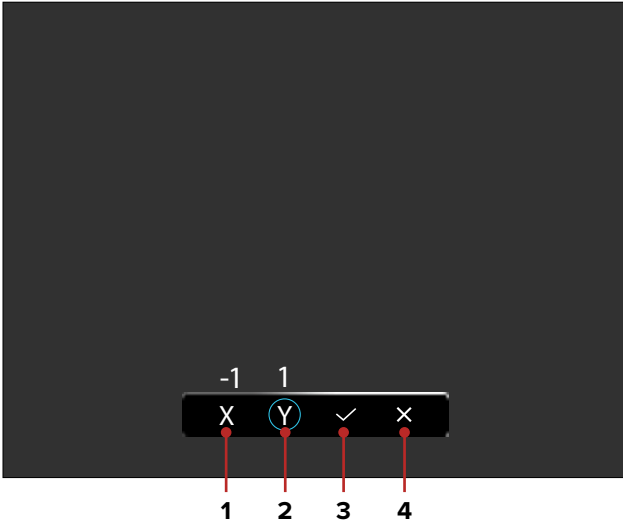

22. ADJUSTING SCREEN POSITION

In clip-on and helmet modes, the display size is reduced to 70% to be in unity (1×). The X/Y position of the screen may also be adjusted. On your first use, it may be necessary to adjust the X/Y of the screen to collimate the MICRO to your reticle. If your POI and POA differ in clip-on mode, adjust the screen as you would adjust the reticle in the zeroing section.

To adjust the screen position:

1. From the home screen, long press **Power**  and **Menu**  simultaneously to enter the screen-position adjustment interface.













2. The screen-position adjustment interface has the following features:
 - 1 **X**: Move screen along X-Axis.
 - 2 **Y**: Move screen along Y-Axis.
 - 3 **✓**: Save and return to menu.
 - 4 **✕**: Exit screen without saving.
3. To use the interface:
 - a. Short press **Photo**  or **Power**  to move through the interface. The cursor position is indicated by a white outline around the button.
 - b. Short press **Menu**  to select a button. The selection is indicated by a blue outline around the button.
 - c. Long press **Menu**  to deselect the button.
4. Adjust the X/Y position of the screen.
 - a. Use **Photo**  to move in the positive X (right) and Y (up) direction.
 - b. Use **Power**  to move in the negative X (left) and Y (down) direction.
 - c. Short press to move the reticle in the corresponding direction by 1 pixel; long press to move 10 pixels.
5. Select **✓** to save the screen position and return to the home screen; **OR**
6. Select **✕** to exit without saving and return to the home screen.

23. MENU OPTIONS & DESCRIPTIONS

Menu option descriptions and navigation instructions are listed in order on the following pages.





Working Mode

Change the working mode

1. Short press **Menu**  to enter the main menu.
2. Short press **Photo**  or **Power**  to move through the menu.
3. Short press **Menu**  to select the working mode .
4. Short press **Photo**  or **Power**  to move through the working mode options, clip-on  and standalone . The default is the last-used working mode.
5. Long press **Menu**  to save the selection and return.
6. The set working mode appears on the left side of the status bar.











NOTES:

- The RL25 has standalone  and handheld  mode only.
- To enter helmet  mode, rotate the MICRO 180° (buttons facing down).
- When the reticle is disabled, handheld  mode appears instead of standalone mode  in the working mode options.

Digital Zoom

Adjust the digital zoom

1. Short press **Menu**  to enter the main menu.
2. Short press **Photo**  or **Power**  to move through the menu.
3. Short press **Menu**  to select digital zoom .
4. Short press **Photo**  or **Power**  to move through the digital zoom options, 1x, 2x, and 4x. The default is 1x.
5. Long press **Menu**  to save the selection and return.
6. The real-time amplification number, , appears on the right side of the status bar.



Imaging Mode 🗨️

Change the imaging mode

1. Short press **Menu** [☰] to enter the main menu.
2. Short press **Photo** [📷] or **Power** [🔋] to move through the menu.
3. Short press **Menu** [☰] to select imaging mode 🗨️.
4. Short press **Photo** [📷] or **Power** [🔋] to move through the imaging mode options, white hot, black hot, red hot, and color. The default is white hot.
5. Long press **Menu** [☰] to save the selection and return.
6. The selected imaging mode appears on the left side of the status bar.



Image Brightness ☀️

Adjust the image brightness

1. Short press **Menu** [☰] to enter the main menu.
2. Short press **Photo** [📷] or **Power** [🔋] to move through the menu.
3. Short press **Menu** [☰] to select image brightness ☀️.
4. Short press **Photo** [📷] or **Power** [🔋] to move through the image brightness options, 0–9. The default is 5.
5. Long press **Menu** [☰] to save the selection and return.



Contrast 🌑

Adjust the contrast

1. Short press **Menu** [☰] to enter the main menu.
2. Short press **Photo** [📷] or **Power** [🔋] to move through the menu.
3. Short press **Menu** [☰] to select the contrast 🌑.
4. Short press **Photo** [📷] or **Power** [🔋] to move through the contrast options, 0–9. The default is 5.
5. Long press **Menu** [☰] to save the selection and return.



Screen Brightness 🌞

Adjust the screen brightness

1. Short press **Menu** [☰] to enter the main menu.
2. Short press **Photo** [📷] or **Power** [🔋] to move through the menu.
3. Short press **Menu** [☰] to select screen brightness 🌞.
4. Short press **Photo** [📷] or **Power** [🔋] to move through the screen brightness options, 0–9. The default is 5.
5. Long press **Menu** [☰] to save the selection and return.



File Management 📁

Manage files

NOTE: File access is disabled when Wi-Fi is on Wi-Fi is on or when connected via USB.

1. Short press **Menu** [☰] to enter the main menu.
2. Short press **Photo** [📷] or **Power** [🔋] to move through the menu.
3. Short press **Menu** [☰] to select file management 📁 and open the file management interface.





4. The file management screen has the following features:

- 1 Memory:** Shows unused memory / total memory.
 - 2 Operations Menu:**
 - a. : View/manage photos.
 - b. : Play/manage videos.
 - c. : Return to main menu.
 - 3 File List:** Shows the list of photos or videos on the MICRO. The selected photo or video is highlighted.
 - 4 Thumbnail Window:** Shows a thumbnail of the selected photo or video.
 - 5 File Management Menu:**
 - a. : View the selected image.
 - b. : Go to the previous page of photos/videos.
 - c. : Go to the next page of photos/videos.
 - d. : Delete the selected image.
 - e. Page Count: Shows current / total pages.
5. Short press **Photo** or **Power** to move through the operations menu options: to select photo or video to manage files.
 6. Short press **Menu** to make the selection.
 7. Short press **Photo** or **Power** to move up and down through the file list.
 8. Short press **Menu** to select a file. The selected photo or video will appear in the thumbnail window.
 9. Short press **Photo** or **Power** to move through the file management options.

10. Short press **Menu** to select a file management option:

- a. Select to view/play the selected file full-screen.
- b. Select to view the next page.
- c. Select to the previous page.
- d. Select to delete the file.

11. When finished managing files, long press **Menu** to return to previous until the operations menu is reached.

12. Short press **Photo** or **Power** to move through the operations menu options.

13. Short press **Menu** to select to exit the screen.

Reticle Menu

Change the reticle settings

1. Short press **Menu** to enter the main menu.
2. Short press **Photo** or **Power** to move through the menu.
3. Short press **Menu** to select reticle menu .
4. There are five submenu items: reticle style, reticle brightness, reticle color, zero distance, and reticle zero setting.



NOTE: The reticle menu is enabled in standalone mode only. In handheld and helmet modes, the reticle menu item is replaced by the Background NUC menu item.

RETICLE MENU > RETICLE STYLE

Change the reticle style

1. In the reticle menu, short press **Photo** or **Power** to move through the menu.
2. Short press **Menu** to select reticle style .
3. Short press **Photo** or **Power** to move through the style options, 1–7, see next page. The default is 2.
4. Long press **Menu** to save the selection and return.





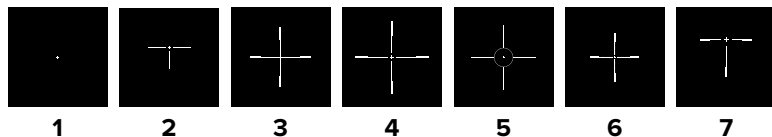



Reticle Styles



NOTE: If the reticle is not visible, adjust the default reticle brightness of 0 to see it. See next section, Reticle Brightness.

RETICLE MENU > RETICLE BRIGHTNESS







Adjust the reticle brightness

1. In the reticle menu, short press **Photo**  or **Power**  to move through the menu.
2. Short press **Menu**  to select reticle brightness .
3. Short press **Photo**  or **Power**  to move through the brightness options, 0–6. The default is 0 (completely transparent / not visible).
4. Long press **Menu**  to save the selection and return.



RETICLE MENU > RETICLE COLOR

Change the reticle color

1. In the reticle menu, short press **Photo**  or **Power**  to move through the menu.
2. Short press **Menu**  to select the reticle color .
3. Short press **Photo**  or **Power**  to move through the color options, white, black, red, and green. The default is white.
4. Long press **Menu**  to save the selection and return.









RETICLE MENU > ZERO DISTANCE



Select or customize a zero distance

There are nine customizable zero distances, three in each zero profile, A, B, and C. See **Zero Profile** on page 43. Each zero distance may be customized per the instructions below and a custom reticle position may be set. See **Reticle Zero Setting** on page 38. The MICRO supports zeroing distances of 1 to 999 meters or yards.







1. Choose the desired zero profile, A, B, or C. See **Zero Profile** on page 43.
2. Short press **Photo**  or **Power**  to move through the menu.
3. Short press **Menu**  to select zero distance .
4. Short press **Photo**  or **Power**  to move through the factory-default distance options, 100m, 200m, 300m. The default is 100m.

To select a zero distance:

5. Long press **Menu**  to save the selection and return to the reticle menu if you wish to use a default zero distance; **OR**
6. Short press **Menu**  to customize the selected zero distance.

To customize the selected zero distance:





7. Short press **Photo**  or **Power**  to increase and decrease the selected digit, from 0–9. A blue arrow appears above the digit being set.
8. Short press **Menu**  to save changes and move to the next digit.
9. Long press **Menu**  to save the custom zero distance.
10. Repeat the steps above to select and customize all three default zero distances, if desired.
11. Long press **Menu**  to save all changes and return.
12. The selected zero profile and zero distance appear on the left side of the status bar.

RETICLE MENU > RETICLE ZERO SETTING

Adjust the reticle position

A custom reticle zero may be set for each zero distance.



1. Choose the desired zero profile, A, B, or C. See **Zero Profile** on page 43.
2. Select the desired zero distance, 100m, 200m, or 300m, and adjust it, if desired. See **Zero Distance** on page 37.
3. In the reticle menu, short press **Photo**  or **Power**  to move through the menu.
4. Short press **Menu**  to select reticle zero setting  and enter the interface.

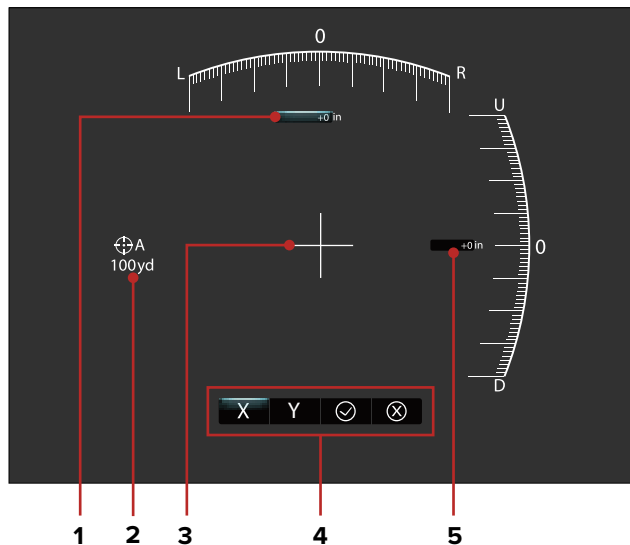







5. The reticle adjustment screen has the following features:
 - 1 **X-Axis Change:** Horizontal point of impact change (in cm or in).
 - 2 **A100yd:** Selected zero profile and distance.
 - 3 **Cursor:** Current reticle position.

4 Interface Buttons:

- a. **X:** Move reticle along X-Axis.
- b. **Y:** Move reticle along Y-Axis.
- c. **✓:** Save and return to menu.
- d. **✕:** Exit screen without saving.







5 Y-Axis Change: Vertical point of impact change (in cm or in).

6. To use the interface:
 - a. Short press **Photo**  or **Power**  to move through the interface. The cursor position is indicated by a blue line at the top of the button.
 - b. Short press **Menu**  to select an interface button. The selected button will highlight blue.
 - c. Long press **Menu**  to deselect the button.
7. Adjust the X/Y position of the reticle according to the zeroing target. See **Zeroing the MICRO** on page 22.
 - a. The X-Axis (horizontal) is the windage and the Y-Axis (vertical) is the elevation.
 - b. Use **Photo**  to move in the positive X (right) and Y (up) direction.
 - c. Use **Power**  to move in the negative X (left) and Y (down) direction.
 - d. Short press to move the reticle in the corresponding direction by 1 pixel; long press to move 10 pixels.
 - e. When adjusting your zero at a distance of 50 yards, moving 1 “click” will change the impact point by 0.58”, as shown in the X and Y coordinate displays. At 100 yards that same “click” is 1.15”, and 2.3” at 200 yards.
 - f. Changing your zero distance will change the distance of your X/Y adjustments automatically. If your selected zero distance has a correction of 1.15” at 100 yards, it will automatically change to 2.3” if you change the zero distance to 200 yards.
8. Select **✓** to save the reticle position and return; **OR**
9. Select **✕** to exit the screen without saving and return.

Background NUC

In helmet and handheld modes, the reticle is disabled and the reticle menu item is replaced by the Background NUC (non-uniformity correction) menu item. See **Non-uniformity Correction (NUC)** on page 23.







1. Short press **Menu**  to enter the main menu.
2. Short press **Photo**  or **Power**  to move through the menu.
3. Close the lens cover (6).
4. Short press **Menu**  to select background NUC .
5. A prompt to close the lens cover  appears onscreen. A background NUC is performed after 2 seconds and the MICRO will automatically return to the main menu.

NOTE: If the lens is not properly covered, temporary “image burn” will remain in the image until the next calibration. This “image burn” is temporary and is not a defect or sign of permanent damage.

Advanced Settings

Change the advanced settings







1. Short press **Menu**  to enter the main menu.
2. Short press **Photo**  or **Power**  to move through the menu.
3. Short press **Menu**  to select advanced settings menu .
4. There are thirteen submenu items: Wi-Fi options, video output, NUC mode, unit selection, zero profile, digital compass on/off, compass calibration, defective pixel correction, reformat memory, set date/time, settings reset, auto-hide, and device info.



ADVANCED SETTINGS MENU > WI-FI OPTIONS

Turn Wi-Fi on/off

Turn Wi-Fi on to manipulate the MICRO via the InfiRay Outdoor App. See **Wi-Fi Connection** on page 27.

1. In advanced settings, short press **Photo**  or **Power**  to move through the menu.
2. Short press **Menu**  to select Wi-Fi options .
3. Short press **Photo**  or **Power**  to move through the Wi-Fi options, on and off. The default is off.
4. Long press **Menu**  to save the selection and return.







NOTE: When Wi-Fi is on, the Wi-Fi icon  displays on the left side of the screen; the icon disappears when Wi-Fi is off.



ADVANCED SETTINGS MENU > VIDEO OUTPUT OPTIONS

Turn video output on/off

The video output function enables connectivity with an external display or recording device via analog video. See **Video Output** on page 26.







1. In advanced settings, short press **Photo**  or **Power**  to move through the menu.
2. Short press **Menu**  to select video output .
3. Short press **Photo**  or **Power**  to move through the video output options, on and off. The default is off.
4. Long press **Menu**  to save the selection and return.

NOTE: When video output is on, the video output icon  appears on the left side of the screen; the icon disappears when video output is off.



ADVANCED SETTINGS MENU > NUC MODE

Set non-uniformity correction (NUC) mode







1. In advanced settings, short press **Photo**  or **Power**  to move through the menu.
2. Short press **Menu**  to select non-uniformity correction (NUC) mode .
3. Short press **Photo**  or **Power**  to move through the NUC mode options, automatic (A) and manual (M). The default is automatic (A).
4. Long press **Menu**  to save the selection and return.





NOTE: See **Non-uniformity Correction (NUC)** on page 23.



ADVANCED SETTINGS MENU > UNIT SELECTION

Set the units of measure

1. In advanced settings, short press **Photo**  or **Power**  to move through the menu.
2. Short press **Menu**  to select units .
3. Short press **Photo**  or **Power**  to move through the unit options, meters (m) and yards (y). The default is meters (m).
4. Long press **Menu**  to save the selection and return.







NOTE: The unit selection menu item is only enabled in standalone  mode. It is disabled in clip-on , helmet , and handheld  mode because the reticle is disabled.







ADVANCED SETTINGS MENU > ZERO PROFILE

Select zero profile

There are three zero profiles: A, B, and C. Each has three customizable zero distances. See **Zero Distance** on page 37 and **Reticle Zero Setting** on page 38 for instructions on customizing the nine zero distances.







1. In advanced settings, short press **Photo**  or **Power**  to move through the menu.
2. Short press **Menu**  to select the zero profile .
3. Short press **Photo**  or **Power**  to move through the three zero profile options, A, B, and C. The default is A.
4. Long press **Menu**  to save the selection and return.
5. The selected zero profile appears on the left side of the status bar.

NOTE: The zero profile menu item is only enabled in standalone  mode. It is disabled in clip-on , helmet , and handheld  mode because the reticle is disabled.



ADVANCED SETTINGS MENU > DIGITAL COMPASS

Turn the digital compass on/off

1. In advanced settings, short press **Photo**  or **Power**  to move through the menu.
1. Short press **Menu**  to select digital compass on/off .
2. Short press **Photo**  or **Power**  to move through the options, on and off. The default is on.
3. Long press **Menu**  to save the selection and return.
4. When the digital compass function is turned off, the digital compass in the status bar and in the right sidebar are hidden.

NOTE: This digital compass menu item is only enabled in the advanced settings menu in helmet and handheld modes.







ADVANCED SETTINGS MENU > COMPASS

CALIBRATION

Calibrate the digital compass

When the user location changes, or the magnetic field changes dramatically, re-calibration may be necessary to ensure the accuracy of the digital compass.







1. In advanced settings, short press **Photo**  or **Power**  to move through the menu.
2. Short press **Menu**  to select compass calibration .
3. A triaxial coordinate prompt will appear on the screen.
4. Follow the prompt to rotate the MICRO at least 360 degrees along the X, Y, and Z axes. Rotations must be completed within the 30-second calibration time.
5. After 30 seconds, the calibration will conclude automatically and MICRO will automatically return to the advanced settings menu.

ADVANCED SETTINGS MENU > DEFECTIVE PIXEL CORRECTION





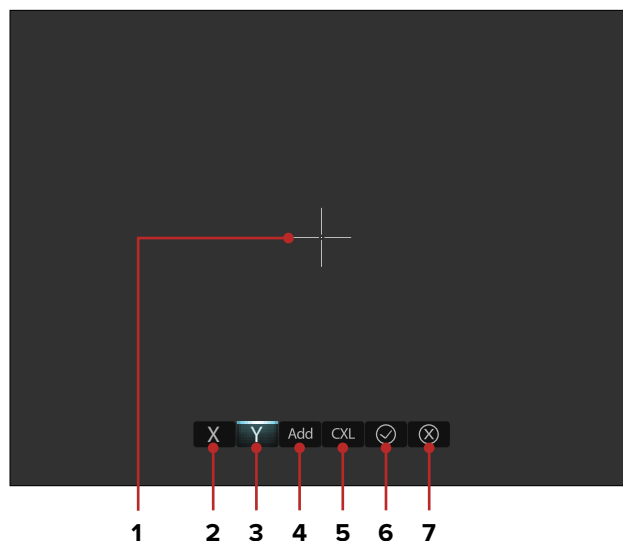

Correct Defective pixels

Defect pixels are pixels that do not change correctly compared to the other image pixels—they are either brighter or darker than surrounding pixels. The RICO MICRO Series has a tool for correcting any defective pixels on the sensor using its internal software. In addition, any previous pixel corrections may be cleared.



1. In advanced settings, short press **Photo**  or **Power**  to move through the menu.
2. Short press **Menu**  to select pixel correction  and enter the defective pixel correction interface.
3. A small cross cursor will appear, replacing the reticle in the center of the screen.



4. The defective pixel correction screen has the following features:
 - 1 **Cursor:** Pixel position.
 - 2 **X:** Move cursor along X-Axis.
 - 3 **Y:** Move cursor along Y-Axis.
 - 4 **Add:** Add a defective pixel marker.
 - 5 **CXL:** Clear previously saved pixel corrections.
 - 6 **✓:** Save and exit.
 - 7 **✕:** Exit screen without saving.
5. To use the interface:
 - a. Short press **Photo**  or **Power**  to move through the interface. The cursor position is indicated by a blue line at the top of the button.
 - b. Short press **Menu**  to select an interface button. The selected button will highlight blue.
 - c. Long press **Menu**  to deselect the button.
6. Select the **CXL** button to clear any previously saved pixel corrections, if desired.
7. Select the **X** and **Y** to move the cursor to the location of the defective pixel.
 - a. Use **Photo**  to move in the positive X (right) and Y (up) direction.
 - b. Use **Power**  to move in the negative X (left) and Y (down) direction.
 - c. Short press to move the reticle in the corresponding direction by 1 pixel; long press to move 10 pixels.

8. Select **Add** to confirm the location of a defective pixel and add it to a 'to be deleted list'. The button will briefly highlight blue to indicate the pixel has been added.
9. Repeat steps 6–7 to add any additional defective pixels.
10. Select **✓** to perform pixel correction for all saved pixels and return to the advanced settings menu; **OR**
11. Select **x** to exit the screen without performing pixel corrections and return to the advanced settings menu.







ADVANCED SETTINGS MENU > REFORMAT MEMORY

Reformat the internal memory card

This function quickly erases all files saved to the internal memory card.

WARNING: Before reformatting make sure to back up any photos and videos you want to keep. All files saved on the internal memory card will be permanently deleted.







1. In advanced settings, short press **Photo**  or **Power**  to move through the menu.
2. Short press **Menu**  to select reformat memory .
3. A confirmation pop-up window will open showing two buttons: **✓** and **x**. Cancel **x** is selected by default.
4. Short press **Menu**  to select **x** to cancel and return to advanced settings; **OR**
5. Short press **Power** , then short press **Menu**  to select **✓** and begin reformatting.
6. A loading icon will appear onscreen for about 20 seconds as the memory is reformatted. The screen returns to the advanced settings menu automatically.

NOTE: Do not perform any other operations during reformatting.

ADVANCED SETTINGS MENU > SET DATE/TIME

Set the date and time

1. In advanced settings, short press **Photo**  or **Power**  to move through the menu.
2. Short press **Menu**  to select set date/time .
3. The date/time popup opens.
4. The set date/time popup has the following features:





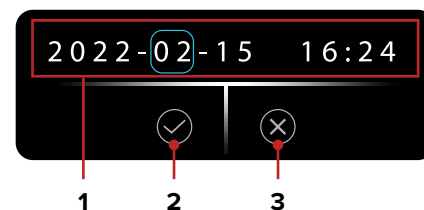

1 Date/Time Fields:

- a. **YYYY-MM-DD:**
Year-Month-Day
- b. **HH:MM:**
Hour:Minute



2 **✓**: Save and exit.

3 **x**: Exit screen without saving.











5. To use the popup interface:
 - a. Short press **Photo**  or **Power**  to move through the interface. The cursor position is indicated by a blue outline around the field or button.
 - b. Short press **Menu**  to select an interface field or button. Selected fields will highlight blue.
 - c. Long press **Menu**  to save the changes and deselect the field
6. Set the year, month, day, hours, minutes.
7. Select **✓** to save the new date and time and return to the advanced settings menu; **OR**
8. Select **x** to exit the popup without saving and return to the advanced settings menu.

NOTE: Alternately, the date/time may be synchronized with a mobile device using the InfiRay Outdoor App. See **Using the Mobile App** on page 29.

NOTE: The time displays on the right side of the status bar.

ADVANCED SETTINGS MENU > SETTINGS RESET

Perform a partial user settings reset

1. In advanced settings, short press **Photo**  or **Power**  to move through the menu
2. Short press **Menu**  to select settings reset .
3. A confirmation pop-up window will open showing two buttons:  and . Cancel is selected by default.
4. Short press **Menu**  to select  to cancel and return to advanced settings; **OR**
5. Short press **Power** , then short press **Menu**  to select  and begin the settings reset.

NOTES:

- Settings reset cannot be undone.
- The user settings listed below will be reset to the factory defaults:
 - Imaging Mode: White hot
 - Image Brightness: 5
 - Contrast: 5
 - Screen Brightness: 5
 - Digital Zoom: 1x
 - Wi-Fi: Off
 - Video Output: Off
 - Digital Compass: On
 - Wi-Fi password: 123456789.
- All other user settings do not reset, including date/time, user reticle settings (style, color, and brightness), zero distance and reticle zero settings, and the selected zero profile.



ADVANCED SETTINGS MENU > AUTO-HIDE







Turn auto-hide on/off

This function enables automatic hiding of all interface information, aside from the reticle, for unobstructed image-view.

When auto-hide is on, the status bar, digital compass, and all interface icons will be automatically hidden after 15 seconds of no operation, leaving only the image and the reticle displayed.

When the menu is open, the menu will hide after 15 seconds of no operation and the rest of the MICRO interface will hide after an additional 15 seconds.

Press any button to show all interface information. Shortcut button combinations and the menu are disabled until the entire interface is again displayed.







1. In advanced settings, short press **Photo**  or **Power**  to move through the menu.
2. Short press **Menu**  to select auto-hide .
3. Short press **Photo**  or **Power**  to move through the auto-hide options, on and off. The default is off.
4. Long press **Menu**  to save the selection and return.



ADVANCED SETTINGS MENU > COLOR

TEMPERATURE

Select the screen color temperature mode

1. In advanced settings, short press **Photo**  or **Power**  to move through the menu.
1. Short press **Menu**  to select color temperature .
2. Short press **Photo**  or **Power**  to move through the color temperature options, warm and cold. The default is cold.
3. Long press **Menu**  to close the pop-up and return.







ADVANCED SETTINGS MENU > DEVICE INFO ⓘ

Show device information

This menu item allows the user to view the following device information: model, PN, and SN number of the MICRO, the FPGA number, and hardware version.



1. In advanced settings, short press **Photo**  or **Power**  to move through the menu.
2. Short press **Menu**  to select device info ⓘ. A pop-up window will display device information.
3. Long press **Menu**  to close the pop-up and return.

24. WARRANTY

At iRayUSA we're first and foremost hunters and users of our products and we understand that failure isn't an option. We also understand that having to wait extended periods for repair isn't something that a customer should have to put up with when something does go wrong. During your published warranty period, iRayUSA will repair or replace, at its discretion, any optic that becomes defective during normal use. Additionally, if we cannot fix your optic in less than one week, we will offer to replace it with a replacement product in like or better condition. If you would rather wait for your specific optic to be repaired, we can handle that too.

We know you've never seen this from a thermal manufacturer, neither have we, and that's why we started iRayUSA.

Our warranty follows the product, and is not tied to the original owner. The warranty period is tied to the date of sale to the dealer. This warranty only covers normal use and does not cover cosmetic damage, normal wear, intentional damage, theft, loss, any act of God, or a condition caused by use other than intended. Any product that is modified, opened, or tampered with will void any warranty coverage. Any serial number damage or alteration on the product will be considered modification.

To return a product for repair:

1. Go to irayusa.com/warranty and click the **Request an RMA button** to request an RMA number. Returns will not be accepted without an RMA.
2. The customer is responsible for shipping the product to iRayUSA, to the address below. iRayUSA will return the product at no cost.

iRayUSA
800 Railhead Road #316
Fort Worth, TX 76106

- The one-week timeline starts from the time of receipt of product at iRayUSA.
- iRayUSA is not liable for any damages or loss incurred when shipping to iRayUSA.
- This warranty gives you specific legal rights, and you may also have other rights which vary from state to state.

Please give us a call at **800-769-7125**, visit irayusa.com/warranty, or email info@InfiRayUSA.com with any questions.

25. BASIC INSPECTION

It is recommended to carry out a technical inspection before each use. Please check the following:

- The MICRO's appearance: there should be no cracks in the body, or visible damage.
- The condition of the objective lens and eyepiece: there should be no cracks, greasy spots, dirt or other deposits on the lenses.
- The rechargeable battery should be fully charged.
- The control buttons should be in working order.

26. BASIC CARE AND MAINTENANCE

Always replace the lens cover after use to avoid damaging or scratching the lens. Never touch the lens directly; oil from your skin can damage the lens coating and surface.

Basic maintenance should be carried out at least twice a year and includes the following steps:

- Wipe the surface of external metal and plastic components with a clean, dry cotton cloth. Do not use chemical, corrosive, or abrasive cleaners. Canned air may also be used to clean the external components.
- Clean the electric contacts and battery slots on the MICRO using a non-greasy organic solvent.
- Only clean the lens when it is visibly soiled. Frequent wiping or cleaning can degrade the anti-reflective lens coating.
- Check the lens and eyepiece. If necessary, remove any dirt and sand from the optics—a non-contact cleaning method is preferred. Cleaning the exterior of the lens should only be done with the included microfiber lens cloth or similar product.

Additional Care Considerations

- Install battery and calibrate at least once every six months.
- Do not attempt to disassemble or repair the MICRO. Doing so will void the warranty.
- The MICRO's electrical and optical components are susceptible to static electricity. Do not expose to electrostatic discharge.
- Do not throw, drop, shake, or crush the MICRO.

27. GENERAL TROUBLESHOOTING

The troubleshooting table below lists issues that may occur when operating the RICO MICRO Series. Carry out the recommended troubleshooting steps in the order shown in the table. Please contact iRayUSA or an authorized vendor for assistance before attempting to perform any modifications or repairs beyond the scope of the troubleshooting procedures in this manual. Unauthorized repairs or modifications will void your warranty.

ISSUE	POSSIBLE CAUSES
The MICRO will not turn on.	Battery is low or completely discharged.
The MICRO cannot connect to the computer	Video cable is not properly connected.
	Video cable is damaged.
The MICRO cannot connect to mobile device (smartphone or tablet).	Wi-Fi is not turned on.
	Wi-Fi password is not entered correctly.
	Too many Wi-Fi signals around the device.
Wi-Fi signal has been lost or interrupted.	Smartphone or tablet is out of range of a strong Wi-Fi signal, or there are obstacles between the device and the smartphone.
The image is fuzzy, not clear, not balanced, has artifacts.	Non-uniformity correction (NUC) is required.
The image is too dark	Brightness level is too low.
The GUI is clear, but the image is fuzzy.	The lens is not focused.
	There is dust on the interior or exterior optical surfaces of the lens.
	There is condensation on the interior or exterior optical surfaces of the lens.
The reticle shifts after firing rounds.	The MICRO is not mounted securely or the mount is not secured on the MICRO.
The image of the object being observed is missing.	Looking through glass.
The MICRO will not focus.	Image settings are not optimal for environmental conditions or object being observed.
	Exterior contaminants on the lens.
Image quality is too low or the detection range is reduced.	Environmental conditions.
When the MICRO is used in low temperature conditions, the image quality of the surroundings is worse than in warm temperature conditions.	Environmental conditions.

SUPPORT / SERVICE:

irayusa.com/support

info@irayusa.com

800-769-7125

TROUBLESHOOTING STEPS
Charge the battery.
Check the cable to make sure it is properly inserted into the 7-pin port on the side of the MICRO. Ensure the white dot on the cable connector aligns with the white dot on the port.
Replace video cable.
On the MICRO, go to Advanced Settings > Wi-Fi Options to turn on Wi-Fi. See Wi-Fi Connection on page 27.
Enter correct password. The default password is 123456789. On the mobile device, go to Settings > Wi-Fi and re-enter the Wi-Fi password. See Wi-Fi Connection on page 27.
Move the device to an area with no or fewer Wi-Fi signals.
Relocate the device until Wi-Fi signal is stable.
Perform a non-uniformity correction. See Non-uniformity Correction on page 23.
Adjust screen brightness in the main menu.
Adjust the image sharpness by rotating the objective lens focus ring.
Wipe off the outside optical surfaces with the included lens cloth.
Let the MICRO dry by leaving it in a warm environment for at least 4 hours.
<ul style="list-style-type: none"> • Check that the MICRO has been securely mounted. • Make sure you are using the same brand, type, and weight of the bullets as when the MICRO and weapon were initially zeroed. • If the MICRO was zeroed in different environmental conditions, a slight zero shift is possible.
Remove any glass windows from the field of view.
1. Adjust the MICRO objective focus ring and the image settings according to the Quick Start Guide on page 8.
<ol style="list-style-type: none"> 1. Check the outer surfaces of the objective lenses and eyepiece and, where necessary, wipe away any dust, condensation, frost, etc. 2. In cold weather, you can use special anti-fogging coatings, such as those made for corrective glasses.
These issues may occur due to the weather conditions, such as snow, rain, humidity, fog, etc.
In warm temperature conditions, objects being observed (surroundings and background) heat up differently because of thermal conductivity, thereby generating a high temperature contrast. Accordingly, image quality produced by the thermal imager will be higher. In low temperature conditions, the background will cool down to roughly the same temperature, and thus the temperature contrast is substantially reduced and image detail can go down as there is less contrast in the scene. This is a normal function of a thermal imager and is no indicator of actual detector performance.



800 Railhead Road #316
Fort Worth TX 76106
800-769-7125
682-499-0047
info@irayusa.com