

Hobbe.

ASSEMBLY INSTRUCTIONS GEORGETOWN

IMPORTANT: READ THESE INSTRUCTIONS CAREFULLY BEFORE ATTEMPTING TO ASSEMBLE OR USE YOUR CHAIR.

PLEASE KEEP THESE INSTRUCTIONS FOR FUTURE REFERENCE.

HEALTH & SAFETY:

DO NOT jump on this chair.

DO NOT use this chair if any parts are missing, damaged or worn.

DO NOT use this chair unless all fixings are tightly secured.

Always use on a level and even surface.

Proper assembly is crucial.

Improper assembly can result in damage to your chair or cause injuries.

Ensure an adult is always present during use of the chair.

CARE & MAINTENANCE:

Periodically check all screws & fixings to ensure they are tightly secured.

Always lift the chair with two people whenever you need to change the chair position.

Keep any sharp objects away from the chair.

To avoid possible scratching, assemble furniture on a soft surface such as carpet or a blanket.



NECESSARY TOOLS



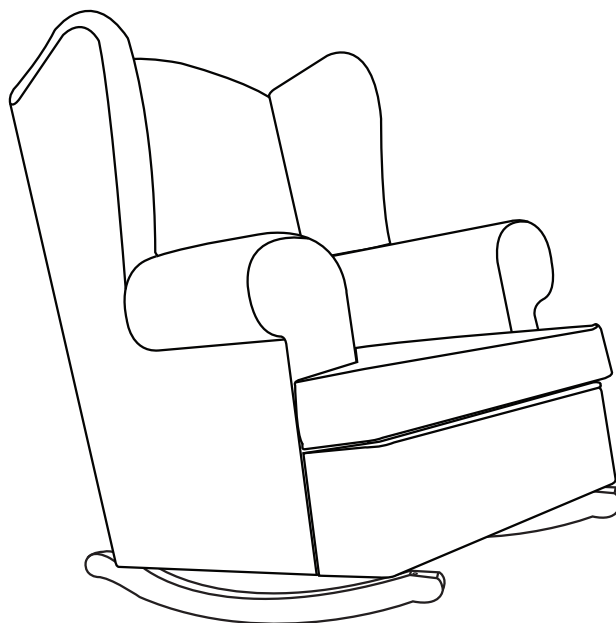

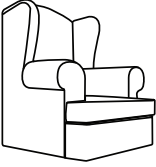

This tool can be used on both ends



PART LIST

<p>A.</p>  <p>Rocker Chair x 1</p>	<p>B.</p>  <p>Wooden Legs x 2</p>
---	--

HARDWARE

<p>1.</p>  <p>M6 x 80mm x 4pcs</p>	<p>2.</p>  <p>Washer M8 x 4pcs</p>	<p>3.</p>  <p>Spring Washer M6 x 4pcs</p>	<p>4.</p>  <p>Allen Key M4 x 1</p>
---	--	--	---

1.

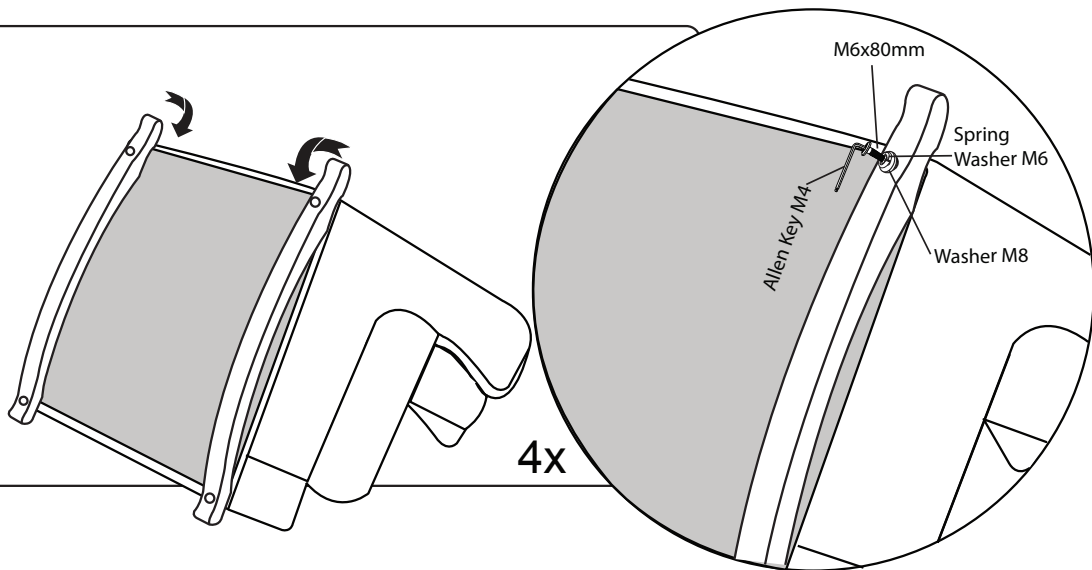

2.

