



OFFICINA
NICOLAZZI
DAL 1960



BATHTUB SET WITH SHOWER

Art: Z1401

Specifications

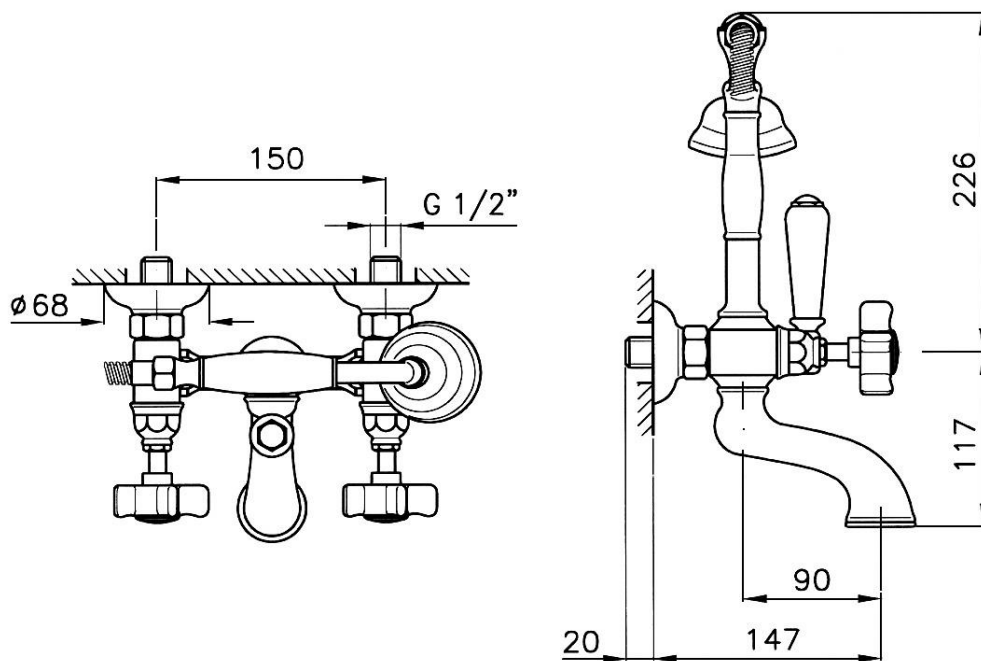

Available replacement handles:

- 
- El Capitan Handle
- 
- 78 Mont Blanc Handle
- 
- 18 Dame Anglaise
- 
- 70 Half Dome

- Handmade in Italy since 1960
- 1/4 Turn valves handmade at Nicolazzi Factory
- Lead Free Brass Compliant to AZ/NZS 3718
- Suitable even and uneven pressure
- Handles are interchangeable



WaterMark

WM22315

AS/NZS3662

Canterbury Sink & Tap Co.

Max/Min Operating
Pressure: 100/500kPa

OFFICINA
NICOLAZZI
DAL 1960

Important Notice Model : Z1401

CAREFULLY READ THROUGH THESE INSTRUCTIONS BEFORE INSTALLATION AND USE OF ALL TAP WARE AND WALL VALVES

INSTALLATION and WARRANTY INSTRUCTIONS

TECHNICAL INFORMATION

All flexible hoses are designed and manufactured for use with water in exposed locations only. Do not expose to household cleaners, chlorine, chloride, hydrochloric acid or other corrosive chemicals.

All connections with threads M10x1 male must be hand tighten. Do not over tighten. Over tightening may cause damage to the hose.

All tap ware washers and o-rings are designed and manufactured for use with water. Do not expose to household cleaners, chlorine, chloride, hydrochloric acid or other corrosive chemicals.

Our tap ware is designed for use with the temperatures and pressures listed below:

- minimum cold water supply 10 °C
- maximum hot water supply 62 °C
- minimum pressure 100 kPa
- maximum pressure 500 kPa
- maximum fixing torque value = 13.6 Nm

Please note: The recommended pressure for best performance is between 270 kPa and 420 kPa. More pressure than 420 kPa or less pressure than 270 kPa may affect the diverting action in side spray tap ware.

Do not use any Nicolazzi tap ware with sulphurous water.

The minimum temperature for all tap ware is 10 degrees Celcius . Below 10 degrees Celcius will void the warranty.

When available, filter systems must be placed between hot and cold supply lines and the tap ware. Improper use or non-use of filters may make diverting tap ware with hand sprays perform poorly.

Don't modify the tap ware and their components.

Use only original spare parts if there are replacements to be ordered. Installation must be made by authorized plumbers or installers. Improper installation or diagnosis of problems is not covered by the warranty. Yearly maintenance of cleaning and flushing is recommended.

Operation and use of any tap ware or wall valve that do not conform to these technical instructions will void the warranty.

Installation Instructions Model : Z1401

Preparation

- Flush out the pipework to remove any foreign matter.
- The hot supply should be on the left when viewed from the front of the fitting.

1 Assembly

- Connect the $\frac{3}{4}$ " male to $\frac{1}{2}$ " female bush adaptors (A), to the $\frac{1}{2}$ " (21mm) water supply pipes.

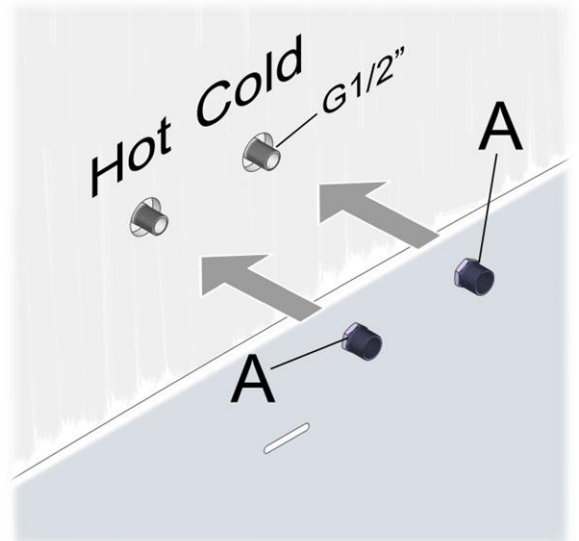

- 2
- Assemble the round cap covers (B), over the Bush adaptors.

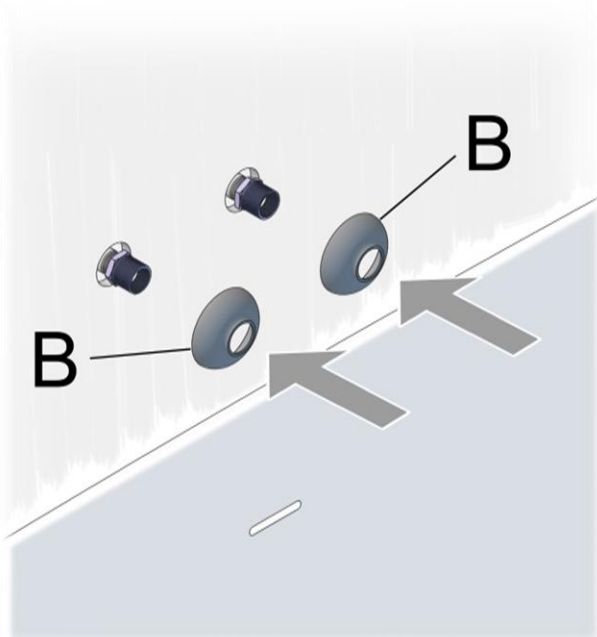

- 3
- Fix the body of the wall mixer (D), placing the fibre washer (C), between the nut and the $\frac{3}{4}$ " male to $\frac{1}{2}$ " female bush adaptors.
 - Ensure all connections are firmly tightened.

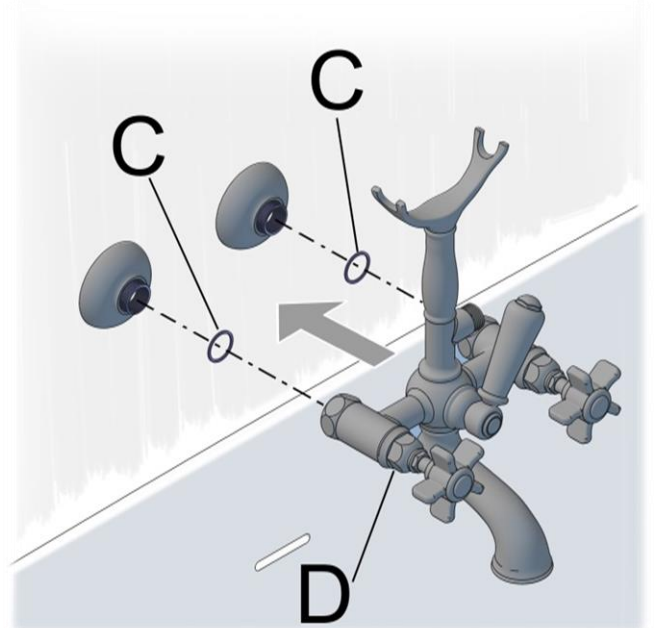

Continue.....

Installation Instructions Model : Z1401

- 4** ■ Attach the flexible hose **F**, onto the thread section of the hand shower body **G**. Include the fibre washer **E**, ensuring it is fitted correctly to prevent leakage. Hand tighten the hose connector nut.

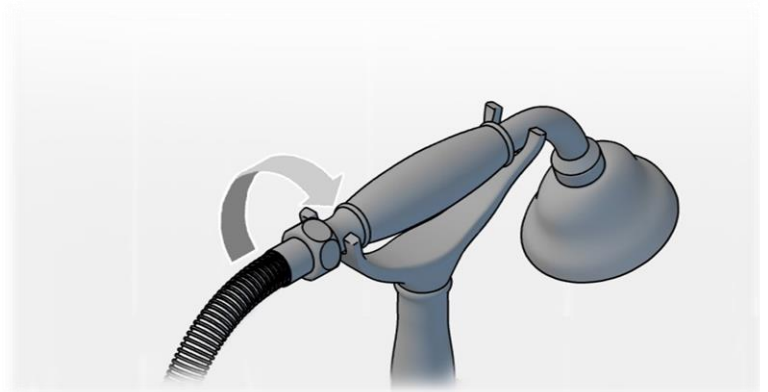
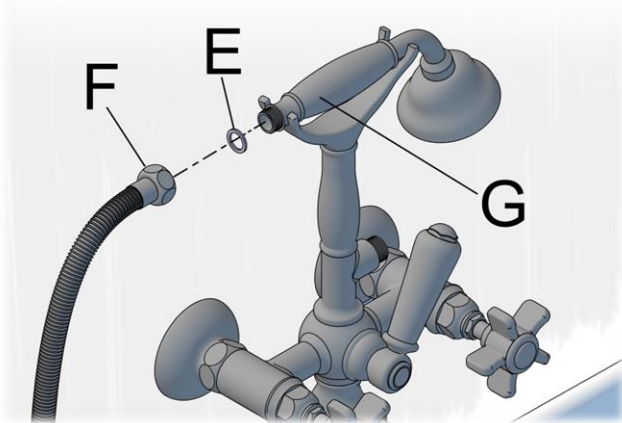

- 5** ■ Next, attach the opposite end of the flexible hose **F**, onto the thread section of the tap body **H**. Include the fibre washer **E**, ensuring it is fitted correctly to prevent leakage. Hand tighten the hose connector nut.

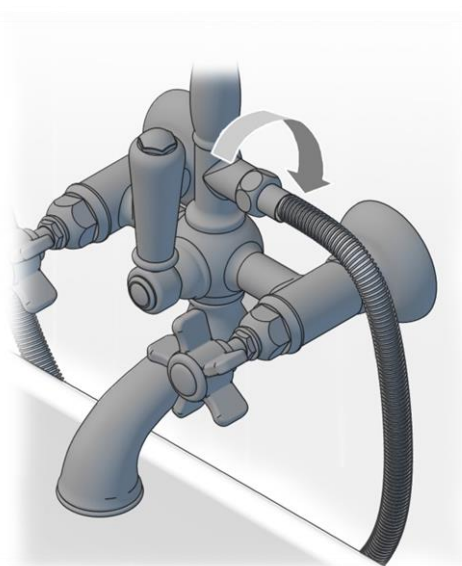
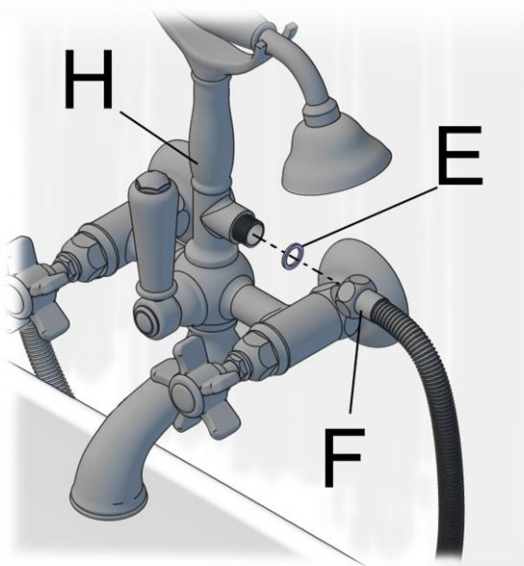

6 **Before use**

- Turn on the Hot and Cold supplies to the tap.
- Maximum temperature for Hot water supply to the tapware is 62 °C.
- Minimum recommended pressure is 100 kPa — Maximum recommended pressure is 500 kPa.
- Check the installation carefully for leaks.
- If further building work is to be carried out in the vicinity of the tapware, it should be covered to prevent paint, adhesive, etc. from damaging the surface.

Spare Parts list Model : Z1401

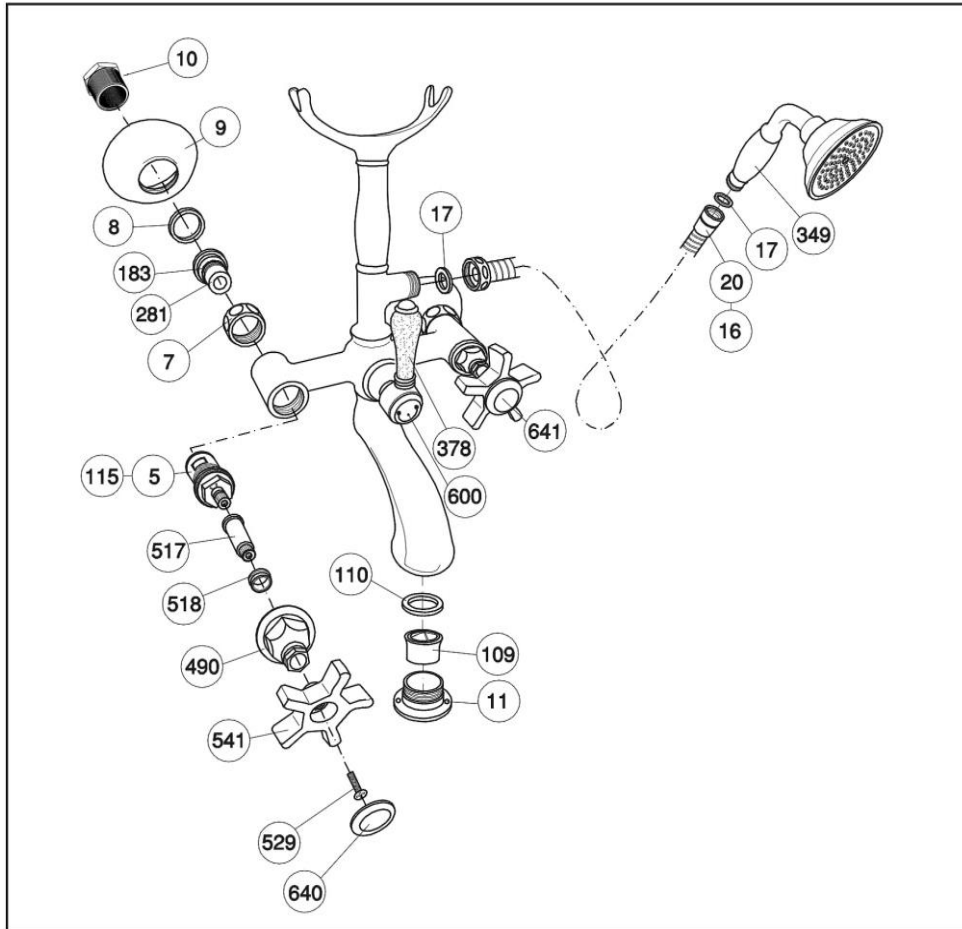

Pos.	Descrizione	Description	Cod.
5	Vitone ceramico disc	Ceramic disc valve	C 7075
7	Calotta per eccentrico G 3/4"	Nut for eccentric G 3/4"	C 7060
8	Guarnizione fibra 24x18x2	Fibre washer 24x18x2	C 7573.1
9	Cappuccio tondo per eccentrico	Round cap for eccentric	C 7212
10	3/4" to 1/2" adapter		
11	Porta aeratore M28x1 Ø46	Aerator holder M28x1 Ø46	C 7087.1
16	Flessibile cm.100 1/2" x 1/2" doppia aggraffatura	Double spiral flexible hose cm.100 1/2"x1/2"	C 7096
17	Guarnizione fibra 18x12.5x2	Fibre washer 18x12.5x2	C 7573
20	Flessibile cm.150 1/2" x 1/2" doppia aggraffatura	Double spiral flexible hose cm.150 1/2"x1/2"	C 7097
109	Aeratore 28 x 1	Aerator 28 x 1	C 7086.28
110	Guarnizione per aeratore 28 x 1	Washer for aerator 28 x 1	C 7086.28
115	Vitone ceramico disc sinistro	Ceramic disc valve left	C 7075SX
183	O-ring Ø16.1x1.6	O-ring Ø16.1x1.6	C 7586.61
279	Tassello plastica Ø 8	Plastic dowel Ø 8	--
281	Sede 22mm.	Seat 22mm.	C 7051
349	Doccia Petit M. Blanc	Petit M. Blanc Handshower	C 7104
378	Deviatore vasca Petit Mont Blanc	Petit Mont Blanc bath mixer diverter	C 7641
490	Coprivitone con premistoppa Dames Anglaises	Cover valve with nut Dames Anglaises	C 7223
517	Asta per coprivitone Dames Anglaises	Rod for head valve Dames Anglaises	C 7225
518	Anello teflon Ø13 - Ø15.4 h.6.5	Teflon ring Ø13 - Ø15.4 h.6.5	C 7627/6
529	Vite 3/16" x 10	Screw 3/16" x 10	C 7550/316
541	Corpo maniglia serie Dames Anglaises	Body only Dames Anglaises handle	C 7618/1
600	Placchetta per deviatore con simbolo vasca/doccia	Plate for diverter with indication bath/shower	C 7698PD
640	Placchetta per maniglia "Caldo"	Plate for handle with indication "Hot"	C 7672P
641	Placchetta per maniglia "Freddo"	Plate for handle with indication "Cold"	C 7672P

Care and Maintenance Instructions Model : Z1401

MAINTENANCE FOR WALL MOUNTED TWO LEVER TAP WARE

INSTRUCTIONS FOR REPLACEMENT OF THE HOT OR COLD CARTRIDGE

Do not replace the cartridge if there is low flow or no flow. Low flow or no flow is caused by obstruction or kinking of supply hoses.

- 1
 - Turn off the hot and cold supply lines to the tap. (Not shown).
 - Remove the handle and retaining flange.
- 2
 - Remove the cartridge with a 17mm spanner or smooth jawed shifter.

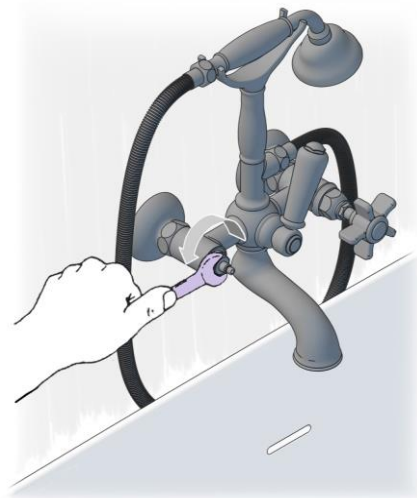
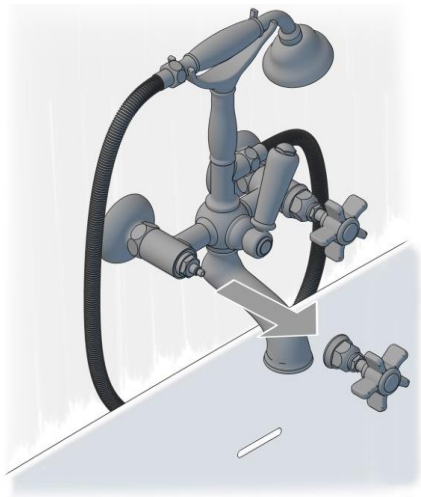

- 3
 - Install new cartridge.
 - Secure the cartridge with a 17mm spanner or smooth jawed shifter.
- 4
 - Install the handle and retaining flange, and hand tighten only. **DO NOT USE A SHIFTER TIGHTEN BY HAND ONLY!**
 - Turn on supply line and test for leaks. (Not shown).

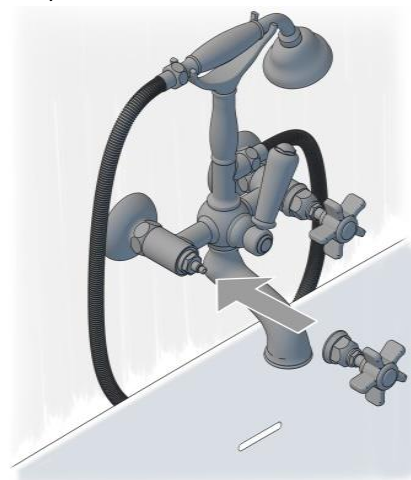
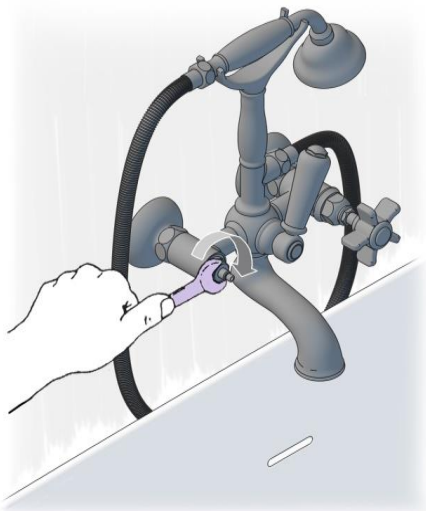

Note: Do not over tighten as this could damage the ceramic cartridge!

Care and Maintenance Instructions Model : Z1401

Removing and replacing a handle

MODEL SHOWN :Z 1401

- 1 ▪ Loosen and unscrew the retaining flange **A**, from the tap body.
- 2 ▪ Once totally loose, simply remove the handle from cartridge spline.

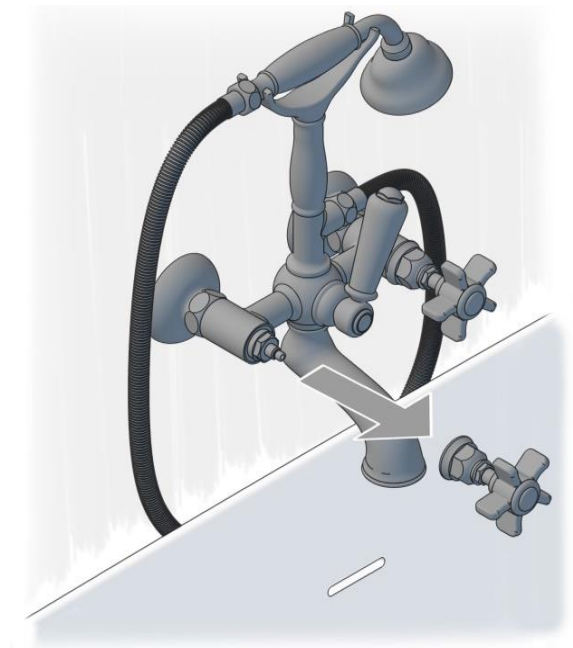
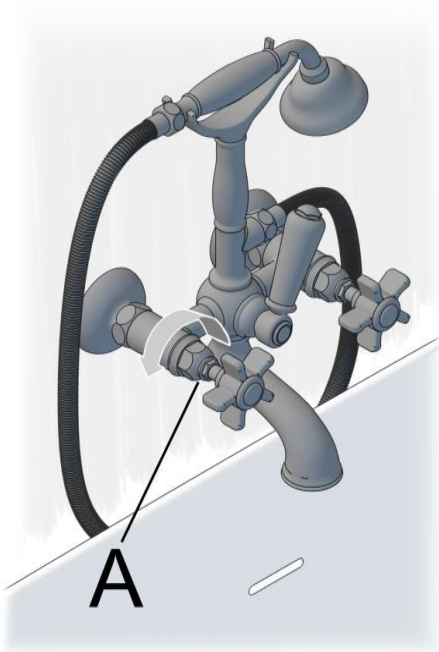

- 3 ▪ To reassemble, reverse the disassembly procedure, given above.
- The retaining flange only needs to be hand tight.

Note: DO NOT USE A SHIFTER TIGHTEN BY HAND ONLY ! Do not over tighten as this could damage the ceramic cartridge!

Available replacement handles:

- El Capitan Handle
- 78 Mont Blanc Handle
- 18 Dame Anglaise
- 70 Half Dome

NOTE: At any time, should the handle feel loose, retighten the retaining flange by hand.

See our video: <https://youbytu.be/PUBD3GHgg58>

Care and Maintenance Instructions Model : Z1401

LOW FLOW OR NO FLOW TROUBLESHOOTING INSTRUCTIONS

Current bathroom taps have a max flow rate of 7 Litres per minute from the aerator.

If you are experiencing low flow from the spout: **Do not change the cartridge**

- Unscrew and clean the aerator -1
- Unscrew and clean the filters inside the supply connections- 2
- Check the supply lines for kinks or obstructions-2
- Make sure the supply line stops are fully on. Not shown

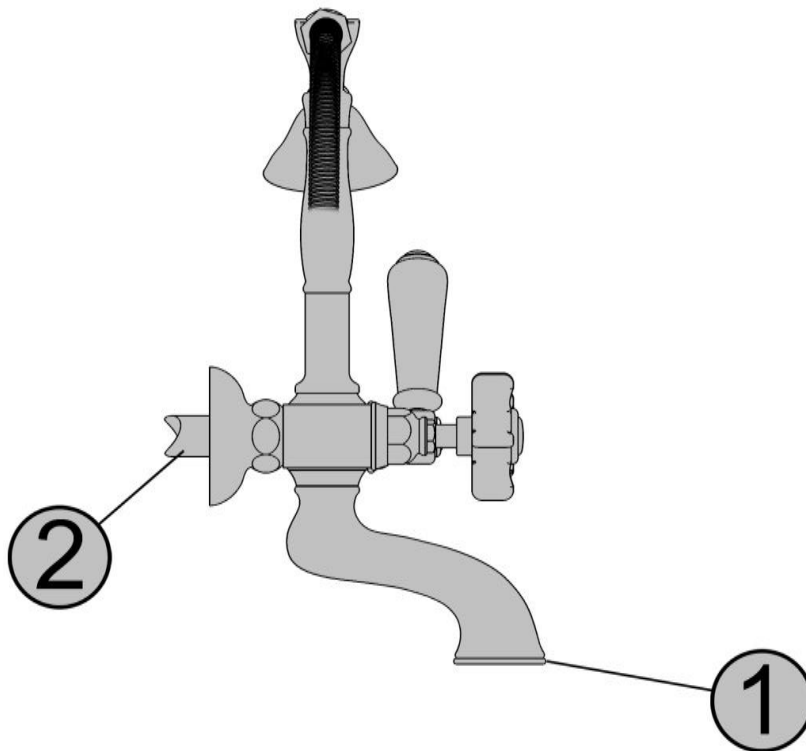

Care and Maintenance Instructions Model : Z1401

Care of external finishes

Nicolazzi products are all authentic finishes that have not been coated with any product. After each use, pat the fixture down to remove any excess water. This will prevent any water spotting or mineral build-up. Use only soft liquid soap and water to clean the surface. Use a soft brush to clean any gaps. Avoid any products that have ammonia or alcohol like Windex, Jif or Ajax. These products can damage the finish leaving black or white spots. Never use on abrasive products on tap ware or this will void the warranty.

Live Finishes DO NOT carry a warranty as they are living finishes and will change over time.

Raw Brass, Brush Brass (To make the brass lighter again rub the brass tap with lemon juice, this will lighten the dark colouring).

Shiny Brass, Polished Nickel has an ageing process and will tarnish over time.

Tuscan Brass is a living finish and also carries NO warranty. It will lighten with use. To extend the life of the finish, apply Bruno's Wax by patting it on, letting it dry and patting it off. Never rub or buff this finish.

WARNING: The use of cleaning products not recommended might irreparably harm the surfaces of the tap, which in such cases are not covered by our warranty.

Lime scale build up

The tap is fitted with an aeration device in the Hot/Cold water outlet.

This may need occasional cleaning especially in hard water areas.

This is accomplished by unscrewing the outlet in a counter clockwise direction, dismantling and leaving the inner screen mesh immersed over night in vinegar