

**LOCKOUT TAGOUT  
SOLUTION >>**



***LOTOPRO***

**By**

**ARCHFORD**





















# LOTOPRO

By  
**ARCHFORD**

## PRODUCTS CATALOG

---

		<b>SAFETY PADLOCK</b>	<b>01 - 04</b>
		<b>VALVE LOCKOUT</b>	<b>05 - 09</b>
		<b>CABLE LOCKOUT</b>	<b>10 - 12</b>
		<b>ELECTRICAL LOCKOUT</b>	<b>13 - 19</b>
		<b>PNEUMATIC LOCKOUT</b>	<b>20 - 23</b>
		<b>LOCKOUT HASP</b>	<b>24 - 28</b>
		<b>LOCKOUT TAG</b>	<b>29</b>
		<b>LOCKOUT BOX &amp; STATION</b>	<b>30 - 31</b>
		<b>LOCKOUT KIT</b>	<b>32</b>

**ALL PRICES ARE EXCLUDING GST**



# SAFETY PADLOCKS

- Different shackle materials and heights for your choice:



- Different body colours of your choice:



- Customizable padlock shackles



# PADLOCK PROFILE CHART

## Padlock Shackle:

- Steel Shackle: 25S,38S,44SD4,76S
- Insulation Shackle: 25P,38P,76P,25PD4
- Cable Shackle: C175,C175D2



## Padlock Body:

- Lockey patented design lock body: CP
- Straight edge plastic lock body: P
- Arc edge plastic lock body: AP
- Striped plastic lock body: BP

## Dangerous label:

The language can be customised

With rewritable warning labels

## Key Retaining Feature:

When the shackle is open, the key can not be removed.



## Unique non-conductive lock cylinder:

The operation process is more secure by preventing electricity travelling from the shackle to the key.

## ● Features

- Reinforced nylon body, ensures the padlock strength and can't be deformed easily. The steel shackle padlock withstands temperature from  $-20^{\circ}\text{C}$  to  $+80^{\circ}\text{C}$ . The non-conductive shackle padlock withstands temperature from  $-20^{\circ}\text{C}$  to  $+120^{\circ}\text{C}$ .
- Widely used in chemical, electrical, automobile industry, etc.
- With rewritable warning signs, other designs can be customised.
- Resistance of chemical, extreme temperatures and UV rays.
- Key Retaining Feature: When the shackle is open, the key can't be removed.
- Laser printing and logo engraving is available if required.
- Several types of lock bodies and different colours available.

# KEY CHARTING SYSTEM

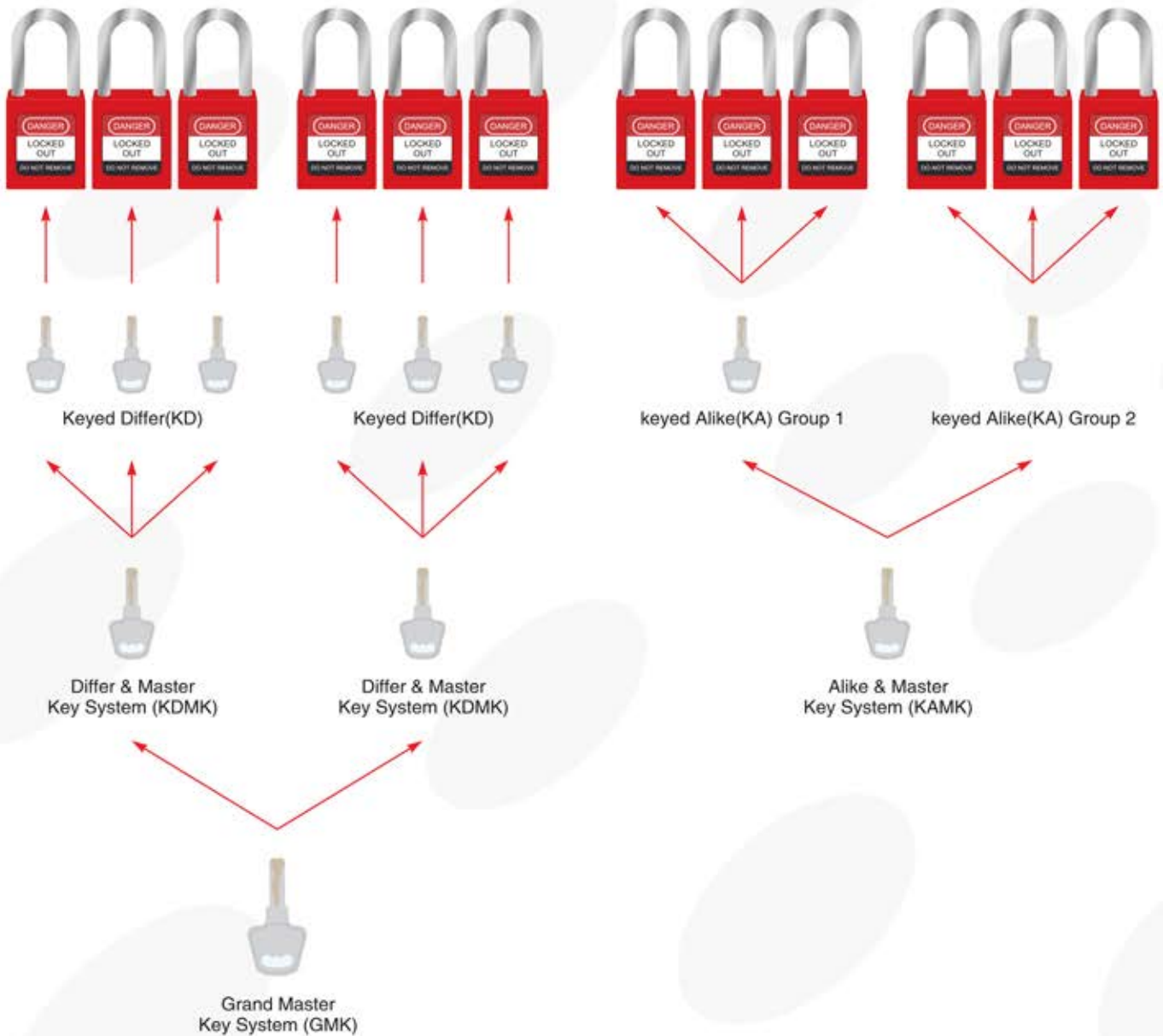

## ● Key Charting System

- Keyed Differ System ( KD): Each padlock is keyed differently, supplied with 1 key per lock. 20000pcs individual locks available.
- Keyed Alike System (KA): Each padlock is keyed the same in one group. 1 key will open all padlocks in each group.
- Differ& Master Key System (KDMK): Each padlock is keyed differently, supplied with 1 key per lock. A master key will override and open any of these padlocks.
- Alike& Master Key System (KAMK): Each padlock is keyed the same in one group. A master key will override and open all groups of Alike keyed.
- Grand Master Key System (GMK): Each padlock is keyed different in one group. A grand master key will override and open all different KDMK groups.

## ● Key Charting Registration

It is important that each employee at a site has a unique padlock key to help prevent duplicate keys from jeopardizing your lockout program. We promise to use different key and numbering for each order if required. Besides each key can be recorded in our programming system so that you can reorder the same key whenever necessary.



### SAFETY PADLOCK SHACKLE LENGTH: 38MM



Part No.	Description	Shackle Material	Specification	Price
KA-P38S	Keyed Alike	Steel	"KA": Each padlock is keyed the same in one group "P": Straight edge plastic lock body "S": Steel shackle	\$18.75
KD-P38S	Keyed Differ			\$18.75
MK-P38S	Master & Alike / Differ			\$21.00
GMK-P38S	Grand Master key			\$26.25
KA-P38P	Keyed Alike	Nylon	Other material can be customised: "SS": Stainless steel shackle "BS": Brass shackle	\$18.75
KD-P38P	Keyed Differ			\$18.75
MK-P38P	Master & Alike / Differ			\$21.00
GMK-P38P	Grand Master key			\$26.25

- Reinforced nylon body, withstand temperature from -20°C to +80°C. The steel shackle is chrome plated; the non-conductive shackle is made from nylon, withstand temperature from -20°C to +120°C, ensuring the strength and deformation fracture not easily.
- Key Retaining Feature: When the shackle is open, the key can't be removed.
- Laser printing and logo engraving available if required.
- All different colours available.

Part No.	Description	Shackle Material	Specification	Price
KA-P76S	Keyed Alike	Steel	"KA": Each padlock is keyed the same in one group "P": Straight edge plastic lock body "S": Steel shackle	\$21.00
KD-P76S	Keyed Differ			\$21.00
MK-P76S	Master & Alike / Differ			\$23.25
GMK-P76S	Grand Master key			\$28.50
KA-P76P	Keyed Alike	Nylon	Other material can be customised: "SS": Stainless steel shackle "BS": Brass shackle	\$21.00
KD-P76P	Keyed Differ			\$21.00
MK-P76P	Master & Alike / Differ			\$23.25
GMK-P76P	Grand Master key			\$28.50

### SAFETY PADLOCK SHACKLE LENGTH: 76MM



- Reinforced nylon body, withstand temperature from -20°C to +80°C. The steel shackle is chrome plated; the non-conductive shackle is made from nylon, withstand temperature from -20°C to +120°C, ensuring the strength and deformation fracture not easily.
- Key Retaining Feature: When the shackle is open, the key can't be removed.
- Laser printing and logo engraving available if required.
- All different colors available.

Available Colours: ● RED, ● YLW, ● BLU, ● DBL, ● GRN, ● ORG, ● PRP, ● BRN, ● BLK, ● WHT, ● GRY

Part No.	Description	A(mm)	B(mm)	C(mm)	D(mm)	Price
LP01	KA, KD, MK	25	6	35	40	\$9.75
LP02		39	6	35	40	\$11.25
LP05		67	6	35	40	\$15.75

### LAMINATED SAFETY PADLOCK



- Made from hardened steel with more durable brass cylinder, anti-cutting and anti-sawing.
- With a plastic cover in the bottom, normally in blue. Other colors available.
- Keyed different, Keyed alike, Master keyed system available.
- Other lock width and shackle length also available.

sales@archford.com.au



## VALVE LOCKOUT





### ADJUSTABLE BALL VALVE LOCKOUT

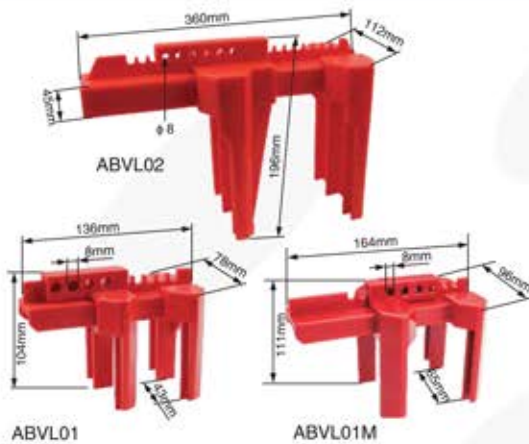

Part No.	Description	Price
ABVL01	Suitable for pipes 1/2" to 2.5" in diameter, OPEN on pipes from 1/2" to 1.25"	\$30.00
ABVL01M	Suitable for pipes 1/2" to 3.15" in diameter, OPEN on pipes from 1/2" to 2.5"	\$52.50
ABVL02	Suitable for pipes 2" to 8" in diameter	\$75.00



- Made from durable ABS, highly resistant of cracking and abrasion and supports extreme weather temperature conditions.
- The two halves of the lockout encompass the ball valve handle to secure it from inadvertent activation of the valve handle.
- Suggested be equipped together with padlocks with max clamping shackle diameter of 8mm.

### STANDARD BALL VALVE LOCKOUT

Part No.	Description	Price
SBVL01	Size: 82mm x 55mm, hole diameter: 10mm	\$41.90
SBVL02	Size: 157mm x 102mm, hole diameter: 10mm	\$61.90
SBVL02-2	Size: 157mm x 102mm, hole diameter: 7.5mm	\$71.90



- Made from hardened steel, surface treatment by high temperature spraying, rust proof.
- The single-piece design locks can quarter-turn ball valves in off position.
- Used on ball valve sizes from 6.35mm (1/4") to 25mm (1"), hole diameter is 3/8".

### ADJUSTABLE GATE VALVE LOCKOUT

Part No.	Description	Price
AGVL01	Suitable for valve handle 1" to 6 1/2" in diameter	\$48.50

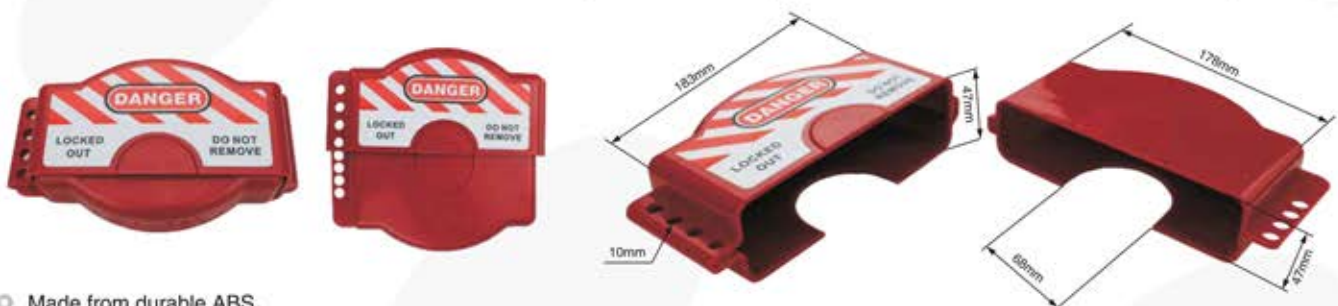

- Made from durable ABS.
- Can be equipped together with padlocks. Padlock locking shackle max diameter 3/8"(9.5mm).
- Can be covered and rotated freely around valve wheel, and adjustable to fit a range of valve handles.



## STANDARD GATE VALVE LOCKOUT

- Made from durable ABS.
- Once locked, it covers around the hand wheel and prevent the valve wheel from being turned.
- Accept up to 1 padlock, locking shackle max diameter 7mm.
- Available in red and 5 sizes. Available in other colours, contact us for more information.
- Available in transparent, contact us for more information.

Part No.	Description	A	B	C	Price
SGVL01	Suitable for valve handle 1" to 2 1/2" in diameter	80	36	20	\$21.50
SGVL02	Suitable for valve handle 2 1/2" to 5" in diameter	142	46	45	\$32.50
SGVL03	Suitable for valve handle 5" to 6 1/2" in diameter	184	53	63	\$45.50
SGVL04	Suitable for valve handle 6 1/2" to 10" in diameter	280	76	89	\$60.50
SGVL05	Suitable for valve handle 10" to 13" in diameter	364	76	105	\$110.50

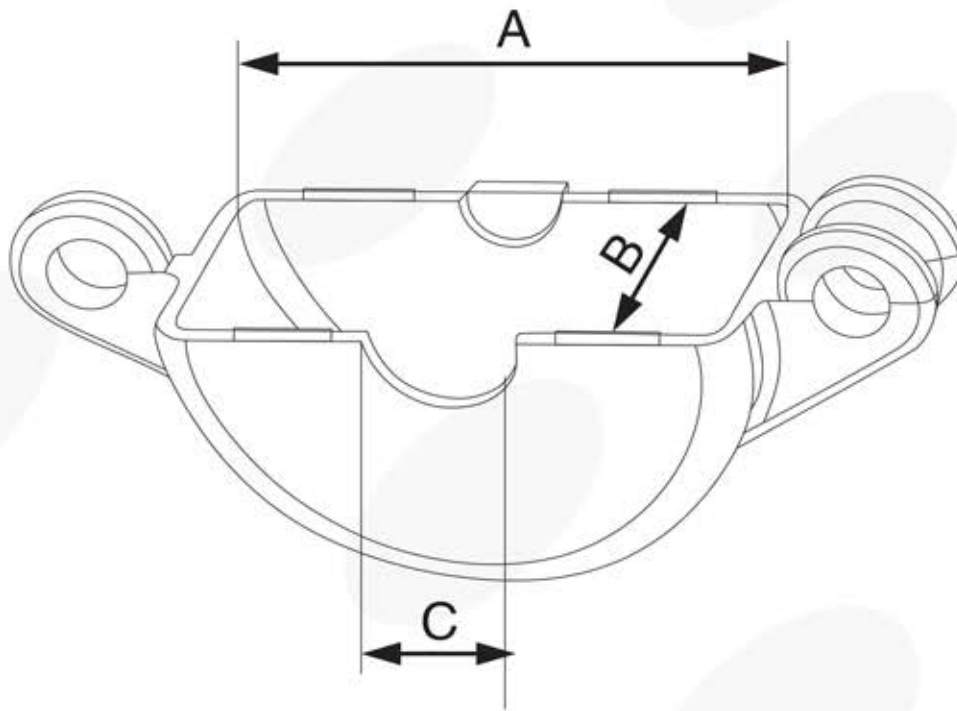

## UNIVERSAL GATE VALVE LOCKOUT

- Made from industrial grade steel and nylon.
- Enables to lock out valves of different types and sizes, such as large levers of valves, T-handles and other hard-to-secure mechanical devices.
- No other device offers such flexibility and security.
- Designed to handle extra impact and resist chemicals making them ideal for just about any environment.
- Max handle width 40mm (handle max thickness 28mm).

Part No.	Description	Price
UVL01	With 1 arm –For quarter-turn ball valves	\$90.00
UVL02	With 2 arm – For 3, 4 or 5-way valves, or to lock valves in the "on", "off", or "throttled" position	\$116.50
UVL03	With coated cable – Using cable attachment for gate valves	\$86.50
UVL04	Base Clamp only – For butterfly valves	\$63.50
UVL05	With 1 arm & coated cable – Universal valve lockout for most valves	\$112.50



UVL01



UVL02



UVL03



UVL04



UVL05

Part No.	Description	Price
UVL04S	Max handle width 25mm (max handle thickness 15mm)	\$56.50

- Made from industrial grade steel and nylon.
- Enables to lock out valves of different types and sizes, such as large levers of valves, T-handles and other hard-to-secure mechanical devices.
- No other device offers such flexibility and security.
- Designed to handle extra impact and resist chemicals making them ideal for just about any environment.
- Can be matched with different fittings to make a series of small universal valves.

## SMALL UNIVERSAL GATE VALVE LOCKOUT





## OVERSIZED CLAMP UNIVERSAL GATE VALVE LOCKOUT

Customized Design



Part No.	Description	Price
UVL04P	Max handle width 40mm (handle max thickness 45mm).	\$76.50

- Made from industrial grade steel and nylon.
- Enables to lock out valves of different types and sizes, such as large levers of valves, T-handles and other hard-to-secure mechanical devices.
- No other device offers such flexibility and security.
- Designed to handle extra impact and resist chemicals making them ideal for just about any environment.
- Can be matched with different fittings to make a series of widened universal valves.

Part No.	Description	Price
Small Arm	Size: 140mm(L)	\$44.50

- Made from industrial grade steel and nylon.
- Used with universal valve lockout base.

## SMALL BLOCKING ARM



## BUTTERFLY VALVE LOCKOUT

Part No.	Description	Price
BVL01	Suitable for valve handle from 8mm to 45mm	\$53.50

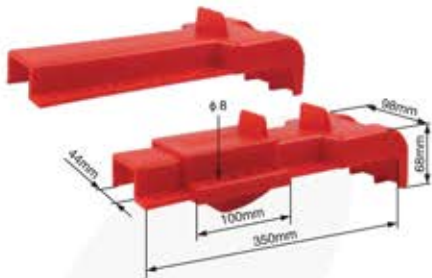

- Made from ABS.
- Good chemical property, resistant to oil stains and chemical product corrosion.
- Can be covered and rotated freely around valve wheels and adjustable to fit all ranges of valve handles.

Part No.	Description	Price
FBVL01	Suitable for 6.35mm(1/4") to 140mm(5") flanged ball valves	\$30.00

- Made from durable ABS.
- Accept up to 1 padlock, locking shackle max diameter 8mm.
- Available in red. Contact us for other colours.

## ADJUSTABLE FLANGED BALL VALVE LOCKOUT





## CABLE LOCKOUT



### ADJUSTABLE STEEL CABLE LOCKOUT

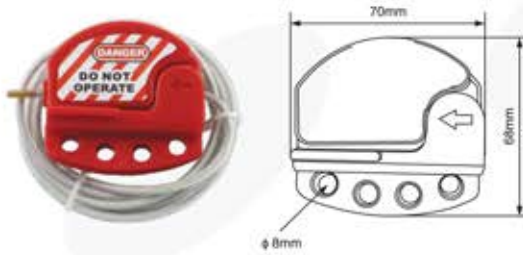

- Lock body: made of ABS, withstands chemicals.
- Cable: tough, flexible multi-stranded steel cable, with clear plastic insulation coating.
- Cable length can be customised.
- Accepts up to 4 padlocks for multiple lockout application.
- Includes high-visibility, re-usable, write-on safety labels. Can be customised.
- Ideal for locking out a single valve or multiple side-by-side valves.



11  
CABLE LOCKOUT

Part No.	Description	Price	CABLE LOCKOUT
CB01-4	Cable diameter 4mm, length 2m	\$40.00	
CB01-6	Cable diameter 6mm, length 2m	\$42.00	

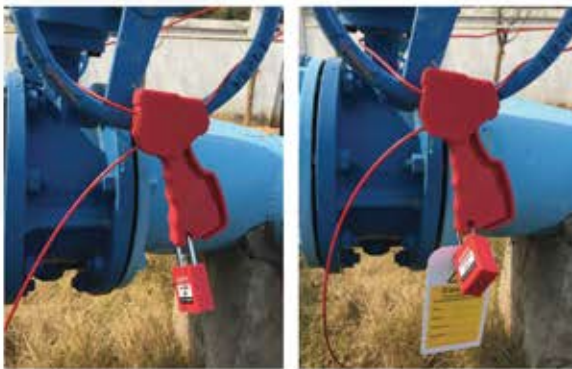

- Lock body: made of glass-filled nylon, withstands chemicals.
- Cable: tough, flexible multi-stranded steel cable, with red insulation coating.
- Cable length can be customised.
- Accepts 1 padlock to lock out.
- Can be equipped together with hasps for multiple lockout usage.

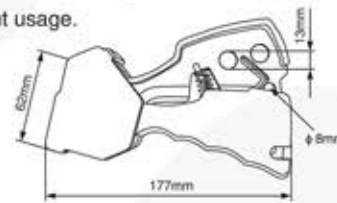

### ADJUSTABLE STEEL CABLE LOCKOUT

Part No.	Description	Price
CB03	Cable diameter 3.8mm, length 2m	\$27.00



Step1

Step2

Step3

- Made from industrial durable nylon, and insulation coated steel cable.
- Designed to effectively lock out a variety of isolation points, including gate valves, "T" valve handles and other hard-to-secure mechanical devices.
- The handle is designed to operate the device without any tools needed.
- Cable length and color can be customised.
- Accepts up to 8 padlocks for multiple lockout application.

### FISH-SHAPED CABLE LOCKOUT

Part No.	Description	Price
CB04	Cable diameter 3.8mm, length 2m	\$30.00

- Lock body made from ABS, with insulation plastic coated steel cable.
- Accepts up to 6 padlocks for multiple lockout application.
- Cable length and color can be customised.
- Includes high-visibility, re-usable, write-on safety labels. Can be customised.

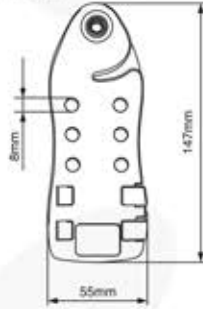

Part No.	Description	Price
CB05	Cable diameter 3.8mm, length 2m	\$27.00

### ECONOMIC CABLE LOCKOUT



Step1

Step2

Step3

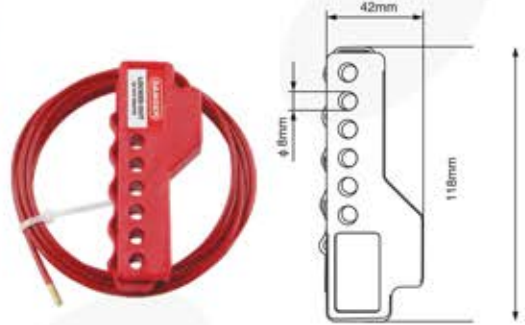

- Made from nylon, with an insulation plastic coated steel cable.
- Accepts up to 6 padlocks for multiple lockout application.
- Non-slip design fits man's hand shape. Very convenient to be used.
- Cable length and colour can be customised.
- Includes high-visibility, re-usable, write-on safety labels.
- Cable length and colour can be customised.





## ELECTRICAL LOCKOUT

### MINIATURE CIRCUIT BREAKER LOCKOUT

Part No.	Description	Price
POS	POS (Pin Out Standard), 2 holes required, fit up to 60Amp	\$10.50



- Made from engineering plastic strengthened nylon PA.
- Applied for most existing types of European and Asian circuit breakers.
- Suggest to be equipped together with a padlock.
- Easily installed, no tools needed.
- Can take a padlock with shackle diameter up to 9/32"(7.5mm).
- Available for single and multi-pole breakers.

Part No.	Description	Price
PIS	PIS (Pin In Standard), 2 holes required, fit up to 60Amp	\$10.50

### MINIATURE CIRCUIT BREAKER LOCKOUT



- Made from engineering plastic strengthened nylon PA.
- Applied for most existing types of European and Asian circuit breakers.
- Suggest to be equipped together with a padlock.
- Easily installed, no tools needed.
- Can take a padlock with shackle diameter up to 9/32"(7.5mm).
- Available for single and multi-pole breakers.

### MINIATURE CIRCUIT BREAKER LOCKOUT

Part No.	Description	Price
POW	POW (Pin Out Wide), 2 holes required, fit up to 60Amp	\$10.50



- Made from engineering plastic strengthened nylon PA.
- Applied for most existing types of European and Asian circuit breakers.
- Suggest to be equipped together with a padlock.
- Easily installed, no tools needed.
- Can take a padlock with shackle diameter up to 9/32"(7.5mm).
- Available for single and multi-pole breakers.



### MINIATURE CIRCUIT BREAKER LOCKOUT

Part No.	Description	Price
TBLO	TBLO (Tie Bar Lockout), no hole in breakers required	\$12.50



- Made from engineering plastic strengthened nylon PA.
- Applied for most existing types of European and Asian circuit breakers.
- Suggest to be equipped together with a padlock.
- Easily installed, no tools needed.
- Can take a padlock with shackle diameter up to 9/32"(7.5mm).
- Available for multi-pole breakers.

Part No.	Description	Price
CBL01-1	Size: 45mm x 25mm x 10mm, max clamping 10mm	\$9.50

### MOULDED CASE CIRCUIT BREAKER LOCKOUT



- Made from engineering plastic strengthened nylon PA.
- Lock out different types of circuit breakers.
- Fits on breaker toggles and can be tightened using screwdriver.

### MOULDED CASE CIRCUIT BREAKER LOCKOUT

Part No.	Description	Price
CBL01-2	Size: 45mm x 25mm x 10mm, max clamping 10mm	\$10.50

#### Patented Design



- Made from engineering plastic strengthened nylon PA.
- Lock out different types of circuit breakers.
- Fits on breaker toggles and can be tightened without tools.

**MOULDED CASE  
CIRCUIT BREAKER LOCKOUT**

Part No.	Description	Price
CBL02-1	Size: 51mm x 25mm x 23mm, max clamping 10mm	\$9.50



- Made from engineering plastic strengthened nylon PA.
- Lock out different types of circuit breakers.
- Fits on breaker toggles and can be tightened by using screwdriver.

Part No.	Description	Price
CBL02-2	Size: 51mm x 25mm x 23mm, max clamping 10mm	\$11.50

**MOULDED CASE  
CIRCUIT BREAKER LOCKOUT**



**Patented Design**



- Made from engineering plastic strengthened nylon PA.
- Lock out different types of circuit breakers.
- Fits on breaker toggles and can be tightened without any tools.

**MOULDED CASE  
CIRCUIT BREAKER LOCKOUT**

Part No.	Description	Price
CBL04	Hole diameter 10mm, need a small screw driver to install.	\$11.50

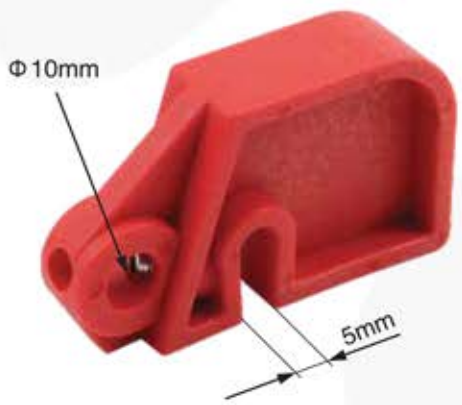

CBL04

- Made from engineering plastic strengthened nylon PA.
- Lock out different types of circuit breakers.



## LARGE MOULDED CASE CIRCUIT BREAKER LOCKOUT

### Patented Design



- Made from engineering plastic strengthened nylon PA.
- Lock out different types of circuit breakers.
- Fits on breaker toggles and can be tightened with a screw driver.
- Can take a padlock with shackle diameter up to 10mm.

## MOULDED CASE CIRCUIT BREAKER LOCKOUT

Part No.	Description	Price
CBL07	7mm ≤ a ≤ 15mm	\$13.50

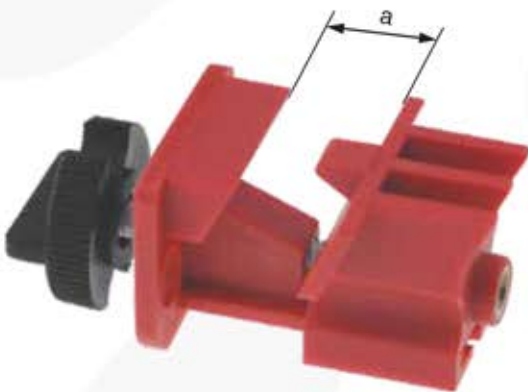

- Wide range of uses: Suitable for all kinds of miniature circuit breakers (handle width ≤ 15mm).
- Made from engineering plastic strengthened nylon PA.
- Self-locking screws, easy to lock without tools.



### CLAMP-ON CIRCUIT BREAKER LOCKOUT

Part No.	Description	Price
CBL11	For 120–277V breaker lockouts, handle width ≤ 16.5mm	\$16.50



- Made of rugged polypropylene and impact modified nylon.
- Can be used with lockout cleats in the bottom for hard locking long sliding switches and switches with large angular rotation.
- Can be easily operated without any tools.
- Accepts padlock shackles up to 9/32" (7.5mm) in diameter.

Part No.	Description	Price
CBL12	For 480–600V breaker lockouts, handle width ≤ 41mm	\$19.50

### CLAMP-ON CIRCUIT BREAKER LOCKOUT



- Made of rugged polypropylene and impact modified nylon.
- Can be used with lockout cleats in the bottom for hard locking long sliding switches and switches with large angular rotation.
- Can be easily operated without any tool.
- Accepts lock shackles up to 9/32" (7.5mm) in diameter.

### CLAMP-ON CIRCUIT BREAKER LOCKOUT

Part No.	Description	Price
CBL13	For large 480–600V breaker lockouts, handle width ≤ 70mm	\$26.50



- Made of rugged polypropylene and impact modified nylon.
- Can be used with lockout cleats in the bottom for hard locking long sliding switches and switches with large angular rotation.
- Can be easily operated without any tools.
- Accepts lock shackles up to 9/32" (7.5mm) in diameter.



### GRIP TIGHT CIRCUIT BREAKER LOCKOUT

Part No.	Description	Price
CBL31	Max clamping 20mm	\$27.50



- ☐ Made from rugged ABS.
- ☐ Fit wide or tall breaker toggles typically found on hi-voltage/hi-ampereage breakers.
- Adjust to breaker with a simple thumb turn and then close clamping handle and lock cover to prevent clamp from being loosened.

Part No.	Description	Price
CBL32	Max clamping 15mm	\$26.50

### GRIP TIGHT CIRCUIT BREAKER LOCKOUT



- ☐ Made from rugged ABS.
- ☐ Fit standard height and tie-bar toggles typically found on 120/240V circuit breakers.
- Adjust to breaker with a simple thumb turn and then close clamping handle and lock cover to prevent clamp from being loosened.

Part No.	Description	Price
GCBL01	The length of the rod is 190mm	\$32.50

### CIRCUIT BREAKER BLOCKING BAR LOCKOUT

- ☐ The base is made of engineering plastic ABS and the main rod is made of nylon PA.
- ☐ The back self-adhesive track can be permanently fixed to the switchboard, simply clean the disk and paste it, without drilling.
- ☐ A perfect lockout solution for oversized or irregularly shaped switches.
- ☐ Coloured bars indicate the switch position. Red bar means the switch is in the off state, green means the switch is in the on state.

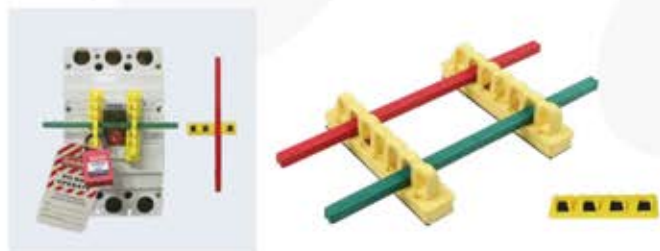



## PNEUMATIC LOCKOUT



### PNEUMATIC QUICK-DISCONNECT LOCKOUT

Part No.	Description	Price
ASL01	Fits 12, 13, 16mm screwed joints.	\$22.50



- Made from engineering plastic nylon PA.
- No need to install a straight interlock valve, can be isolated pneumatic power with lower cost and more convenience.
- Hole in the center of the device allows permanent storage on the air hose and a loop on the side can be used to hang the hose and lockout device.
- Can be equipped with padlocks, lock shackle diameter of 1/4"(6.4mm) or 9/32"(7.1mm).

Part No.	Description	Price
ASL02	Suitable for 7–20mm gas source	\$22.50

Made from 304 stainless steel, corrosion resistance.  
 Prevents pneumatic fitting from being connected to pressurized air source.  
 Fits virtually all male pneumatic fittings found in manufacturing facilities.  
 Measures 1–3/8" wide x 7–3/4" length x 1/8" thick (3.5cm x 19.6cm x 0.3cm).  
 Suitable for 2 padlocks, lock shackle diameter ≤8.5mm.

### AIR SOURCE LOCKOUT

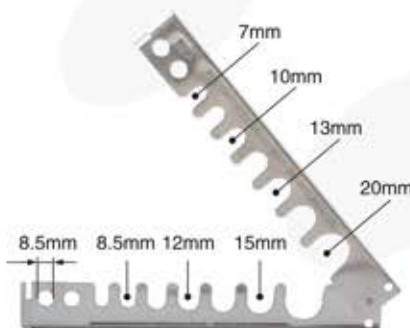

### CYLINDER TANK LOCKOUT

Part No.	A	B	C	D	Price
ASL03	92	41	32	46	\$34.50

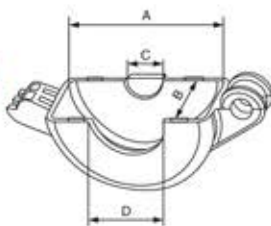

- Made from durable ABS.
- The whole product is metal-free for superior spark proof and chemical resistance.
- Resistant to cracking and abrasion extreme weather and temperature conditions.
- Can be equipped together with hasps and padlocks.

Part No.	Description	Price
ASL04	The neck rings up to 35mm	\$36.50

Made from engineering plastic ABS.  
 Prevent accesses to the main cylinder valve.  
 Accommodates neck rings up to 35mm, and max diameter inside 83mm.  
 Easy and efficient installation to save your time.  
 Can be locked with 2 padlocks, lock shackle diameter up to 8.5mm. Lock with one padlock, lock shackle diameter up to 11mm.

### AIR SOURCE LOCKOUT



## ELECTRICAL PLUG LOCKOUT



Part No.	Description	A	B	C	d1	d2	Price
EPL01	For 110V plugs	90	51	51	13	8	\$19.50
EPL01M	For 220V plugs	120	65	65	18	8	\$25.50
EPL02	For large 220V/500V plugs	178	84	84	26	8	\$28.50

- Made from rugged ABS.
- Prevent plugs from being inserted into the wall outlet, suitable for all kinds of industrial plugs.
- The plug completely sits inside the unit with the cable being fed through an access hole inside.
- Can be locked with 2–4 padlocks, lock shackle diameter up to 7mm.

## EMERGENCY STOP LOCKOUT



Part No.	Description	Price
SBL01	Height: 31.9mm; outer diameter: 49.6mm; inner diameter 22mm	\$6.00
SBL02	Height: 31.9mm; outer diameter: 49.6mm; inner diameter 30mm	\$6.00

- Made from durable transparent PC.
- Fits on press or screw emergency stop button.
- Easily used and permanently prevent workers from operating carelessly.
- Fits both 22mm–30mm diameter switches.



## EMERGENCY STOP LOCKOUT

Part No.	Description	Price
SBL03-1	Accepts lock shackles up to 8mm in diameter.	\$16.50

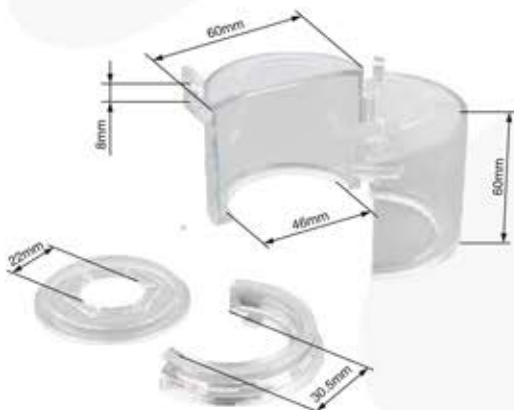

- Made of transparent PC.
- It prohibits access to a switch or control.
- Horse–show shaped retrofit base can be used on raised nameplates and off–center installation to accommodate rotary switch knobs.
- Accommodates buttons up to 50mm diameter and 45mm tall.
- Fits both 30.5mm and 22mm diameter switches.



**SAFETY LOCKOUT BAG**

Part No.	Description	Price
LB11	450mm(L) × 245mm(W)	\$57.50
LB12	660mm(L) × 245mm(W)	\$67.50



- Made from flexible and durable fabric.
- Effectively locks out odd size and large electrical connectors and hoist controls.
- Flexible and durable ripstop nylon bag fits easily in safety tool boxes.
- Text can be customised.



## LOCKOUT HASP





**STEEL  
LOCKOUT HASP**

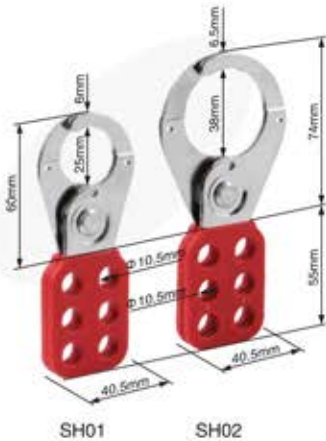

Part No.	Description	Price
SH01	Jaw Size 1"(25mm), accept up to 6 padlocks.	\$12.00
SH02	Jaw Size 1.5"(38mm) , accept up to 6 padlocks.	\$13.00

- Handle is made from PA and lock shackle is made from nickel plated steel with red plastic or vinyl coated body, rust proof.
- Allow multiple padlocks to be used when isolating one energy source.
- Lock holes: 10.5mm in diameter.
- Jaw size: 1"(25mm) & 1.5"(38mm).

Part No.	Description	Price
SH01-H	Jaw Size 1"(25mm), accept up to 6 padlocks.	\$13.00
SH02-H	Jaw Size 1.5"(38mm), accept up to 6 padlocks.	\$14.00

- Handle is made from PA and lock shackle is made from nickel plated steel with red plastic or vinyl coated body, rust proof.
- Steel lockout hasp includes tamper-proof interlocking tabs to prevent unauthorized opening.
- Lock holes: 10.5mm in diameter.
- Jaw size: 1"(25mm) & 1.5"(38mm).

**STEEL LOCKOUT HASP  
WITH HOOK**



**ECONOMIC STEEL  
LOCKOUT HASP**



Part No.	Description	Price
ESH01	Jaw Size 1"(25mm), accept up to 6 padlocks.	\$11.00
ESH02	Jaw Size 1.5"(38mm), accept up to 6 padlocks.	\$12.00

- Made from durable steel with red plastic or vinyl coated body, rust proof.
- Can be locked out by multiple workers on a single energy point, by attaching devices on the equipment.
- Lock holes: 12mm in diameter.
- Jaw size: 1"(25mm) & 1.5"(38mm)

## ECONOMIC STEEL LOCKOUT HASP WITH HOOK



Part No.	Description	Price
ESH01-H	Jaw Size 1"(25mm), accept up to 6 padlocks.	\$12.00
ESH02-H	Jaw Size 1.5"(38mm), accept up to 6 padlocks.	\$13.00

- Made from hardened powder coated steel, durable and resist rust.
- It has a double locking arrangement. Hooks on jaws prevent them to be pulled apart.
- Lock holes: 12mm in diameter.
- Jaw size: 1"(25mm) & 1.5"(38mm).

Part No.	Description	Price
DSH01	Head shackle size: 41mm x 30mm, tail shackle size: 22mm x 17mm, length: 136mm	\$15.50

- Made from red sprayed steel.
- Allow multiple padlocks to be used when isolating one energy source.
- Lock holes: 11mm in diameter.
- Overall length: 136mm, with 22mm and 41mm jaws.

## DOUBLE-END STEEL LOCKOUT HASP

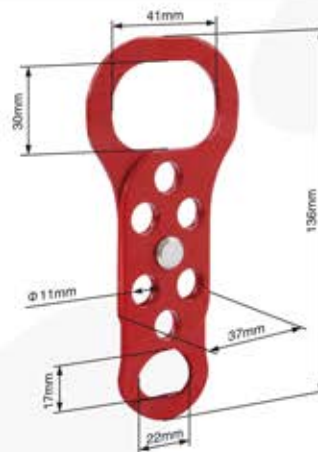

## NYLON LOCKOUT HASP



Part No.	Description	Price
NH01	Overall size: 43.5 x 175mm, accept up to 6 padlocks.	\$7.50

- Made from durable nylon.
- Non-conductive body, applied to electric power isolation with high requirements on corrosive and explosion-proof places.
- Allow multiple padlocks to be used when isolating one energy source.
- Labels can be customized.



## NYLON LOCKOUT HASP

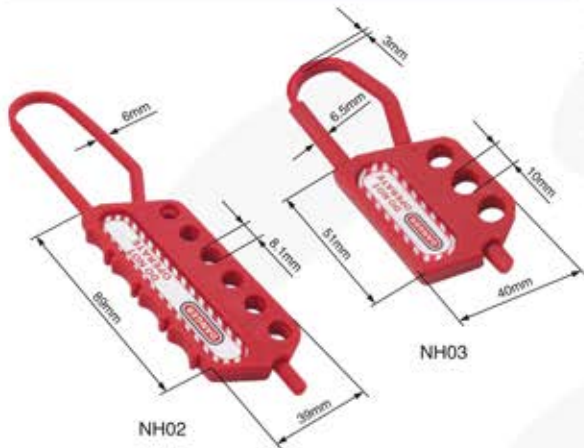

Part No.	Description	Price
NH02	Overall size: 39mm x 190mm, accept up to 6 padlocks.	\$8.50
NH03	Overall size: 40mm x 115mm, accept up to 3 padlocks.	\$8.00

- Made from PP.
- Non-conductive body, applied to lock out electric power isolations with high requirements on corrosive or explosion-proof places.
- Allow multiple padlocks to be used when isolating one energy source.

Part No.	Description	Price
NH04	Overall size: 61 x 107mm, accept up to 4 padlocks.	\$15.00
NH05	Overall size: 61 x 108mm, accept up to 4 padlocks.	\$16.00

- Made from nylon.
- Non-conductive body, applied to lock out electric power isolations with high requirements on corrosive or explosion-proof places.
- With 3 mm or 6 mm shackle diameter available.

## NYLON LOCKOUT HASP



Part No.	Description	Price
AH11	Jaw Size 1"(25mm), accept up to 6 padlocks.	\$10.50
AH12	Jaw Size 1.5"(38mm), accept up to 6 padlocks.	\$11.50

- Made from surface treated and spark proof aluminum shackle with red nylon coated body.
- Allow multiple padlocks to be used when isolating one energy source.
- Lock holes: 10mm in diameter.
- Jaw size: 1"(25mm) & 1.5"(38mm).

## ALUMINUM LOCKOUT HASP



## DOUBLE-END ALUMINUM LOCKOUT HASP

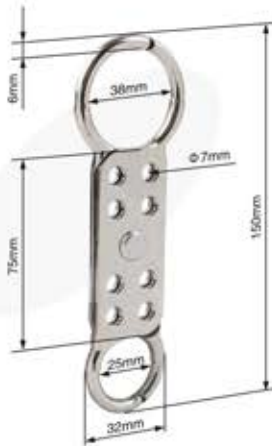

Part No.	Description	Price
DAH01	Head shackle size: 38mm, tail shackle size: 25mm, length: 150mm	\$15.50

- Made from aluminum with surface treatment, spark proof.
- Allow multiple padlocks to be used when isolating one energy source.
- Color can be custom made. Logo printing by laser available.
- Overall length: 150mm, with 25mm and 38mm jaws.

Part No.	Description	Price
LAH03	Overall size: 75mm x 189mm , accept up to 8 padlocks.	\$29.50

- Made from anodized aluminum alloy.
- With tamper-proof locking tabs, allowing multiple padlocks to be used when isolating one energy source.
- With a high visibility, re-usable write-on safety label, accepts pencil, pen or marker for repeated use.
- Label and colour can be customised.



## ALUMINUM LOCKOUT HASP

## BUTTERFLY LOCKOUT HASP

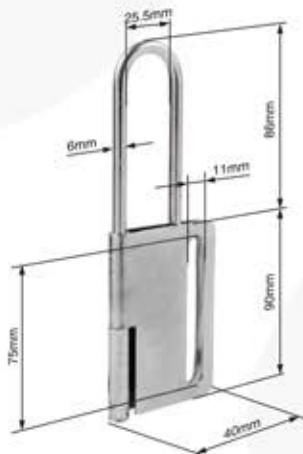

Part No.	Description	Price
BAH02	Overall size: 40 x 176mm, shackle size: 86mm	\$16.00

- Made from hardened heavy duty steel with rust proof coated.
- Allow multiple padlocks to be used when isolating one energy source.
- Keep equipment inoperative while under repairing or adjusting.



## LOCKOUT TAG

### SAFETY WARNING TAG



LT01

LT02

LT03

- Made from PVC material.
- The tag indicates who is responsible for placing the lockout device and who is authorized to remove it or make changes to it.
- Can be written by erasable pen for repeated using.
- Wording and design can be customised.

Part No.	Description	Price
LT01	75mm(W) × 146mm(H) × 0.5mm(T)	\$22.00
LT02	75mm(W) × 146mm(H) × 0.5mm(T)	\$22.00
LT03	75mm(W) × 146mm(H) × 0.5mm(T)	\$22.00



### SCAFFOLD HOLDER TAG



SLT01

SLT02

Part No.	Description	Price
SLT01	Size: 310mm × 92mm, hole diameter: 60mm	\$99.00
SLT02	Size: 213mm × 56mm	\$99.00

- Made from ABS.
- Provides systematic, procedural and legal compliance for scaffolds on work sites.
- Provides a clear inspection trail giving integrity and control of work carried out.
- The tags are available in three durable write-on materials, providing highly visual and eye-catching information.
- Each with a scaffold tag holder and a tag. The tags can be customised





## LOCKOUT BOX & STATION



Part No.	Description	Price
LK02	230mm(W) x 155mm(H) x 90mm(D)	\$125.00

- Made from surface high temperature spraying plastic treatment steel plate and stainless steel nylon handle.
- Several person can lock the important parts at the same time, can accommodate 13 padlocks.
- Can used as mini portable lockout box, can accommodate several tagout, hasp, mini lockout etc.
- Be equipped with the supervisor lock.

### PORTABLE GROUP LOCK BOX



Part No.	Description	Price
LK04	450mm(W) x 600mm(H) x 85mm(D)	\$345.00

- Made from surface high temperature spraying plastics treatment steel plate.
- With 32 padlock positions, each padlock position can hang 2 padlocks or hasps.

Wording and design can be customised.

### MANAGEMENT LOCKOUT STATION



Part No.	Description	Price
LK12	10-lock station 343mm(H)x343mm(W)	\$99.00
LK13	20-lock station 597mm(H)x292mm(W)	\$129.00
LK14	36-lock station 546mm(H)x597mm(W)	\$185.00

- Made from bright and durable acrylic with acrylic lock rails.
- Can accommodate padlocks, tags, hasps.

### LOCKOUT STATION



LK12

LK13

LK14

Part No.	Description	Price
PLS01	140mm(L) x 40mm(W) x 80mm(H), can accommodate 5 padlocks.	\$18.00
PLS02	270mm(L) x 40mm(W) x 80mm(H), can accommodate 10 padlocks.	\$28.00
PLS03	400mm(L) x 40mm(W) x 80mm(H), can accommodate 15 padlocks.	\$38.00
PLS04	530mm(L) x 40mm(W) x 80mm(H), can accommodate 20 padlocks.	\$48.00

- Made from heavy duty steel with durable powder coated finish treatment, which ensures longer life in manufacturing facilities.

### METAL PADLOCK STATION



PLS01

PLS04

PLS02

PLS03





***LOTOPRO***

**By**

**ARCHFORD**

Australian Printing Systems

PO BOX 213

Vermont VIC 3133

E: [sales@archford.com.au](mailto:sales@archford.com.au)

P: 03 8819 1193

[sales@archford.com.au](mailto:sales@archford.com.au)

**ARCHFORD**

**03 8819 1193**

**[sales@archford.com.au](mailto:sales@archford.com.au)**