

# Third Party Training Course

GAZCO - GAS

# MERTIK – MODELS

- ❑ SEQUENTIAL CONTROL SYSTEM

- ❑ MODELS

- ❑ GLASS FRONTED STUDIO RANGE (UNTIL OCTOBER 2011)
    - ❑ OPEN STUDIO RANGE (INFRA RED)
    - ❑ RIVA 2 800 & 1050
    - ❑ LINEA
    - ❑ RIVA VISION LARGE - NO WALL SWITCH (UNTIL OCTOBER 2011)



# MERTIK – GV60 OLD & NEW

❑ OLD – MERTIK IR



❑ NEW – MERTIK IR



# MERTIK – GV60 OLD & NEW

## ❑ OLD – MERTIK RF



## ❑ NEW – MERTIK RF



# MERTIK - CONTROL SYSTEM

## GV60 – RF (RADIO FREQUENCY)



G6R-H4T-GA  
GC0149

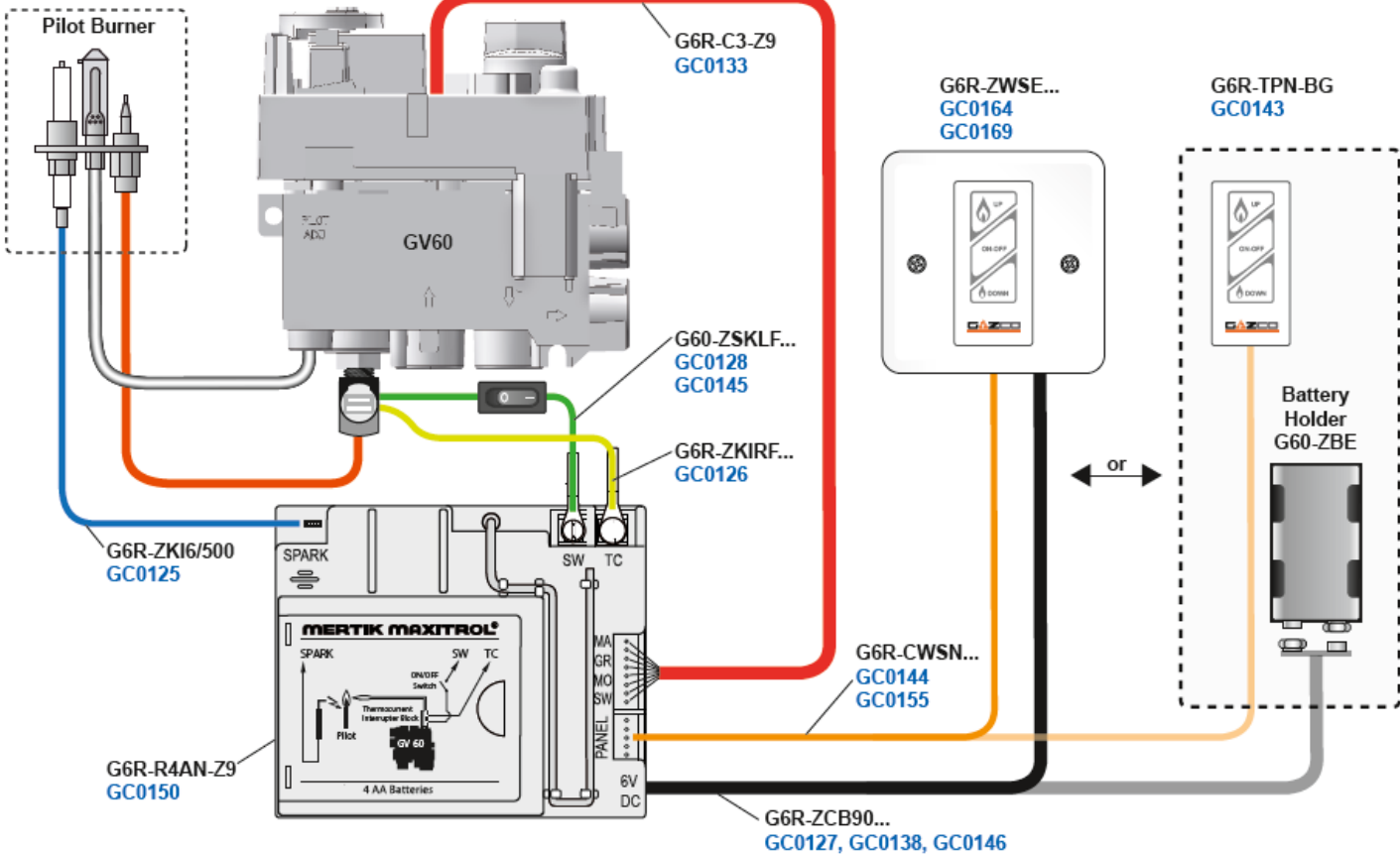



# MERTIK - CONTROL SYSTEM

## GV60 – IR (INFRARED)

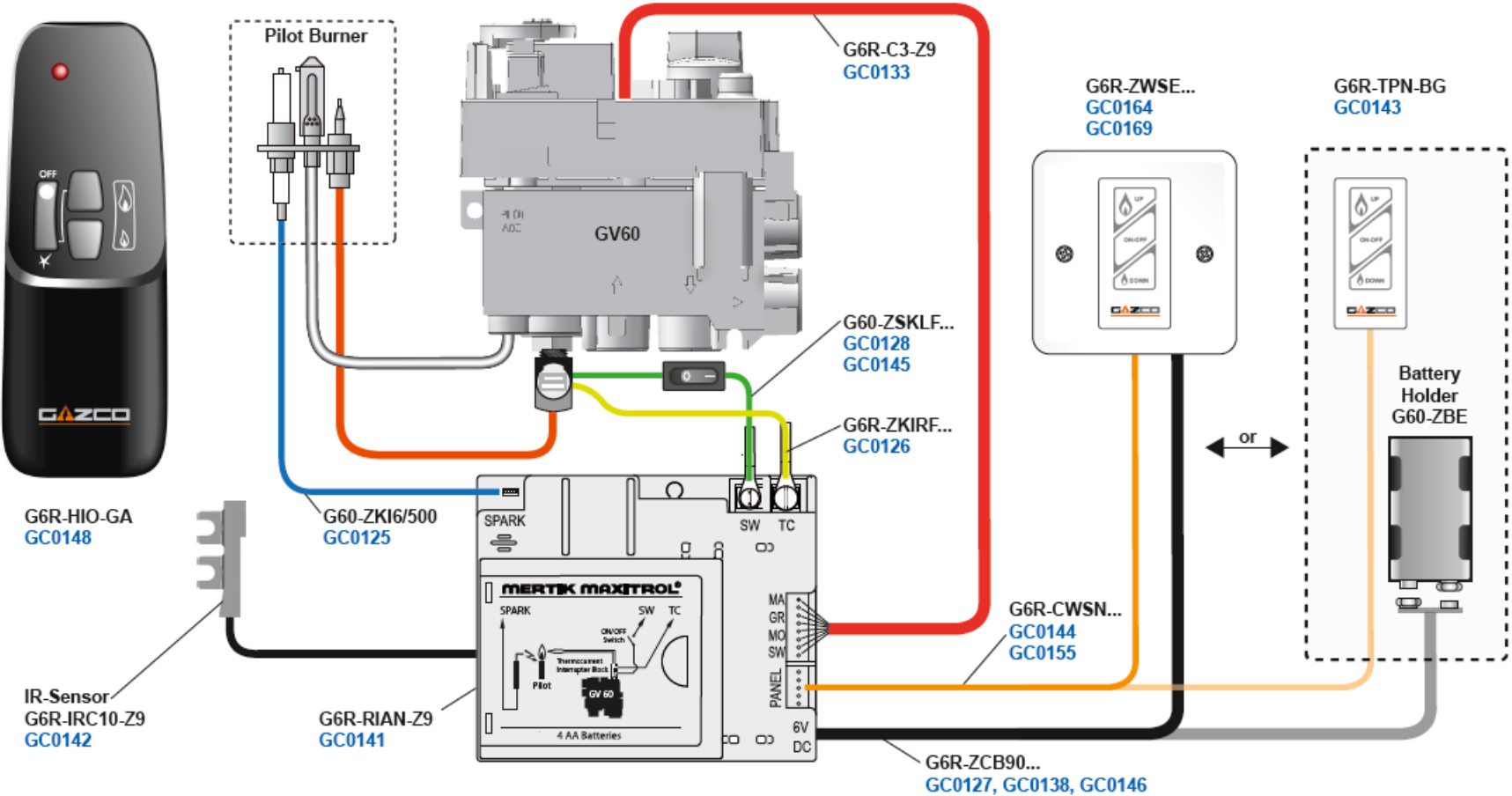

# MERTIK - CONTROL SYSTEM



## TROUBLESHOOTING GUIDE – NO PILOT GAS

## GV60 Remote Electronic Ignition and Control System

### VERIFY THE FOLLOWING BEFORE PROCEEDING

- New batteries
- Kill switch in ON position
- Gas supply is ON
- Good connection between the gas valve and receiver unit

### SERIES OF SHORT BEEPS

- Normal Ignition Sequence has begun.

## ACOUSTIC WARNING SIGNALS

### SIGNAL

- One long beep

### POSSIBLE CAUSE

- Kill switch in OFF (O) position
- Wiring not complete or defective 8-wire cable (Control Valve)
- Microswitch at valve does not work
- Code learning failed

### SOLUTION

- Kill switch to ON (–) position
- Check wiring or replace 8-wire cable (Control Valve)
- Reset the electronics code
- Replace gas valve

### SIGNAL

- Three short beeps (while motor is turning)

### POSSIBLE CAUSE

- Low batteries in receiver

### SOLUTION

- Replace batteries

## OBSERVED PROBLEMS

NOTE: To perform the following tests, set your multi-meter to the 200mV/DC scale.

### NO PILOT GAS

#### POSSIBLE CAUSE

- DC Magnet fails to open

#### SOLUTION

- Begin ignition sequence. If you do not hear the sound of the DC magnet opening (a clunking sound) and the magnet has not opened:
- Replace the receiver unit
- Replace the 8-wire cable
- Replace the gas valve

#### POSSIBLE CAUSE

- Magnet unit opens, but no pilot gas

#### SOLUTION

- Begin ignition sequence. You should hear the sound of the DC magnet opening (a clunking sound) followed by the ignition sparking but magnet will not hold:
- Replace the magnet unit (CE only)
- The thermo current cable is wired incorrectly. Check wiring.
- (G60-ZUF..version only) Plastic insert w/cables could be incorrectly inserted into the interrupter block. Check plastic insert.
- The interrupter block may be damaged from over-tightening. Change the interrupter block.

# MERTIK - CONTROL SYSTEM

## ☐ TROUBLESHOOTING GUIDE – NO PILOT GAS

### PILOT DROPS OUT AS MOTOR TURNS AND OPENS MAIN GAS

At this moment the voltage generated from the receiver stops, and the thermocouple takes over.

#### SOLUTION

- If the thermocouple on the first trial does not generate enough voltage to hold open the magnet, ignition stops. (i. e. ODS Pilots) (Do not hit reset button or change batteries.) Try a second ignition that will increase pilot lighting sequence to 20 seconds.
- Check that the pilot burner is generating enough voltage (see figure 1). Measure the voltage between the larger screw (with red dot) on the receiver unit and any metal part of the gas valve. At the point the thermocouple takes over and the motor turns and opens, the voltage reading should be more than 12 mV for Oxypilot and 20 mV for other pilot burners. This is the voltage being created by the pilot burner in an open circuit (It is independent of the resistance in the circuit) and only a short at the interrupter (see figure 2) could cause failure.

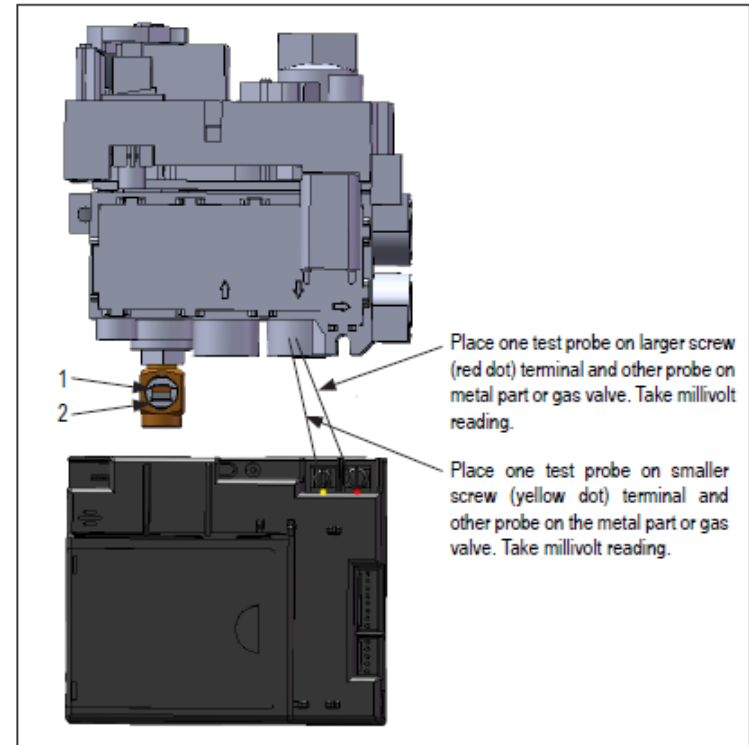

Figure 1

- Check the voltage the thermocouple is generating (see figure 3). Disconnect the thermocouple from the interrupter block and place one probe at the end of the thermocouple contact area and the other probe on the body of the thermocouple. Begin ignition sequence. At the point the thermocouple takes over and the motor on the gas valve turns and opens, take a voltage reading. With this reading you can determine if it is a pilot/thermocouple issue or a short at the interrupter block.



# MERTIK - CONTROL SYSTEM

## ☐ TROUBLESHOOTING GUIDE – NO PILOT GAS

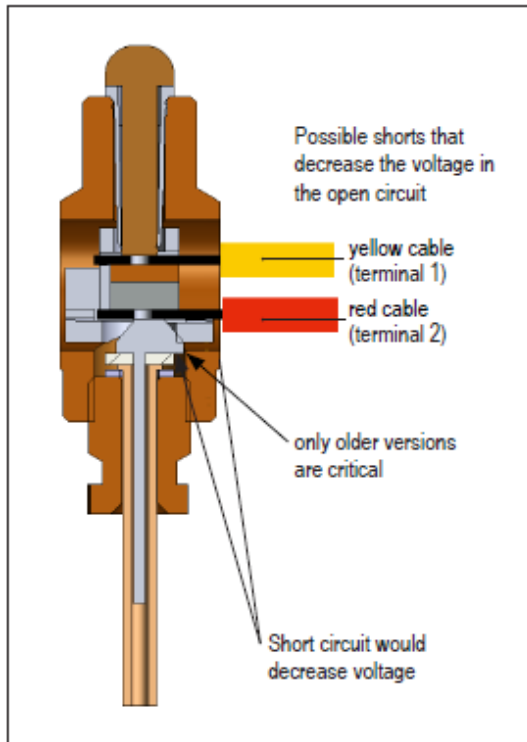

Figure 2

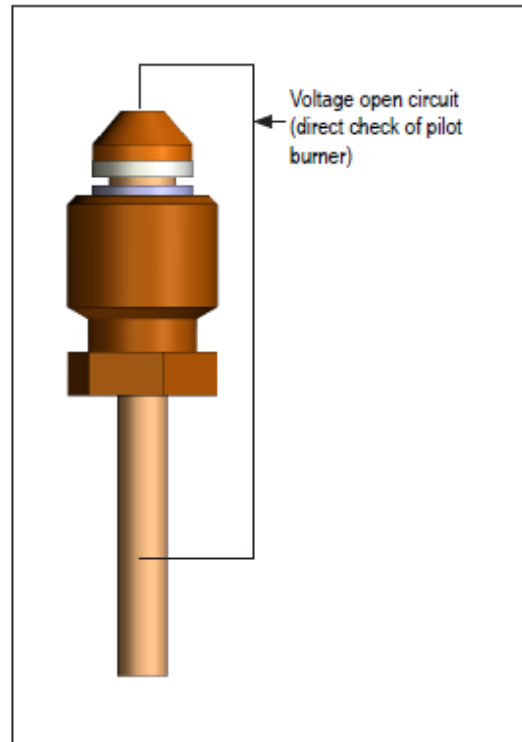

Figure 3

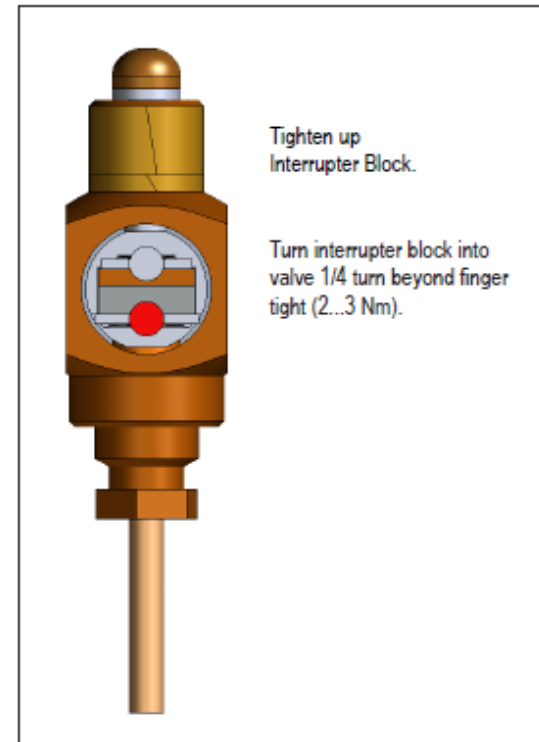

Figure 4

- If the voltage is correct, check for increased resistance in the circuit. Measure the voltage between the smaller screw (with yellow dot) on the receiver unit and any metal part of the gas valve. Begin the ignition procedure. At the point the thermocouple takes over and the motor on the gas valve turns and opens, take a voltage reading. The power supply to the magnet unit changes from the electronic voltage (not sensitive against high resistance) to the thermocouple voltage.

- Begin ignition sequence.
- More than 5.5 mV but the pilot drops out – the increased resistance is either at the kill switch, the interrupter block terminal 1, or in the safety magnet unit (see figure 4).
- Less than 5.5 mV – the increased resistance is in the interrupter block terminal 2 (see figure 2), the receiver unit, or the thermocouple.

# MERTIK - CONTROL SYSTEM

## ❑ TROUBLESHOOTING GUIDE – NO PILOT GAS

### IGNITION SEQUENCE STOPS BEFORE SPARKING STARTS (Acoustic Warning Signals)

#### SIGNAL

- Ignition sequence fails and beeping stops (2008 and earlier versions only).

#### POSSIBLE CAUSE

- Poor battery quality.

#### SOLUTION

- Check for low battery signal (3 beeps) by turning the motor with the handset or touchpad. Replace batteries.

#### SIGNAL

- One long beep (see page 1)

#### POSSIBLE CAUSE

- Kill switch in OFF (0) position
- Thermocouple wiring open
- Microswitch at valve does not close (e.g. knob of the motor valve is out of position because of damage.)

#### SOLUTION

- Check wiring and kill switch
- If kill switch does not work, replace gas valve

### IGNITION SEQUENCE STOPS DURING SPARKING

#### POSSIBLE CAUSE

- Try turning the motor up or down using the handset. If this is not possible without a reset or disconnecting the batteries for a short time, the receiver unit has crashed. This is the only failure that can be caused by a poor ground connection. It may occur when using long ignition cables in combination with a pilot burner that is insulated from the main burner and connected with flexible piping. Also, it can occur occasionally in the lab when rubber hose is used, but very seldom in the field.

#### SOLUTION

- If possible, use a shorter ignition cable and run the ground wire from the pilot burner to the valve.

# MERTIK – TROUBLESHOOTING

## INSTALLER FLOW CHART

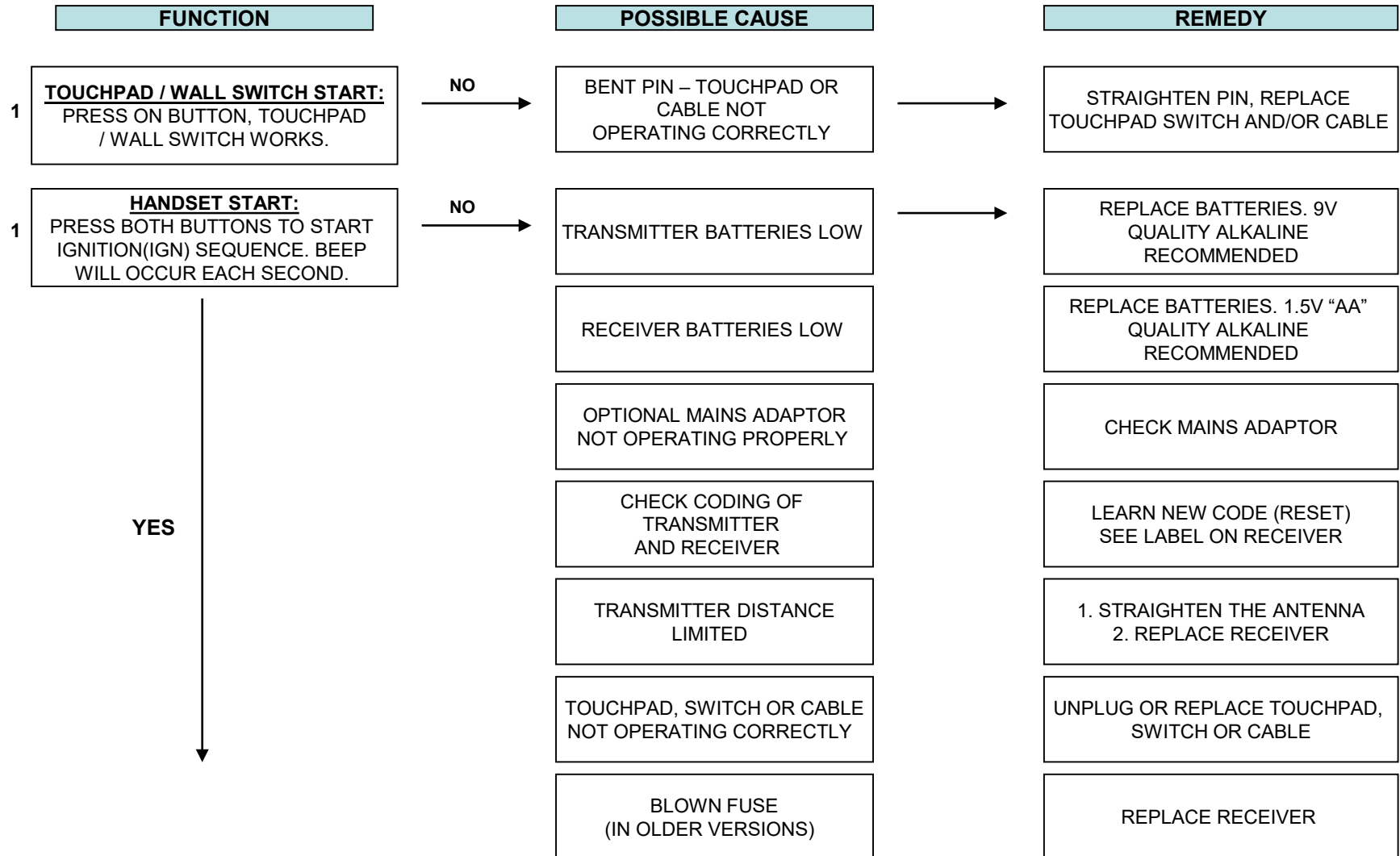

# MERTIK – TROUBLESHOOTING

## INSTALLER FLOW CHART

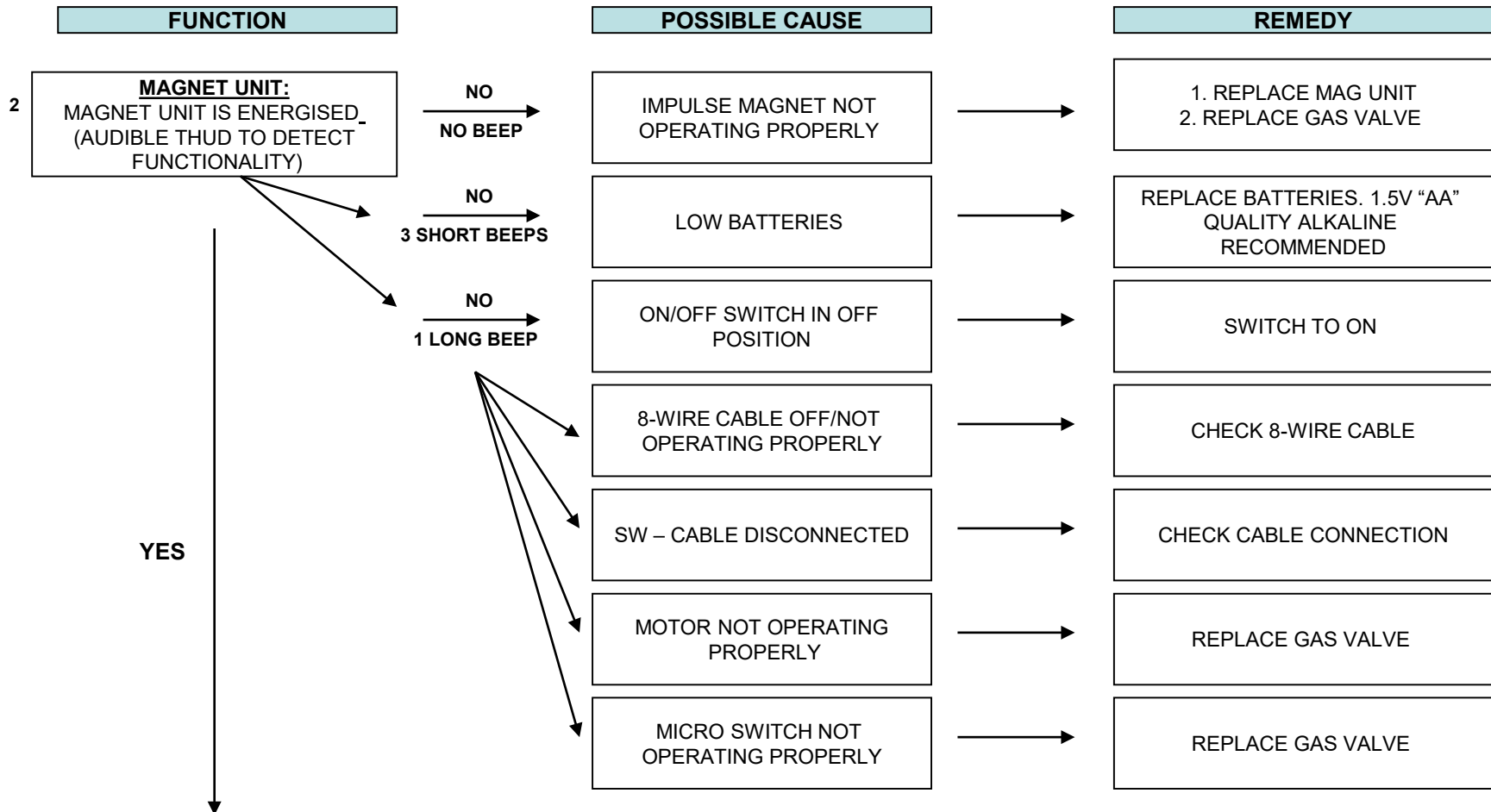

# MERTIK – TROUBLESHOOTING

## INSTALLER FLOW CHART

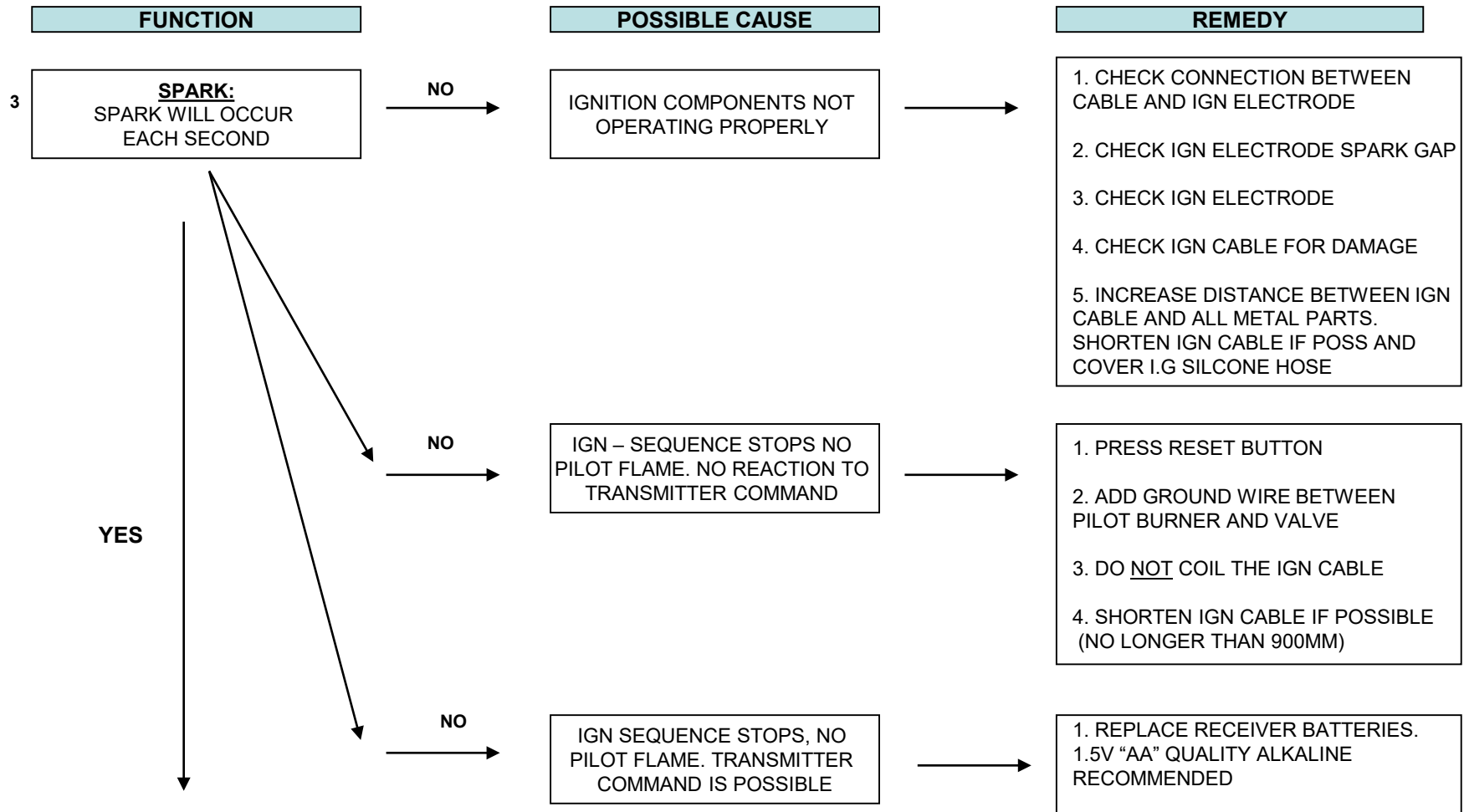



# MERTIK – TROUBLESHOOTING

## INSTALLER FLOW CHART

FUNCTION	POSSIBLE CAUSE	REMEDY
4 <b>PILOT LIT:</b>	NO → TC- AND SW-CABLE REVERSED	CHECK CONNECTION OF CABLE TO RECEIVER AND INTERRUPTER (FIGURE 1)
	NO → MAGNET UNIT NOT OPERATING PROPERLY	REPLACE GAS VALVE OR MAGNET UNIT
	NO → SHORT BETWEEN INTERRUPTER AND SW CABLE	CHECK CONNECTION TO INTERRUPTER
	NO → NO GAS – MAG UNIT DROPS AFTER 30 SECOND AUDIBLE COUNT	CHECK GAS SUPPLY

YES

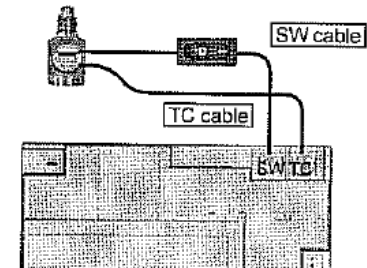
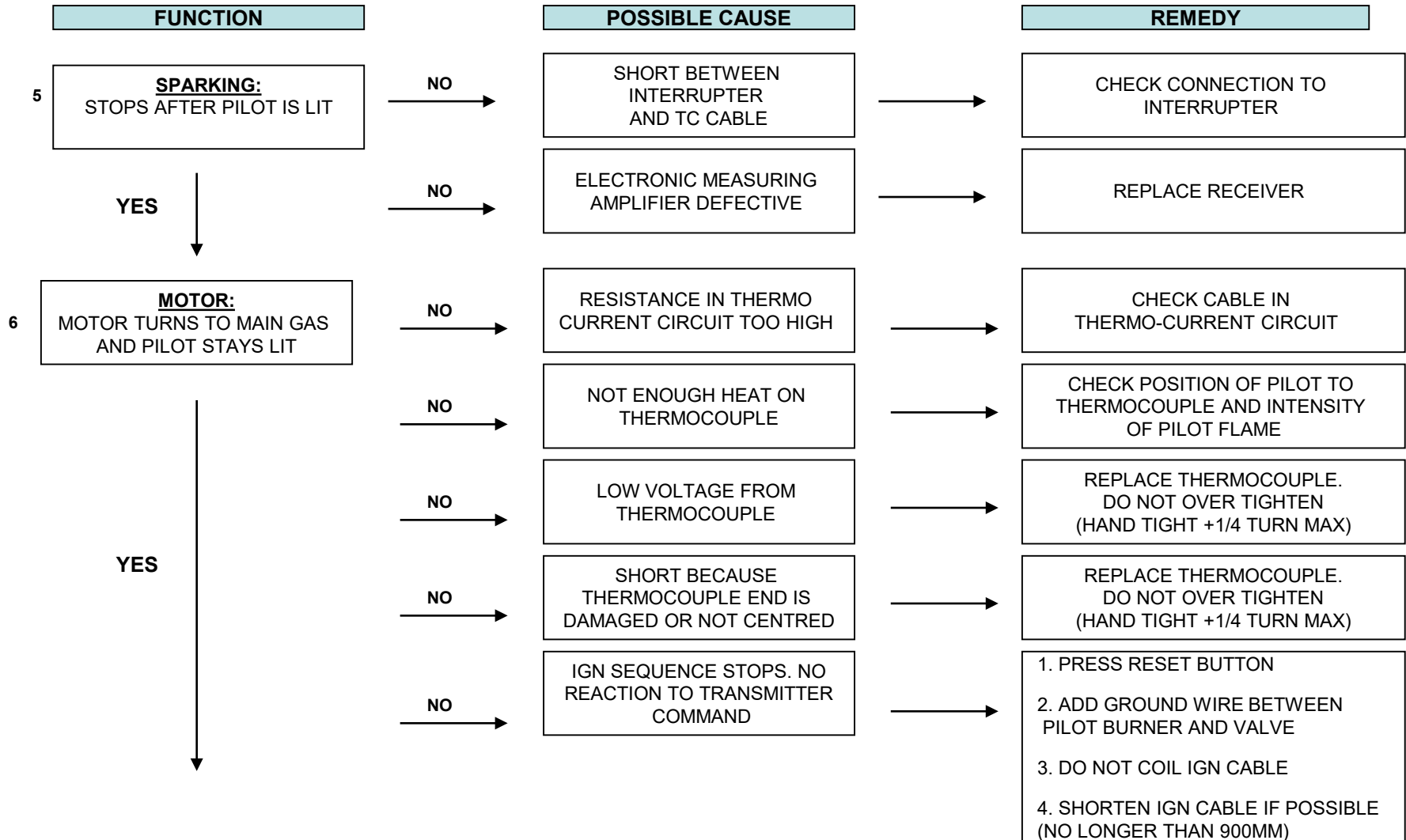

FIGURE 1

# MERTIK – TROUBLESHOOTING

## INSTALLER FLOW CHART



# MERTIK – TROUBLESHOOTING

## ☐ INSTALLER FLOW CHART

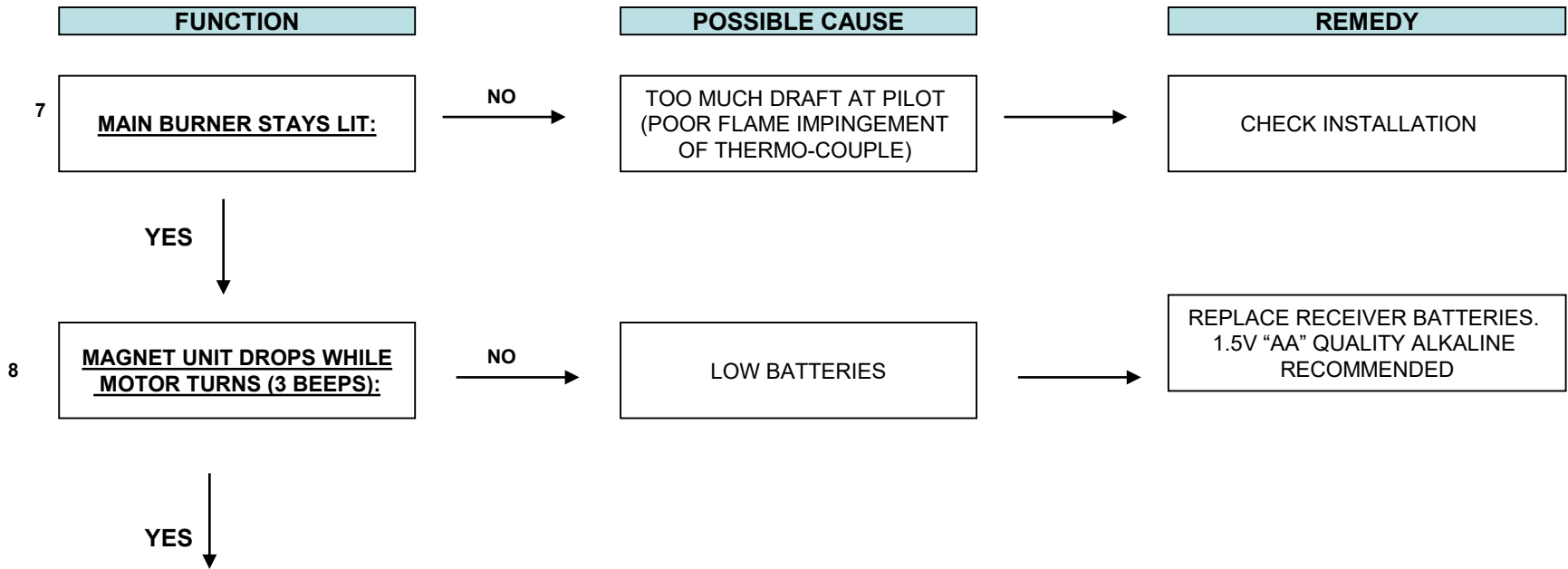

# MERTIK – TROUBLESHOOTING

## ❏ INSTALLER FLOW CHART

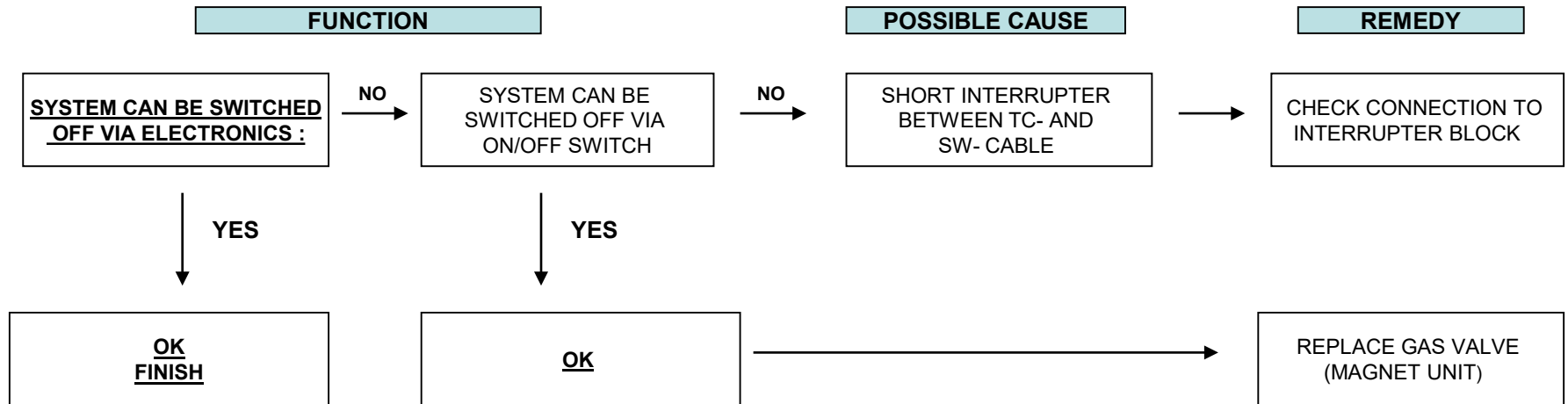

# MERTIK – TROUBLESHOOTING

## OPERATING INSTRUCTIONS

### APPLICATION

GV80 is a battery-powered electronic remote ignition and control system for gas appliances with pilot burners and ODS systems.

### GENERAL NOTES

#### Radio Frequency Remote

433.92 MHz for Europe;  
315 MHz for U.S. (FCC ID: RTD-G6R) and for Canada (IC: 4943A-G6R).

This device complies with part 15 of the FCC Rules. Operation is subject to the following two conditions: (1) This device may not cause harmful interference, and (2) This device must accept any interference received, including interference that may cause undesired operation. Changes or modifications not expressly approved by the party responsible for compliance could void the user's authority to operate the equipment.

#### Batteries - Remote Handset:

1 x 9V block (quality alkaline recommended)

#### Batteries - Receiver:

4 x 1.5V "AA" (quality alkaline recommended)

An AC Mains Adapter may be used instead of batteries (only the Mertik Maxitrol or an AC Mains Adapter approved by Mertik Maxitrol can be used).

**NOTE:** During a power outage the AC Mains Adapter must be unplugged from the receiver to operate in the battery mode.

### AUTOMATIC OPERATION

#### ▲ WARNING

Wiring of valve and receiver must be completed before starting ignition. Failure to do so could damage the electronics.

**NOTE:** These remote handsets, receiver, wall switches, switch panels and touch pads are not interchangeable with previous versions.

For all lighting/ignition instructions please refer to appliance manufacturer's instructions.

### SETTING THE ELECTRONICS CODE

(First time use only)

#### Radio Frequency Remote

(see figures 10, 11, 12)

A code is selected automatically for all Mertik Maxitrol electronics from among 85,000 random codes available. The receiver has to learn the code of the handset:

- Press and hold the receiver's reset button (see figure 8) until you hear two (2) acoustic signals. After the second, longer acoustic signal, release the reset button.
- Within the subsequent 20 seconds press the  (small flame) button on the remote handset until you hear an additional long signal confirming the code is set.

**NOTE:** This is a one time setting only, and is not required when changing the batteries in the remote or receiver.



Figure 8: Receiver reset button

### TO TURN ON APPLIANCE

#### ▲ WARNING



When pilot ignition is confirmed, motor turns automatically to maximum flame height.

- Turn **MANUAL** knob to the ON, full counterclockwise position (see figure 16).
- Place ON/OFF switch (if equipped) in  (ON position).

#### Standard, Display, Timer/Thermostat RF Remote Handset (see figures 10, 11, 12)

- Simultaneously press and hold the **OFF** and  (large flame) buttons until a short acoustic signal confirms the start sequence has begun; release buttons.
- Continuing signals confirm the ignition is in process.
- Once pilot ignition is confirmed, there is main gas flow.
- After the ignition the remote will go automatically into temperature control mode (CSA-versions) or manual mode (CE-versions).

#### Infrared Remote Handset (see figure 9)

- Simultaneously press and hold  (star) and  (large flame) until a short acoustic signal confirms the start sequence has begun; release buttons.
- Continuing signals confirm the ignition is in process
- Once pilot ignition is confirmed, there is main gas flow.



# MERTIK – TROUBLESHOOTING

## OPERATING INSTRUCTIONS

### Wall Switch/Touch Pad/Switch Panel

(see figure 13)

- Press and hold button "B" (see figure 13) until a short acoustic signal confirms the start sequence has begun; release button.
- Continuing signals confirm the ignition is in process.
- Once pilot ignition is confirmed, there is main gas flow.

**NOTE:** If the pilot does not stay lit after several tries, turn the main valve knob to OFF and follow the instructions "Turn Off Gas to Appliance" (see page 5).

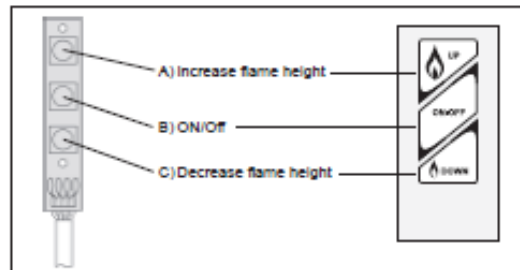



Figure 13: Switch Panel and Wall Switch/Touch Pad

### TO TURN OFF APPLIANCE

Press OFF button on remote handset. Press ON/OFF button on wall switch and touch pad. Press OFF on switch panel (see figure 13 on page 2, button "B").

**NOTE:** Press  (small flame) to turn main gas to pilot gas.

### TO OPEN AND CLOSE SOLENOID VALVE/BURNER

**NOTE:** The latching solenoid valve will not operate for one minute after ignition.

The latching solenoid valve cannot operate manually. If the battery runs down it will remain in the last operating position. During normal operation the solenoid valve will be reset into the ON position when the GV80 is switched OFF remotely.

- Upon ignition both Burner and Decorative Burner are ON.
- Press upper left and lower right button simultaneously to switch the Burner OFF (printed instructions are located on the battery cover, see figure 14).
- Press upper left and upper right button simultaneously to switch the Burner ON. (Display and Timer/Thermostat Remote Handsets: the AUX symbol on the display will indicate that the solenoid valve is OPEN.)



Figure 9: Infrared Remote Handset



Figure 10: Standard RF Remote Handset



Figure 11: Display RF Remote Handset



Figure 12: Timer/Thermostat RF Remote Handset





Figure 14: Instructions for Latching Solenoid Valve (backside of the remote)

# MERTIK – TROUBLESHOOTING



## OPERATING INSTRUCTIONS

### ADJUSTMENT - FLAME HEIGHT

Standard, Display, Timer/Thermostat RF Remote Handsets (see figures 10, 11, 12)

- In standby mode: Press  (large flame) to increase flame height.
- Press  (small flame) to decrease flame height or to set appliance at pilot flame.
- For fine adjustment tap the large/small flames.

Infrared Remote Handset (see figure 9)

- To increase flame height press  (star) and  (large flame) buttons simultaneously.
- Press  (small flame) to decrease flame height or to set appliance at pilot flame.
- For fine adjustment tap the star and large flame or small flame. There is a separate OFF button.

Wall Switch/Touch Pad/Switch Panel  
(see figure 13)

- Press button "A" to increase flame height.
- Press button "C" to decrease flame height or set appliance at pilot flame.
- For fine adjustment tap the button "A" or "C".

**NOTE:** If the appliance will not operate, follow the instructions "TURN OFF GAS TO APPLIANCE".





### SETTING °C/24 HOUR OR °F/12 HOUR CLOCK

Display, Timer/Thermostat RF Remote Handsets  
(see figures 11, 12)

- Press OFF and  (small flame) until display changes from Fahrenheit/12 hour clock to Celsius/24 hour clock and vice versa.

### SETTING THE TIME

Display, Timer/Thermostat RF Remote Handsets  
(see figures 11, 12)



- The display will flash after either:
  - a. Installing the battery or
  - b. Simultaneously pressing the  (large flame) and  (small flame).
- Press  (large flame) to set the hour and the  (small flame) to set the minute.
- Press OFF to return to manual mode or simply wait and it will automatically return to the manual mode.

Remaining Instructions pertain to Timer/Thermostat RF Remote Handset only (see figure 12)



### CHANGING THE MODE OF OPERATION

Briefly pressing the SET button changes the mode of operation in the following order:

 →  →  →  → and back to 

**NOTE:** MANUAL mode can also be reached by pressing either the  (large flame) or the  (small flame).

### Mode - Manual Flame Height Adjustment

- Press  (large flame) to turn on the main burner.
- Press  (large flame) to increase the flame height.
- Press  (small flame) to decrease the flame height or to go to pilot standby position.

**NOTE:** While pressing either button a symbol indicating transmission appears on the display. The receiver confirms transmission with an acoustic signal.



### - Daytime Temperature Mode

(appliance must be in standby mode; pilot ignited):  
The room temperature is measured and compared to the set temperature. The flame height is then automatically adjusted to achieve the Daytime set temperature.



### - Nighttime Setback Temperature Mode

(appliance must be in standby mode; pilot ignited):  
The room temperature is measured and compared to the Nighttime Setback temperature. The flame height is then automatically adjusted to achieve the Nighttime Setback temperature.

### - Timer Mode

(appliance must be in standby mode; pilot ignited):  
The Timer setting allows you to set two (2) burner  times and two (2) burner  times every 24 hours.





For  to operate as a thermostat, TEMP must be set at 40°F (4°C) or higher.

If the  setting is decreased to --, the motor will turn the valve to the standby position in the moon times and await the next burner  cycle.







# MERTIK – TROUBLESHOOTING

## OPERATING INSTRUCTIONS

### SETTING THE TEMPERATURE

- Select either the  **TEMP** MODE or the  **TEMP** MODE by briefly pressing the SET button.
- Hold the SET button until the TEMP display flashes.
- Set the desired temperature with  (large flame) or  (small flame).
- Press OFF or simply wait to complete programming.

### SETTING THE TIMER



- Select Timer mode by briefly pressing the SET button.
- Press and hold the SET button until the P1  (sun symbol is displayed) and the time flashes. Set the hour by pressing the  (large flame) and set the minutes by pressing the  (small flame).
- Briefly press SET button for the next burner cycle time.
- Example: P1  (moon symbol) continue through P2  (sun symbol) and P2  (moon symbol).
- Once all four (4) times are set, press OFF or simply wait to complete programming.

### MANUAL OPERATION (see figures 15, 16, pg. 5)

(Only possible, when MANUAL knob is used)

Follow appliance manufacturer's instructions for gaining access to the gas control and the pilot burner. Access to the pilot burner is only required for ignition with a match.

When turning main valve knob, do not force. Knob has a slip clutch that clicks until the end stops are reached. This allows for manual flame height adjustment as well as adjustment to pilot standby position.

1. **STOP!** Read the safety information included before proceeding.
2. Turn main valve knob to the OFF, full clockwise  position.
3. Turn MANUAL knob to the MAN, full clockwise  position.
4. Place ON/OFF switch (if equipped) in O (OFF position).
5. Wait five (5) minutes to clear out any gas. Verify that no gas is in the area around the appliance, including near the floor. **If you detect gas STOP!** Follow "A" in the safety information on page 1. If no gas is present, proceed to step 6.
6. Place ON/OFF switch (if equipped) in I (ON position).
7. With the MANUAL knob in MAN position a manual pilot valve operator and piezo igniter (optional) are accessible.
8. Fully push down manual pilot valve operator and hold in, to start pilot gas flow (see figure 15).



#### Ignition with match:

Immediately light the pilot with a match, while continuing to hold in the manual pilot valve operator for about one (1) minute after the pilot is lit. Release manual pilot valve operator. If pilot does not stay lit, wait five (5) minutes and repeat.

#### Ignition with piezo igniter:

Change the ignition cable from the receiver to the valve (see figures 15 and 17). Use the push piezo igniter to ignite. If pilot does not stay lit, wait five (5) minutes and repeat.

**NOTE:** If the pilot does not stay lit after several tries, turn the gas control knob (main valve knob) to OFF and proceed to step 11.

9. If applicable, per appliance manufacturer's instructions, replace pilot access panel before proceeding.
10. Turn MANUAL knob to the ON, full counterclockwise  position.
11. Turn main valve knob to the full ON, full counterclockwise  position.
12. If the appliance will not operate, follow the instructions "TURN OFF GAS TO APPLIANCE" and call the service technician or gas supplier.

### TURN OFF GAS TO APPLIANCE

- Press OFF button on remote or wall switch/touch pad/switch panel.
- Follow appliance manufacturer's instructions for gaining accessibility to the gas control.
- Place ON/OFF switch (if equipped) in O (off position).
- Turn main valve knob to the OFF full clockwise  position.
- Replace appliance accessibility cover (if applicable), per appliance manufacturer's instructions.

# MERTIK – TROUBLESHOOTING

## OPERATING INSTRUCTIONS

### MISCELLANEOUS

#### Low Battery Indication

Receiver:  
three short beeps will sound when motor turns

Standard/Infrared remote:  
the red LED will get darker

Remote with display:  
"BATT" will appear on display

**NOTE:** Pertains to Thermostatic Displays/Handsets:  
If the battery of the handset is low or if the transmitter is out of the communication range, the motor turns down the valve to pilot gas after 6 hours.

**NOTE:** With very low battery the GV80 system shuts off the fire completely. This will not happen if the power supply is interrupted.

#### Battery replacement

Battery replacement is recommended at the beginning of each heating season. Pull ribbon to remove batteries. Do not use metal tools to remove batteries. Using a metal tool could cause a short that may damage the receiver.

#### Location of Receiver

When the RF-receiver is placed in the appliance, the surrounding metal can reduce reception considerably. The position of the antenna on the receiver also influences reception. It is recommended to straighten the antenna. The antenna must not come in contact or cross the ignition wire, this may render the receiver inoperable.

**NOTE:** To keep receiver free from debris, dirt, and humidity, do not remove the receiver from the plastic bag until all construction is complete.

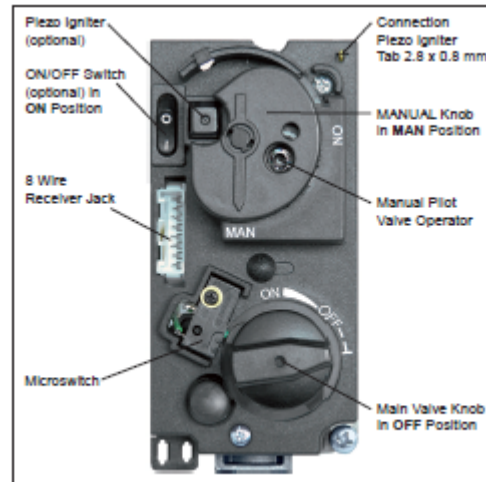

Figure 15: Combination Control, Cover

SEE APPENDIX 1

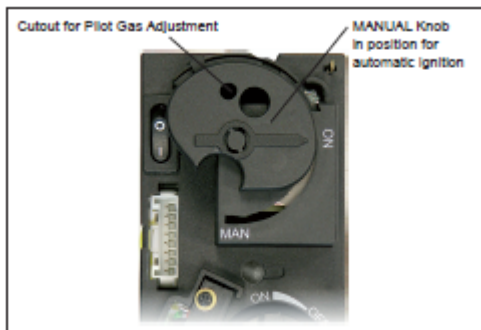

Figure 16: Combination Control, View MANUAL knob

# MERTIK – TROUBLESHOOTING

## RE-SETTING THE CONTROL BOX

1 ACCESS THE CONTROL BOX  
(SEE SERVICING INSTRUCTIONS)



2 REMOVE THE BATTERY POWER  
PACK LEAD FROM THE CONTROL BOX



3 FIND THE RESET BUTTON ON THE  
SIDE OF THE CONTROL BOX



4 KEEP DEPRESSING THE RESET BUTTON  
UNTIL NO SOUND CAN BE HEARD



5 PLUG BACK THE POWER LEAD TO  
THE CONTROL BOX



7 THE CONTROL BOX IS NOW RESET  
TO FACTORY SETTINGS



# MERTIK – TROUBLESHOOTING

## RE-PAIRING THE HANDSET

1

ACCESS THE CONTROL BOX  
(SEE SERVICING INSTRUCTIONS)



2

WITH THE POWER STILL CONNECTED  
PRESS THE RESET BUTTON ON THE  
CONTROL BOX UNTIL YOU HEAR TWO  
SIGNALS AFTER THE SECOND LONGER  
SIGNAL RELEASE THE RESET BUTTON

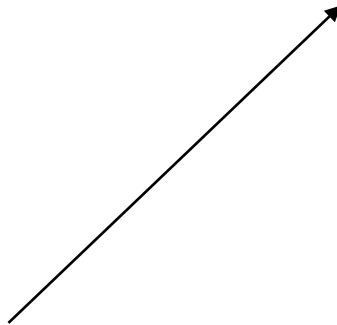

3

WITHIN 20 SECONDS PRESS THE DOWN  
ARROW ON THE HANDSET UNTIL YOU  
HEAR A " 2 BEEP" SIGNAL  
CONFIRMING THE NEW CODE

