

INSTRUCTION MANUAL

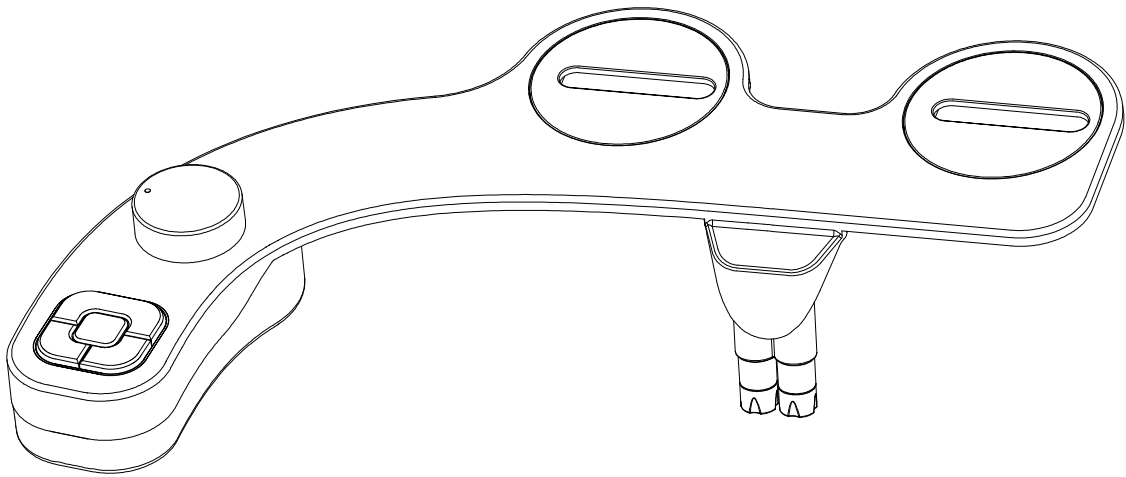

Names And Functions Of Parts

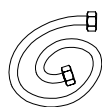
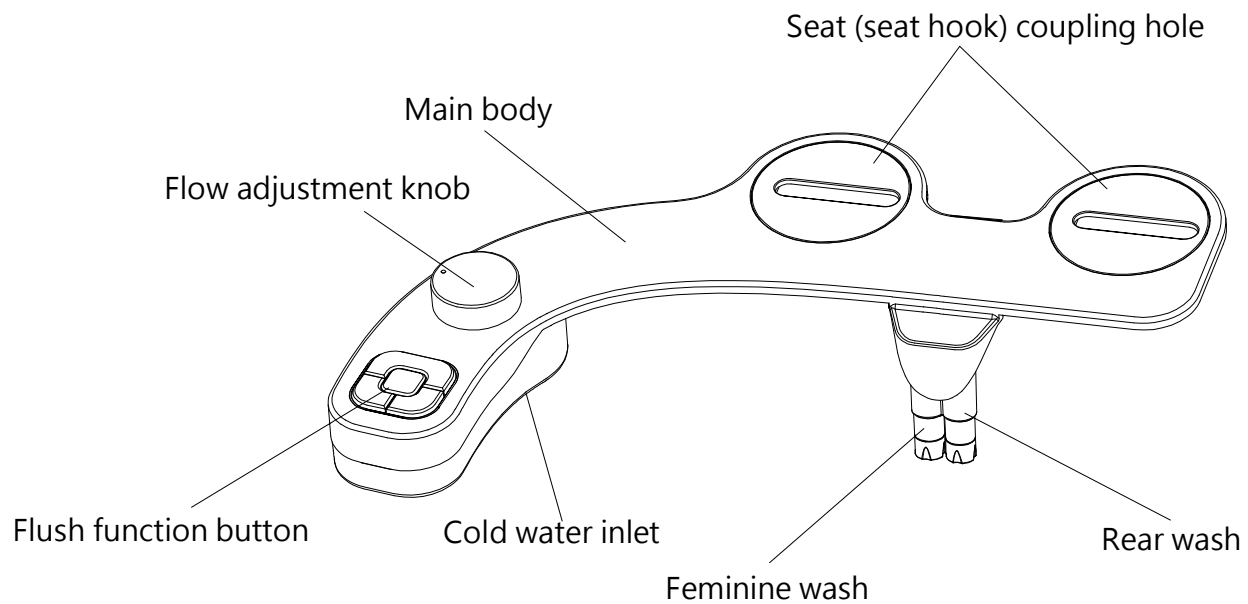

Tube



T-adaptor

Installation Tools Needed



Wrench



Screwdriver

Install The Bidet



a

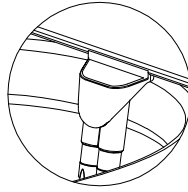

Adjust the nozzle position and try to make it close to the rim of the toilet.

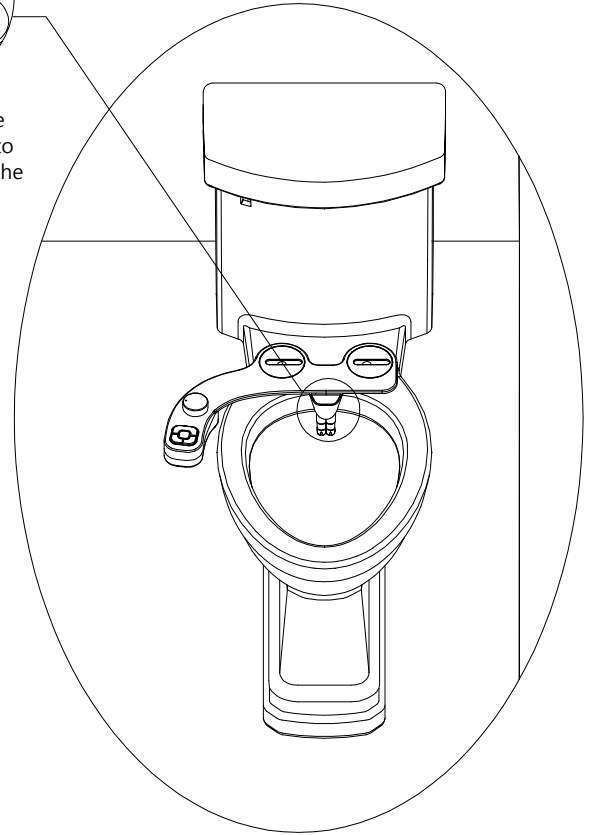

b

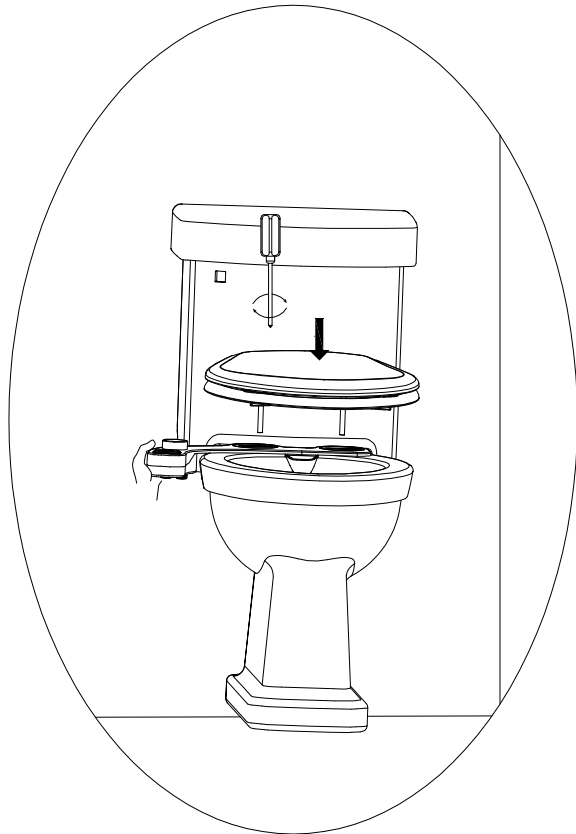

c

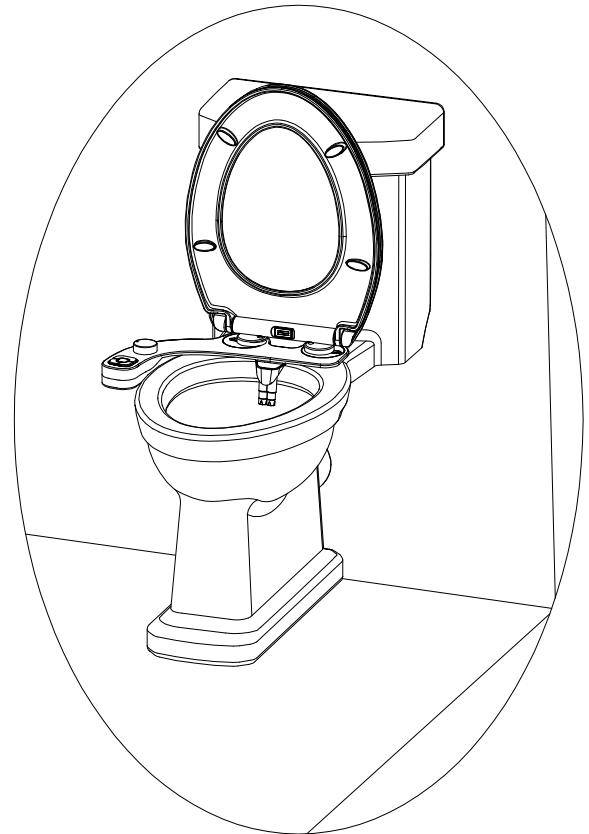

d

Connect Cold Water

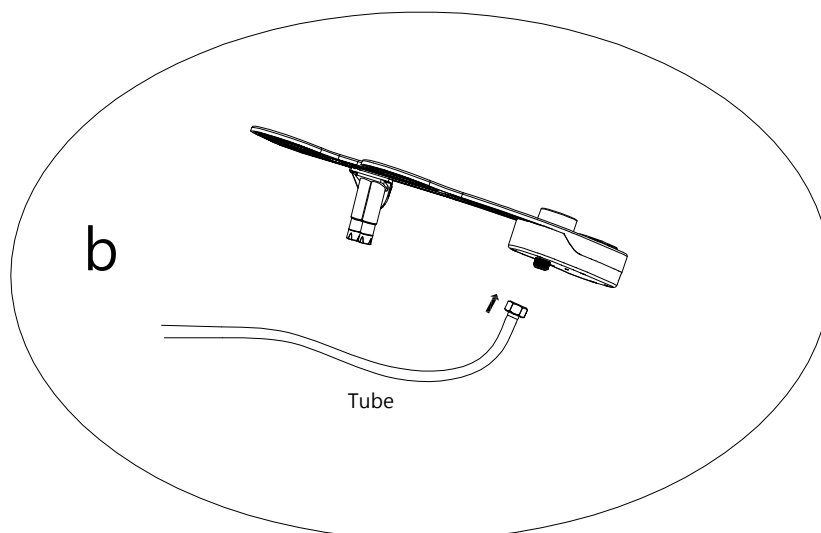
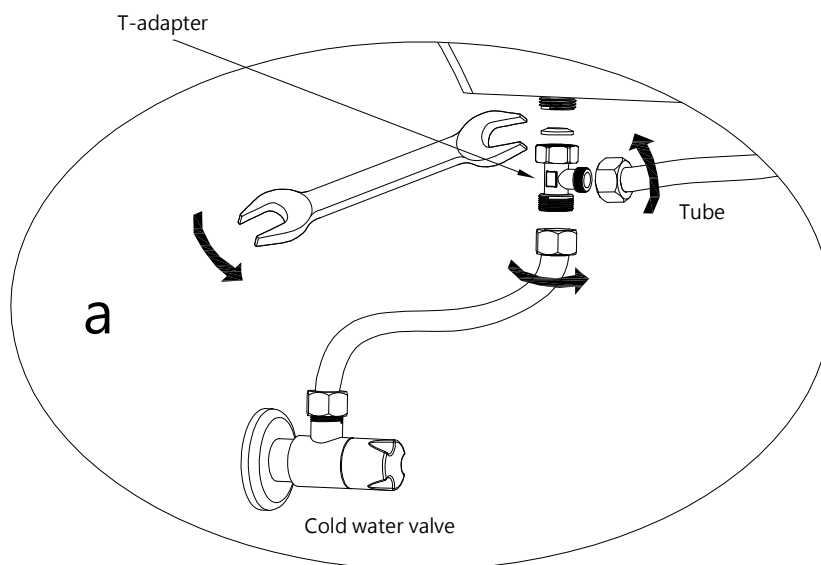
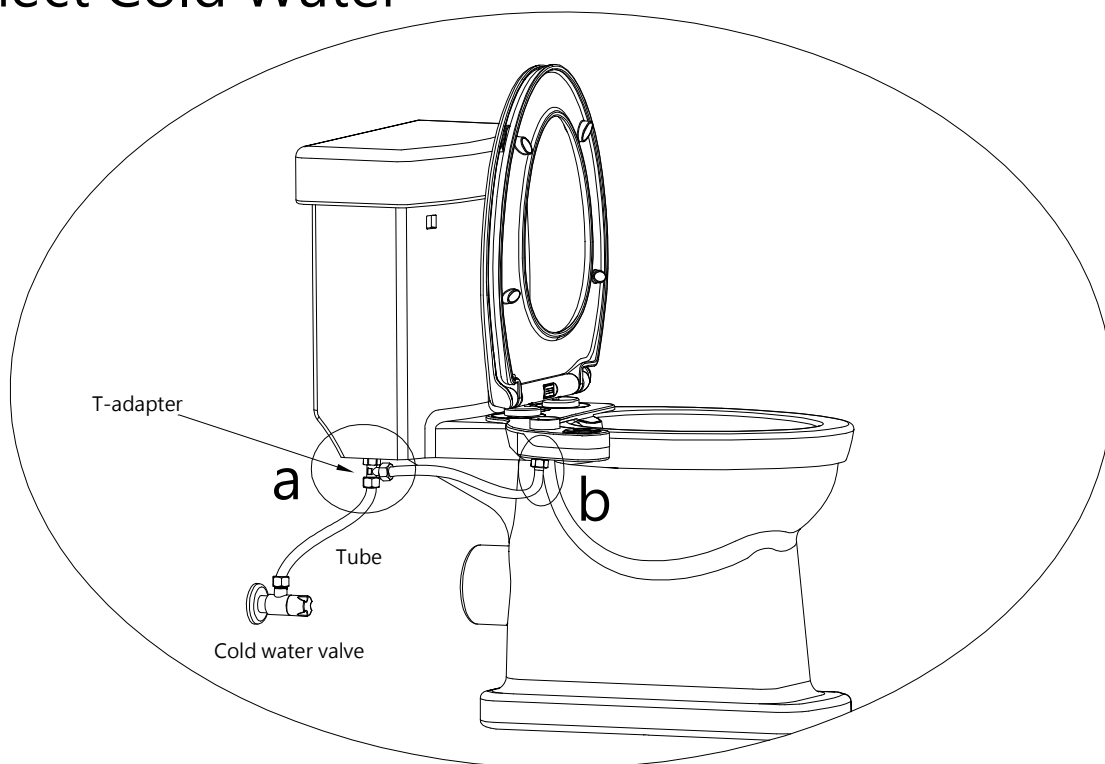

Operating Instructions

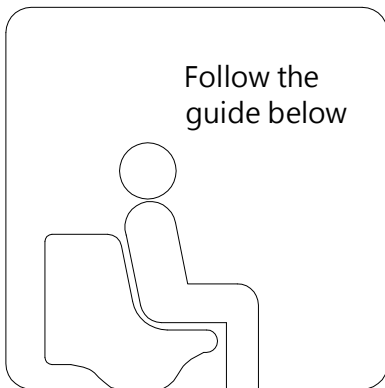

1. Select the nozzle function using the button.

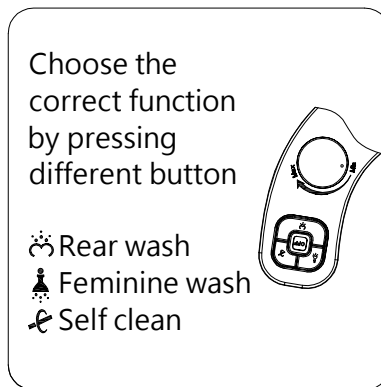
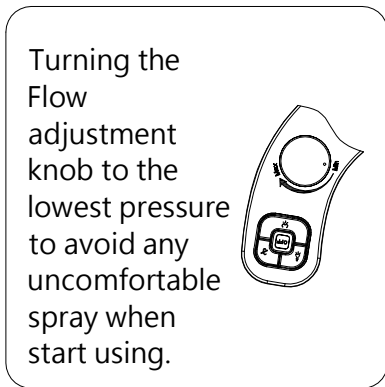

2. Adjust the water flow.

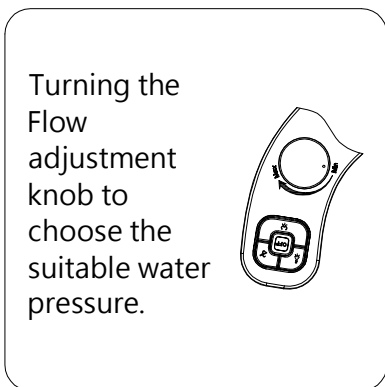

3. Use as long as needed.

