



HÅFSTRÖMS

# LARM & ÖVERVAKNING

Håfströms Service AB  
Smedstad 307  
665 91 Kil  
[www.hafstroms.se](http://www.hafstroms.se)  
Tel 054 12 00 80



**HIKVISION**

## Wireless Bridge

Quick Start Guide

# Contents

<b>Chapter 1 Introduction .....</b>	<b>1</b>
1.1 Interface/Button .....	1
1.2 SSID .....	2
1.3 Indicator .....	2
1.4 Packing List .....	3
<b>Chapter 2 Installation .....</b>	<b>5</b>
2.1 Preparations for Installation .....	5
2.2 Pole Mounting .....	5
2.3 Wall Mounting .....	7
2.4 Connection and Power On .....	8
2.4.1 AP Connection .....	9
2.4.2 CPE Connection .....	9
<b>Chapter 3 Activation and Login .....</b>	<b>11</b>
3.1 Activation Using Web Browser .....	11
3.2 Activation Using iVMS 4200 .....	11
<b>Chapter 4 Get More Information .....</b>	<b>12</b>

# Chapter 1 Introduction

The 5 GHz gigabit wireless bridge (hereinafter referred to as the device) is used for long-distance wireless connection, which is suited for outdoor video security and transmission between sites in a LAN. The device supports 16 SSIDs, point-to-point as well as point-to-multipoint transmission.

## 1.1 Interface/Button

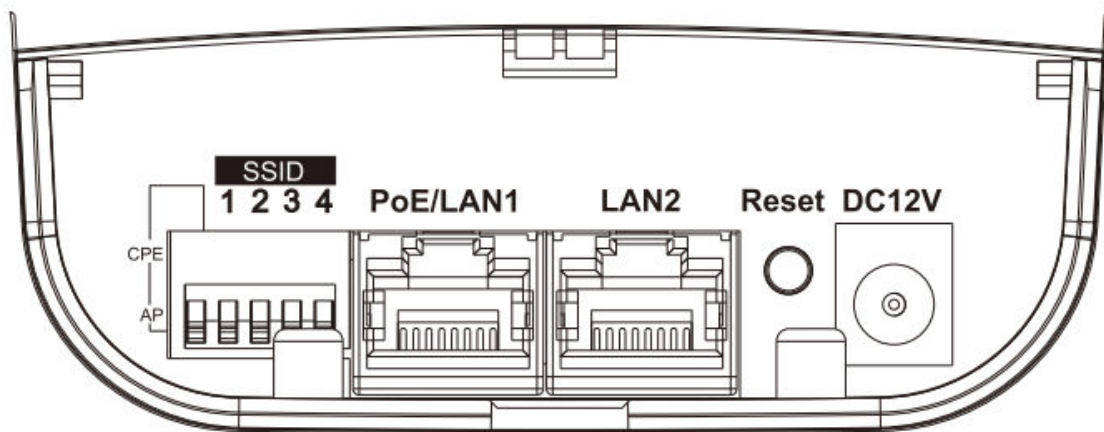

Figure 1-1 Interface/Button of Wireless Bridge

Table 1-1 Interface/Button Description

Interface/Button	Description
CPE/AP DIP Switch	Switch up or down to set the device as AP or CPE.
SSID	4-character SSID to realize 16 kinds of matching ways by switching up or down. The CPE will connect to the AP when its SSID matches the AP's.  <b>Note</b> The AP's SSID should be unique.
PoE/LAN 1	The 10/100/1000 Mbps adaptive RJ45 port, also can be used as a PoE port.
LAN 2	The 10/100/1000 Mbps adaptive RJ45 port.
Reset	Long press for 4 sec to restore to factory settings.
DC 12V	If the PoE injector is not used for powering on the device, you can use the attached power adapter to connect the device to socket.

## 1.2 SSID





4-character SSID can realize 16 kinds of matching ways by switching the DIP up or down.

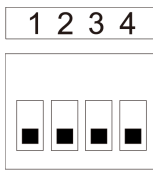
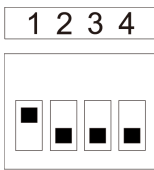
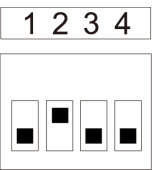
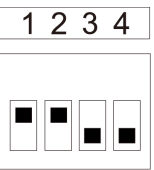
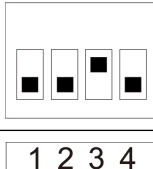
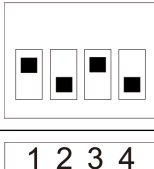
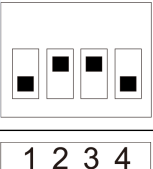
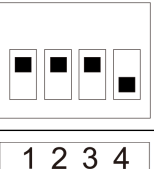
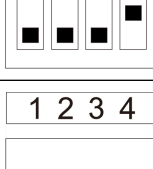
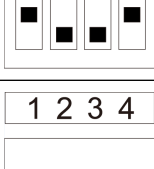
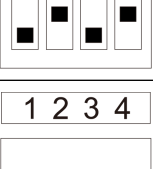
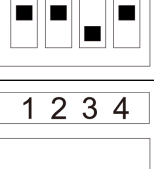

**Note**

Please switch the CPE/AP DIP to set what the device is used as before setting the SSID.

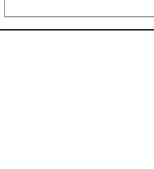
**Table 1-2 SSID No. Introduction**

No.	DIP	No.	DIP	No.	DIP	No.	DIP
1		2		3		4	
5		6		7		8	
9		10		11		12	
13		14		15		16	

## 1.3 Indicator

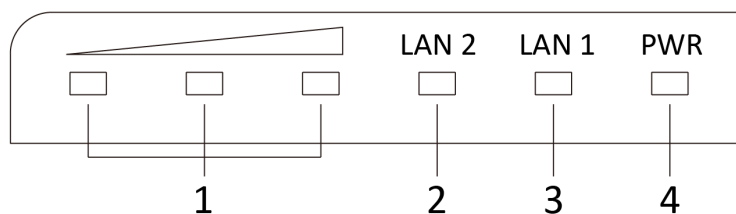

**Figure 1-2 Indicator**

**Table 1-3 Indicator Description**

No.	Indicator	Description	
1	Signal Strength Indicator	Solid	The devices are matched. <ul style="list-style-type: none"><li>• Solid red, yellow and green: <math>RSSI \geq -60</math>, the wireless signal is strong.</li><li>• Solid red and yellow, unlit green: <math>-75 \leq RSSI &lt; -60</math>, the wireless signal is normal.</li><li>• Solid red, unlit yellow and green: <math>RSSI &lt; -75</math>, the wireless signal is weak. Please adjust the position and direction of the device.</li></ul>
		Unlit	The devices are not matched.
2/3	LAN 1/LAN 2 Indicator	Solid Green	The port is connected.
		Flashing Green	The port is transmitting data. The faster the indicator flashes, the greater the transmission rate is.
		Unlit	The port is disconnected or connection is abnormal.
4	Power Indicator	Solid Green	The device is powered on normally.
		Unlit	No power supply connected or power supply is abnormal.

### 1.4 Packing List

Please check if there is any damage of the package first. According to the packing list, make sure no item is lost. After confirming, you can continue to install the device.

# Wireless Bridge Quick Start Guide

---

**Table 1-4 Packing List**

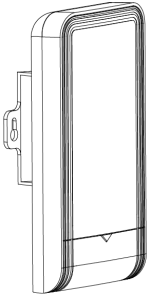
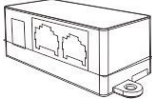
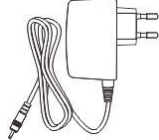
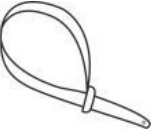
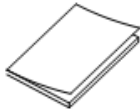
Item	Quantity	Item	Quantity	Item	Quantity
	Wireless Bridge × 1		PoE Injector × 1		Power Adapter × 1
	Cable Tie × 2		Quick Start Guide × 1	--	--

## Chapter 2 Installation

### 2.1 Preparations for Installation

To avoid device damage or personal injury caused by improper useage of the device, please follow the preparations below.

- Use the attached power adapter and PoE injector to power the device.
- The distance between AP and CPE should be less than the suggested figure to secure transmission rate.
- Make sure the device is installed vertically in forward direction, while not horizontally or in reverse direction.
- Make sure the water-proof cover is on.
- Protect the power adapter and PoE injector from rain. It is suggested to put them into a water-proof case or the dry place.
- It is suggested to manage the gap between cover and device with fluid dispensing.
- Install the device in the place where the maintenance personnel can operate.
- The devices should be installed face to face and the max. angle of deviation is 30° .
- Disconnect the power source during servicing.
- The temperature of the cover area will be high when device working. Only installation and maintenance personnel can operate.

### 2.2 Pole Mounting

#### Before You Start

Mount the device on the pole with a diameter of 40 to 100 mm using the attached cable tie.

#### Steps

1. Thread the cable ties into the installtion holes at the back of the device.

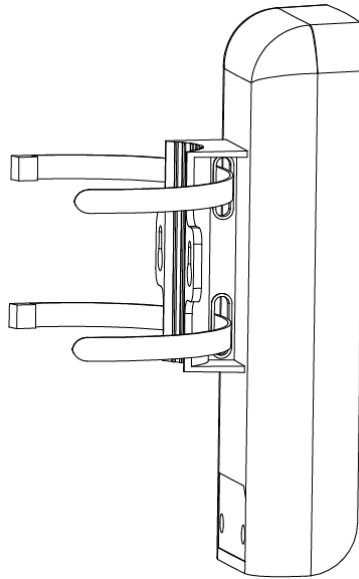

**Figure 2-1 Thread Cable Ties**

2. Fix and fasten the cable ties on the pole.

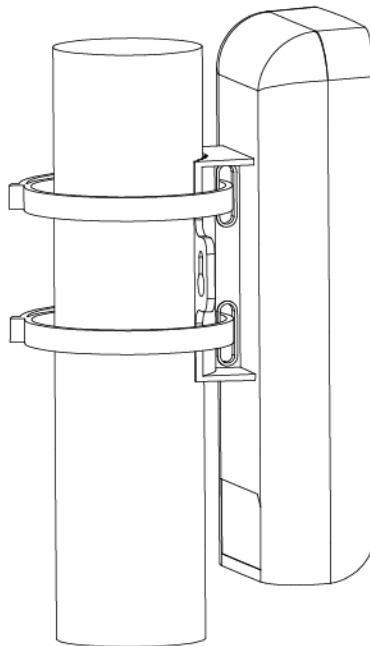

**Figure 2-2 Pole Mounting Finished**

---

 **Note**

Adjust the direction of the device manually to keep it vertical in forward direction.

---



## 2.3 Wall Mounting

Mount the device on a flat and stable wall with 2 M4 expansion bolts.

### Steps

---

#### Note

It is easy to take down the device for wall mounting. Please mount with caution.

---

1. Drill two parallel holes, about 54.5 mm apart.
2. Insert the bolts into the pre-drilled hole, leaving 5 mm length out of the wall.

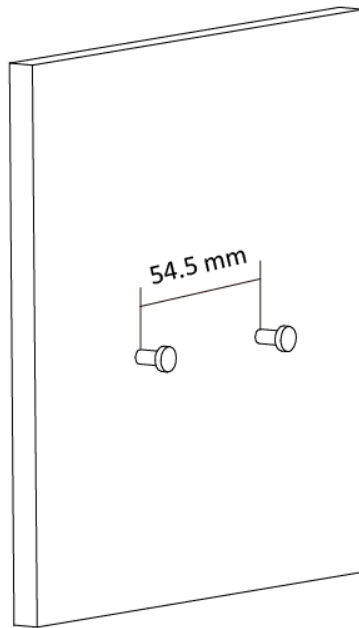

**Figure 2-3 Expansion Bolt Position**

3. Align the bigger round hole of the hanging hole with the bolts, and hang the device on the bolts.

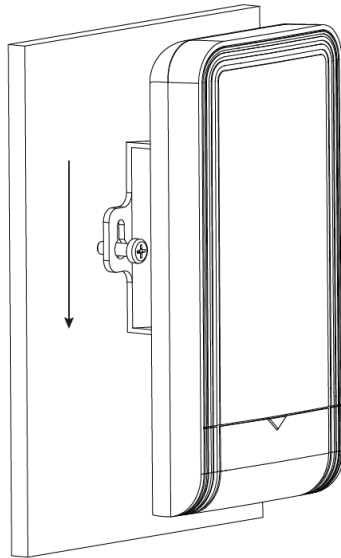

**Figure 2-4 Hang the Device**

4. Make sure the device is mounted stably and vertically in forward direction.

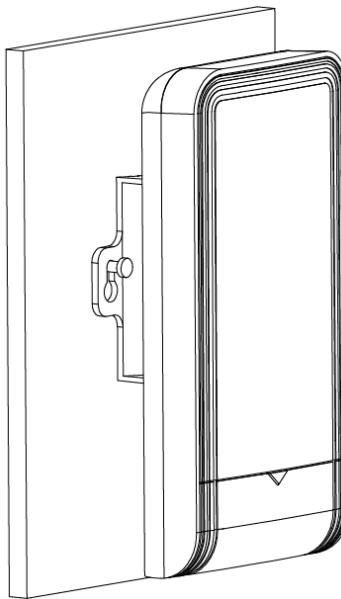

**Figure 2-5 Wall Mounting Finished**

## 2.4 Connection and Power On

Use the attached power adapter and PoE injector to power on the device.

## 2.4.1 AP Connection

### Steps

1. Switch the CPE/AP DIP to set the device as AP.
2. Select an SSID No.

### Example

SSID No. 1 (All Down).

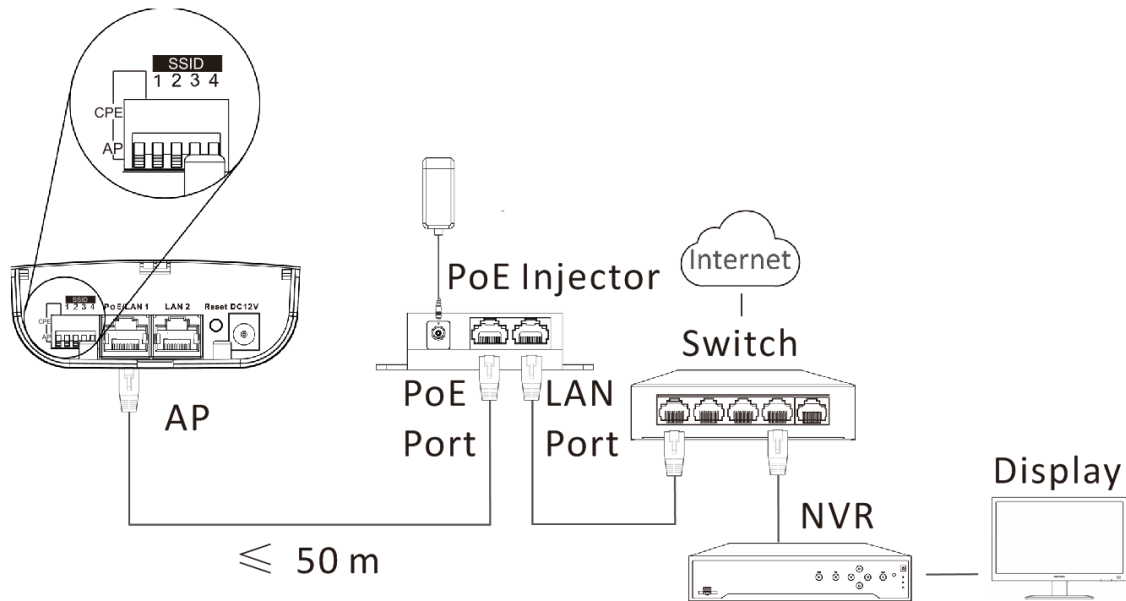

Figure 2-6 AP Connection



### Note

- See **Table 1-2** for detailed information about SSID No.
  - The PoE injector must be connected to an earthed mains socket-outlet.
- 

## 2.4.2 CPE Connection

### Steps

1. Switch the CPE/AP DIP to set the device as CPE.
2. Select the SSID No. set on the AP to match.

### Example

SSID No. 1 (All Down).

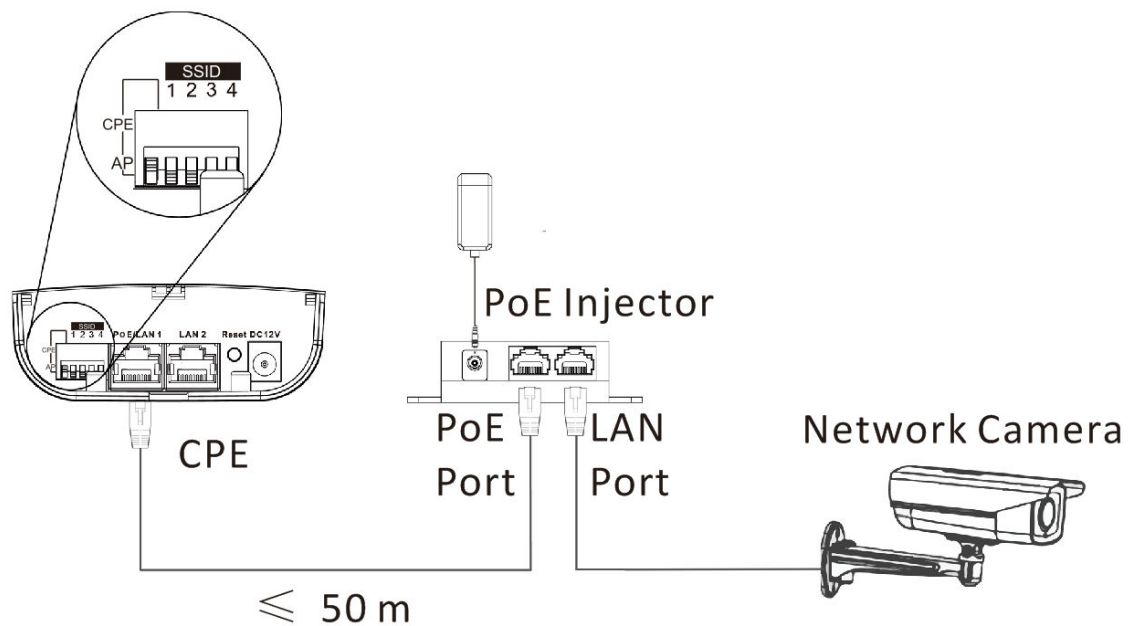

**Figure 2-7 CPE Connection**

**3. Optional:** If there are more than one CPE (no more than 4) to be matched with one AP, repeat the previous steps connect and set the CPEs.

### What to do next

#### Note

- See **Indicator** for details after connection to check device powering, network connection and signal strength.
  - The SSIDs of APs in the same direction cannot be the same to avoid matching failure.
  - The PoE injector must be connected to an earthed mains socket-outlet.
-

## Chapter 3 Activation and Login

You can manage the device using the iVMS 4200 software or the Web browser. Before managing the device, you need to activate and log in to the device first.

---

### Note

- Make sure the device is powered on and connected to the network correctly.
  - Make sure the device is in the same network segment with the PC.
- 

### Caution

The password strength of the device can be automatically checked. We highly recommend you change the password of your own choosing (using a minimum of 8 characters, including at least three kinds of following categories: upper case letters, lower case letters, numbers, and special characters) in order to increase the security of your product. And we recommend you change your password regularly, especially in the high security system, changing the password monthly or weekly can better protect your product.

Proper configuration of all passwords and other security settings is the responsibility of the installer and/or end-user.

---

### 3.1 Activation Using Web Browser

#### Steps

1. Enter **192.168.1.36** in the web browser.
2. Set **Password**.
3. Read and agree with the disclaimer and select **Country/Region Code**.
4. Click **OK** to finish activation.

### 3.2 Activation Using iVMS 4200

#### Steps

1. Download and install the latest iVMS 4200 software from the official website.
2. Select the inactive device and click **Activate** in **Online Device**.
3. Create a password in the password field, and confirm the password.
4. Click **OK** to activate the device.
5. Click **Add**, set **Name**, **IP Address** and **Password** to add the device to the client.
6. Read and agree with the disclaimer and select **Country/Region Code**.
7. Click **OK** to finish activation.