

Exclusively for



InverSmart

INVERTER POOL HEAT PUMP



USER MANUAL

Table of contents

A. Foreword	1
B. Safety precautions	2
1. Warning	2
2. Attention	3
3. Safety	3
C. About your heat pump	4
1. Transportation	4
2. Accessories	4
3. Features	4
4. Operating condition and range	5
5. Introduction of different modes	5
6. Technical parameter	6
7. Dimension	7
D. Installation guidance	8
1. Installation reminder	8
2. Wiring	9
3. Electric wiring diagram	10
4. References for protecting devices and cable specification	10
E. Operation guidance	11
1. Key function	11
F. Testing	14
1. Inspect heat pump before use	14
2. Leakage detection notice and method	14
3. Trial	14
G. Maintenance	15
H. Trouble shooting for common faults	16
I. Wi-Fi operation	18

A. Foreword

Thank you for choosing our inverter pool heat pump, which is designed for more silent and energy saving user experience. It is an ideal way for green pool heating.

We hope you'll enjoy using our heat pumps.

Thank you!

B. Safety precautions

We have provided important safety messages in this manual and on your heat pump. Please always read and obey all safety messages.

Environment friendly R32 Refrigerant is used for this heat pump

1. Warning



The WARNING sign denotes a hazard. It calls attention to a procedure, practice, or the like, which, if not correctly performed or adhered to, could result in personal injury or injury to a third party. These signs are rare, but are extremely important.

	a. Keep the heat pump away from fire source.
	b. It must be placed in well ventilated area, indoor or closed area is not allowed.
	c. Repair and disposal must be carried out by trained service personnel
	d. Vacuumize completely before welding. Welding can only be carried out by professional personnel in service center.

2. Attention

- a. Please read the following instructions before installation, use and maintenance.
- b. Installation must be done by professional staff only in accordance with this manual.
- c. A leakage test must be performed after installation.
- d. Please don't stack substances, which will block air flow near inlet or outlet area, otherwise the efficiency of the heat pump will be reduced or even stopped.
- e. Set proper temperature in order to get comfortable water temperature to avoid overheating or overcooling.
- f. In order to optimize the heating effect, please install heat preservation insulation on pipes between swimming pool and the heat pump, and please use a recommended cover on the swimming pool.
- g. Connecting pipes of the swimming pool and the heat pump should be $\leq 10\text{m}$.
- h. Except for the methods recommended by the manufacturer, do not use any methods to accelerate the defrosting process or clean the frosted parts.
- i. If a repair is required, please contact the nearest after-sales service center. The repair process must be strictly in accordance with manual. All repair practice by non-professional is prohibited.
- j. Don't use or stock combustible gas or liquid such as thinners, paint and fuel to avoid fire.

3. Safety

- a. Please keep the main power supply switch far away from the children.
- b. When a power cut happens during operating, and later the power is restored, the heat pump will start up.
- c. Please switch off the main power supply in lightening and storm weather to prevent from machine damage that caused by lightning.
- d. Safety inspection must be carried before the maintenance or repair for heat pumps with R32 gas in order to minimize the risk.
- e. Installation and any repairing should be conducted in the area with good ventilation. The ignition source is prohibited during the operation.
- f. If R32 gas leaks during the installation process, all operations must be stopped immediately and call the service center.

C. About your heat pump

1. Transportation

- a. Always keep upright

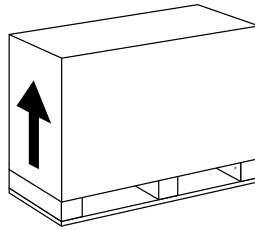

- b. Do not lift the water union
(Otherwise the titanium heat exchanger inside the heat pump may be damaged)

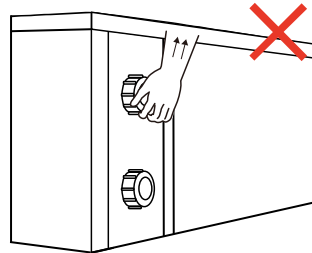

2. Accessories

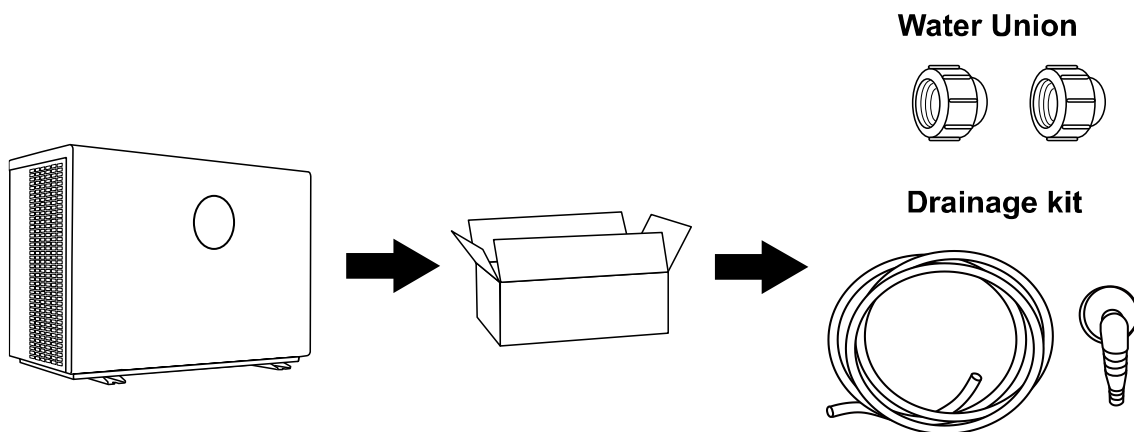

3. Features

- DC Twin-rotary inverter compressor of Mitsubishi
- DC Brushless fan motor
- EEV Technology
- Reverse cycle defrosting with 4-way valve
- High-efficiency twisted titanium heat exchanger
- Sensitive and accurate temp control and water temp display
- High pressure and low-pressure protection
- Full protection on electrical system



4. Operating condition and range

To provide you comfort and pleasure, please set swimming pool water temperature efficiently and economically.

The heat pump can work between air $-5^{\circ}\text{C}\sim 43^{\circ}\text{C}$, and its ideal operation range is between air $15^{\circ}\text{C} \sim 25^{\circ}\text{C}$.

5. Introduction of different modes

- a. The heat pump has two modes: Boost and Silence.
- b. They have different strengths under different conditions.

Mode	Modes	Strength
	Boost mode	Heating capacity: 20% to 100% capacity Intelligent optimization Fast heating
	Silence mode	Heating capacity: 20% to 80% capacity Sound level: 3dB (A) lower than Boost mode

6. Technical parameter

Model	IST09	IST13	IST16
PERFORMANCE CONDITION: Air 27°C/ Water 27°C/ Humid. 80%			
Heating capacity (kW)	9.0	12.6	16.1
COP Range	14~6.5	14~6.4	15~6.5
Average COP at 50% Speed	9.0	9.5	9.6
PERFORMANCE CONDITION: Air 15°C/ Water 26°C/ Humid. 70%			
Heating capacity (kW)	6.5	9.0	11.0
COP Range	6.8~4.5	7~4.4	7~4.5
Average COP at 50% Speed	6.2	6.3	6.3
TECHNICAL SPECIFICATIONS			
Advised pool volume (m ³) *	20~50	30~60	40~75
Operating air temperature (°C)	-5°C~43°C		
Power supply	230V 1Ph		
Rated input power (kW)	0.24~1.45	0.32~2.10	0.39~2.5
Rated input current (A)	1.05~6.4	1.4~9.0	1.7~10.7
Sound level at 10m dB (A)	19~28.4	22.2~30.8	21.2~34.4
Advised water flux(m ³ /h)	2~4	4~6	6~8
Water connection (mm)	50		

Remarks:

This heat pump is able to perform normal within air temp -5°C~+43°C, efficiency will not be guaranteed out of this range. Please take into consideration that the pool heat pump performance and parameters are different under various conditions.

Related parameters are subject to adjustment periodically for technical improvement without further notice. For details please refer to nameplate.

7. Dimension

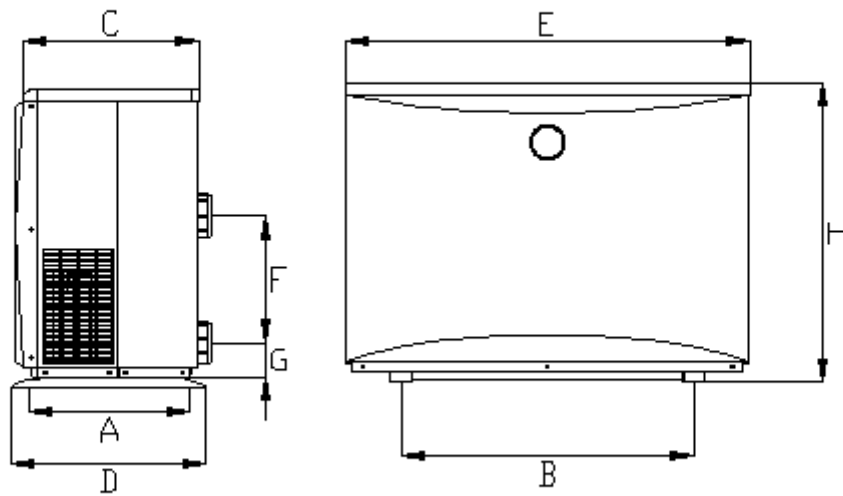

Size (mm) Name Model	A	B	C	D	E	F	G	H
IST09	410	645	387	430	890	250	75	657
IST13	410	645	387	430	890	290	75	657
IST16	410	645	387	430	890	280	75	657

※ Above data is subject to modification without notice.

Note: The picture above is the specification diagram of the pool heat pump, for technician's installation and layout reference only. The product is subject to adjustment periodically for improvement without further notice.

D. Installation guidance

1. Installation reminder

Only a professional staff is allowed to install the heat pump. The users are not qualified to install by themselves, otherwise the heat pump might be damaged and risky for users' safety.

a. Location and water pipe connection

 The inverter pool heat pump should be installed in a good ventilation place.

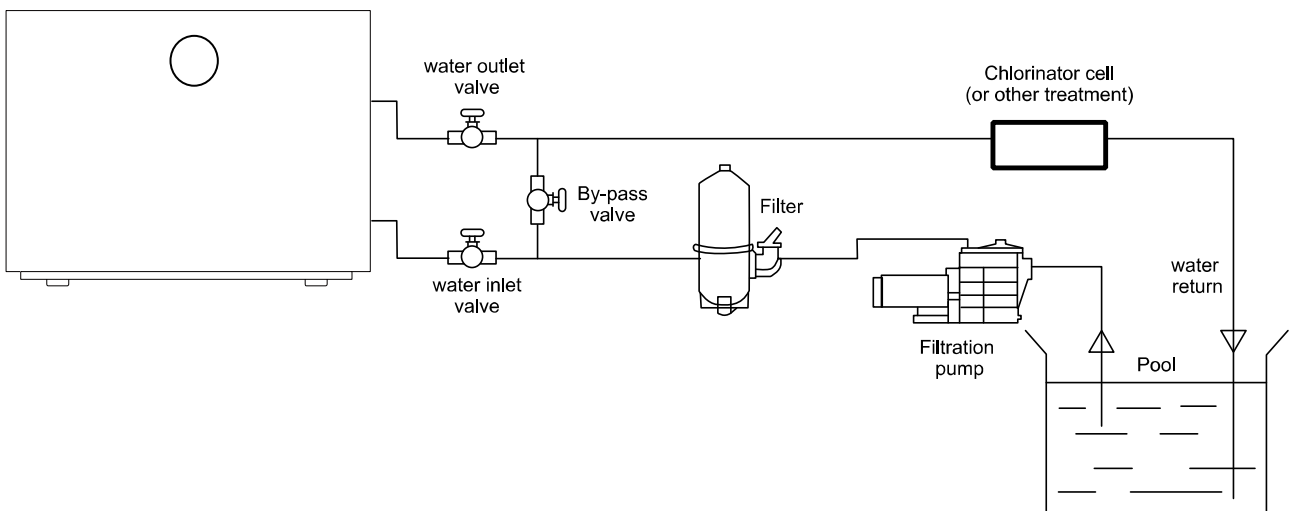
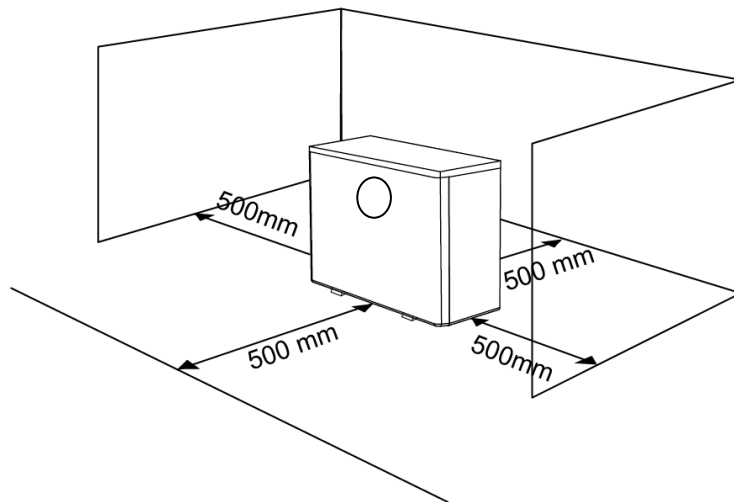

- 1) The frame must be fixed by bolts (M10) to concrete foundation or brackets. The concrete foundation must be solid and fastened; the bracket must be strong enough and antirust treated;
- 2) Please don't stack substances that will block air flow near inlet or outlet area, and there is no barrier within 50cm behind the main machine, or the efficiency of the heat pump will be reduced or even stopped;

- 3) The machine needs an appended pump (Supplied by the user). The recommended pump specification-flux: refer to Technical Parameter, Max. lift $\geq 10\text{m}$;
 - 4) When the machine is running, there will be condensation water discharged from the bottom, please pay attention to it. Please hold the drainage nozzle (accessory) into the hole and clip it well, and then connect a pipe to drain the condensation water out.
- b. The inlet and outlet water unions can't stand the weight of soft pipes. The heat pump must be connected with hard pipes!

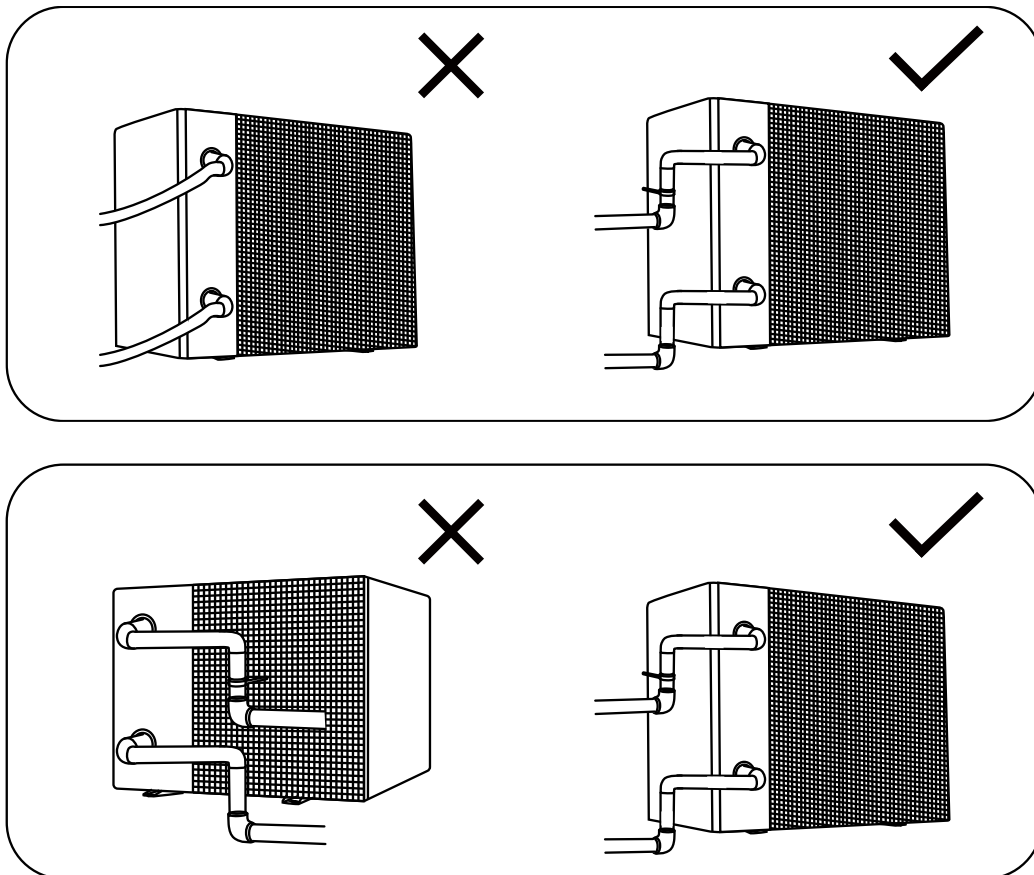

2. Wiring

- a. Connect to appropriate power supply, the voltage should comply with the rated voltage of the products.
- b. Earth the machine well.
- c. Wiring must be handled by a professional technician according to the circuit diagram.
- d. Set leakage protector according to the local code for wiring (leakage operating current $\leq 30\text{mA}$).
- e. The layout of power cable and signal cable should be orderly and not affecting each other.

3. Electric wiring diagram

For power supply: 230V 50Hz

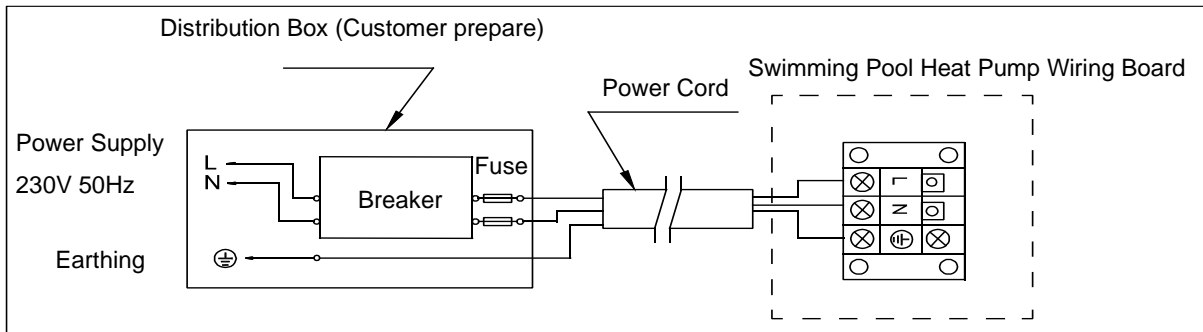

Note:

- 1)  must be hard wired, plug is not allowed.
- 2) The swimming pool heat pump must be earthed well.

4. References for protecting devices and cable specification

MODEL		IST09	IST13	IST16
Breaker	Rated Current (A)	10.5	13	18
	Rated Residual Action Current (mA)	30	30	30
Fuse (A)		10.5	13	18
Power Cord (mm ²)		3x2.5	3x2.5	3x2.5
Signal Cable (mm ²)		3x0.5	3x0.5	3x0.5







※ Above data is subject to modification without notice.

Note: The above data is adapted to power cord ≤ 10m. If power cord is > 10m, wire diameter must be increased. The signal cable can be extended to 50m maximally.



E. Operation guidance

1. Key function



Symbol	Heating only models
	<ol style="list-style-type: none"> 1. Power On/Off 2. Wi-Fi setting
	Lock/Unlock screen
	<ol style="list-style-type: none"> 1. Boost  2. Silence 
	Temperature Setting

2. Temperature display

Press  and  together for 5 second to switch temperature display.

a. Celsius display:

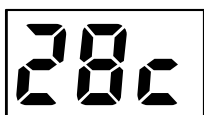

means 28°C

b. Fahrenheit display (only the temperature number):





means 104°F

3. Operation instruction

a. Screen Lock

- 1) Press " for 3 seconds to lock or unlock the screen
- 2) Automatic Lock Period: 30 seconds if no operation



b. Power On

Press " for 3 seconds to unlock screen. Press " to power on the device.

c. Temperature Setting

When the device is on, press " and " to set temperature. Press for more than 0.5 second for fast adjusting.





d. Boost/Silence Mode

Press " to switch among Boost mode ", Silence mode ".

Default mode: Boost mode "

Please choose Boost mode "

e. Defrosting





- 1) Automatic Defrosting: When the device is auto defrosting, " will flash, and return to previous working mode when it finished.
- 2) Manual Defrosting: Before entering manual defrosting mode, the compressor must be working for over 10 minutes. In heating mode, press both " and " for 5 seconds to start manual defrosting, " will flash when defrosting, until the defrosting finished, " will disappear.

(Remarks: the interval between two manual defrosting should be more than 30 minutes.)

f. Wi-Fi Setting

Please refer to "*I. Wi-Fi operation*"

g. Running Status Checking

1. Press " for 5 seconds, it will enter running status checking.
2. During this time, the screen will display the status symbol "CO" and its corresponding value.
3. Change status through " and ", the corresponding value will also change.
4. Press " to quit "Running Status Checking" mode

5. Running status checking table:

Symbol	Content	Unit
C0	Inlet water temp	°C
C1	Outlet water temp	°C
C2	Ambient temp	°C
C3	Exhaust gas temp	°C
C4	Evaporator coil pipe temp	°C
C5	Return gas temp	°C
C6	Cooling coil pipe temp	°C
C9	Cooling plate temp	°C
C10	EEV opening angle	P

F. Testing

1. Inspect heat pump before use

- a. The ventilating device and outlets are operating adequately and are not obstructed.
- b. It's prohibited to install refrigeration pipe or components in corrosive environment.
- c. Inspect the electric wiring on basis of the electric wiring diagram and earthing connection.
- d. Double confirm the main machine power switch should be off.
- e. Inspect the air inlet and outlet.

2. Leakage detection notice and method



- a. Leakage checking is prohibited in closed area.
- b. The ignition source is prohibited during the leakage inspection. A halide torch (or any other detector using a naked flame) shall not be used.
- c. Leakage detection fluids can be applied with most refrigerants but the use of detergents containing chlorine shall be avoided as the chlorine may react with the refrigerant and corrode the copper pipe.
- d. Vacuumize completely before welding. Welding can only be carried out by professional personnel in service center.
- e. Please stop using while gas leakage occur, and contact professional personnel in service center.

3. Trial

- a. The user must "Start the Pump before the Machine, and Turn off the Machine before the Pump", or the machine will be damaged.
- b. Before start the heat pump, please check for any leakage of water; and set suitable temperature in the thermostat, and then switch on power supply.
- c. In order to protect the swimming pool heat pump, the machine is equipped with a time lag starting function, the fan will run 1 minute earlier than the compressor when starting the machine, and it will stop running 1 minute later than the compressor when power off the machine.
- d. After the swimming pool heat pump start up, please kindly checking for any abnormal noise from the machine.

G. Maintenance



“CUT OFF” power supply of the heat pump before cleaning, examination and repairing

1. In winter season when you don't swim:
 - a. Cut off power supply to prevent any machine damage.
 - b. Drain water clear of the machine.

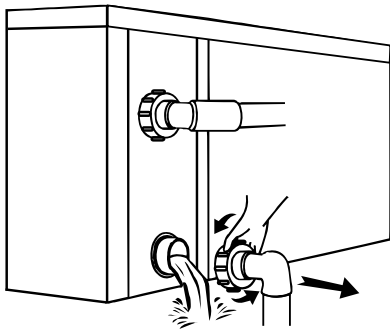

!!!Important:

Unscrew the water nozzle of inlet pipe to let the water flow out.
When the water in machine freezes in winter season, the titanium heat exchanger may be damaged.

- c. Cover the machine body when not in use.
2. Please clean this machine with household detergents or clean water, NEVER use gasoline, thinners or any similar fuel.
3. Check bolts, cables and connections regularly.
4. If repair or scrap is required, please contact authorized service center nearby.
5. Do not attempt to work on the equipment by yourself. Improper operation may cause danger.
6. In case of risking, safety inspection must be carried before the maintenance or repairing for heat pumps with R32 gas.

H. Trouble shooting for common faults

1. Repairing Guidance



WARNING:

- a. If repair or scrap is required, please contact authorized service center nearby.
- b. Requirements for Service Personnel
- c. Any person who is involved with working on or breaking into a refrigerant circuit should hold a current valid certificate from an industry-accredited assessment authority, which authorizes their competence to handle refrigerants safely in accordance with an industry recognized assessment specification.
- d. Do not attempt to work on the equipment by yourself. Improper operation may cause danger.
- e. Strictly comply with the manufacturer's requirements when charging R32 gas and equipment maintenance. This chapter focuses on special maintenance requirements for swimming pool heat pump with R32 gas. Please refer to the technical service manual for detailed maintenance operation.
- f. Vacuumize completely before welding. Welding can only be carried out by professional personnel in service center.

2. Failure solution and code

Failure	Reason	Solution
Heat pump doesn't run	No power	Wait until the power recovers
	Power switch is off	Switch on the power
	Fuse burned	Check and change the fuse
	The breaker is off	Check and turn on the breaker
Fan running but with insufficient heating	evaporator blocked	Remove the obstacles
	Air outlet blocked	Remove the obstacles
	3 minutes start delay	Wait patiently
Display normal, but no heating	Set temp. too low	Set proper heating temp.
	3 minutes start delay	Wait patiently
If above solutions don't work, please contact your installer with detailed information and your model number. Don't try to repair it yourself.		

Note: If the following conditions happen, please stop the machine immediately, and cut off the power supply immediately, then contact your dealer:

1. Inaccurate switch action.
2. The fuse is frequently broken or leakage circuit breaker jumped.

Protection & Failure code

NO.	Display	Protection code description
1	E3	No water protection
2	E5	Power supply exceeds operation range (not failure)
3	E6	Excessive temp difference between inlet and outlet water(Insufficient water flow protection)
4	Eb	Ambient temperature too high or too low protection (not failure)
5	Ed	Anti-freezing reminder (not failure)
NO.	Display	Failure code description
1	E1	High pressure protection
2	E2	Low pressure protection
3	E4	3 phase sequence protection (three phase only)
4	E7	Water outlet temp too high or too low protection
5	E8	High exhaust temp protection
6	EA	Heat exchanger overheat protection/Evaporator overheat protection (only at cooling mode)
7	P0	Controller communication failure
8	P1	Water inlet temp sensor failure
9	P2	Water outlet temp sensor failure
10	P3	Gas exhaust temp sensor failure
11	P4	Evaporator coil pipe temp sensor failure
12	P5	Gas return temp sensor failure
13	P6	Cooling coil pipe temp sensor failure
14	P7	Ambient temp sensor failure
15	P8	Cooling plate temp. sensor failure
16	P9	Current sensor failure
17	PA	Restart memory failure
18	F1	Compressor driver module failure
19	F2	PFC module failure
20	F3	Compressor start failure
21	F4	Compressor running failure
22	F5	Inverter board over current protection
23	F6	Inverter board overheat protection
24	F7	Current protection
25	F8	Cooling plate overheat protection
26	F9	Fan motor failure
27	Fb	Power filter plate No-power protection
28	FA	PFC module over current protection

I. Wi-Fi operation

1 APP Download



Android please download from



iOS please download from



2 Account Registration

1. Register by mobile or E-mail.

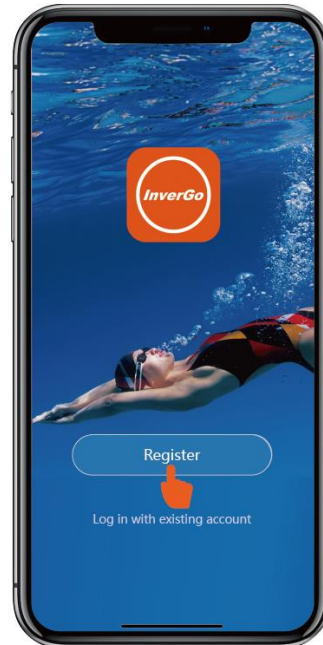

2. Mobile or E-mail registration.

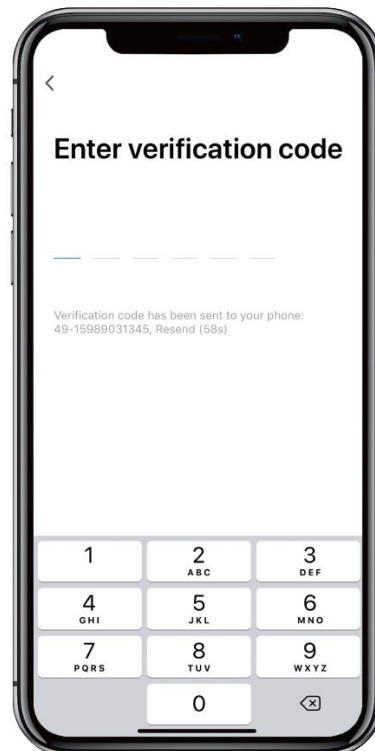
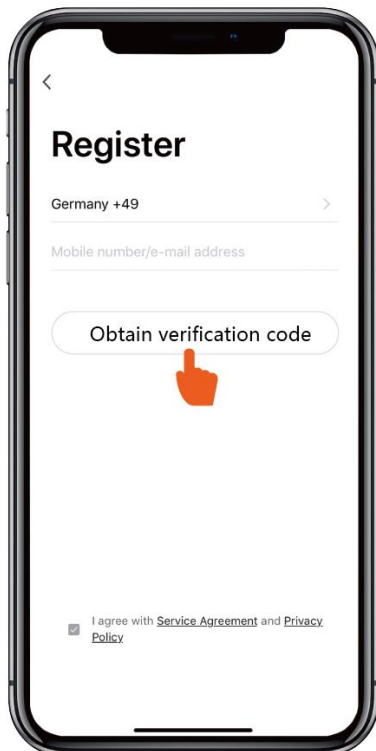

3 Create Family

Please set family name and choose the room of device.

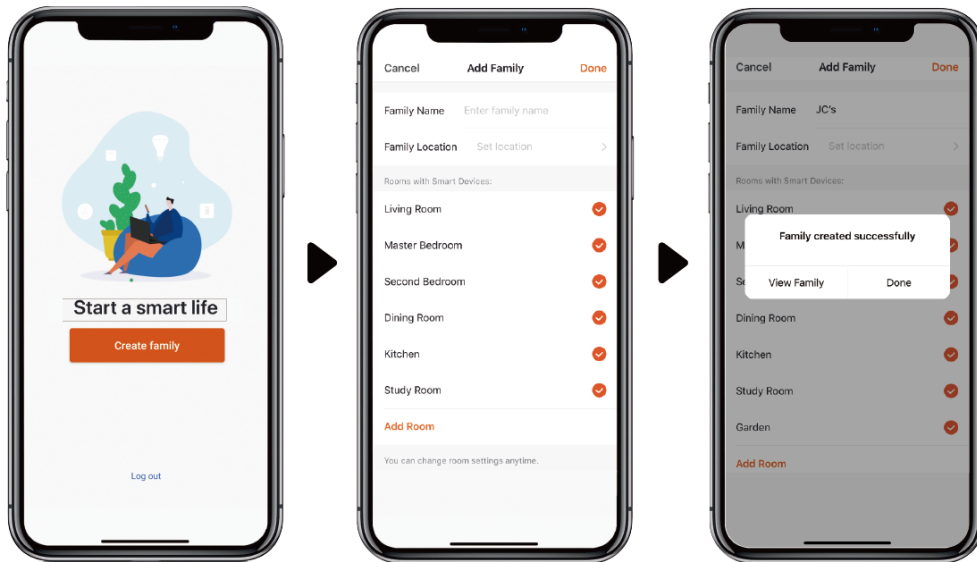

4 APP Pairing

Please make sure you are connected to the Wi-Fi.

1. Press **M** three times, then press **▲** to enter Wi-Fi setting. The screen will display the number of paired times. Enter Wi-Fi passwords in APP, during the pairing process,  will flash. After connecting successfully, the number will increase by one and the setting page will end automatically.



2. Click "Add Device", and then follow instructions to pair device.

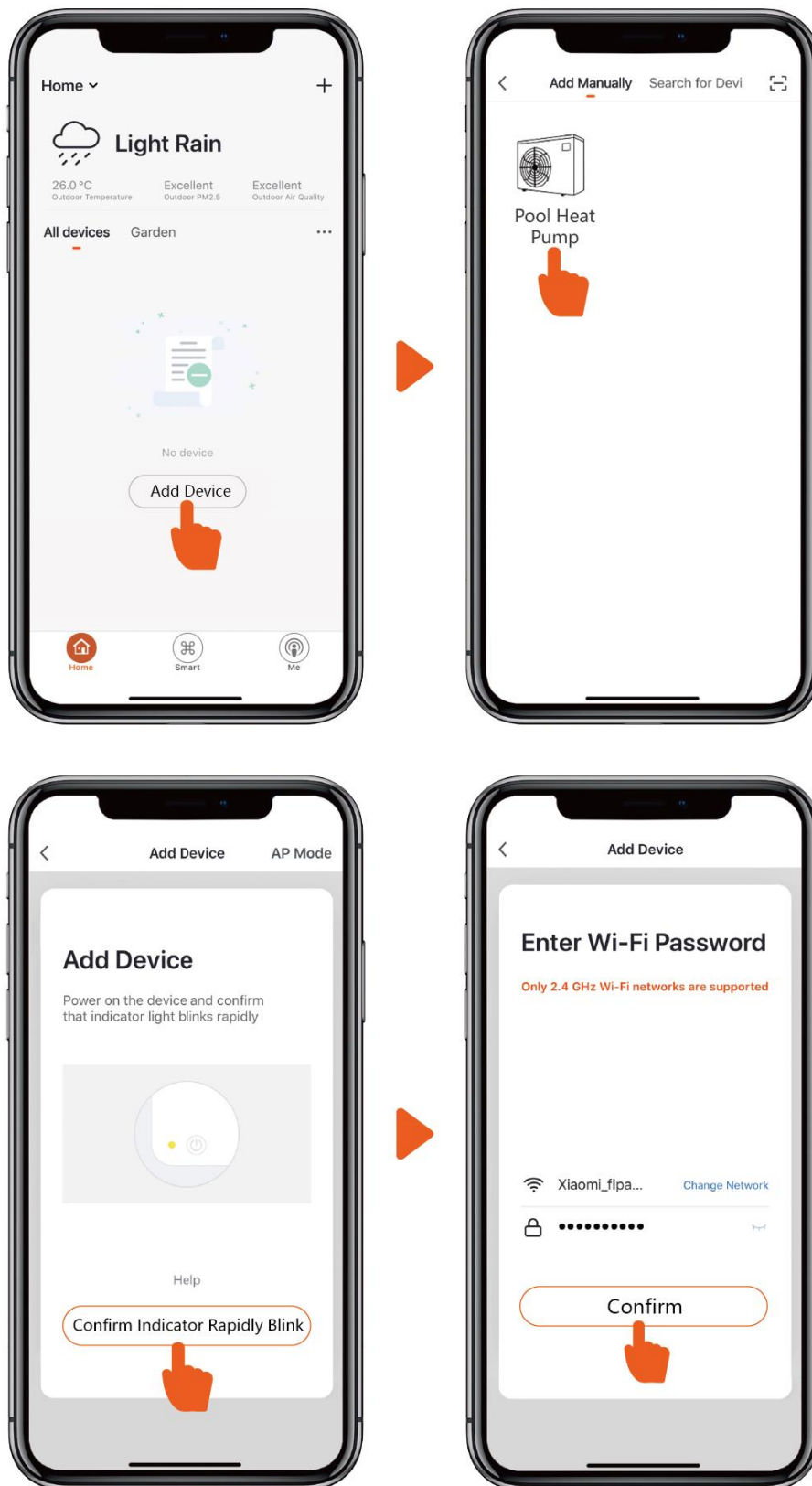

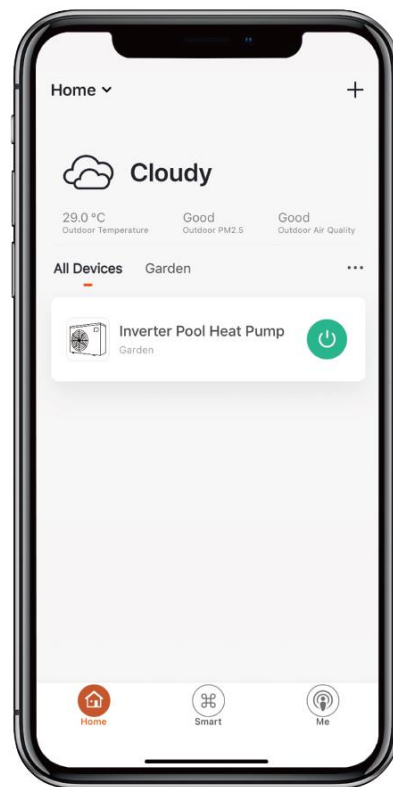
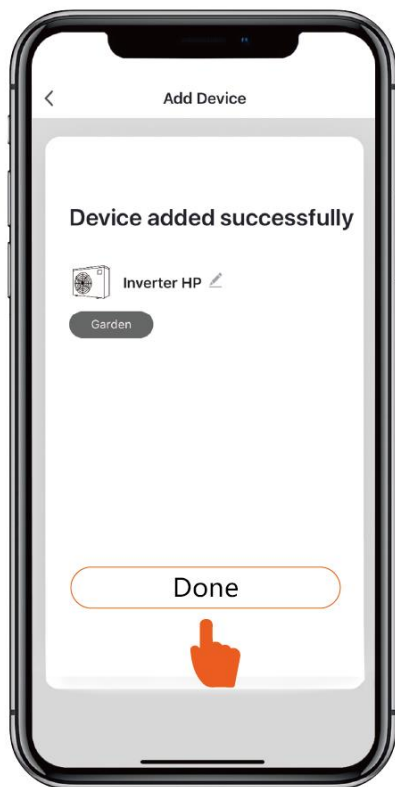
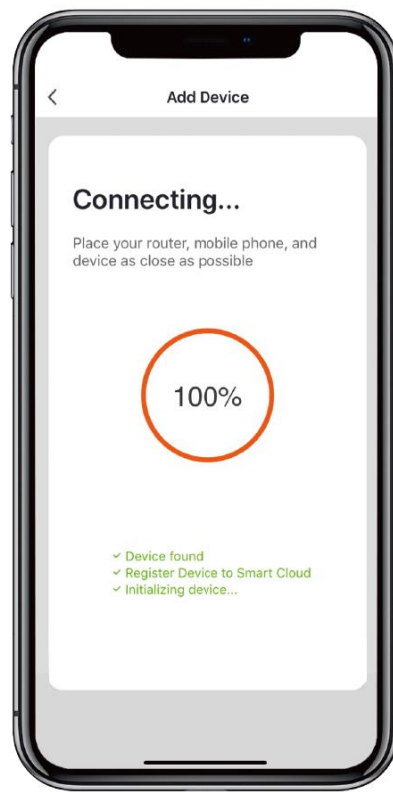
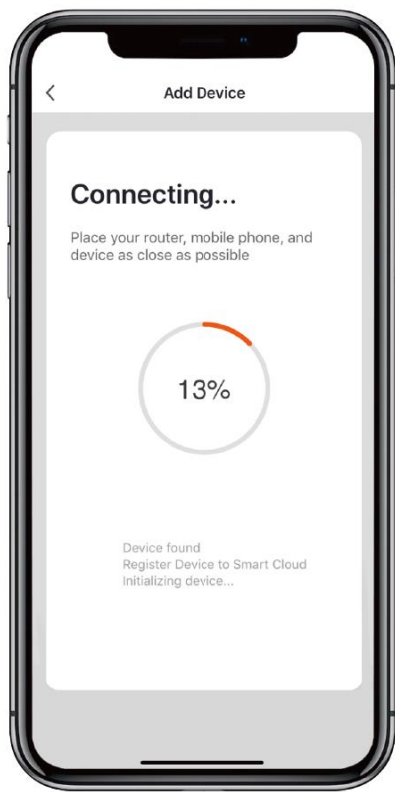

5 Operation

1. For heat pump with Heating function only :



2. For heat pump with Heating&Cooling function :



6 Share Devices to Your Family Members

After pairing, if your family members also want to control the device. Please let your family members register the APP first, and then the administrator can operate as below:

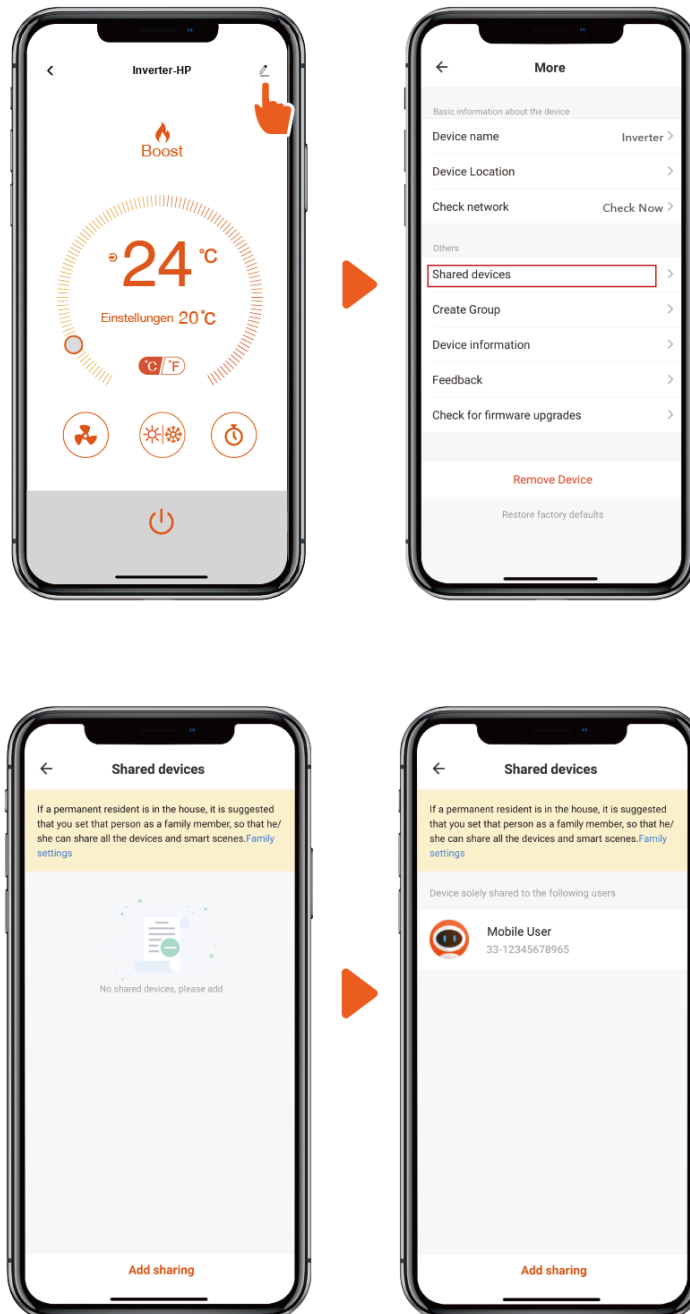

Notice: The weather forecast is just for reference.
App is subject to updating without notice.

