



C300S-LCD Instructions



Nanjing Bigstone Electronic & Technology co.,Ltd

Address: NO.35 Puzhou Road, Pukou District, Nanjing City, China
Tel: 025-89618445
Fax: 025 – 58849541
Email: bigstone.ebike@gmail.com

CONTENT

ABOUT THE USER MANUAL	2
OUTLOOK AND SIZE	2
MATERIAL AND COLOR	2
BUTTON DEFINITION	3
FUNCTION SUMMARY	4
FUNCTION SUMMARY	4
FULL VIEW AREA	5
NORMAL VIEW AREA	5
NORMAL OPERATION	6
1、MODE	6
2、CURRENT DISPLAY	6
3、SPEED DISPLAY	6
4、KM/H & MPH	7
5、BACKLIGHT INDICATOR	7
6、6 KM/H WORK	7
7、ASSIST LEVEL SELECTION	7
8、ERROE CODE INDICAYOR	8
9、SET OPEARATION	8
10、DISTANCE INDICATOR	10
11、BATTERY INDICATOR	11
12、CABLE DEFINITION	11
13、AUTO SLEEP AFTER 5 MINUTES	11
INSTALLATION INSTRUCTION	12
COMMON PROBLEM & SOLUTIONS	12
QUALITY & WARRANTY	13
QUALITY & WARRANTY:	13
OTHER ITEMS:	13
VERSION CHANGE	13
ERROR CODE TABLE	14

ABOUT THE USER MANUAL

Dear users,

To ensure better performance of your e-bike, please read through the C300S-LCD product introduction carefully before using it. We will inform you all the details concisely (including hardware installation, setting and normal use of the display) when using our display. Meanwhile, the introduction will also help you solve possible confusion and malfunction.

OUTLOOK AND SIZE

MATERIAL AND COLOR

C300S products are made of black ABS material and the buckle is made of nylon material. Under the temperature of -20 to 60°C, the shell material can ensure normal usage and good mechanical performance of the products.

Dimension figure (unit: mm).

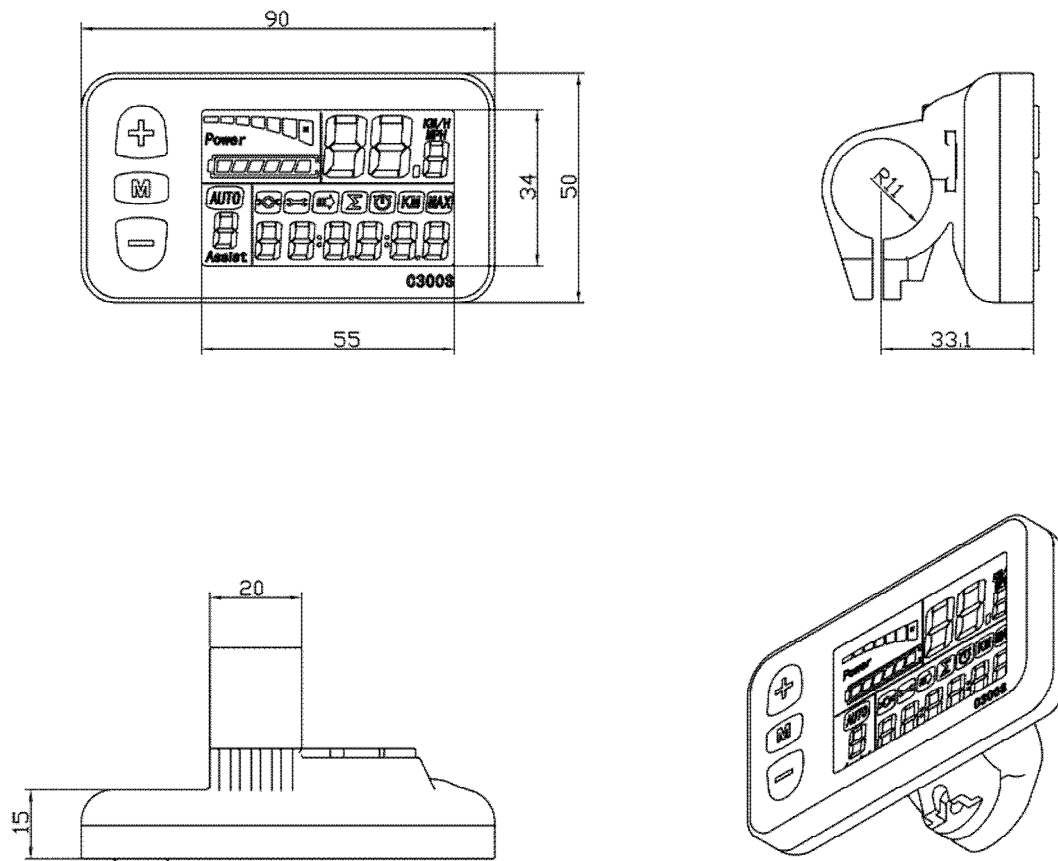

BUTTON DEFINITION

C300S has three buttons, including **MODE**、 **UP** and **DOWN**.

“MODE” names to “M”, “UP” names to “ + ” and “DOWN” names to “ — ”.

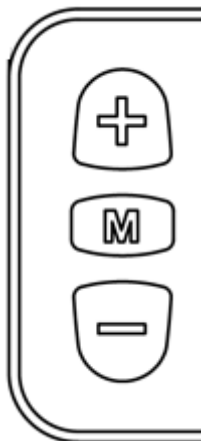

FUNCTION SUMMARY

FUNCTION SUMMARY

C300S provides a wide range of functions and indicators to fit the users' needs. The indicated contents are as below.

1. MODE
2. Current display
3. Speed display
4. KM/H & MPH
5. Backlight indicator
6. 6KM/H work
7. Assist level selection
8. Error code indicator
9. SET operation
10. Distance indicator
11. Battery indicator
12. Cable definition
13. Auto sleep after 5 minutes

FULL VIEW AREA

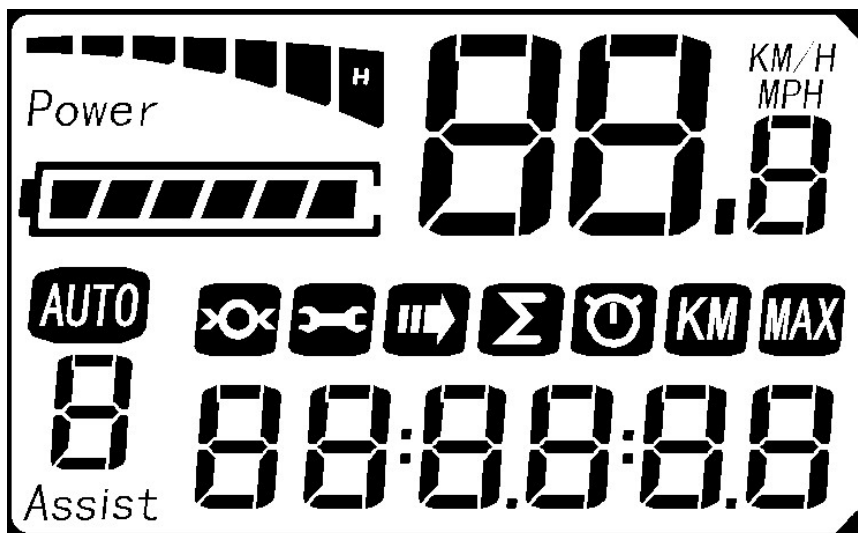

NORMAL VIEW AREA

The normal viewing area of the C300S is shown below.

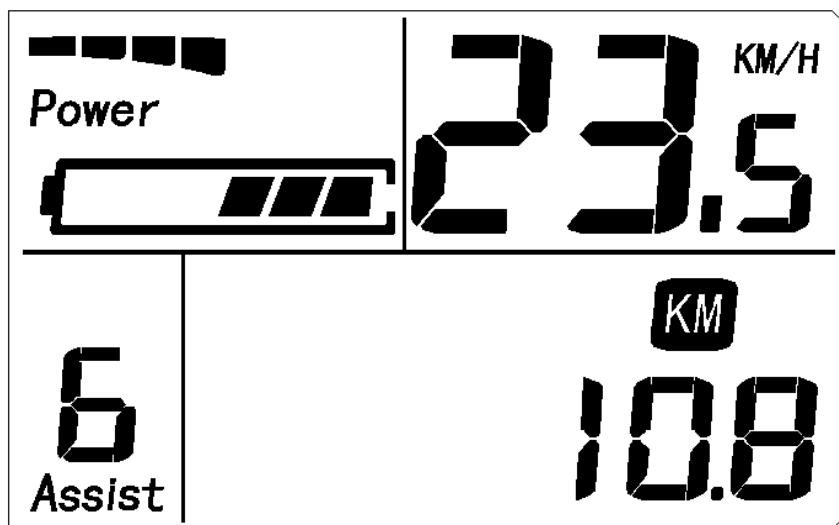

NORMAL OPERATION

1、 MODE

Hold **MODE** and start the display. The display will provide power for the controller. With display on, press **MODE** for 1.5 seconds to turn off the power. With the display off, there is no battery consumption. The leakage current is no more than 2 μ A.

※ The panel will go to sleep when speed is less than 2 km/h for 5 minutes.

2、 CURRENT DISPLAY

That represents the discharging current of the controller currently, each segment is 2A, six segments is ≥ 12 A.



3 、 SPEED DISPLAY

It displays the current riding speed of e-bike. The speed display is as below.



4、 KM/H & MPH

Select KM/H or MPH for the speed and mileage, display will be the currently selected units display.

5、 BACKLIGHT INDICATOR

With the power on, hold UP for 1.5 seconds and turn on the backlight. Click it again and turn off the backlight.

6、 6 KM/H WORK

Hold DOWN for 1.5 seconds and enter into the mode of power assist walk. The e-bike is traveling at 6Km/h. Display as shown below.



7、 ASSIST LEVEL SELECTION

Click **UP** or **DOWN** to change the stages and output power ratio, the output power range from level 1 to level 5 for the default (the levels can be customized by user) , the default value is level 1.



8、ERROE CODE INDICAYOR

If there is something wrong with the electronic control system, the display will flash at 1 HZ and show the error code automatically. Different error code is corresponding with different fault information, please see the last page Error code table for details.

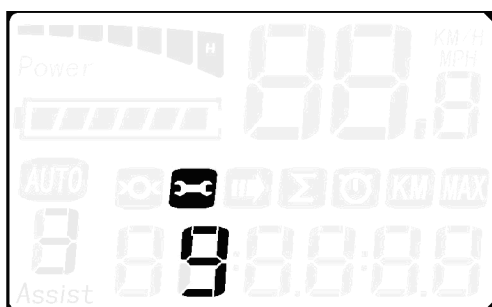

9、SET OPEARATION

Hold **DOWN & UP** 2 seconds to enter into the mode of setting. Click **MODE** to choose setting parameters and click **DOWN & UP** to exit setup.

9.1 Reset trip distance, trip time and max speed

Click **DOWN** to clear trip distance, trip time and max speed.

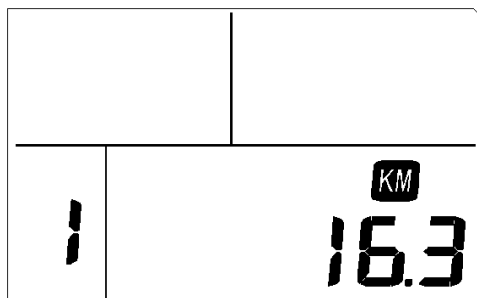

9.2 Max speed setting

The max speed is 40 km/h for the default. User can modify the value of max speed, when the riding speed exceeds the set value, the controller will stop supplying power to the e-bike, in order to ensure the safety of rider. The max speed ranges from 20 km/h to 34 km/h and then the max speed is 40km/h

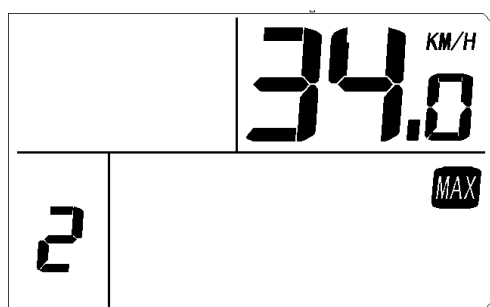

※ Click **UP** or **DOWN** to select the limited speed.

9.3 Wheel diameter setting

Select the accurate wheel diameter value to ensure the accuracy of display about speed and mileage.

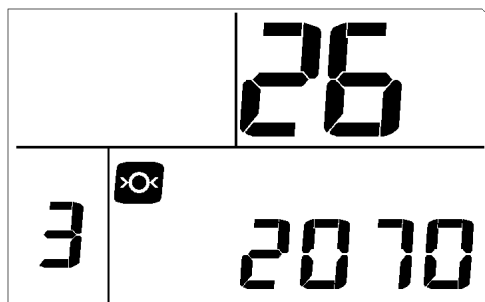

※ Click **UP** or **DOWN** to set the wheel diameter.

9.4 KM/H & MPH

Click **UP** or **DOWN** to switch the KM/H & MPH selection.

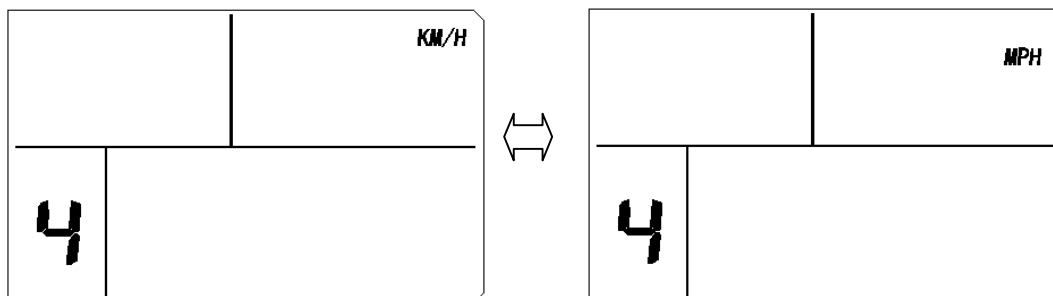

10、 DISTANCE INDICATOR

With the display on, click the **MODE** to switch the display information.

In turn shows ODO and trip time, trip distance, max speed, auto cycle display.

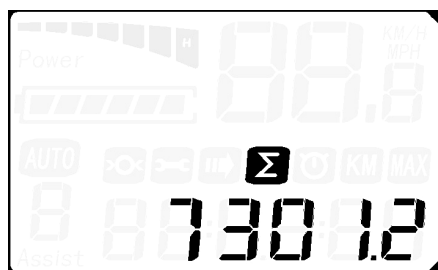

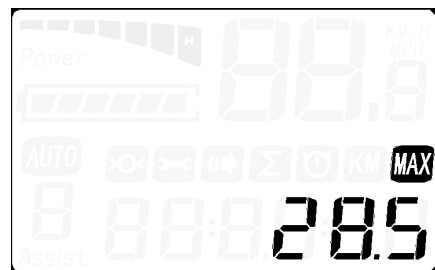
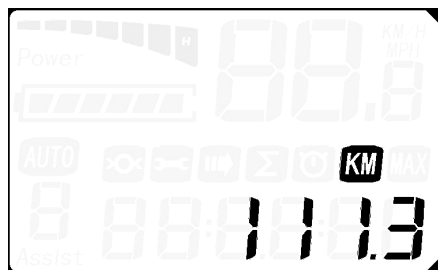

※  means auto cycle display.

11、 BATTERY INDICATOR

When the battery capacity is high, the six battery segments are all light.

When the battery is low, the battery frame will flash. It indicates that the battery is severely low and needs to be recharged immediately.

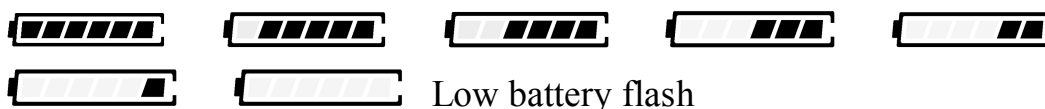

12、 CABLE DEFINITION

- 1 Red: Battery +
- 2 Blue: Weak lock
- 3 Black: Battery-
- 4 Green: UART-RECEIVE (RXD)
- 5 White: UART- SEND (TXD)

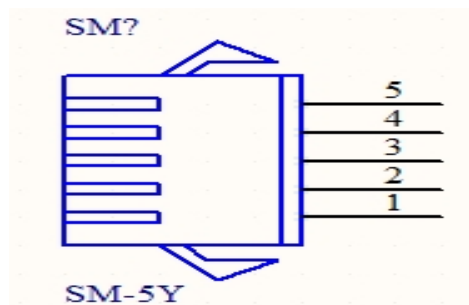

13、 AUTO SLEEP AFTER 5 MINUTES

When the riding speed is less than 2 km/h for 5 minutes, the system will go to sleep automatically.

INSTALLATION INSTRUCTION

The instrument is fixed on the handlebar, adjust the appropriate perspective, and the button is arranged on the easy control position. In the case of power failure the e-bike, the corresponding connector and connector controller instrument for inserting installation can be completed. Attentions! Install the instrument from right to left and avoid stretching buckle over angle.

Step1: Make the snap ring buckle into the handlebar in direction of the arrow.

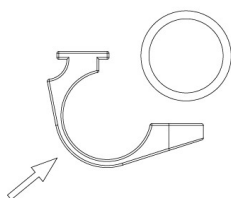

Step2: make the instrument slip insert the snap ring from right to left.

Step3: Adjust the direction and tighten the low screw after installation.

COMMON PROBLEM & SOLUTIONS

Q: Why the display is not able to start up?

A: Checking the connector that between display and controller.

Q: How to deal with the error code?

A: Fix it to the maintenance place immediately. If cannot be resolved, you can go to the electric vehicle repair points repair it in a timely manner.

QUALITY & WARRANTY

QUALITY & WARRANTY:

- 1、 Any quality problems in normal case and in guarantee period, our company will responsible for the warranty
- 2、 The warranty time is 18 months from date of purchasing.

OTHER ITEMS:

The following items are not belong to warranty scope.

1. It can not be demolished.
2. The damage caused by wrong installation or operation.
3. Shell is broken when display is out of the factory.
4. Wire is broken.
5. Force disaster (such as fire, earthquake, etc.) or natural disasters like lightning, etc caused by fault or damage.
6. Beyond Warranty period.

VERSION CHANGE

The instrument instructions are the operating instructions of common software version of Nanjing Bigstone Electronic & Technology Co., Ltd. (V3.1 version). The instrument software version that using on the part of the vehicle are likely different from this specification, with the actual use of version shall prevail.

ERROR CODE TABLE

The error code is corresponding with the fault definition.

Error code	Definition
21	Current Abnormality
22	Throttle Abnormality
23	Motor Phase Abnormality
24	Motor Hall Signal Abnormality
25	Brake Abnormality
9	Panel Communication Abnormality