CDC6 Specification

Contents

1. About the user manual.....	3
2. Material and external dimensions.....	3
Real product.....	3
Dimension figure: (unit: mm).....	4
3. Function summary.....	5
4. Button definition.....	7
5. Installation instructions.....	7
6. Normal operation.....	8
(1) Display on/off.....	8
(2) Turn on/off of front lights.....	9
(3) Opening/closing of USB charging function.....	9
(4) PAS level selection and 6Km/h implementation mode.....	10
(5) Display interface.....	10
(6) Battery power indication.....	12
(7) Error code definition.....	12
(8) Motor power indication.....	13
7. General setting.....	13
(1) Password setting.....	13
(2) Wheel diameter selection.....	16
(3) Speed unit setting.....	18
(4) Speed limit setting.....	18
(5) Version information indication.....	19
8. Cable outlet define.....	21
9. Q&A.....	19

10. Quality assurance and warranty scope.....	19
Warranty.....	20
Other items.....	20
Error code definition table.....	20

1. About the user manual

Dear users:

To ensure better performance of your ebike, please read through the CDC6 instruction carefully before using it. We will inform you of all the details, including the installation and function setting of the display with the most concise words. Meanwhile, the specification will also help you to solve possible malfunction.

2. Material and external dimensions

The CDC6 products use the 3.5-inch LCD screen with a light and beautiful button, double side printed board, nylon buckle and ABS material shell. Under the temperature ranging from -20°C to 60°C , the shell material can ensure the good mechanical performance of the products.

Real product

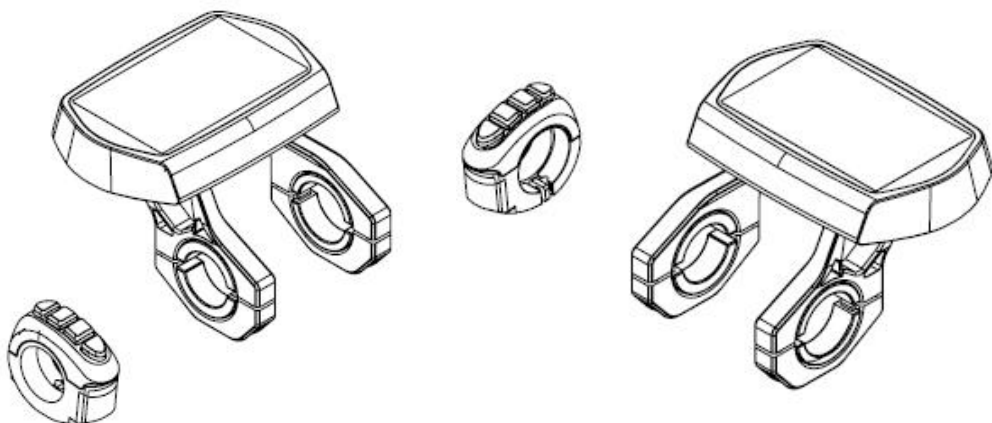



Figure 2-1

Dimension figure :(unit: mm)

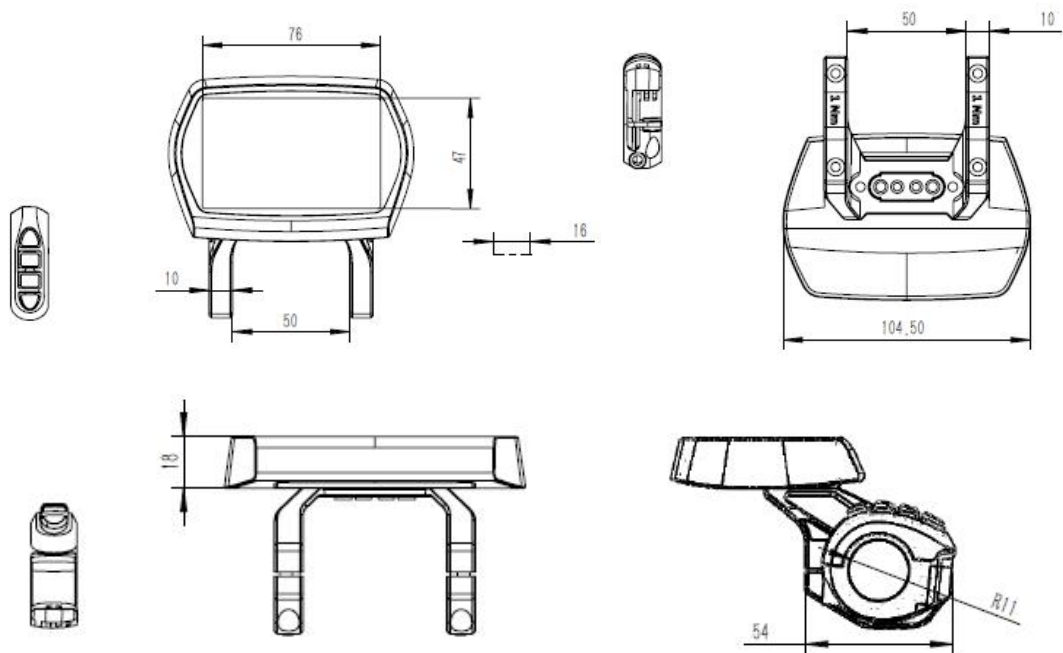

Figure 2-2

3.Function summary

CDC6 is a Multifunctional display that integrated with 3.5 inch LCD. The same display can match 24V, 36V, 48V battery. At the same time integrated with 24V, 36V and 48V front lights. With another product CDBL_C of our company will greatly simplify the handlebar cable. The default sleep time of the display is 10min. CDC6 functions summary (figure 3-1)

- ◆ Total distance indicator
 - ◆ Riding distance indicator
 - ◆ Current speed indicator
 - ◆ Car lamp display
 - ◆ PAS level selection
 - ◆ Battery residual capacity indicator
 - ◆ Error code definition
 - ◆ Kilometers or miles
 - ◆ Wheel diameter selection
 - ◆ USB charging function
 - ◆ 6Km/implementation function
-

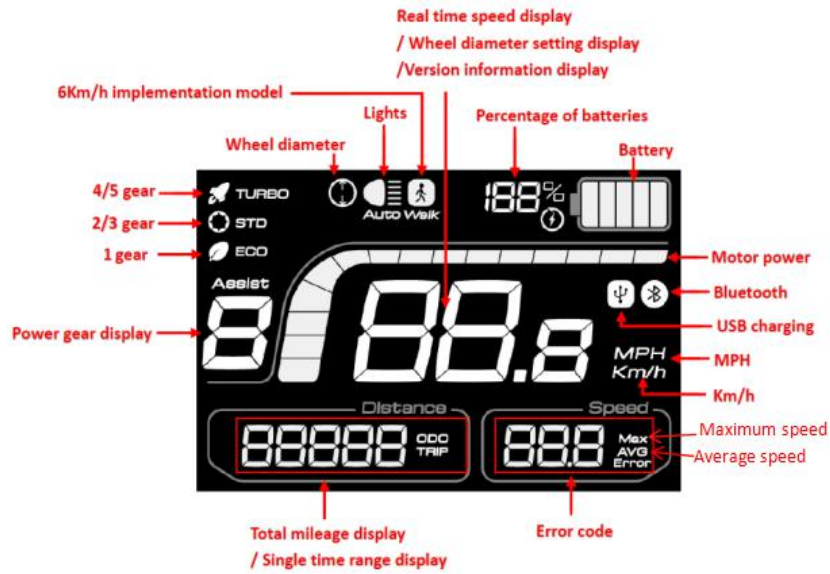

Figure 3-1

Display all (figure 3-2)

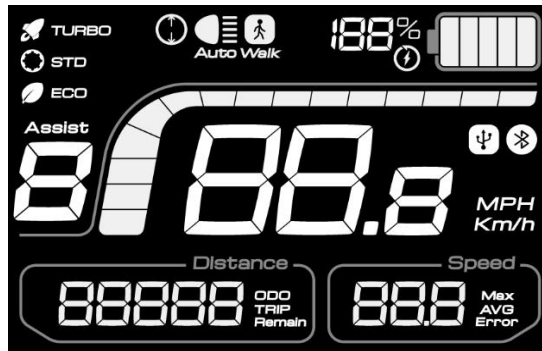

Figure 3-2

Display during use (The backlight is always bright) (figure 3-3)

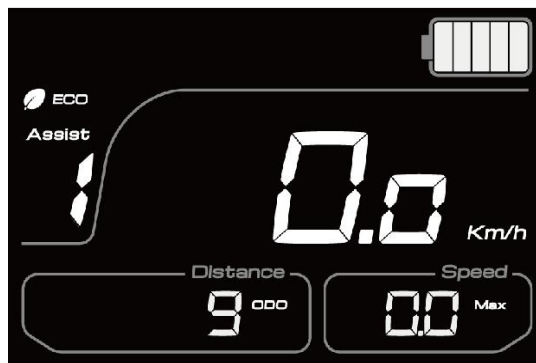

Figure 3-3

4.Button definition

CDC6 has four buttons including SET , UP, DOWN and ON/OFF.

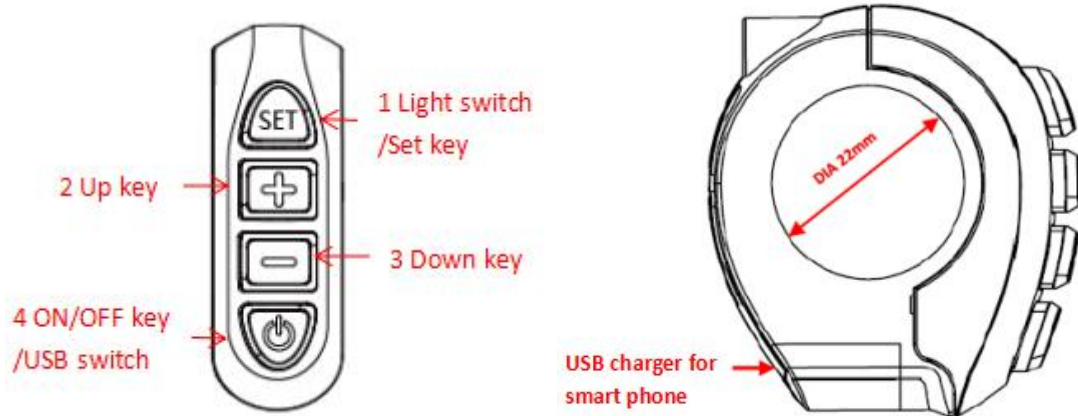

Figure 4

5.Installation instructions

The display will be fixed on the handlebar, and you can adjust it to the best degree for view. Tighten the screws to finish the installation.



Insert the clasp into the vehicle tube



Tighten the screws to complete the installation.

6.Normal operation

(1) Display on/off



Clicking  button, the display starts to work. You can hold  button for 3 seconds to turn off the display. The display is no longer cost the battery power. The leakage current is less than $2\mu\text{A}$. The operation process is shown in figure 6-1:



Figure 6-1

(2) Turn on/off of front lights

When the display is power on, click  button to turn on the lights. Then

clicking  button again, the front lights are closed. The operation process is shown in figure 6-2: (the lights are on)



Figure 6-2

(3) Opening/closing of USB charging function



When the display is power on, click  button to set up the USB charging function. Then clicking it again, the USB charging function is closed. The operation process is shown in figure 6-3: (The USB charging function is open)



Figure 6-3

(4) PAS level selection

When the display is power on, you can click  or  button to adjust the PAS level which will change the output power of the motor. The PAS level is

normally set at level 1 when you power on the display, you can adjust it from 0 to 5.

The long pressing  key will enter the implementation mode of 6Km/h. The operation process is shown in figure 6-4: (6Km/h implementation mode)

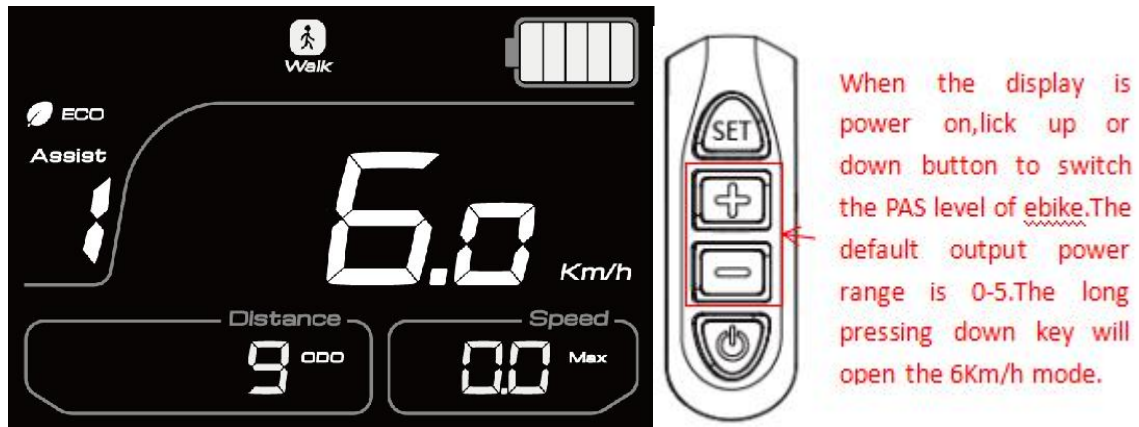

Figure 6-4

(5)Display interface

Display will show: current speed, total distance, single distance, PAS level, power, error code, motor power information and other modes.The current speed is shown in figure 6-5.



Figure 6-5

The total distance is shown in figure 6-6:

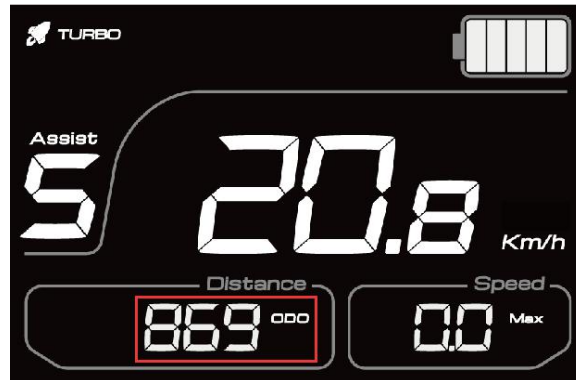

Figure 6-6

The single distance is shown in figure 6-7:

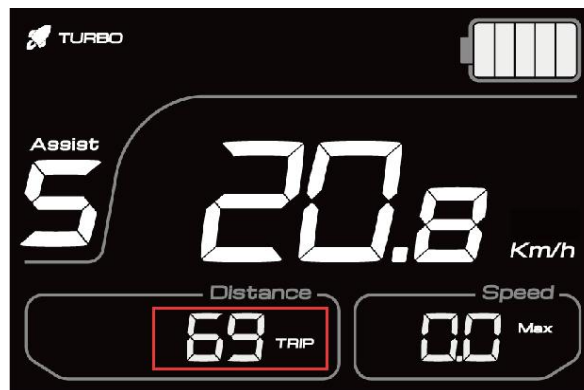

Figure 6-7

The PAS level display (level 3 in below figure) is shown in figure 6-8:

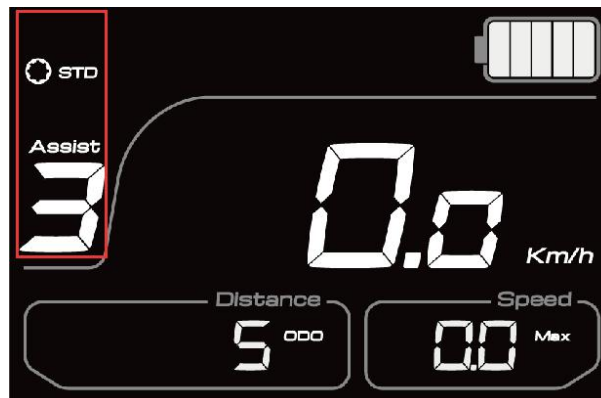

Figure 6-8

The battery power is shown in figure 6-9(the current remaining power is 3)



Figure 6-9

(6)Battery power indication

There will be five bars shown on the screen if the battery capacity is very high enough. The less bars will show on the screen if the capacity of the battery is less. When the battery is almost dead, the last bar will flash. You need to charge the battery immediately. As shown in figure 6-10:



Figure 6-10

(7)Error code definition

When the ebike drive system fails, it will stop working, and the display will show the error code on the screen automatically. The error code will not stop showing on the screen until the problem is solved. The reason for the error is shown in the

attachment of error code definition table.

The display error code is shown in figure 6-11:



Figure 6-11

(8) Motor power display

The controller will feedback the motor power to the display, so that the display can show it in real time. The riding power is shown in figure 6-12

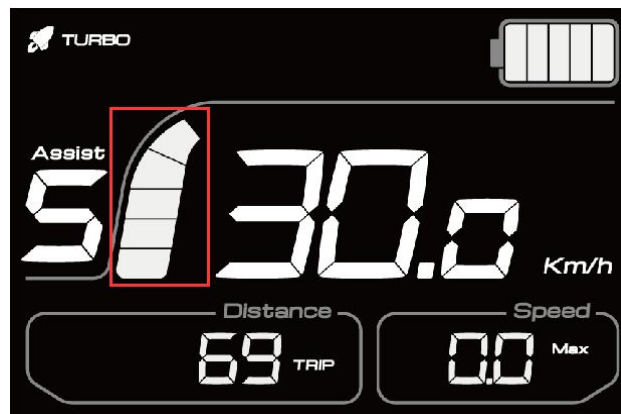

Figure 6-12

7. General setting

(1) Password setting





This display's default password is 1919. You can enter the operation interface to set

other functions by entering the correct password according to the following operation mode.

When the display is power on,hold  button for 3seconds to enter the password inputting interface, as shown in figure 7-1.



Figure 7-1

Click  or  button to enter the first password number setting interface, the number will be changed from 0 to 9 or 9 to 0 step by step when you click  or  button ,as shown in figure 7-2.

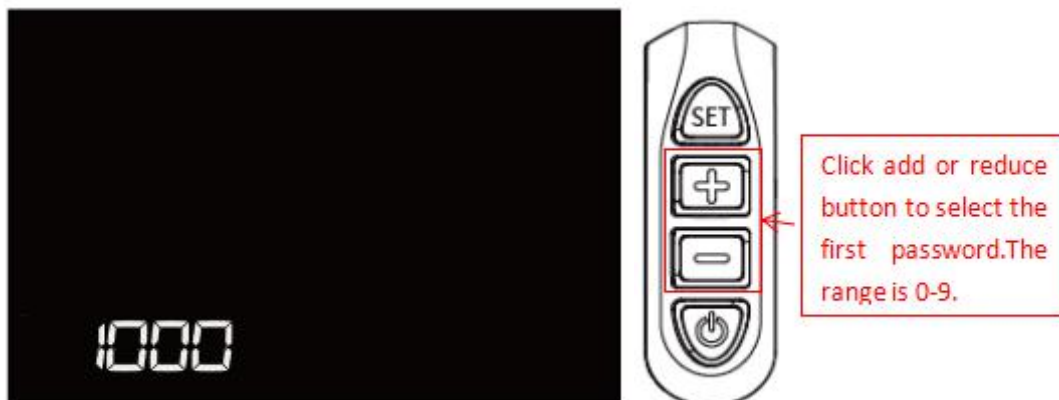





Figure 7-2

To confirm the first password number, click  button, and it will enter the second password setting interface simultaneously. Each time you click  or  button, the number changes from 0-9 or 9-0 step by step, as shown in figure 7-3.

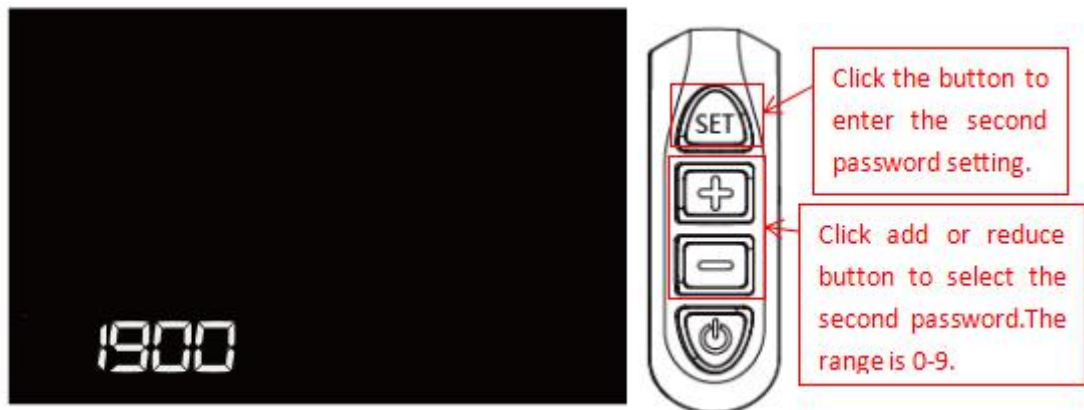





Figure 7-3

To confirm the second password number, click  button, it will enter the third password setting interface simultaneously. Each time you click  or  button, the number changes from 0-9 or 9-0 step by step, as shown in figure 7-4.

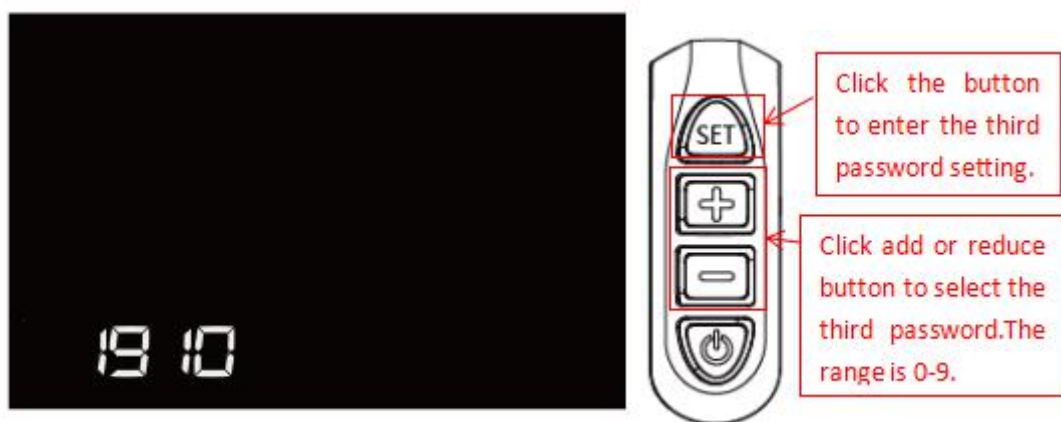





Figure 7-4

To confirm the third password number, click  button, it will enter the fourth password setting interface at the same time. Each time you click  or  button, the number changes from 0-9 or 9-0 step by step, as shown in figure 7-5.

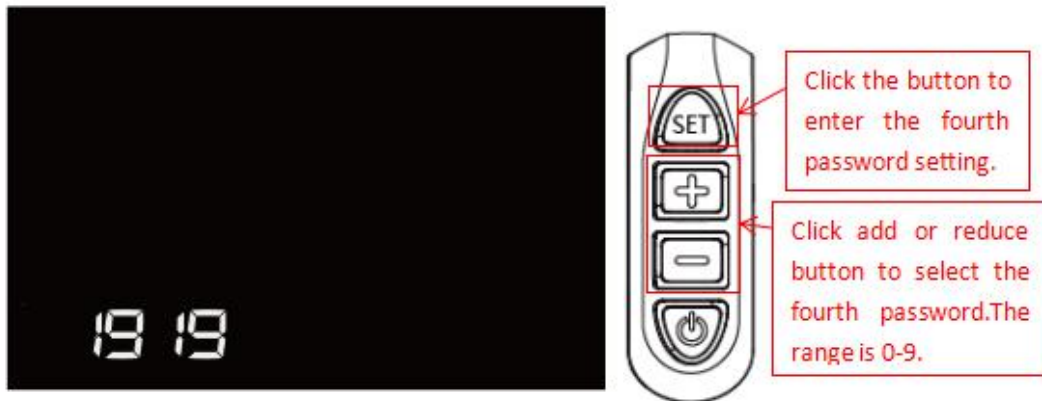

Figure 7-5

To confirm the fourth password number, click  button. After you enter into the 4 correct passwords, the display will enter the wheel diameter setting interface, as shown in the figure 7- 6.





Figure 7- 6

(2) Wheel diameter selection

After entering the correct password, the display will enter into the wheel diameter setting interface, as mentioned above. The selected wheel diameter parameters, as shown in figure7-7:

轮径值
12 寸 (957mm)
16 寸 (1272mm)
18 寸 (1350mm)
20 寸 (1590mm)
22 寸 (1770mm)
24 寸 (1948mm)
26 寸 (2072mm)
28 寸 (2260mm)

Figure 7-7

By clicking  or  button, you can select the corresponding wheel diameter to ensure the accuracy of display speed and distance indication. The factory default wheel diameter is 26C. The wheel diameter setting is shown in figure7-8: (the wheel diameter in the figure is 26C)

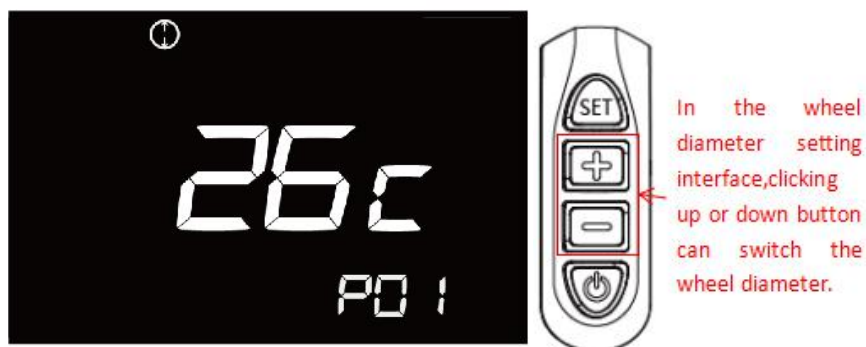





Figure 7-8

(3)Speed unit setting

After finishing the wheel diameter setting, click  key to enter the speed unit setting interface. And then, the unit will be switched by clicking  or  key, as shown in figure 7-9:

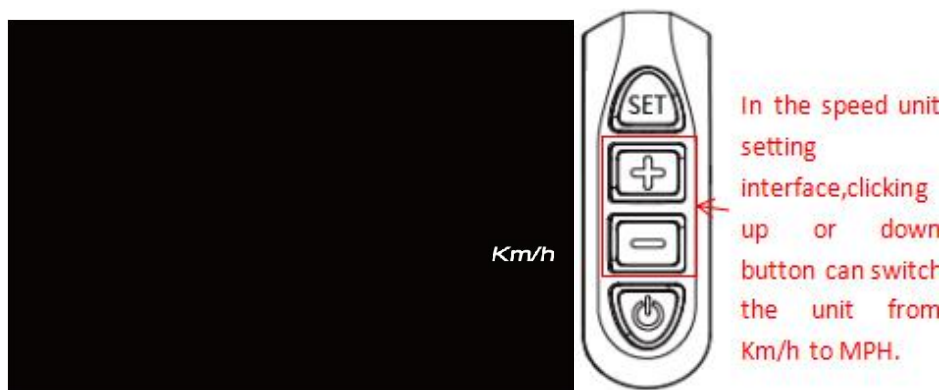





Figure 7-9

(4)speed limit setting

After finishing the speed unit selection, click  key to enter the speed limit setting interface. The speed limit can be adjusted by clicking  or  key, and the conventional maximum limit speed 25Km/h can be customized. The operation process is shown in figure 7-10 (speed shown in figure is 25Km/h).

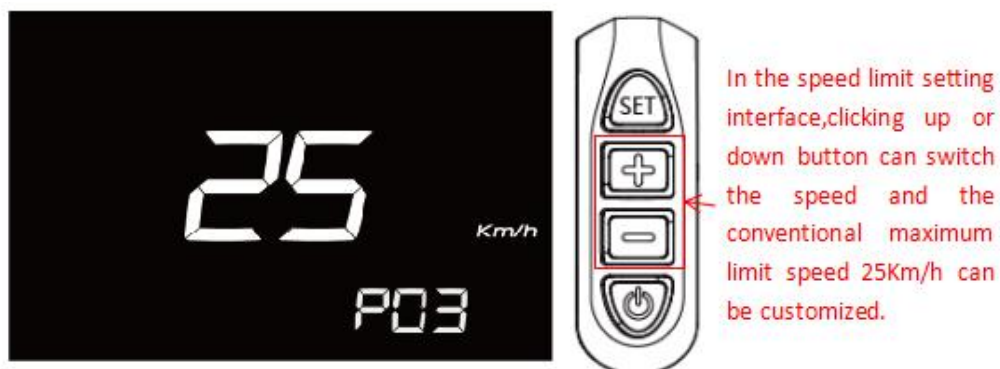



Figure 7-10

(5) Version information indication

After finishing the speed limit setting, click  key, it will enter into the software version information interface. We can better identify the system state by reading the software version to find out the original source code to better serve you. The version information is shown in figure 7-11 (the current version is F7.0)

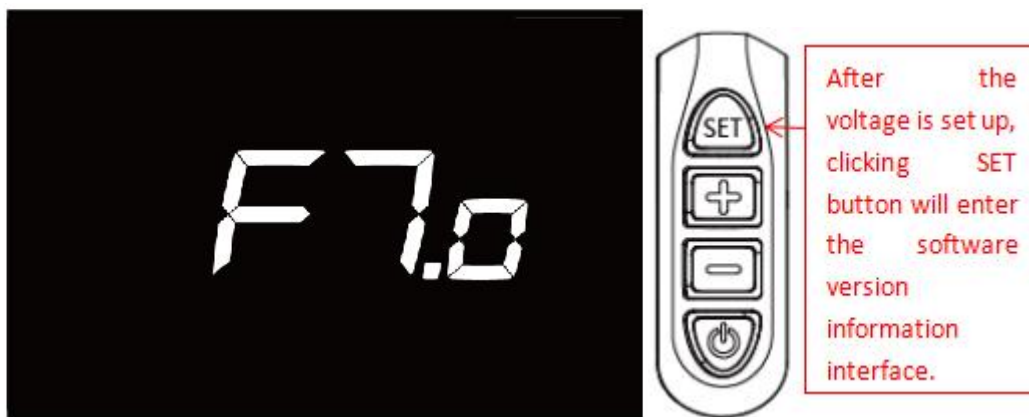

Figure 7-11

9.Q&A

Q: Why the display is not able to start up?

A: Check the connector that between display and controller.

Q: How to deal with the error code?

A: Fix it to the maintenance place immediately. If it cannot be resolved, you can go to the electric vehicle repair points repair it in a timely manner.

10.Quality assurance and warranty scope

Warranty

- (1) Under warranty, our company will shoulder the responsibility to provide limited warranty to any faults caused by the quality of the product under normal use.
- (2) The warranty period lasts for 18 months since the date of purchase.

Other items

The following items does not belong to warranty scope

- (1) Disassembly or modification without authorization.
- (2) Malfunction or damage caused by the misuse or improper installation and debugging by the users or the third party.
- (3) Shell scratch or breakage after leaving the factory.
- (4) Wiring scratch or breakage.
- (5) Malfunction or damage caused by the force majored (fire, earthquake etc.) or natural disasters (lightening etc.)
- (6) Beyond Warranty period.

Error code definition table

There will be error code showed on the display while the system doesn' t work.

1. Error code0x01: Then display is in normal condition.
 2. Error code0x03: The ebike is braking.
 3. Error code0x04: The throttle is no homing (staying in the hing position).
-

-
4. Error code0x05: Throttle is broken.
 5. Error code0x06: Battery is under voltage protection.
 6. Error code0x07: Overvoltage protection.
 7. Error code0x08: Motor Holzer signal line is broken
 8. Error code0x09: Motor phase is broken.
 9. Error code0x10: The controller temperature is high enough to reach the protection point.
 10. Error code0x11: The motor temperature is high enough to reach the protection point.
 11. Error code0x12: Current sensor is broken.
 12. Error code0x13: Battery temperature is broken.
 13. Error code0x14: Temperature sensor in motor is broken.
 14. Error code0x15: Temperature sensor in controller is broken.
 15. Error code0x21: PAS is broken.
 16. Error code0x22: BMS communication is failure.
 17. Error code0x23: The front light is broken.
 18. Error code0x24: The front light is failure.
 19. Error code0x25: Torque signal of torque sensor is failure.
 20. Error code0x26: Speed signal of torque sensor is failure.
 21. Error code0x30: Communication is failure.
-