

**PCA-2264  
WINCH SUPPORT FOR VERTICAL PULLING**

**USER MANUAL**

# PCA-2264

## WINCH SUPPORT FOR VERTICAL PULLING

**User Manual**  
**READ CAREFULLY**

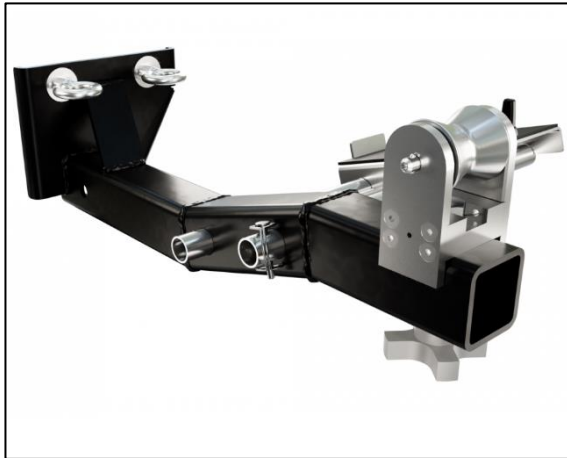

Portable Winch Co. thanks you for your confidence and congratulates you on the purchase of the **Winch support for vertical pulling PCA-2264**.

The **Winch support for vertical pulling** is composed of three main elements:

- A : Frame
- B : Adjustable shelf
- C : Redirect pulley

If any of the items are missing, please contact your

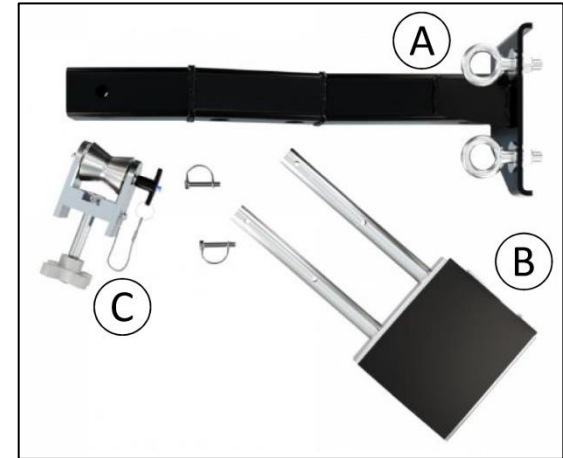

authorized dealer.

The **Winch support for vertical pulling** can be anchored to different accessories depending on the available anchor point and the work to be done. All are sold separately.

Refer to the **anchors chart** on the following page to find your situation and to know the installation and operating instructions.

**⚠ ATTENTION** IN ORDER TO USE THIS PRODUCT SAFELY, IT IS IMPORTANT THAT **ALL USERS READ THIS MANUAL CAREFULLY**.

**⚠ WARNING** NEVER ATTEMPT TO LIFT MORE THAN THE RATED LIFTING CAPACITY OF THE WINCH IN SINGLE LINE. REFER TO THE USER'S MANUAL FOR THE WINCH MODEL USED.

**⚠ WARNING** PERFORM A TEST PULL WITH A LIGHT LOAD IN ORDER TO ASSES THE STABILITY OF THE EQUIPMENT.

**⚠ ATTENTION** AFTER PULLING FOR A FEW SECONDS, RELEASE THE TENSION AND CHECK THE SOLIDITY OF THE INSTALLATION.





# PCA-2264

## WINCH SUPPORT FOR VERTICAL PULLING

**User Manual**  
**READ CAREFULLY**

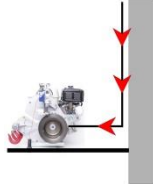
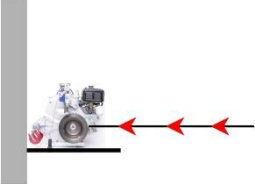
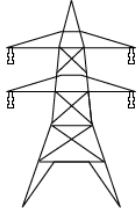

### ANCHORS CHART

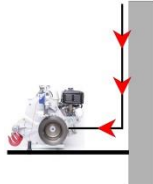
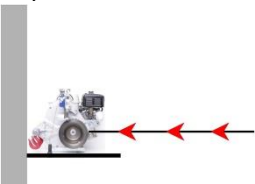



TYPE OF ANCHOR POINT	ANCHORING ACCESSORY TO BE USED TO ATTACH PCA-2264 SUPPORT	WINCH POSITION AND DESIRED ROPE DIRECTION	REFERENCE
<p>Cylindrical shape (tree, pole, etc.)</p> 	<p><b>PCA-1263</b> Winch anchor system for trees and poles.</p> 	<p>The winch faces the anchoring. The rope comes from the top towards the winch (vertical).</p> 	<p>Installation no. 1 (page 5)</p>
		<p>The winch faces the load. The rope is directly in line with the winch (horizontal).</p> 	<p>Installation no. 2 (page 6)</p>
<p>Pylon (with 'V' shaped legs at 90°)</p> 	<p><b>PCA-1806</b> Pylon mount winch anchor.</p> 	<p>The winch faces the anchoring. The rope comes from the top towards the winch (vertical).</p> 	<p>Installation no. 3 (page 7)</p>
		<p>The winch faces the load. The rope is directly in line with the winch (horizontal).</p> 	<p>Installation no. 4 (page 8)</p>

# PCA-2264

## WINCH SUPPORT FOR VERTICAL PULLING

**User Manual**  
**READ CAREFULLY**

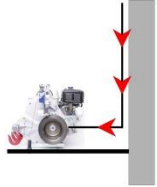
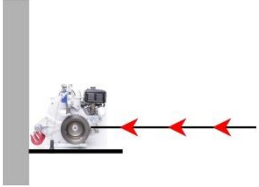

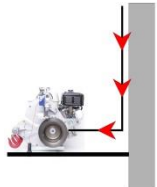
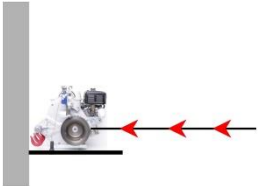
TYPE OF ANCHOR POINT	ANCHORING ACCESSORY TO BE USED TO ATTACH PCA-2264 SUPPORT	WINCH POSITION AND DESIRED ROPE DIRECTION	REFERENCE
<p>Vehicle</p> 	<p><b>PCA-1267 ou PCA-1501</b> Square tube for trailer hitch.</p> 	<p>The winch faces the anchoring. The rope comes from the top towards the winch (vertical).</p> 	<p>Installation no. 5 (page 9)</p>
		<p>The winch faces the load. The rope is directly in line with the winch (horizontal).</p> 	<p>Installation no. 6 (page 10)</p>
	<p><b>PCA-1266</b> Heck-Pack anchoring system with adaptor for 50 mm towing balls.</p> 	<p>The winch faces the anchoring. The rope comes from the top towards the winch (vertical).</p> 	<p>Installation no. 7 (page 11)</p>
		<p>The winch faces the load. The rope is directly in line with the winch (horizontal).</p> 	<p>Installation no. 8 (page 12)</p>

# PCA-2264

## WINCH SUPPORT FOR VERTICAL PULLING

**User Manual**  
**READ CAREFULLY**

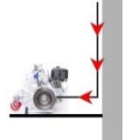

	Installation no. 1 - The winch faces the anchoring. The rope comes from the top towards the winch (vertical).		
	Accessories used		
	A	PCA-1263 Winch anchor system for <b>trees and poles</b>	
	B	PCA-2264 Winch support for vertical pulling	

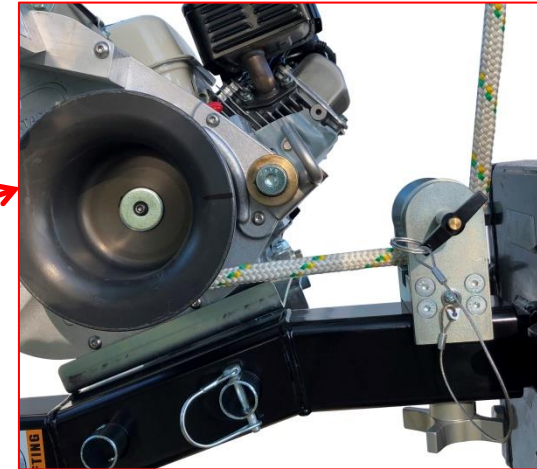
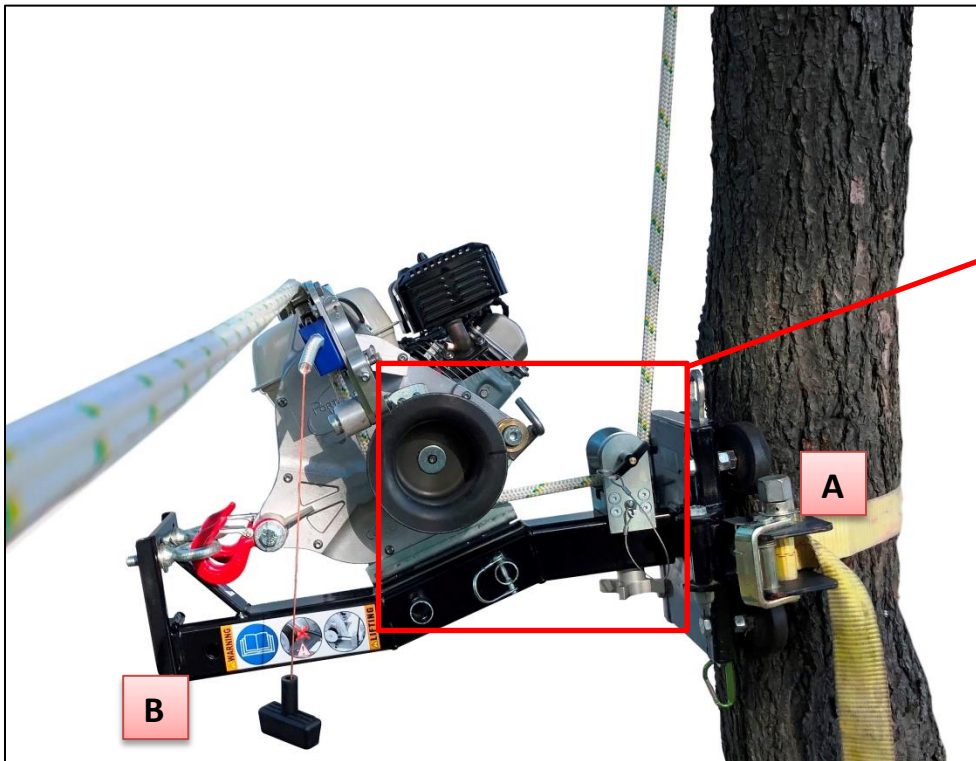

**⚠ ATTENTION** **DO NOT** GO OVER THE ROPE ENTRY PULLEY OF THE WINCH WITH THE ROPE AS IT WILL CREATE FRICTION AND WILL REDUCE LIFTING CAPACITY. **GO UNDER THE ROPE ENTRY PULLEY OF THE WINCH.** IN THIS CASE, THE ROPE ENTRY PULLEY OF THE WINCH WILL NOT BE USED.

# PCA-2264

## WINCH SUPPORT FOR VERTICAL PULLING

**User Manual**  
**READ CAREFULLY**



	Installation no. 2 - The winch faces the load. The rope is directly in line with the winch (horizontal).	
	Accessories used	
	A	PCA-1263 Winch anchor system for <b>trees and poles</b>
	B	PCA-1332 Pivoting anchor for vertical pull support
C	PCA-2264 Winch support for vertical pulling	

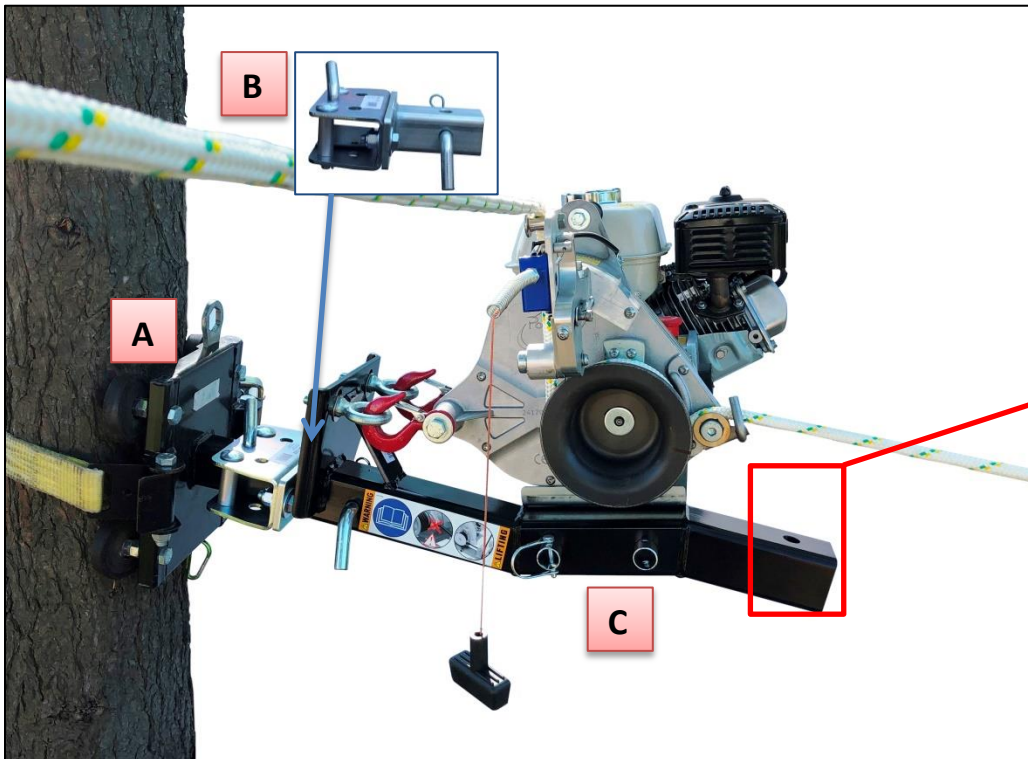
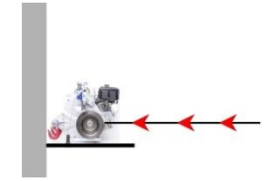

IN THIS SITUATION,  
**DO NOT USE THE REDIRECT PULLEY**  
Supplied with the  
Winch support for  
vertical pulling.

**⚠ ATTENTION** WHEN USED IN DIRECT LINE, THE PIVOTING ANCHOR FOR VERTICAL PULL SUPPORT (PCA-1332) MUST BE FIXED TO THE WINCH SUPPORT FOR VERTICAL PULL (PCA-2264). THIS ANCHOR (SOLD SEPARATELY) WILL ALLOW THE WINCH TO ALIGN WITH THE LOAD.

**⚠ ATTENTION** PUT THE ROPE ON THE WINCH ENTRY PULLEY.



# PCA-2264

## WINCH SUPPORT FOR VERTICAL PULLING

**User Manual**  
**READ CAREFULLY**

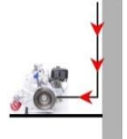

	Installation no. 3 - The winch faces the anchoring. The rope comes from the top towards the winch (vertical).		
	Accessories used		
	A	PCA-1806	
B	PCA-2264	Winch support for vertical pulling	

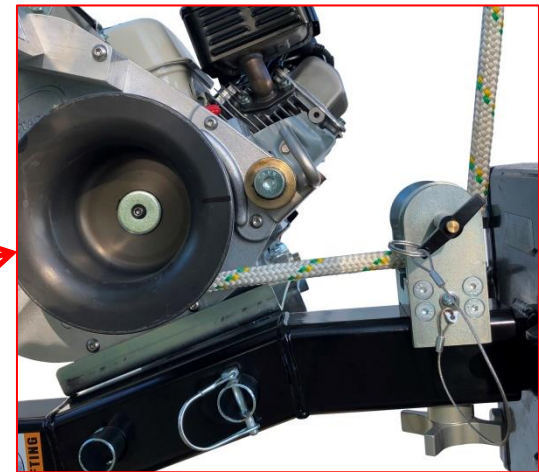
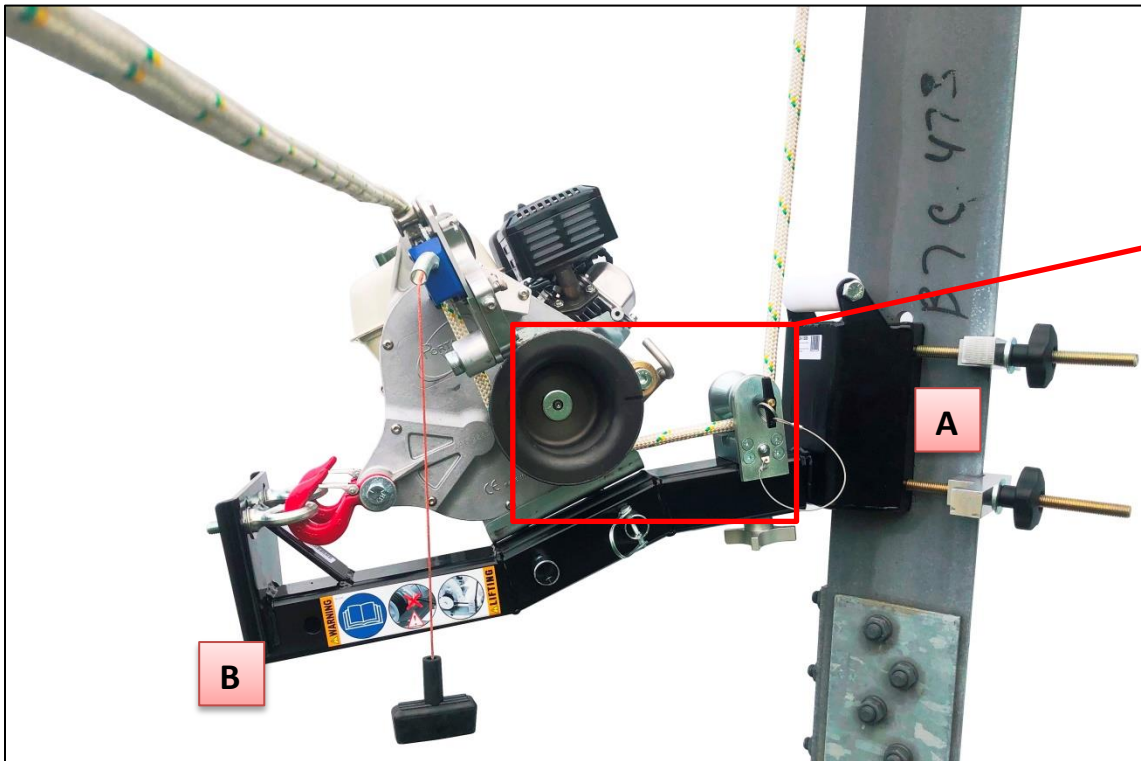

**⚠ ATTENTION** **DO NOT** GO OVER THE ROPE ENTRY PULLEY OF THE WINCH WITH THE ROPE AS IT WILL CREATE FRICTION AND WILL REDUCE LIFTING CAPACITY. **GO UNDER THE ROPE ENTRY PULLEY OF THE WINCH.** IN THIS CASE, THE ROPE ENTRY PULLEY OF THE WINCH WILL NOT BE USED.

# PCA-2264

## WINCH SUPPORT FOR VERTICAL PULLING

**User Manual**  
**READ CAREFULLY**

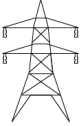

	Installation no. 4 - The winch faces the load. The rope is directly in line with the winch (horizontal).	
	Accessories used	
	A	PCA-1806 Pylon mount winch anchor
	B	PCA-1332 Pivoting anchor for vertical pull support
C	PCA-2264 Winch support for vertical pulling	

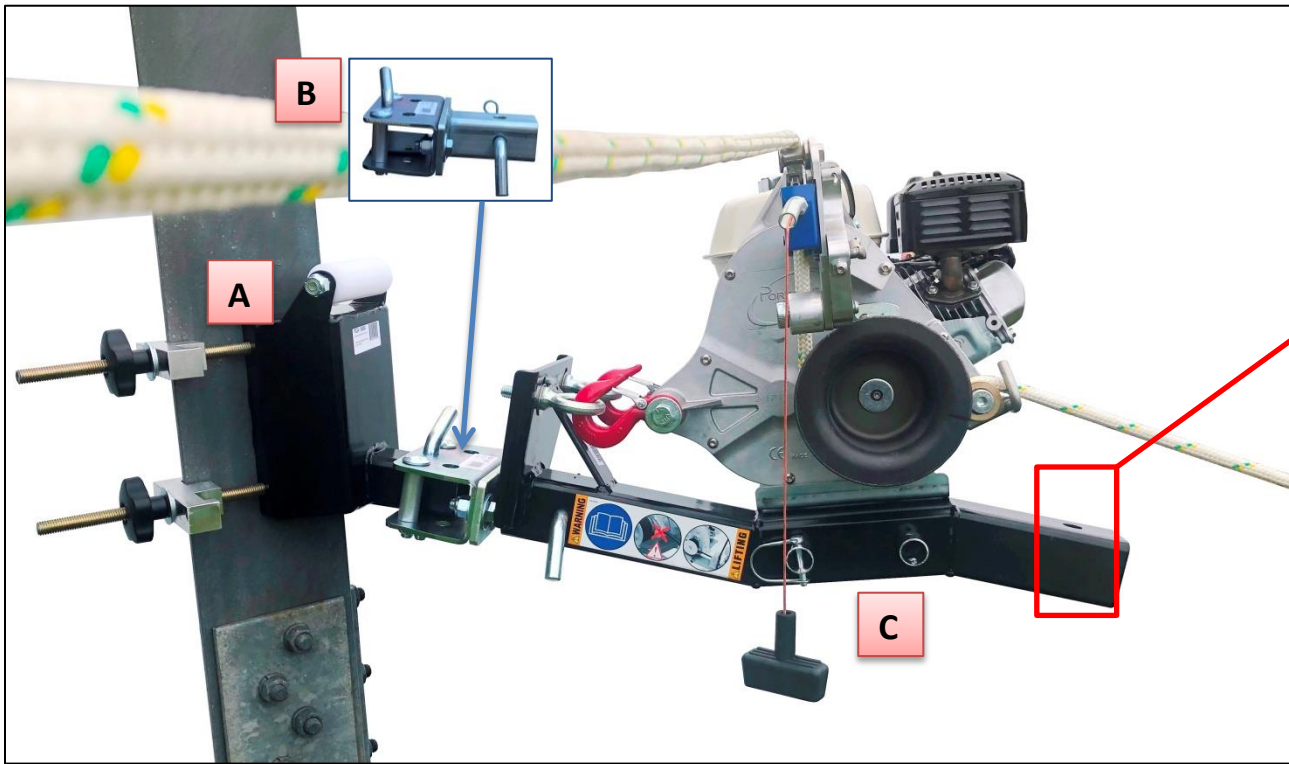
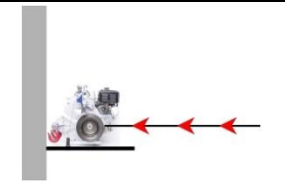

IN THIS SITUATION,  
**DO NOT USE THE REDIRECT PULLEY**  
Supplied with the  
*Winch support for vertical pulling.*

**⚠ ATTENTION** WHEN USED IN DIRECT LINE, THE PIVOTING ANCHOR FOR VERTICAL PULL SUPPORT (PCA-1332) MUST BE FIXED TO THE WINCH SUPPORT FOR VERTICAL PULL (PCA-2264). THIS ANCHOR (SOLD SEPARATELY) WILL ALLOW THE WINCH TO ALIGN WITH THE LOAD.

**⚠ ATTENTION** PUT THE ROPE ON THE WINCH ENTRY PULLEY.



# PCA-2264

## WINCH SUPPORT FOR VERTICAL PULLING

**User Manual**  
**READ CAREFULLY**



	Installation no. 5 - The winch faces the anchoring. The rope comes from the top towards the winch (vertical).		
	Accessories used		
	A	PCA-1267/1501	
B	PCA-2264	Winch support for vertical pulling	

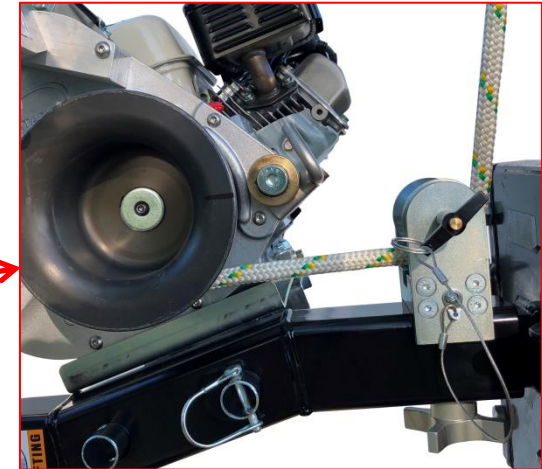
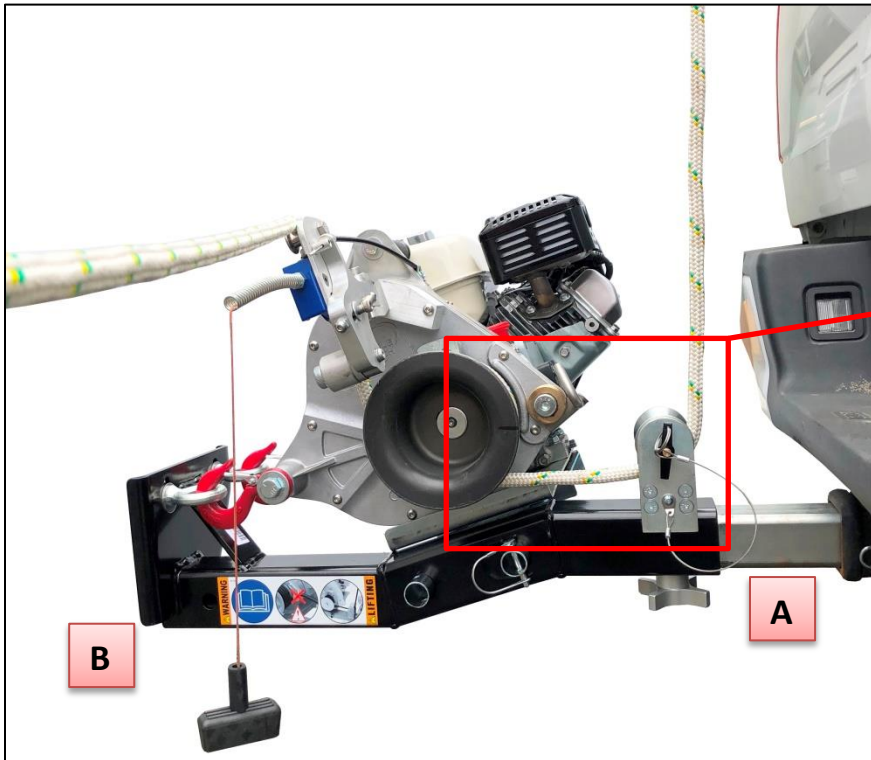

**⚠ ATTENTION** **DO NOT** GO OVER THE ROPE ENTRY PULLEY OF THE WINCH WITH THE ROPE AS IT WILL CREATE FRICTION AND WILL REDUCE LIFTING CAPACITY. **GO UNDER THE ROPE ENTRY PULLEY OF THE WINCH.** IN THIS CASE, THE ROPE ENTRY PULLEY OF THE WINCH WILL NOT BE USED.

# PCA-2264

## WINCH SUPPORT FOR VERTICAL PULLING

**User Manual**  
**READ CAREFULLY**



	Installation no. 6 - The winch faces the load. The rope is directly in line with the winch (horizontal).	
	Accessories used	
	A	PCA-1267/1501 Square tube for trailer hitch ( <b>vehicle</b> )
	B	PCA-1332 Pivoting anchor for vertical pull support
C	PCA-2264 Winch support for vertical pulling	

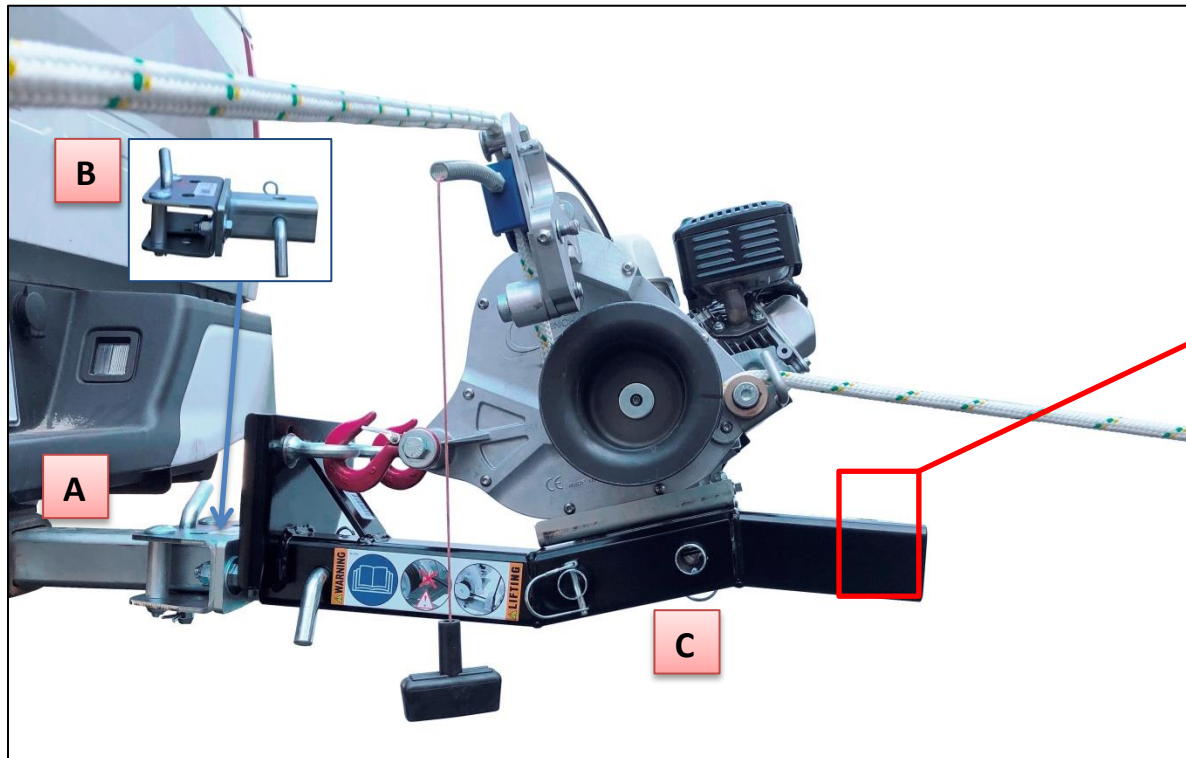
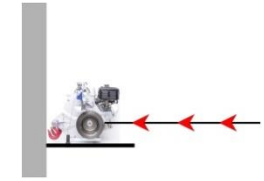

IN THIS SITUATION,  
**DO NOT USE THE REDIRECT PULLEY**  
Supplied with the  
Winch support for  
vertical pulling.

**⚠ ATTENTION** WHEN USED IN DIRECT LINE, THE PIVOTING ANCHOR FOR VERTICAL PULL SUPPORT (PCA-1332) MUST BE FIXED TO THE WINCH SUPPORT FOR VERTICAL PULL (PCA-2264). THIS ANCHOR (SOLD SEPARATELY) WILL ALLOW THE WINCH TO ALIGN WITH THE LOAD.

**⚠ ATTENTION** PUT THE ROPE ON THE WINCH ENTRY PULLEY.

# PCA-2264

## WINCH SUPPORT FOR VERTICAL PULLING

User Manual  
READ CAREFULLY

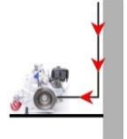

	Installation no. 7 - The winch faces the anchoring. The rope comes from the top towards the winch (vertical).		
	Accessories used		
	A	PCA-1266 Heck-Pack anchoring system with adaptor for 50 mm towing balls ( <b>vehicle</b> )	
B	PCA-2264 Winch support for vertical pulling		

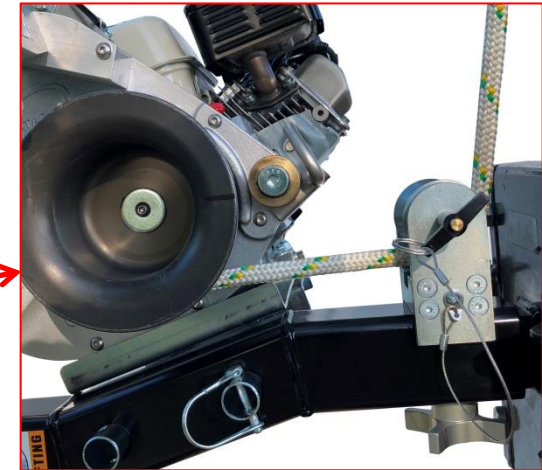
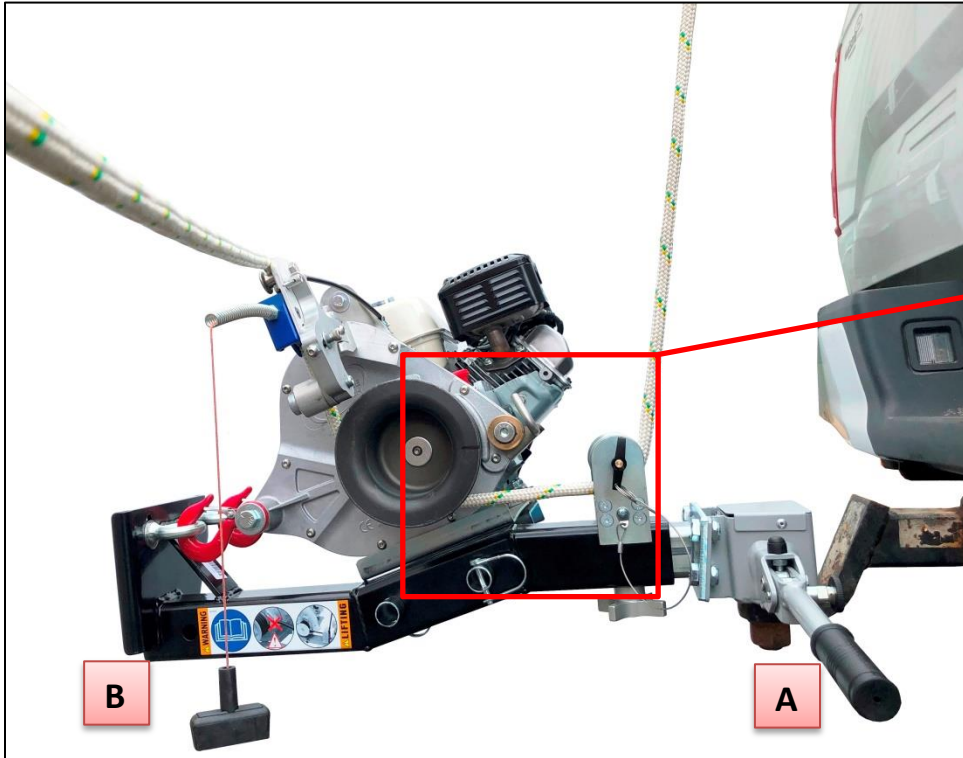

**⚠ ATTENTION** DO NOT GO OVER THE ROPE ENTRY PULLEY OF THE WINCH WITH THE ROPE AS IT WILL CREATE FRICTION AND WILL REDUCE LIFTING CAPACITY. GO UNDER THE ROPE ENTRY PULLEY OF THE WINCH. IN THIS CASE, THE ROPE ENTRY PULLEY OF THE WINCH WILL NOT BE USED.

# PCA-2264

## WINCH SUPPORT FOR VERTICAL PULLING

**User Manual**  
**READ CAREFULLY**



	Installation no. 8 - The winch faces the load. The rope is directly in line with the winch (horizontal).	
	Accessories used	
	A	PCA-1266 Heck-Pack anchoring system with adaptor for 50 mm towing balls ( <b>vehicle</b> )
	B	PCA-1332 Pivoting anchor for vertical pull support
C	PCA-2264 Winch support for vertical pulling	

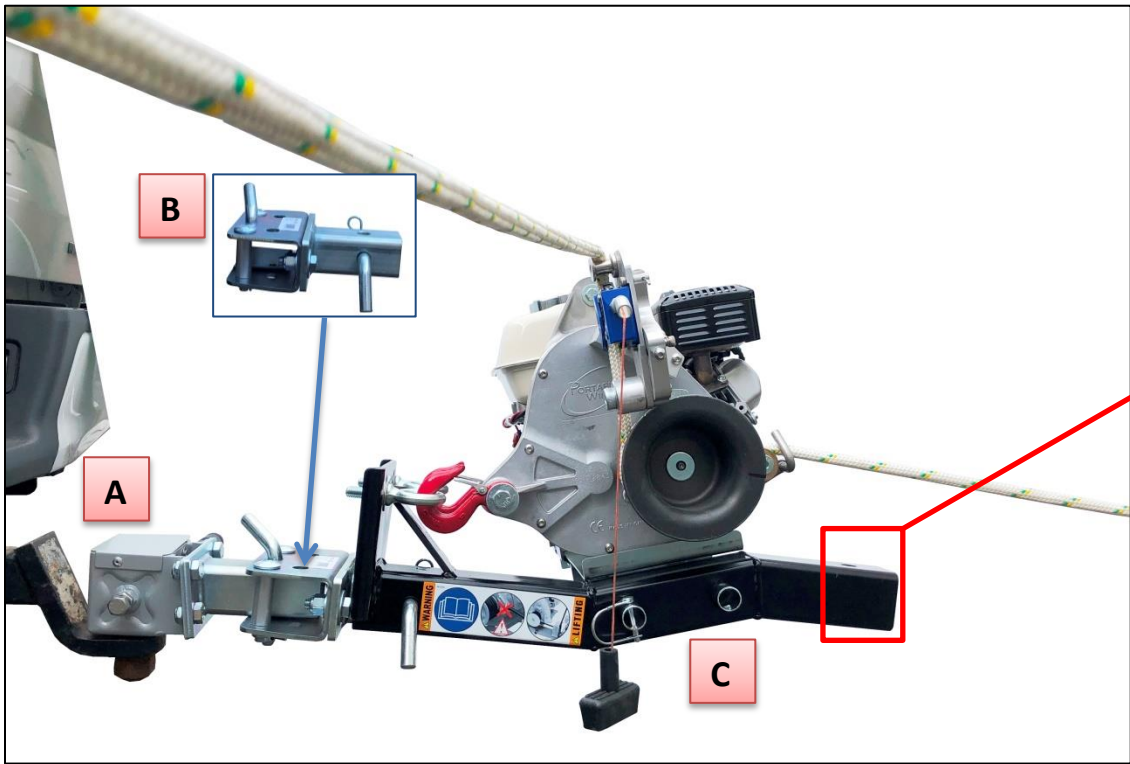
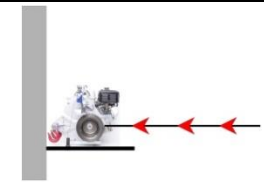

IN THIS SITUATION,  
**DO NOT USE THE REDIRECT PULLEY**  
Supplied with the  
*Winch support for vertical pulling.*

**⚠ ATTENTION** WHEN USED IN DIRECT LINE, THE PIVOTING ANCHOR FOR VERTICAL PULL SUPPORT (PCA-1332) MUST BE FIXED TO THE WINCH SUPPORT FOR VERTICAL PULL (PCA-2264). THIS ANCHOR (SOLD SEPARATELY) WILL ALLOW THE WINCH TO ALIGN WITH THE LOAD.

**⚠ ATTENTION** PUT THE ROPE ON THE WINCH ENTRY PULLEY.