



FURNITURE CATALOG 2016

**DESIGNED FOR COMFORT
AND BUILT TO LAST.**

VOLUME I

CONTENTS

EXECUTIVE CHAIRS	01
TASK CHAIRS	05
VISITOR CHAIRS	09
EXECUTIVE TABLES	11
MANAGER TABLES	19
WORKSTATIONS	27
CONFERENCE TABLES	39
COMFORTABLE SEATING	45
STORAGE FILING/CABINETS	51
LOBBY BENCHES	53
STACKING CHAIRS	55
BAR STOOLS	59
COFFEE TABLES	61
CLASSROOM FURNITURE	63
STUDY FURNITURE	65
HOSPITAL FURNITURE	67

EXECUTIVE CHAIRS



No more twisting and contorting to try to get comfortable with SPIRIT Executive Chairs! Ergonomic design with features like breathable air mesh, fixed revolving & injected lock systems, noise prevention and PU-armrest flavored with leather & stainless steel make our executive chairs meet the taste of even the most demanding CEO's to work with comfort. Correct sitting postures of our executive office chairs prevent backache and make working a fun with luxury and style!



POG-100



PM-100



MC-110



ISG-M111



MCD-110



ISG-M110



AMG-110



TMG-110



CM-B63AS



CM-B04AS



CM-B22AS



CM-B60AS



CM-F94AS



POG-100



NU-100



MA-100



RK-110

TASK CHAIRS



If you're constantly navigating your workspace - answering a call one minute while rifling through a file drawer the next - a task chair may be the solution for you. Ideally suited for busy multitaskers, task chairs include casters that provide smooth mobility and feature a low-back style that provides essential back support while accommodating movement. Don't worry, these low-back chairs don't skimp on comfort. Like their executive cousins, task chairs often feature pneumatic height adjustment along with padded seats, armrests and backrests. Thus Choose a task chair help you get the job done.





EQD-110



ME-110



MC-120



CM-43BS



AMG-120



ME-120



TM-132



CM-F80BS



PO-111



FR-101



RK-120



EV-M100



TP-121



SU-100



FO-100



CM-B32BPS

VISITOR CHAIRS



We offer a wide spectrum of visitor chairs that are highly appealing in terms of looks and comfort. These are made of the finest quality material procured after conducting stringent checks and tests. These have a comfortable sitting and have arms attached to the body. The chairs are offered in different colors and styles according to the customer's needs and specifications.



CV-B04BS



WC-1500



CV-B60BS



AM-320



CV-F80BS



MC-320



ME-320



SU-300



PATRA CHAIR

EXECUTIVE TABLES

Set a professional tone for the entire office and announce to the world that you've made it. Spirit Office Systems provide modern & contemporary executive office tables with premium quality craftsmanship surrounded with luxury. Our premier veneer desks collection are crowned with superior wood design flourished with sleek knife edged profile and mixed materials to deliver the look you desire and deserve.



BOOKCASE: 3600W x 450D x 2000H

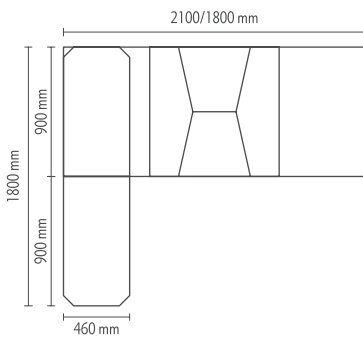

E-BONEY (DT-12)



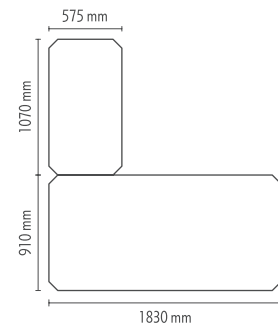
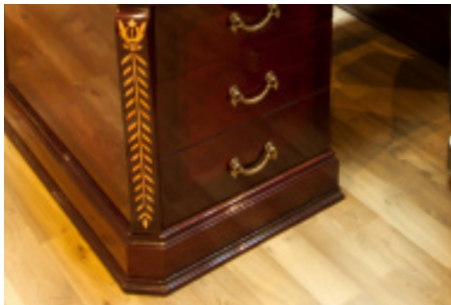

CLASSIC-01 (EPN-T015)

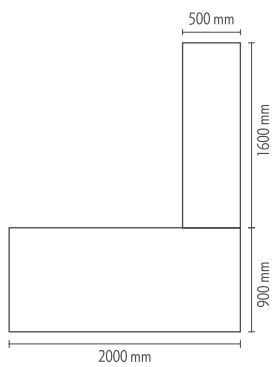

DT-03

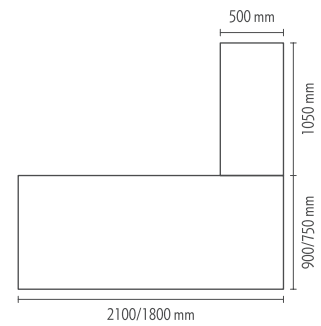

TRADITIONAL-03(CMT-015)

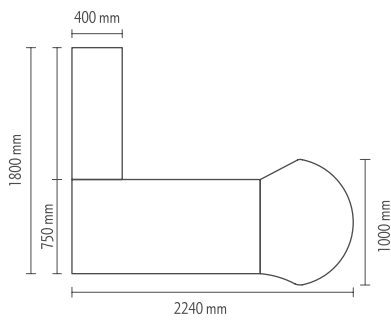

ECONO-EXTENSION

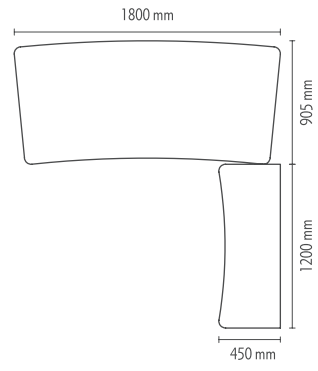

NPM-1950

MANAGER TABLES

Our Sophisticated yet luxurious managerial tables are the result of an unparalleled attention to detail and a multi-step finishing process that combines lamination and metal structures to bring you comfort and royalty hence making a strong statement about your brand. Our desire and unique ability to help our clients realize their inspiration of a Modern, conventional or traditional office furniture solution has set SPIRIT apart.

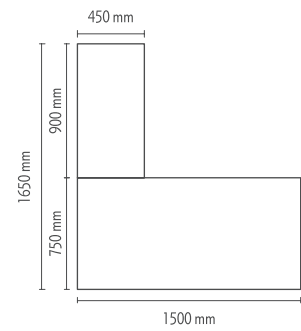

GR-1500L/R

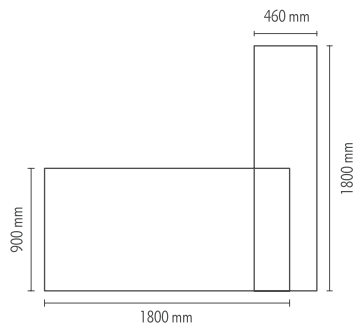

DT-14

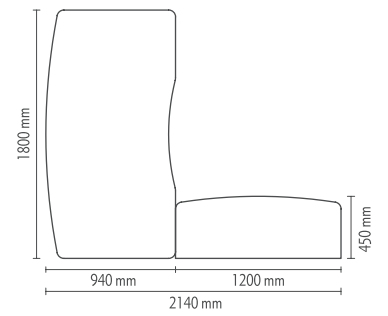

ED-760

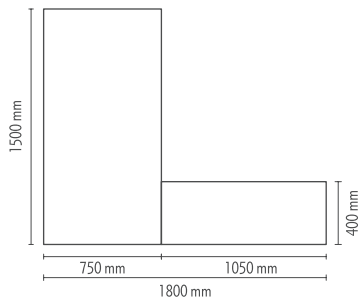

ECONO-1500

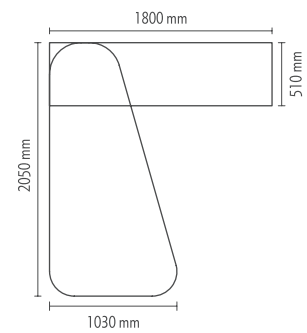
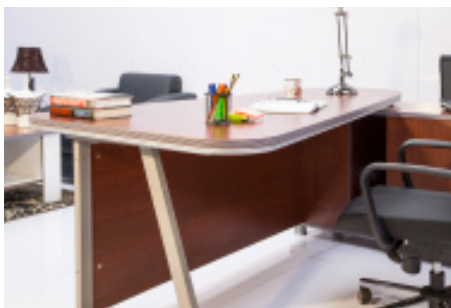

T-E-04

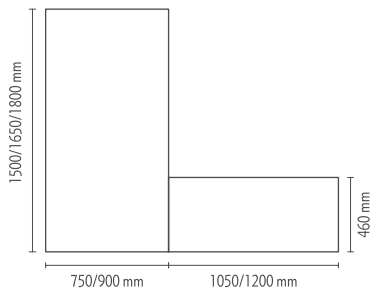

CMT-015-1(01)

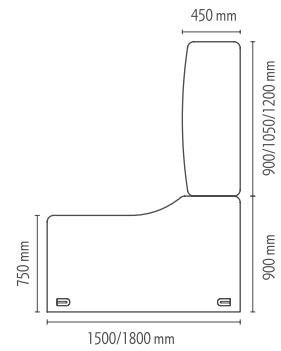

NL-1500L/R

WORK- STATIONS



With our collection of modern modular and contemporary office workstations, your workspace comes to life, inspiring creativity, enhancing productivity and collaboration throughout the day. Our customizable workstations include modern design, adjustable height sit-to-stand benching systems and office systems to customize your open office plan and optimize your space.

PLUS SERIES

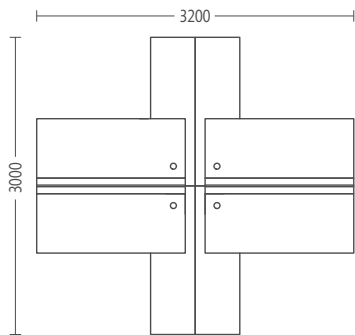

WORKSTATION

3200W x 3000D x 750H (mm)

TWS-PS-1500



PLUS SERIES (C)

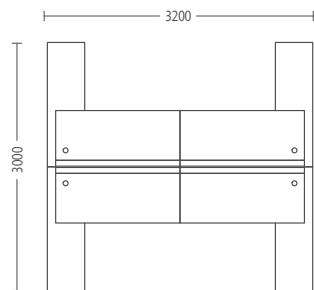

WORKSTATION

3200W x 3000D x 750H/1200H (mm)

TWS-CS-1500



CUBE SERIES



SW-P015(01)



WORKSTATION WITH & WITHOUT D CABINET
 3700W x 3000D x 1200H (mm) / 3000W x 3000D x 1200H (mm)

PLUS SERIES

Arrangement Plans

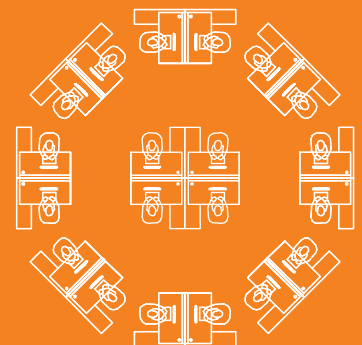
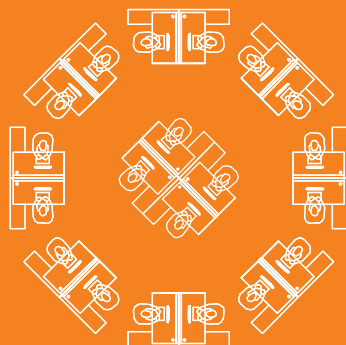
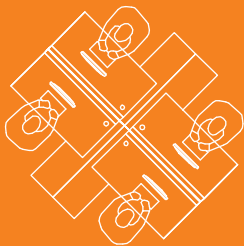
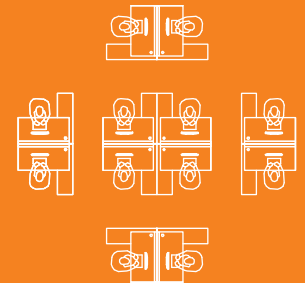
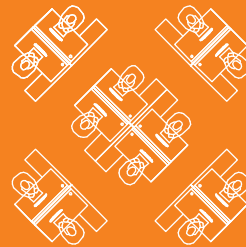
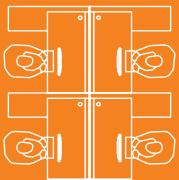
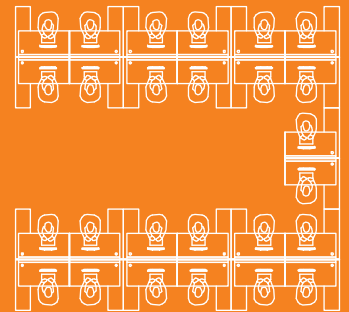
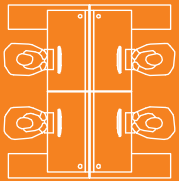
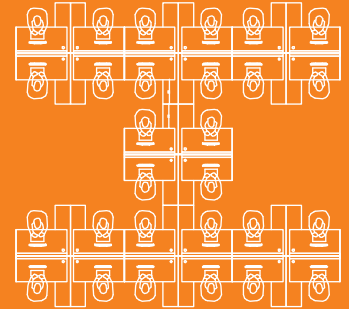
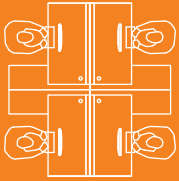

CUBE SERIES

Arrangement Plans

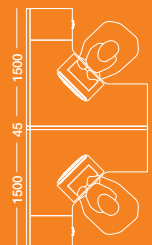
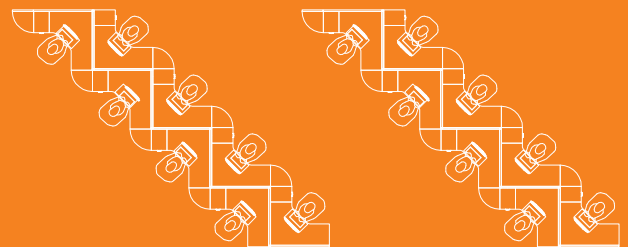
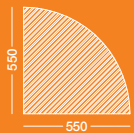
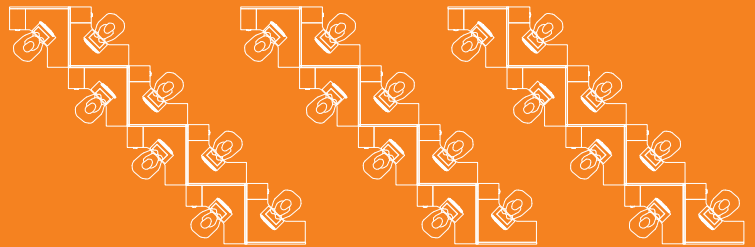
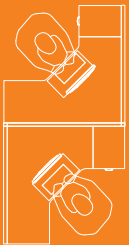
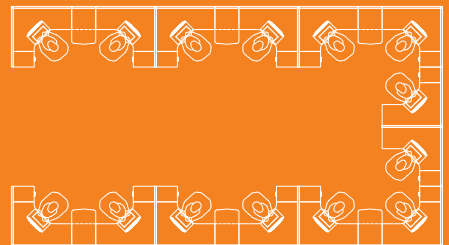
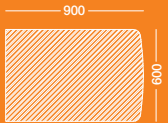
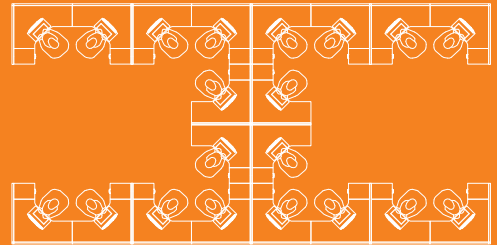
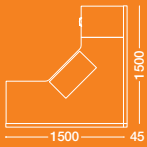

GURU STRAIGHT LINE SERIES



TOS-WS-10



WORKSTATION COLOR OPTIONS

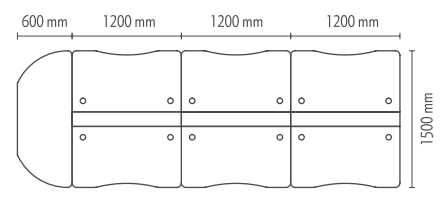
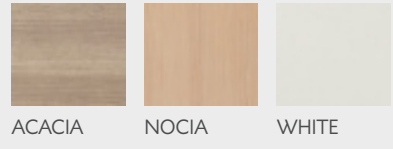

INFIX SERIES

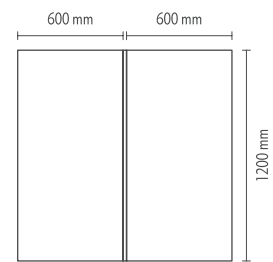
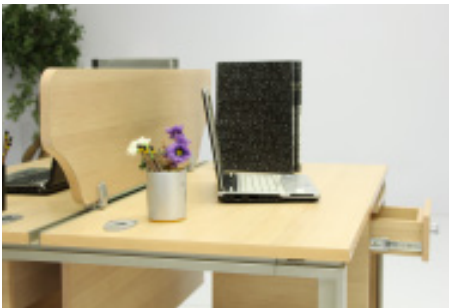

SWD-015

CONFERENCE TABLES

Maximize your productivity with Spirit's conference room solutions that urge managers to make meetings an everyday norm among their teams. Spirit conference tables offer exceptionally handsome veneer look with flexible size and elegant design to suit any meeting room. Our conference room tables are ideal for professional presentations and consultations with new clients and are built using extremely high quality material for long lasting durability and modern lifestyle.

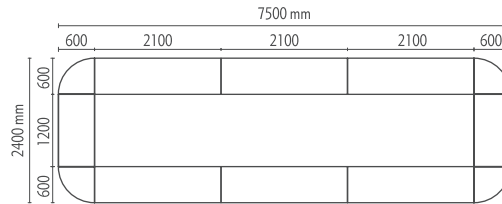
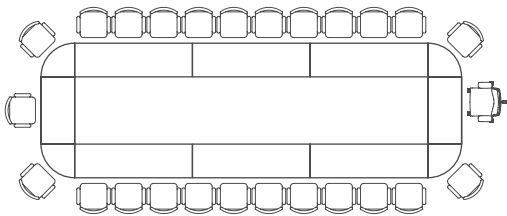

COT-016

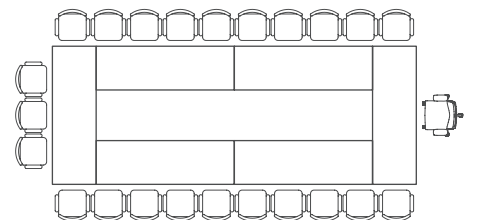
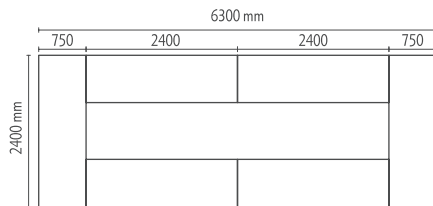

MT-015-1



COT-015

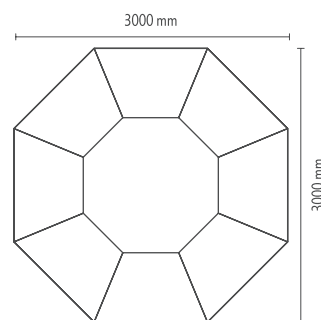
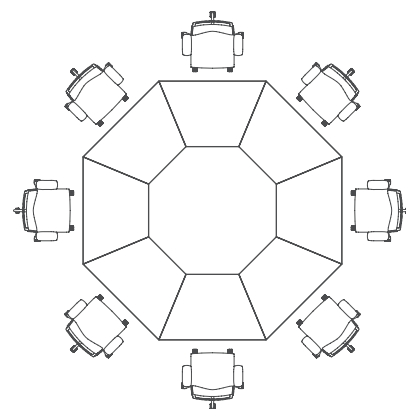

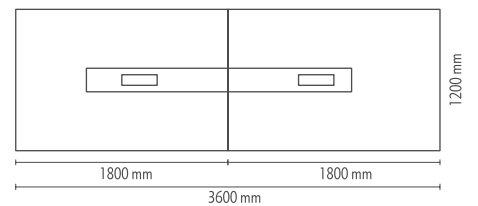
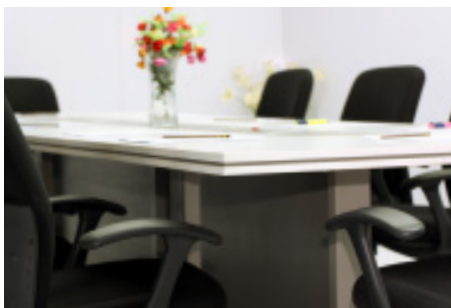

CMT-015

COMFORTABLE SEATING

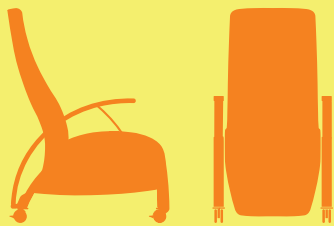

Taking time to just sit back and relax – it's one of life's simple pleasures. That's why we make soft, cozy sofas. sofas will always be a timeless piece of elegant furniture. This makes them a perfect fit with your office. Choose from our range of contemporary and modern styles.



SF-CE-01





EX-S015



1950W x 810H x 545D



1400W x 810H x 545D



850W x 810H x 545D

SHARP-1600



METRO NOVA

STORAGE FILING/ CABINETS

Selecting the right file cabinet for your home or business is the key to creating an effective method for organization and storage. Our office filing steel and wooden cabinets will add a touch of professional sophistication to your home office and provide a secure way to store important work in an arranged manner. Our Filing cabinets make it easy to access files, documents and other possessions in a way that works for you – without all the fuss.



KD904-1



OC-1600



OC-1600-1



OC-1600-2



OC-1600-3



KD901-1

LOBBY BENCHES

Benches are high capacity seating solutions that have found application in all spheres of human habitation, be it in homes, waiting rooms, lounge areas and even outdoors, though the selection here caters mostly to businesses and institutions.



WT-B015
1750W x 695D x 885H



WT-B015
35000W x 695D x 885H



HQ203S
1800W x 680D x 790H



HQ303S
1800W x 680D x 790H

STACKING CHAIRS



Our Furniture helps you make your desired statement and create the ambiance for the restaurant. It is important to maximize the number of people that can be seated in the smallest footprint possible with a mix of seating including, but not limited to, chairs, tables. The tables and chairs that you choose should be stylish and comfortable as well as durable and functional. We offer an array of restaurant furniture including stacking chairs and tables to help you develop your restaurant's style and feel. Most importantly our stacking chairs are typically easy to carry and help save space when stacked together and stored for future use.





ST-109



EF-401



ST-012



SF-CE-02



TOS-WC-09

BAR STOOLS



Bar stools are a type of tall chair, often with a foot rest to support the feet. The height and narrowness of bar stools makes them suitable for use at bars and high tables in pubs or bars. bar stools are also becoming more popular in homes, usually placed at the modern kitchen counter. Bar stools are available in varied styles. As well, bar stools allow for a higher view when eating, drinking, or socializing on a counter.



WX-2620



WX-2620



WX-2490



WX-2494

COFFEE TABLES

Explore our scenic range of coffee tables available in many colours, styles and sizes, including wooden, glass, high gloss & metal combinations.



CT-015-1



CT-015-2



CT-015



CT-015-3



CT-015-3

CLASSROOM FURNITURE

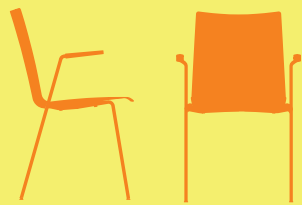

We have specially designed and developed customized education furniture for institutes to meet the everyday needs of all types of education environments, from schools to universities, art rooms, classrooms and staff areas. Being especially robust, they are also well-suited to special needs and secure unit learning establishments. We are fully equipped for the provision of education furniture range is both durable and aesthetically attractive. It offers a comprehensive variety of storage units, bookcases, worktops and sundries. We offer expert advice, short lead-times, as well as national delivery, and an installation service if required.



C1N



DN2



DN1



C3N

STUDY FURNITURE

Create a convenient workspace with study tables which add a touch of style to your home office study. You can also choose from our selection of computer & laptop tables, alongwith gorgeous bookshelf to complete your study set.



ST-001

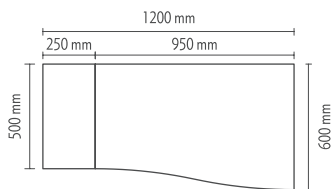

ST-002

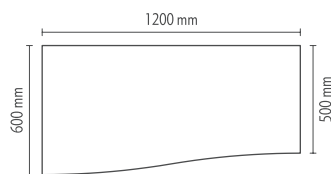

ST-003

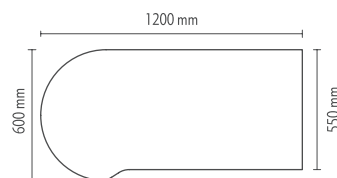

HOSPITAL FURNITURE

Our products are widely recognized for their outstanding quality. Complemented by excellent after sales service, we have successfully earned the trust and confidence of healthcare providers. Our continuous improvement philosophy with customers in mind has allowed us to set numerous industry benchmarks in term of quality, innovation and customer satisfaction.

We will continue to strive to become preferred healthcare partner, in terms of provision of comprehensive solutions for Furniture to healthcare institutes.



H-SU-01



H-BNH-01



H-SU-02



H-CRD-01

HEAD OFFICE & DISPLAY CENTER

60-B Block, BI Gulberg III Lahore
UAN (042) 111 186 724
T 042 35760481-2 F 042 35760485
sales@torch.com.pk

ISLAMABAD OFFICE & DISPLAY CENTER

Plot 29, Sanitary Market I-11/3 Islamabad
T 051 4863971 F 051 4863972
isb@torch.com.pk

FACTORY

113/11 Quaid-e-Azam Industrial Estate Lahore
T 042 35213595-96

www.torch.com.pk



Find us on 