



Catalog Number:	
Project:	
Comments:	
Prepared By:	Date:

Description

The sleek fixture design of the LDS-LAL is a blend of modern sophistication and unmatched energy efficiency. The LDS-LAL Large area light includes the benefits of superior thermal efficiency, an industry-leading ten-year all-parts warranty, and custom optics ensuring best-in-class photometric results. Optimize photometric designs with greater pole spacing, uniformity, and lower energy usage. The LDS-LAL includes lumen packages up to 50,000 lumens allowing one-for-one replacements of existing HID fixtures up to 1000 Watt, and is a perfect spec-grade solution for parking lots, pathways, tennis courts, and many other outdoor applications. Proudly Made in the USA.

Dimensions & Weights

Model	Width	Length	Height	Weight
LDS-LAL	15.56"	32.19"	5.48" (MAS) 10.74" (SF)	34.5 lbs

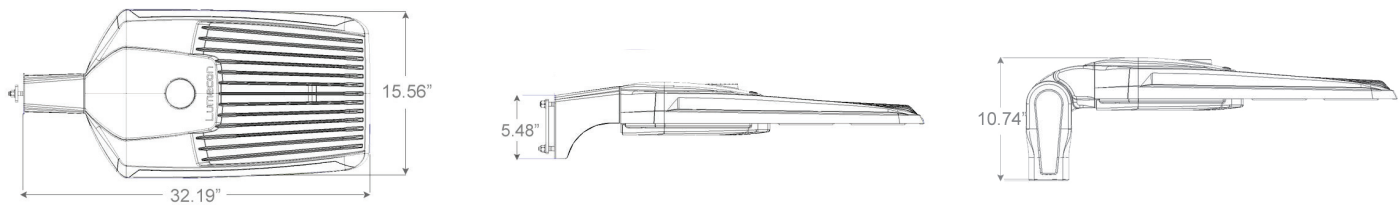

Technical Specifications

Input Voltage: 120-277V or 347-480V.

Housing: Die-cast aluminum housing with 60% gloss polyester powder coat finishes for maximum durability. The base aluminum material is prepared using an environmentally-friendly non-chrome 2-step surface cleaning and passivation process. The process results in a more durable conversion layer than traditional chromate conversion coatings and allows maximum adhesion of the powder coating to the aluminum substrate. Housing features an integrated heat sink and driver compartment built into the fixture design.

Mounting: Mounting arm designed for a square pole (standard). Additional mounting options include a pole mounting arm adaptor.

Split Circuit: Standard except on the 165W model.

Effective Projected Area (EPA): 1.05 ft²

Color Temperature: 2200K, 2700K, 3000K, 4000K (standard), 5000K.

LED Lifetime: All LEDs are rated for a minimum of 100,000 hours of continuous operation at ambient outdoor temperatures from -40°F/-40°C to 115°F/46°C.

Color Rendering Index (CRI): Minimum of 70 or higher. CRI 80+ available upon request. CRI 90+ not available in 2200K.

Dimming: 0-10V standard dimming capability.

Custom Optics: Lumecon meticulously engineered premium acrylic optical lenses to maximize the distribution and uniformity of light while minimizing cost. Our arrays distribute light at least 21% further and with 29% more uniformity than leading competitors. Lumecon custom lenses create a uniform, well-lit environment that mitigates illuminance "hot spots" and use less wattage than typical LED area lights.

Vandal Resistant: Our lens is also resistant to vandalism with a low compact design making the lens material dense and impact resistant. We build to withstand high abuse lighting environments.

Surge Protection: Thermally protected 40kV varistor type surge suppressor is included and meets ANSI C136.2-2015: Extreme Level. Also meets IEC61643-11 Class II / EN61643-11 Type 2, and US Dept of Energy MSSLC Model Spec for surge protection. The device is wired in series with the luminaire input power in order to interrupt power to the luminaire when consumed, protecting the LED power supply and circuit boards from additional electrical surges.

Lumecon ETD™ System: The enhanced thermal dissipation system engines are thermally bonded to provide maximum thermal dissipation to the exterior of the fixture to ensure long life. To protect the light engine panel from moisture and corrosion, the LED light engine panel is uniformly coated with a UV stabilized acrylic polymer resin that meets MIL and ASTM dielectric standards, UL, and IPC standards for flammability, moisture resistance and thermal shock.

Certification Data: ETL Listed to UL 1598, UL 8750 for Wet Locations. *Full compliance and test documentation is available for TM-21, LM-79, LM-80, ETL Listing to UL1598 and UL 8750. Salt Fog tested for 3,000 hours per ASTM B117-16 / ASTM D610-08. Ingress Protection: IP66 per ANSI/IEC 60529-2004. Passed 3G vibration @ 100K cycles, per ANSI C136.31-2018.

DesignLights Consortium® (DLC) Qualified Product: Unless noted, not all versions of this product may be DLC® qualified. For a complete list of Lumecon DLC® Qualified Products visit: www.designlights.org.

Dimulator Photo-Control: Maximize the cost-saving benefits of your outdoor LED light fixtures with the stand-alone Dimming solution. All Dimulators (except for CD and DIM 3 versions) have three selectable dimming levels (30%, 50%, 70%) with three different start times (10:00 pm, Midnight, or 2:00 am), which are selectable through the ten position selector switch located on the bottom of the base. All dimming schedules will return to full brightness at 5:00 am. The stand-alone unit is made to work with the ANSI C136.41 receptacle and will provide dimming of LED fixtures.

Manufacturing Origin: US Manufactured and Assembled.

BABA Compliant: Meets Build America, Buy America Act Included in the Infrastructure Investment and Jobs Act, Public Law Number 117-58, Title IX, Subtitle A, Part I – Buy America Sourcing Requirements, Sections 70911-70917 stating Manufactured in the U.S. The cost of components mined, produced, or manufactured in the U.S. is greater than 55 percent of the total cost of all manufactured product components.

Warranty: 10 Year L70 performance based warranty. For full warranty terms, please visit our website: www.lumecon.com



Ordering Information

LDS-LAL – Options / Ordering Example: LDS-LAL-200-DB-T5-1-NW-70-MAS

Wattage	Color	Distribution	Voltage	Color Temperature	CRI	Mounting Methods
165 - 165 Watts	DB - Dark Bronze	T2 - Type II	1 - 120v-277v	22 - 2200K	70 - 70 CRI	MAS - Mounting Arm (Square Pole) ⁵
200 - 200 Watts	WH - White	T3 - Type III	2 - 347v-480v	WW - 2700K ⁵	80 - 80 CRI	<i>For a Round pole, add UARP option</i>
250 - 250 Watts	BK - Black	T4 - Type IV		OW - 3000K ⁵	90 - 90 CRI	SF - Slip Fitter
275 - 275 Watts	GR - Gray	T5 - Type V		NW - 4000K		TM - Tenon Mount ⁵
300 - 300 Watts	CC - Custom Color			CW - 5000K		
330 - 330 Watts	AF - Automotive Finish					

Options & Accessories

- UARP - Universal Adaptor Round Pole
- R - Receptacle Only
- RS - Receptacle Only with Shorting Cap
- 7P - Seven-pin Twist Lock Photocell Receptacle Only ¹
- PC1 - 120v-277v Button Eye Photocell ²
- PC2 - 347v-480v Button Eye Photocell ²
- PC3 - 120v-277v Twist Lock Photocell (10 year warranty)
- PC4 - 347v-480v Twist Lock Photocell (10 year warranty)
- OC1 - On/Off Occupancy Sensor ³
- OC2 - Dim/High Occupancy Sensor ^{3,4}
- OC3 - On/Off Occupancy Sensor w/Photocell ³
- OC4 - Dim/High Occupancy Sensor w/Photocell ^{3,4}
- SC - Split Circuit (Standard except on the 165W model)
- DIM4 - 105-305 VAC, 50/60 Hz with 10 position field adjustable selector switch
- DIM4-HV - High Voltage 312-530 VAC, 50/60 Hz with 10 position field adjustable selector switch
- DIM4-CD - Constant all-night Dimming
- DIM4-CD-HV - Constant all-night Dimming, 315-530 VAC 50/60Hz
- DIM4-CUL - 120 VAC. 50/60 Hz, cUL certified version with gray cover
- DIM4-ALC - Adaptive Lighting Control with 2% per year incremental increase to compensate for aging fixture
- DIM3-XX - Factory set dimming schedule (10 position selector switch not available)
- BS5 - Bird Spikes (Field Installed)
- BL - Backlight Louver(s) snap over LED Array(s) for Backlight Control at the source.⁶

Accessories ordered as a separate line item:

- 33-00111 - External Glare Shield
- 33-00119 - Full Glare Shout

Notes:

1. For units with 7P the mounting must be restricted to +/-45° from horizontal aim per ANSI C1136.10-2010. If more than a 45° Tilt, use PC1 or PC2
2. Cannot be combined with Occupancy Sensor. Use OC3 or OC4 when Occupancy Sensor and Photocell are needed and aiming greater than 45° from horizontal.
3. Must note on PO Mounting Height for proper lens application
4. See Occupancy Sensor Default Settings Table
5. 3000K or warmer, and fixed mounts must be ordered for IDA certification compliance
6. Works with Type 2, Type 3 and Type 4 arrays.

Color Option Samples

Due to variations in monitor settings and color printing settings, colors will not be exact.



If OCC Sensor Option is selected, mounting height specifications need to be clarified: Mounting height between 0' - 10'

If Mounting height and parameter settings not specified when ordered. Default mounting height is 10-40' lens and preset factory settings. Mounting height between 10' - 20'

Mounting height over 20'+

OCC Sensor Patterns

0' - 10' Mounting Height

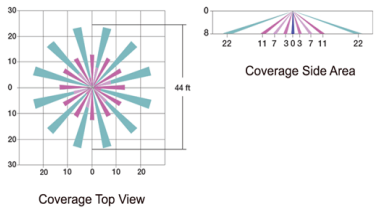

10' - 40' Mounting Height

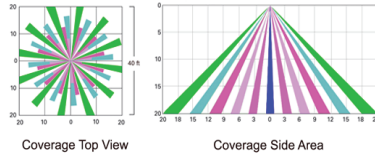

40' + Mounting Height

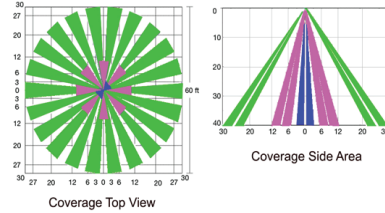

Occupancy Sensor Default Settings - Option OC2

Option	Dimmed State (Unoccupied)	High Level (When occupied)	Photocell Operation (OC4 Option Only*)	Dwell Time (Occupancy time delay)	Ramp-up Time (From unoccupied to occupied)	Ramp-up Time (From occupied to unoccupied)
OC2 and OC4	Approx. 20% Output	100% Output	Enabled @ 1.5 FC*	5 Minutes	Disabled	Disabled

*Note: OC2 and OC4 settings including photocell set point, high/low dim rates, and occupancy sensor time delay are all configurable by using the Wattstopper® App. If any other settings are desired to be set at the factory, please note these changes on Purchase Order.

Performance Data

Model	Distribution Type	Watts	2200K					2700K					3000K					4000K					5000K				
			Lumens	B	U	G	Efficacy	Lumens	B	U	G	Efficacy	Lumens	B	U	G	Efficacy	Lumens	B	U	G	Efficacy	Lumens	B	U	G	Efficacy
LDS-LAL-165	Type 2	165W	20,701	3	0	3	127	23,796	3	0	3	146	25,492	3	0	3	156	26,496	3	0	3	162	26,496	3	0	3	162
	Type 3	165W	20,504	3	0	3	126	23,569	3	0	3	145	25,249	3	0	3	155	26,239	3	0	3	161	26,251	3	0	3	161
	Type 4	165W	19,794	3	0	4	123	23,174	3	0	4	144	24,923	3	0	4	154	26,118	3	0	4	160	26,127	3	0	4	160
	Type 5	165W	20,359	5	0	3	126	23,406	5	0	3	145	25,258	5	0	3	156	26,249	5	0	3	162	26,260	5	0	3	162
LDS-LAL-200	Type 2	200W	24,317	4	0	4	122	27,952	4	0	4	140	29,945	4	0	4	150	31,114	4	0	4	156	31,133	4	0	4	156
	Type 3	200W	24,137	4	0	4	121	27,745	4	0	4	139	29,723	4	0	4	149	30,883	4	0	4	155	30,902	4	0	4	155
	Type 4	200W	23,972	4	0	4	120	27,555	4	0	4	138	29,519	4	0	4	148	30,672	4	0	4	153	30,691	4	0	4	154
	Type 5	200W	24,257	5	0	4	121	27,883	5	0	4	140	29,871	5	0	4	149	31,035	5	0	4	155	31,056	5	0	4	155
LDS-LAL-250	Type 2	242W	28,741	4	0	4	119	33,037	4	0	4	136	35,392	4	0	4	146	36,773	4	0	4	152	36,796	4	0	4	152
	Type 3	242W	28,528	4	0	4	118	32,792	4	0	4	135	35,130	4	0	4	145	36,501	4	0	4	151	36,524	4	0	4	151
	Type 4	242W	28,333	4	0	4	117	32,569	4	0	4	134	34,889	4	0	4	144	36,251	4	0	4	150	36,274	4	0	4	150
	Type 5	242W	28,670	5	0	4	118	32,955	5	0	4	136	35,305	5	0	4	146	36,670	5	0	4	151	36,705	5	0	4	151
LDS-LAL-275	Type 2	276W	31,682	4	0	4	115	36,418	4	0	4	132	39,014	4	0	4	141	40,537	4	0	4	147	40,562	4	0	4	147
	Type 3	276W	31,447	4	0	4	114	36,147	4	0	4	131	38,725	4	0	4	140	40,236	4	0	4	146	40,261	4	0	4	146
	Type 4	276W	31,232	4	0	4	113	35,901	4	0	4	130	38,460	4	0	4	139	39,961	4	0	4	145	39,986	4	0	4	145
	Type 5	276W	31,604	5	0	4	115	36,329	5	0	4	132	38,917	5	0	4	141	40,443	5	0	4	147	40,462	5	0	4	147
LDS-LAL-300	Type 2	293W	33,128	4	0	4	113	38,080	4	0	4	130	40,794	4	0	4	139	42,386	4	0	4	145	42,413	4	0	4	145
	Type 3	293W	32,882	4	0	4	112	37,797	4	0	4	129	40,492	4	0	4	138	42,072	4	0	4	144	42,098	4	0	4	144
	Type 4	293W	32,657	4	0	4	112	37,539	4	0	4	128	40,215	4	0	4	137	41,785	4	0	4	143	41,810	4	0	4	143
	Type 5	293W	33,046	5	0	4	113	37,985	5	0	4	130	40,693	5	0	4	139	42,280	5	0	4	144	42,308	5	0	4	144
LDS-LAL-330	Type 2	332W	35,670	4	0	4	108	42,558	4	0	4	129	45,592	4	0	4	137	47,371	4	0	4	143	47,401	4	0	4	143
	Type 3	332W	34,708	4	0	4	105	41,410	4	0	4	125	43,668	4	0	4	132	46,089	4	0	4	139	46,126	4	0	4	139
	Type 4	330W	33,491	4	0	5	105	40,874	4	0	5	123	43,084	4	0	5	131	45,194	4	0	5	137	45,216	4	0	5	137
	Type 5	331W	33,538	5	0	5	107	42,453	5	0	5	128	44,697	5	0	5	135	47,051	5	0	5	143	47,180	5	0	5	142

Mounting Method Dimensions

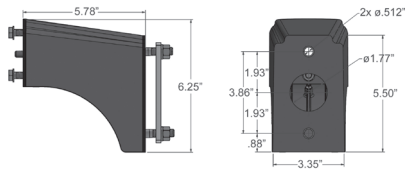

MAS - Square Pole Arm Dimensions

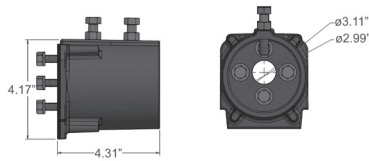

TM - Tenon Arm Dimensions

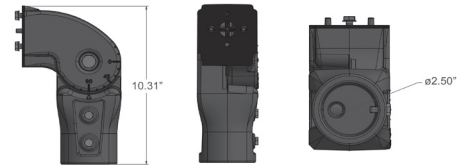

SF - Slip Fitter Arm Dimensions

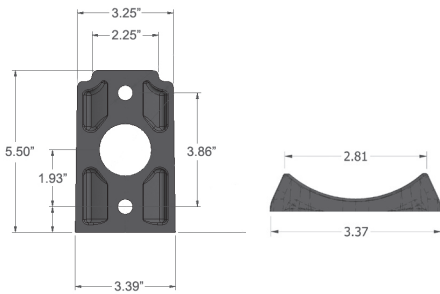

UARP - Universal Adaptor Round Pole

External Glare Shield and Full Glare Snoot Dimensions

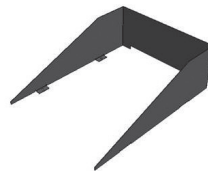
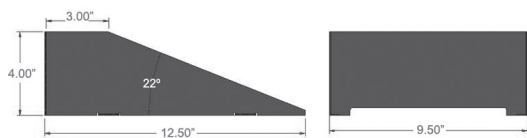

Field Installed for Forward Glare Reduction



Field Installed for Rear Glare Reduction

33-00111 – External Glare Shield



33-00119 – Full Glare Snoot

Backlight Louver(s)

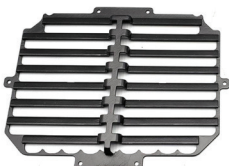

BL - Backlight Louver(s) snap over LED Array(s) for Backlight Control at the source.
Works with Type 2, Type 3 and Type 4 arrays.

Performance Data

Electrical Load Data

Fixture Model	Drive Current (mA)	System Watts (W)	AC Current Load (A)				
			120V	208V	240V	277V	480V
LDS-LAL-165	1450	165	1.53	0.88	0.76	0.66	0.38
LDS-LAL-200	910	200	1.85	1.07	0.93	0.80	0.46
LDS-LAL-250	1100	250	2.31	1.34	1.16	1.00	0.58
LDS-LAL-275	1250	275	2.55	1.47	1.27	1.10	0.64
LDS-LAL-300	1325	300	2.78	1.60	1.39	1.20	0.69
LDS-LAL-330	1475	330	3.06	1.76	1.53	1.32	0.76

Lumen Maintenance

Data in the table below references projected performance in a 25°C ambient and is based on 10,000 hours of LED testing. Performance data has been tested per IESNA LM-80-08 and projected per IESNA TM-21-11.

Use the lumen maintenance factor that corresponds to the desired number of operating hours below to calculate LLF.

Fixture Model	Lumen Maintenance Factors @ 25°C, by hours:				
	0	25,000	50,000	70,000	100,000
LDS-LAL-165	1.0	0.99	0.994	0.989	0.983
LDS-LAL-200	1.0	0.99	0.994	0.989	0.983
LDS-LAL-250	1.0	0.99	0.994	0.989	0.983
LDS-LAL-275	1.0	0.99	0.994	0.989	0.983
LDS-LAL-300	1.0	0.99	0.994	0.989	0.983
LDS-LAL-330	1.0	0.99	0.994	0.989	0.983



Catalog Number:	
Project:	
Comments:	
Prepared By:	Date:

Description

The sleek fixture design of the LDS-SAL is a blend of modern sophistication and unmatched energy efficiency. The LDS-SAL small area light includes the benefits of superior thermal efficiency, an industry-leading ten-year all-parts warranty, and custom optics ensuring best-in-class photometric results. Optimize photometric designs with greater pole spacing, uniformity, and lower energy usage. The LDS-SAL includes lumen packages up to 30,000 lumens allowing one-for-one replacements of existing HID fixtures up to 1000 Watt and is a perfect spec-grade solution for parking lots, pathways, tennis courts, and many other outdoor applications. Proudly Made in the USA.

Technical Specifications

Input Voltage: 120-277V or 347-480V.

Housing: Die-cast aluminum housing with 60% gloss polyester powder coat finishes for maximum durability. The base aluminum material is prepared using an environmentally-friendly non-chrome 2-step surface cleaning and passivation process. The process results in a more durable conversion layer than traditional chromate conversion coatings and allows maximum adhesion of the powder coating to the aluminum substrate. Housing features an integrated heat sink and driver compartment built into the fixture design.

Mounting: Mounting arm designed for a square / round pole (standard). Additional mounting options include a pole mounting arm adaptor.

Split Circuit: Optional

Effective Projected Area (EPA): 0.83 ft²

Color Temperature: 2200K, 2700K, 3000K, 4000K (standard), 5000K.

LED Lifetime: All LEDs are rated for a minimum of 100,000 hours of continuous operation at ambient outdoor temperatures from -40°F/-40°C to 115°F/46°C.

Color Rendering Index (CRI): Minimum of 80 or higher. CRI 90+ available upon request. CRI 90+ not available in 2200K.

Dimming: 0-10V standard dimming capability.

Custom Optics: Lumecon meticulously engineered premium acrylic optical lenses to maximize the distribution and uniformity of light while minimizing cost. Our arrays distribute light at least 21% further and with 29% more uniformity than leading competitors. Lumecon custom lenses create a uniform, well-lit environment that mitigates illuminance "hot spots" and use less wattage than typical LED area lights.

Vandal Resistant: Our lens is also resistant to vandalism with a low compact design making the lens material dense and impact resistant. We build to withstand high abuse lighting environments.

Surge Protection: Thermally protected 20kA/ 40kV varistor type surge suppressor is included and meets ANSI C136.2-2015: Extreme Level. Also meets IEC61643-11 Class II / EN61643-11 Type 2, and US Dept of Energy MSSLC Model Spec for surge protection. The device is wired in series with the luminaire input power in order to interrupt power to the luminaire when consumed, protecting the LED power supply and circuit boards from additional electrical surges.

Lumecon ETD™ System: The enhanced thermal dissipation system engines are thermally bonded to provide maximum thermal dissipation to the exterior of the fixture to ensure long life. To protect the light engine panel from moisture and corrosion, the LED light engine panel is uniformly coated with a UV stabilized acrylic polymer resin that meets MIL and ASTM dielectric standards, UL, and IPC standards for flammability, moisture resistance and thermal shock.

Certification Data: ETL Listed to UL 1598, UL 8750 Wet Locations. *Full compliance and test documentation is available for TM-21, LM-79, LM-80, ETL Listing to UL1598 and UL 8750. Salt Fog tested for 3,000 hours per ASTM B117-16 / ASTM D610-08. Ingress Protection: IP66 per ANSI/IEC 60529-2004. Passed 3G vibration @ 100K cycles, per ANSI C136.31-2018.

DesignLights Consortium® (DLC) Qualified Product: Unless noted, not all versions of this product may be DLC® qualified. For a complete list of Lumecon DLC® Qualified Products visit: www.designlights.org.

Dimulator Photo-Control: Maximize the cost-saving benefits of your outdoor LED light fixtures with the stand-alone Dimming solution. All Dimulators (except for CD and DIM 3 versions) have three selectable dimming levels (30%, 50%, 70%) with three different start times (10:00 pm, Midnight, or 2:00 am), which are selectable through the ten position selector switch located on the bottom of the base. All dimming schedules will return to full brightness at 5:00 am. The stand-alone unit is made to work with the ANSI C136.41 receptacle and will provide dimming of LED fixtures.

Manufacturing Origin: US Manufactured and Assembled.

BABA Compliant: Meets Build America, Buy America Act Included in the Infrastructure Investment and Jobs Act, Public Law Number 117-58, Title IX, Subtitle A, Part I – Buy America Sourcing Requirements, Sections 70911-70917 stating Manufactured in the U.S. The cost of components mined, produced, or manufactured in the U.S. is greater than 55 percent of the total cost of all manufactured product components.

Warranty: 10 Year L70 performance based warranty. For full warranty terms, please visit our website: www.lumecon.com

Ordering Information

LDS-SAL – Options / Ordering Example: LDS-SAL-110-DB-T5-1-50-MAS

Wattage	Color	Distribution	Voltage	Color Temperature	Mounting Methods
30 - 30 Watts	DB - Dark Bronze	T2 - Type II	1 - 120v-277v	22 - 2200K ⁸	MAS - Mounting Arm (Square Pole) ⁸ <i>For a Round pole, add UARP option</i>
45 - 45 Watts	GR - Gray	T3 - Type III	2 - 347v-480v	27 - 2700K ⁸	SF - Slip Fitter
60 - 60 Watts	BK - Black	T4 - Type IV		30 - 3000K ⁸	TM - Tenon Mount ⁸
75 - 75 Watts	WH - White	T5 - Type V		40 - 4000K	
80 - 80 Watts	CC - Custom Color			50 - 5000K	
85 - 85 Watts	AF - Automotive Finish				
95 - 95 Watts					
110 - 110 Watts					
125 - 125 Watts					
160 - 160 Watts					
200 - 200 Watts					
220 - 220 Watts					

Options & Accessories

UARP - Universal Adaptor Round Pole

R - Receptacle Only

RS - Receptacle Only with Shorting Cap

7P - Seven-pin Twist Lock Photocell Receptacle Only ¹

PC1 - 120v-277v Button Eye Photocell ²

PC2 - 347v-480v Button Eye Photocell ²

PC3 - 120v-277v Twist Lock Photocell (10 year warranty)

PC4 - 347v-480v Twist Lock Photocell (10 year warranty)

OC1 - On/Off ³

OC2 - Dim/High ^{3,4}

OC3 - On/Off w/Photocell ³

OC4 - Dim/High w/Photocell ^{3,4}

SC - Split Circuit ^{5,6,7}

BB - Battery Back-Up (only available on the 30W - 80W models and on 120/277V models)

BBCR - Battery Back-Up Cold Rated (only available on the 30W - 80W models and on 120/277v models)

DIM4 - 105-305 VAC, 50/60 Hz with 10 position field adjustable selector switch

DIM4-HV - High Voltage 312-530 VAC, 50/60 Hz with 10 position field adjustable selector switch

DIM4-CD - Constant all-night Dimming

DIM4-CD-HV - Constant all-night Dimming, 315-530 VAC 50/60Hz

DIM4-CUL - 120 VAC. 50/60 Hz, cUL certified version with gray cover

DIM4-ALC - Adaptive Lighting Control with 2% per year incremental increase to compensate for aging fixture

DIM3-XX - Factory set dimming schedule (10 position selector switch not available)

BS5 - Bird Spikes (Field Installed)

BL - Backlight Louver(s) snap over LED Array(s) for Backlight Control at the source. ⁹
Accessories ordered as a separate line item:

33-00112 - External Glare Shield

33-00120 - Full Glare Snoot

Notes:

- For units with 7P the mounting must be restricted to +/-45° from horizontal aim per ANSI C1136.10-2010. If more than a 45° Tilt, use PC1 or PC2
- Cannot be combined with Occupancy Sensor. Use OC3 or OC4 when Occupancy Sensor and Photocell are needed and aiming greater than 45° from horizontal.
- Must note on PO Mounting Height for proper lens application
- See Occupancy Sensor Default Settings Table
- Split circuit is only available for 30W, 45W, 60W, and 80W models.
- Split circuit is not compatible with Occupancy sensing our photo-eye control.
- Split Circuit and Battery Back-up cannot both fit in the same housing. Battery Back-Up will require external. Battery Backup will only control one of the circuits.
- 3000K or warmer, and fixed mounts must be ordered for IDA certification compliance.
- Works with Type 2, Type 3 and Type 4 arrays.

If OCC Sensor Option is selected, mounting height specifications need to be clarified:

- Mounting height between 0' - 10'
- Mounting height between 10' - 20'
- Mounting height over 20'+

If Mounting height and parameter settings not specified when ordered. Default mounting height is 10-40' lens and preset factory settings.

OCC Sensor Patterns

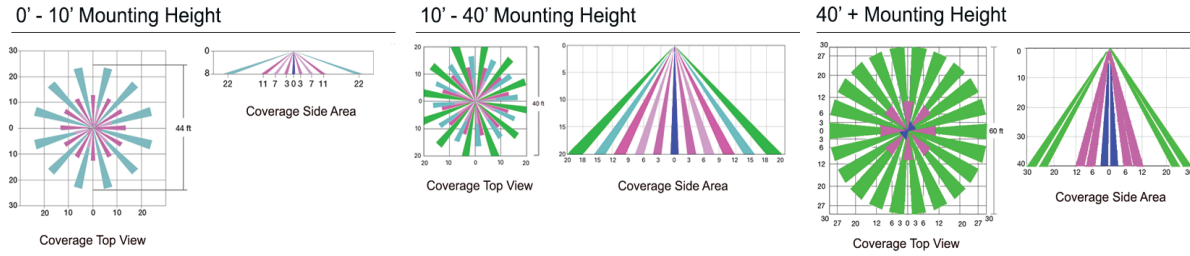

Occupancy Sensor Default Settings - Option OC2

Option	Dimmed State (Unoccupied)	High Level (When occupied)	Photocell Operation (OC4 Option Only*)	Dwell Time (Occupancy time delay)	Ramp-up Time (From unoccupied to occupied)	Ramp-up Time (From occupied to unoccupied)
OC2 and OC4	Approx. 20% Output	100% Output	Enabled @ 1.5 FC*	5 Minutes	Disabled	Disabled

*Note: OC2 and OC4 settings including photocell set point, high/low dim rates, and occupancy sensor time delay are all configurable by using the Wattstopper® App. If any other settings are desired to be set at the factory, please note these changes on Purchase Order.

Dimensions & Weights

Model	Width	Length	Height	Weight
LDS-SAL	13.25"	19.25"	4.35" 6.70" (MAS) 10.72" (SF)	15 lbs

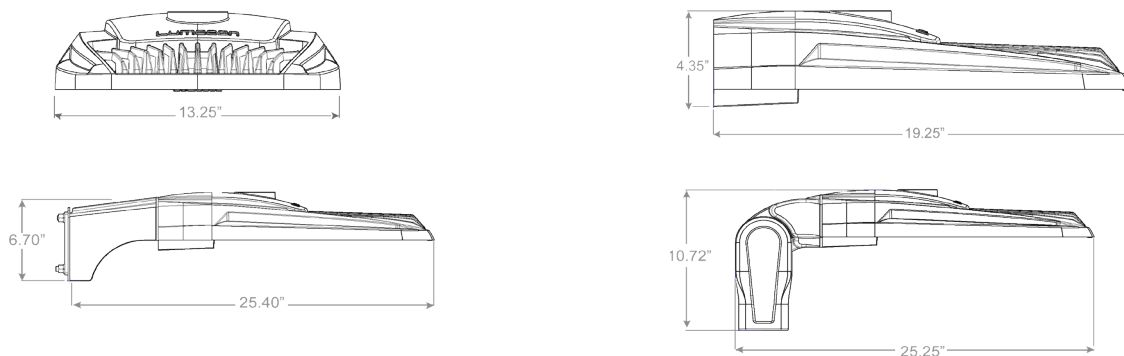

Color Option Samples

Due to variations in monitor settings and color printing settings, colors will not be exact.

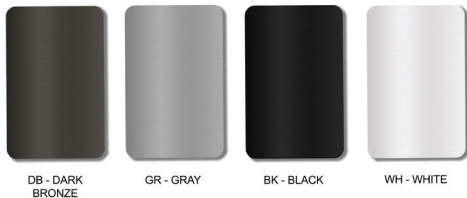

Mounting Method Dimensions

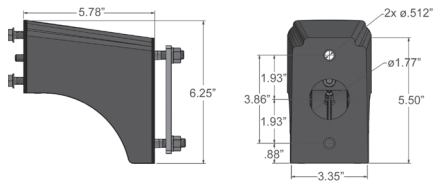

MAS - Square Pole Arm Dimensions

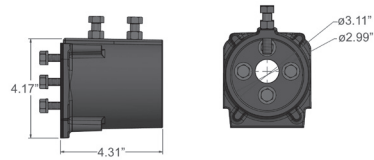

TM - Tenon Arm Dimensions

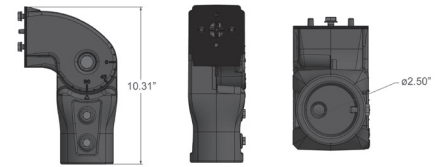

SF - Slip Fitter Arm Dimensions

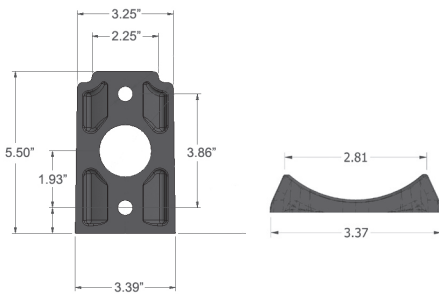

UARP - Universal Adaptor Round Pole

External Glare Shield and Full Glare Snoot Dimensions

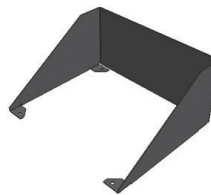
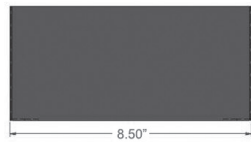
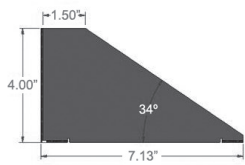

Field Installed for Forward Glare Reduction



Field Installed for Rear Glare Reduction

33-00112 – External Glare Shield

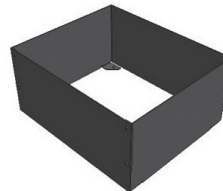
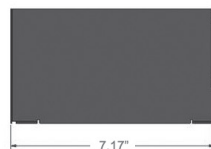

33-00120 – Full Glare Snoot

Backlight Louver(s)



BL - Backlight Louver(s) snap over LED Array(s) for Backlight Control at the source.
Works with Type 2, Type 3 and Type 4 arrays.

Performance Data

Model	Distribution Type	Watts	2200K					2700K					3000K					4000K					5000K				
			Lumens	B	U	G	Efficacy	Lumens	B	U	G	Efficacy	Lumens	B	U	G	Efficacy	Lumens	B	U	G	Efficacy	Lumens	B	U	G	Efficacy
LDS-SAL/LFC-30	Type 2	30	2,904	1	0	1	98	3,739	1	0	1	131	3791	1	0	1	132	4378	1	0	1	147	4393	1	0	1	148
	Type 3	30	2,927	1	0	1	99	3,769	1	0	1	132	3821	1	0	1	133	4412	1	0	1	149	4428	1	0	1	149
	Type 4	30	2,878	1	0	1	97	3,706	1	0	1	129	3757	1	0	1	131	4357	1	0	1	146	4352	1	0	1	147
	Type 5	30	2,975	2	0	2	100	3,749	2	0	2	131	3801	2	0	2	133	4474	2	0	2	151	4491	2	0	2	151
	Type 2	45	4899	1	0	1	103	6591	1	0	1	147	6683	1	0	1	149	6930	1	0	1	154	6975	1	0	1	155
LDS-SAL/LFC-45	Type 3	45	4635	1	0	1	97	6356	1	0	1	141	6445	1	0	1	143	6570	1	0	1	146	6570	1	0	1	146
	Type 4	45	4591	1	0	1	96	6172	1	0	1	137	6259	1	0	1	139	6525	1	0	1	145	6525	1	0	1	145
	Type 5	45	4738	3	0	2	99	6370	3	0	2	142	6459	3	0	2	144	6705	3	0	2	149	6750	3	0	2	150
	Type 2	60	5400	1	0	2	90	7620	1	0	2	127	7800	1	0	2	130	8100	1	0	2	135	8100	1	0	2	135
	Type 3	60	5400	2	0	2	90	7560	2	0	2	126	7680	2	0	2	128	8160	2	0	2	136	8220	2	0	2	137
LDS-SAL/LFC-60	Type 4	60	5340	2	0	2	89	7440	2	0	2	124	7560	2	0	2	126	8040	2	0	2	134	8040	2	0	2	134
	Type 5	60	5520	3	0	3	92	7680	3	0	3	128	7800	3	0	3	130	8280	3	0	3	138	8340	3	0	3	139
	Type 2	75	5700	2	0	2	76	8400	2	0	2	112	8550	2	0	2	114	8550	2	0	2	114	8775	2	0	2	117
	Type 3	75	5625	2	0	2	75	8325	2	0	2	111	8475	2	0	2	113	8475	2	0	2	113	8850	2	0	2	118
	Type 4	75	5925	2	0	2	79	8175	2	0	2	109	8325	2	0	2	111	8325	2	0	2	111	8700	2	0	2	116
LDS-SAL/LFC-75	Type 5	75	6450	3	0	3	86	8400	3	0	3	112	8550	3	0	3	114	8925	3	0	3	119	8775	3	0	3	117
	Type 2	80	7669	2	0	2	90	9128	2	0	2	111	9256	2	0	2	113	9293	2	0	2	114	9559	2	0	2	116
	Type 3	80	7575	3	0	3	89	9019	3	0	3	110	9146	3	0	3	112	9182	3	0	3	112	9630	3	0	3	117
	Type 4	80	7446	3	0	3	87	8865	3	0	3	108	8989	3	0	3	110	9024	3	0	3	111	9465	3	0	3	115
	Type 5	80	7685	4	0	2	90	9149	4	0	2	112	9277	4	0	2	114	10557	4	0	2	129	9550	4	0	2	116
LDS-SAL/LFC-85	Type 2	85	8949	2	0	2	105	10654	2	0	2	128	10796	2	0	2	129	11257	2	0	2	135	11719	2	0	2	141
	Type 3	85	9019	3	0	3	106	10737	3	0	3	129	10878	3	0	3	130	11344	3	0	3	136	11810	3	0	3	142
	Type 4	85	8696	3	0	3	102	10353	3	0	3	124	10495	3	0	3	126	10968	3	0	3	131	11440	3	0	3	138
	Type 5	85	9175	4	0	2	107	10923	4	0	2	131	11065	4	0	2	133	11540	4	0	2	138	12015	4	0	2	145
	Type 2	95	10644	2	0	2	125	12672	2	0	2	135	12813	2	0	2	137	13275	2	0	2	142	13737	2	0	2	147
LDS-SAL/LFC-95	Type 3	95	10713	3	0	3	126	12754	3	0	3	136	12896	3	0	3	138	13362	3	0	3	142	13828	3	0	3	148
	Type 4	95	10391	3	0	3	122	12371	3	0	3	132	12513	3	0	3	133	12986	3	0	3	138	13458	3	0	3	144
	Type 5	95	10870	4	0	2	127	12941	4	0	2	138	13083	4	0	2	140	13558	4	0	2	145	14033	4	0	2	150
	Type 2	110	12502	2	0	2	114	14955	2	0	2	135	14487	2	0	2	131	14520	2	0	2	132	14520	2	0	2	132
	Type 3	110	12599	3	0	3	115	15072	3	0	3	137	14599	3	0	3	132	14637	3	0	3	133	14637	3	0	3	133
LDS-SAL/LFC-110	Type 4	110	12146	3	0	3	111	14524	3	0	3	132	14350	3	0	3	130	14382	3	0	3	130	14382	3	0	3	130
	Type 5	110	12819	4	0	2	117	14698	4	0	2	133	14517	4	0	2	131	14549	4	0	2	132	14549	4	0	2	132
	Type 2	125	13970	2	0	2	111	16712	2	0	2	133	16463	2	0	2	131	16225	2	0	2	129	16225	2	0	2	129
	Type 3	125	14079	3	0	3	112	16841	3	0	3	134	16590	3	0	3	132	16353	3	0	3	130	16353	3	0	3	130
	Type 4	125	13572	3	0	3	108	16236	3	0	3	129	16307	3	0	3	130	16072	3	0	3	128	16072	3	0	3	128
LDS-SAL/LFC-125	Type 5	125	14000	4	0	2	112	16424	4	0	2	131	16496	4	0	2	131	16258	4	0	2	130	16258	4	0	2	130
	Type 2	160	16962	2	0	2	108	20290	2	0	2	129	20575	2	0	2	131	21395	2	0	2	137	21395	2	0	2	137
	Type 3	160	17095	3	0	3	109	20449	3	0	3	130	20735	3	0	3	132	21554	3	0	3	138	21554	3	0	3	138
	Type 4	160	16802	3	0	3	107	20100	3	0	3	128	20381	3	0	3	129	21183	3	0	3	136	21183	3	0	3	136
	Type 5	160	17136	5	0	3	109	20659	5	0	3	131	20659	5	0	3	131	21429	5	0	3	137	21429	5	0	3	137
LDS-SAL/LFC-160	Type 2	200	19200	2	0	2	96	24600	2	0	2	123	24800	2	0	2	124	24400	2	0	2	122	25000	2	0	2	125
	Type 3	200	19400	3	0	3	97	24800	3	0	3	124	25000	3	0	3	125	24600	3	0	3	123	25600	3	0	3	128
	Type 4	200	19000	3	0	3	95	23400	3	0	3	117	24600	3	0	3	123	24200	3	0	3	121	24800	3	0	3	124
	Type 5	200	19200	4	0	2	96	24200	4	0	2	121	25000	4	0	2	125	24600	4	0	2	123	25000	4	0	2	125
	Type 2	220	21120	2	0	2	96	27060	2	0	2	123	27280	2	0	2	124	27280	2	0	2	124	27280	2	0	2	124
LDS-SAL/LFC-220	Type 3	220	21340	3	0	3	97	27280	3	0	3	124	27500	3	0	3	125	27500	3	0	3	125	27500	3	0	3	125
	Type 4	220	20900	3	0	3	95	25740	3	0	3	117	27060	3	0	3	123	27060	3	0	3	123	27060	3	0	3	123
	Type 5	220	21120	4	0	2	96	26620	4	0	2	121	27500	4	0	2	125	27060	4	0	2	125	27500	4	0	2	125

Performance Data
Electrical Load Data

Fixture Model	Drive Current (mA)	System Watts (W)	AC Current Load (A)				
			120V	208V	240V	277V	480V
LDS-SAL-30	550	30	0.28	0.16	0.14	0.12	0.07
LDS-SAL-45	875	45	0.42	0.24	0.21	0.18	0.10
LDS-SAL-60	1100	60	0.56	0.32	0.28	0.24	0.14
LDS-SAL-75	1475	75	0.70	0.40	0.36	0.31	0.18
LDS-SAL-80	1480	80	0.74	0.43	0.37	0.32	0.19
LDS-SAL-85	695	85	0.79	0.45	0.40	0.35	0.20
LDS-SAL-95	840	95	0.89	0.51	0.44	0.39	0.23
LDS-SAL-110	975	110	1.02	0.59	0.51	0.44	0.25
LDS-SAL-125	1150	125	1.16	0.67	0.58	0.50	0.29
LDS-SAL-160	1450	160	1.48	0.85	0.74	0.64	0.37
LDS-SAL-200	1642	200	1.86	1.06	0.92	0.82	0.48
LDS-SAL-220	1925	220	2.05	1.17	1.00	0.90	0.53

Lumen Maintenance

Data in the table below references projected performance in a 25°C ambient and is based on 10,000 hours of LED testing. Performance data has been tested per IESNA LM-80-08 and projected per IESNA TM-21-11.

Use the lumen maintenance factor that corresponds to the desired number of operating hours below to calculate LLF.

Fixture Model	Lumen Maintenance Factors @ 25°C, by hours:				
	0	25,000	50,000	70,000	100,000
LDS-SAL-30	1.0	0.99	0.96	0.92	0.85
LDS-SAL-45	1.0	0.99	0.96	0.92	0.85
LDS-SAL-60	1.0	0.99	0.96	0.92	0.85
LDS-SAL-75	1.0	0.99	0.96	0.92	0.85
LDS-SAL-80	1.0	0.99	0.96	0.92	0.85
LDS-SAL-85	1.0	0.99	0.96	0.92	0.85
LDS-SAL-95	1.0	0.99	0.96	0.92	0.85
LDS-SAL-110	1.0	0.99	0.96	0.92	0.85
LDS-SAL-125	1.0	0.99	0.96	0.92	0.85
LDS-SAL-160	1.0	0.99	0.96	0.92	0.85
LDS-SAL-200	1.0	0.99	0.96	0.92	0.85
LDS-SAL-220	1.0	0.99	0.96	0.92	0.85