

CENOTE

USER MANUAL

AUXO



**READ THIS MANUAL BEFORE USING THE PRODUCT.
FAILURE TO FOLLOW INSTRUCTIONS AND SAFETY
PRECAUTIONS IN THIS MANUAL CAN RESULT IN
SERIOUS INJURY OR DEATH.**

**FOR EASY FUTURE REFERENCE, DOWNLOAD THIS
USER MANUAL AND WARRANTY CARD AT:
WWW.AUXO-OFFICIAL.COM/PAGES/DOWNLOAD**

CONTENTS

WHAT'S IN THE BOX	5
QUICK START	6
AUXO APPS AND PRO MODE	16
CLEANING AND MAINTENANCE	21
SAFETY	23
WARRANTY	25
RETURN & REFUND POLICY	27
WARRANTY CARD	28

WHAT'S IN THE BOX



Travel Case x1



Cenote Base x1

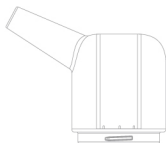

Glass Recycler* x1



Disposable Ceramic Nail** x5



Tweezers x1

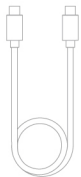

USB-C to USB-C Charging Cable x1



20W Charging Adapter x1



Nozzle x1

x 5



Cotton Swab x5



Carb Cap x1



Silicone Rod Seal x2



Loading Tool x1



Quick Start & User Manual x1

*Each glass piece is handblown and may vary slightly in shape and size.

**Visit the AUXO official website to purchase additional ceramic nails.

QUICK START

1. Set Up

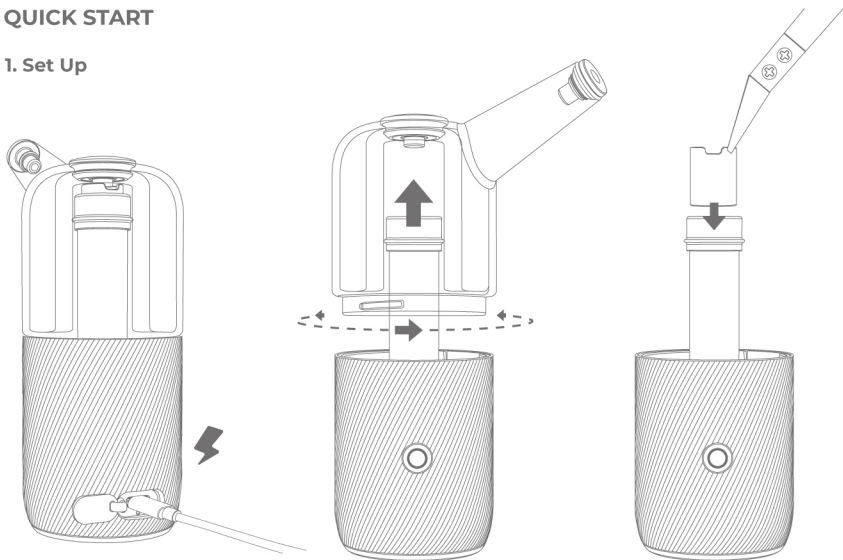

Fully charge before use.

Press ceramic nail firmly into the heating rod.

2. Fill

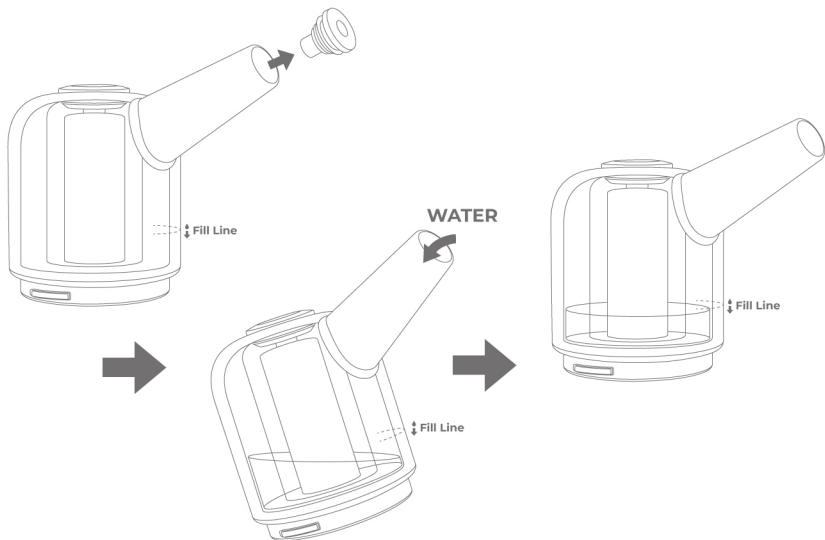

Remove nozzle, fill water via the mouthpiece.

3. Install

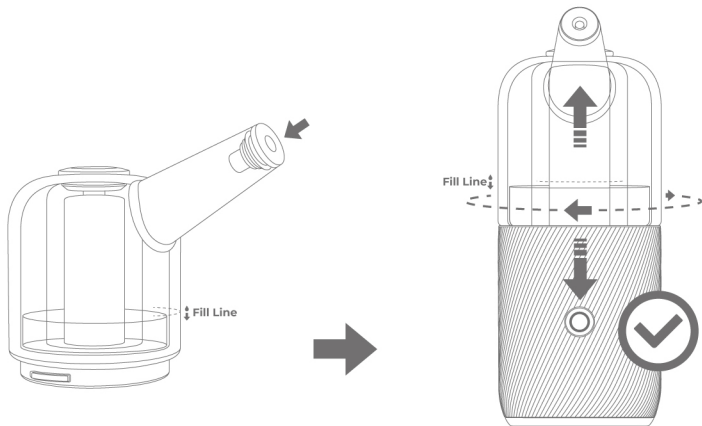

Place nozzle back and secure glass recycler on device.
Mouthpiece should align with power button.

4. Load

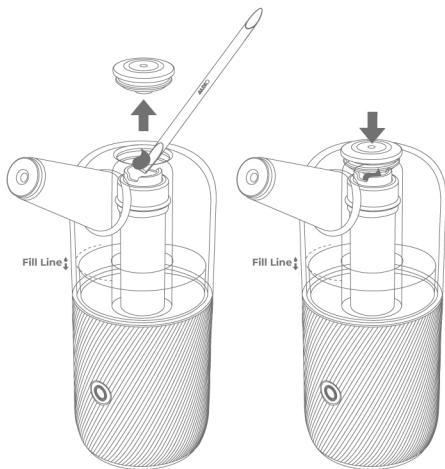

Remove carb cap and place material in nail.

*The recommended dab size is about half that of a Tic-Tac.

Secure carb cap back in place.

5. Turn On

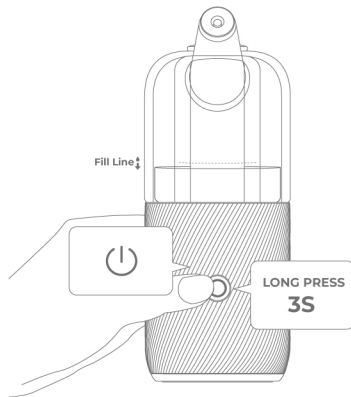

Tip: If no activity is detected for 10 minutes or longer, Cenote will turn off automatically.

6. Select

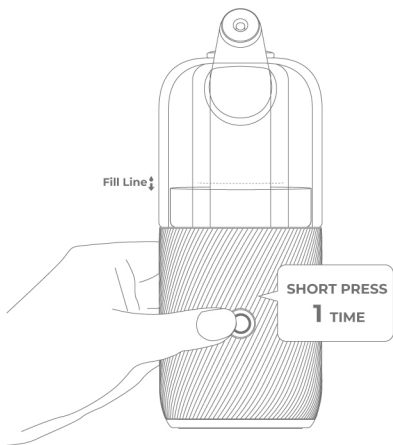

Select the temperature setting.
(see next page for setting indications)



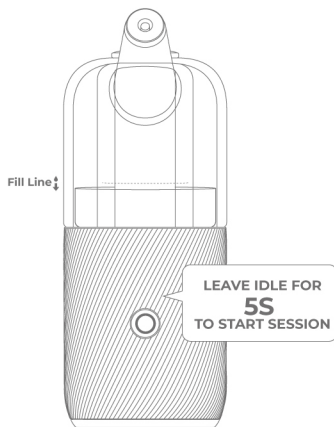

7. Start



Tip: The device will start preheating for about 28 seconds before the session begins. The session start will be indicated by a vibration and lighting change.

Heat Settings

Settings 1-3 can be controlled on the device itself whereas Pro Mode is controlled via the AUXO Apps*.

Heat Setting	1	2	3	PRO MODE
Lighting				
Temperature	518°F (270°C)	572°F (300°C)	626°F (330°C)	392 - 644°F (200-340°C)
Session Duration	40s	40s	80s	20s-90s

*Default temperature and duration of Pro Mode are identical to setting 3 until adjustments are made on the app.

8. Enjoy

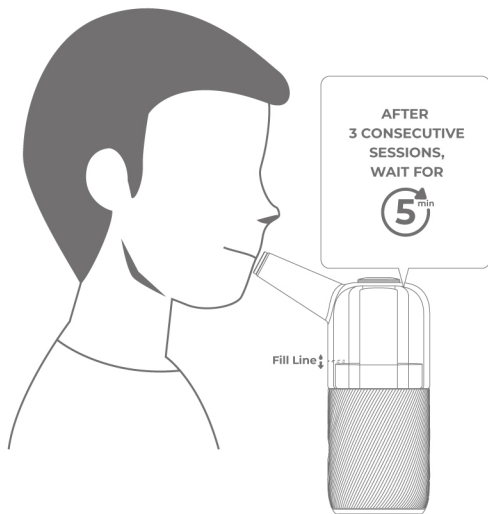

Tip: To terminate mid-session, short-press the power button to end. The device will go into standby mode.

9. Extend

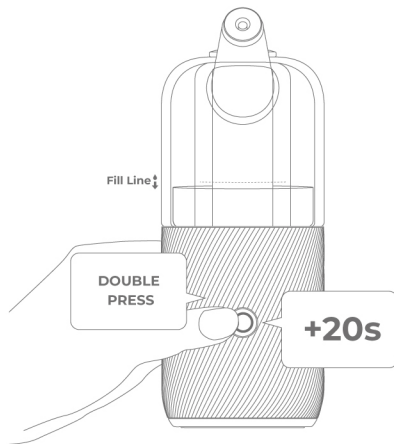

Double press power button (20s before session ends) to extend session.

LED Indications



Preheating
(Deck light)



Standby
(Base light)



Connecting to Bluetooth



Cool down
Steady red, gradual dim out



Short circuit protection



Nail error



Low battery



Overheat protection

Charging & Battery Level

- Due to safety precautions, the product cannot be used while charging.
- To charge the device, plug in the USB-C cable directly into the device's charging port. Cenote also supports wireless charging; any Qi-certified wireless chargers are compatible.
- Charging via the 20W power adapter takes approx. 1.5 hours for a full charge. Every full charge generates approx. 12-session usage (calculation based on 100s per session).

Battery Level Indication

To check the battery level, press the power button 3 times consecutively*; the base light will indicate the battery level. Alternatively, you can find the precise battery level in the AUXO Apps.



10% and below: power button blinks in red 6 times before powering off.



10-30%



30-60%



60-80%



80-100%

*Caution: Should there be water in the glass recycler, avoid tilting the device when checking the battery level.

AUXO APPS AND PRO MODE

Download the AUXO Apps to explore Pro Mode, lighting effects, and more.

For iOS

1. Search for "All-On Browser" in the App Store.
2. Download and install the app onto your phone.
3. Enter www.auxo-app.com into the address bar.
4. Allow the app to access the phone's Bluetooth and wireless data.
5. Connect your device to the app (see next page).



For Android

1. Search for "AUXO Connect" on the Google Play Store.
2. Download and install the app onto your phone.
3. Connect your device to the app (see next page).



Pairing

1. Turn on Bluetooth on your phone and place the device near your phone.
2. When the device is found, select accordingly. The LED light will blink in blue when paired successfully.
3. If the connection is unsuccessful, restart the app and try connecting again.



If the connection is unsuccessful, restart the app and try connecting again.
If you're having trouble pairing Cenote with your phone, ensure the following:

1. Your connecting app is up to date.
2. Your device is turned on (restart if necessary).
3. The Bluetooth on your phone is turned on.
4. The device is near your phone (as close as possible).
5. If on Android, your location services are enabled (mandated by Android).

Control Panel

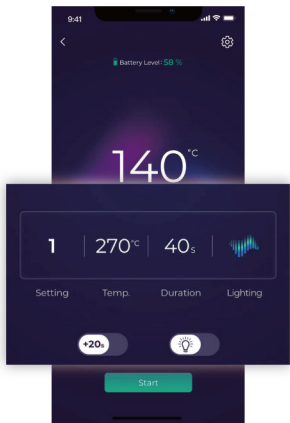

(Left to right)

Row 1 – heat setting, temperature adjustment, session duration, lighting effect.

Row 2 – Session extension, lighting effect extension.

Heat Settings

Scroll the settings bar to select your preferred option between settings 1-3 or Pro Mode.

Temperature Adjustment

Only available via Pro Mode. For settings 1-3, the setting's temperature will be displayed.

Session Duration

Only available via Pro Mode, between 20s and 90s. For settings 1-3, the setting's duration will be displayed; session extendable by pressing the extension switch beneath.

Lighting Effect

Effects controlled in the control panel will reflect directly on your device as you start your session.

Session Extension

Assess the flavor of your material after every session. Extend session for another 20 seconds by pressing the session extension switch  to activate. Not applicable to Pro Mode.

Lighting Extension

To keep the lighting effect on after the session, press the switch  to activate.

Device Settings

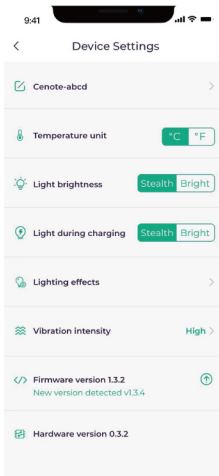

Unit of Temperature

Select your preferred temperature scale, Fahrenheit (°F) or Celsius (°C).

Light Brightness

Dim out or maximize the brightness of the lighting effect for sessions.

Light During Charging

Dim out or maximize the brightness of the lighting effect during charging.

Lighting Effects

Add up to 8 lighting effects to your selection. New lighting effects will be available upon notification.

Vibration Intensity

Adjust the vibration intensity to your preference, low or high.

In-Session Lighting Effects



Lumino (Default)



Aurora



Purple Haze



Pink Flamingo



UFO



Lava



Lighthouse



Zen

*More options available upon in-app notification.

CLEANING AND MAINTENANCE

Disposable Ceramic Nail:

1. Let the heating rod and ceramic nail cool down to room temperature.
2. Lift the carb cap to expose the heating nail.
3. Dip cotton swab in 90% isopropyl alcohol and clean nail thoroughly.

Tip: For best performance and flavors, replace the nail based on its condition.

Glass Recycler:

1. Carefully remove the glass recycler from Cenote base before cleaning.



Don't handle if hot.

2. Separate the nozzle from the mouthpiece and the silicone and glass components from the carb cap.
3. Once removed, soak all glass components in 90% isopropyl alcohol.
4. Remove from isopropyl alcohol and rinse clean with water.
5. Allow glass components to dry thoroughly before reattaching to Cenote base.

Caution: Cleaning and maintenance must NOT be performed before the device is turned off and cools down to room temperature. Do not submerge the battery/device base in any form of liquid.

Warning:

 **Isopropyl alcohol is highly flammable. Let the attachments dry completely before heating.**

Choking Hazard – Disassembled glass recycler contains small parts. Keep away from children and pets.

Storage

- Do not expose the device to direct sunlight, dust, moisture or mechanical shock.
- Do not place heavy loads on the device or drop it, the device may no longer work properly if such occurs.

Temperature and Humidity

- If the battery temperature is over $149\pm 1.8^{\circ}\text{F}$ ($65\pm 1^{\circ}\text{C}$), overheat protection will be implemented and usage will be suspended temporarily.
- It is recommended to store and operate the device under the following environments:



Charging temperature: $50\text{-}113^{\circ}\text{F}$ ($10\text{ to }45^{\circ}\text{C}$)
Working temperature: $14\text{-}140^{\circ}\text{F}$ ($-10\text{ to }60^{\circ}\text{C}$)
Storage temperature: $73.4\pm 9^{\circ}\text{F}$ ($23\pm 5^{\circ}\text{C}$)



Operating humidity: $35\%\text{-}75\%\text{RH}$
Storage humidity: $35\%\text{-}70\%\text{RH}$

SAFETY

- Do not attempt to disassemble or repair the device as damage or personal injury may occur.
- Keep body parts, clothing, etc. away from the heat source to prevent scalding or damage to personal property.
- To prevent scalding, do not touch the heating rod or ceramic nail before it's completely cooled down.
- Refrain from using other power adapters not provided with the device when charging Cenote.
- Keep hands dry when touching the charging device to prevent electric shock.
- The device is not water-resistant and not recommended for outdoor use while it is raining, or in other circumstances where it may be exposed to water.
- Do not use while pregnant or breastfeeding.
- If any abnormality is observed, stop using immediately and contact a professional after-sales service technician.
- Keep the device out of reach of children.

FCC Compliance Statement

FCC Warning:

The user is cautioned that changes or modifications not expressly approved by the party responsible for compliance could void the user's authority to operate the equipment.

This device complies with Part 15 of the FCC Rules. Operation is subject to the following two conditions: (1) this device may not cause harmful interference, and (2) this device must accept any interference received, including interference that may cause undesired operation.

NOTE: This equipment has been tested and found to comply with the limits for a Class B digital device, pursuant to Part 15 of the FCC Rules. These limits are designed to provide reasonable protection against harmful interference in a residential installation. This equipment generates, uses and can radiate radio frequency energy and, if not installed and used in accordance with the instructions, may cause harmful interference to radio communications. However, there is no guarantee that interference will not occur in a particular installation.

If this equipment does cause harmful interference to radio or television reception, which can be determined by turning the equipment off and on, the user is encouraged to try to correct the interference by one or more of the following measures:

- Reorient or relocate the receiving antenna.
- Increase the separation between the equipment and receiver.
- Connect the equipment into an outlet on a circuit different from that to which the receiver is connected.
- Consult the dealer or an experienced radio/TV technician for help.

FCC Radiation Exposure Statement

This equipment complies with FCC radiation exposure limits set forth for an uncontrolled environment. This transmitter must not be co-located or operating in conjunction with any other antenna or transmitter.

Environmentally Friendly Disposal

You can help protect the environment! Please remember to respect local regulations, and hand in any electrical equipment you wish to dispose of at an appropriate waste disposal center.

WARRANTY

Limited Warranty Coverage

AUXO provides a limited warranty on authentic products purchased from the official website and authorized offline stores against defects in materials and/or workmanship under normal use. In order to keep this limited warranty in effect, the product must have been handled and used as prescribed in the instructions accompanying this warranty. AUXO warrants only to the original purchaser of the product and the limited warranty is nontransferable. The limited warranty does not apply to products that were sold by any third-party resellers.

AUXO offers a 10-year limited warranty on the device (glass recycler not included). Other attachments and accessories not aforementioned are not covered under the limited warranty.

In no event shall any recovery against our brand exceed the actual price paid for the purchase of the product.

Not Covered Under Warranty

This warranty does not apply to certain situations and conditions, including but not limited to:

1. Any product sold by unofficial website or unauthorized offline store(s).
2. Damage(s) caused by accident, abuse, misuse, negligence, flood, fire, earthquake or other external causes.
3. Damage(s) caused by the device being exposed to or coming in contact with moisture (e.g. liquids, water, rain, extreme humidity, unusually heavy perspiration or other moisture), or extreme thermal or environmental conditions (e.g., sand, food, dirt or similar substances).
4. Damage(s) caused by operating the device or charging adapter outside the permitted or intended use as prescribed in the user manual.
5. Damage(s) of the heating rod due to tampering, counterfeit or by filling the ceramic nail with unrecognized or unintended materials.
6. Damage(s) caused by modifications to alter functionality or capability.
7. Cosmetic damage occurring through wear and tear, including but not limited to scratches, dents and broken plastic on ports.

8. Any device or charging adapter where the serial number has been tampered with, erased or obscured, or is not genuine.
9. Normal performance degradation of batteries. Please contact AUXO Customer Support for more information on battery degradation.
10. Any other attachments and accessories which can be purchased separately.

Obtaining Warranty Service

Please retain your purchase receipt or other acceptable proof of purchase for your records. Contact the AUXO Customer Support Team. We encourage you to include as many details as you can in the request, such as pictures and videos to help the team diagnose the issue.

An RMA (Returned Material Authorization) number and shipping instructions will be sent to you if the issue cannot be resolved. Following the shipping instructions, you will need to send the product along with the RMA number.

Note:

1. You must return your approved-for-warranty device or accessory before AUXO sends you a replacement on your warranty claim.
2. Customers are responsible for all shipping costs associated with the warranty process.
3. AUXO is not responsible for lost or damaged returns sent by the customer.

RETURN & REFUND POLICY

Please carefully research the product you are interested in before purchasing.

Refunds are only available for new and unused devices purchased on AUXO official website and must be returned to AUXO within fourteen (14) days of receipt. If the tamper-proof seal is broken, a refund cannot be honored. AUXO will not refund devices purchased through other authorized retailers; in such case, any refunds must be obtained from the authorized retailer whom you purchased the device from and will be subject to the retailer's policy on refunds.

Note: The customer is responsible for the return shipping fee.

Additional Warranty Terms and Conditions

THERE ARE NO WARRANTIES WHICH EXTEND BEYOND THE DESCRIPTION ON THIS CARD. AUXO DISCLAIMS AND EXCLUDES ANY IMPLIED WARRANTIES, INCLUDING BUT NOT LIMITED TO MERCHANTABILITY, AFTER THE EXPIRATION OF 10 YEARS AFTER PURCHASE BY THE END USER. Some states do not allow limitations on how long an implied warranty lasts, so the above limitation may not apply to you.

In no event will AUXO be liable for any special or consequential damages arising from the use of this product, nor for injury to any person, or any claim for damages arising from the use of this product. Some states do not allow the exclusion or limitation of incidental or consequential damages, so the above limitation may not apply to you.

WARRANTY CARD

Product: _____

Serial Number: _____

Date of Purchase (Per purchase receipt):

Date (YYYY/MM/DD): _____

Store Information:

Store Name: _____

Store Address: _____

City: _____ State: _____ ZIP Code: _____

Customer Information:

Name: _____

Phone # or email: _____

Address: _____

City: _____ State: _____ ZIP Code: _____

**AUXO reserves the right to the final decision in all warranty cases.
AUXO may interpret and revise the content of this warranty card.**

**Please present your warranty card together with your proof of purchase in order
to obtain your warranty service.**

Not for sale to minors.

This vaporizer is only intended for use with products made from federally legal hemp as defined in relevant provisions of the 2018 Farm Bill and codified at 7 U.S.C. § 1639o(1) and 21 U.S.C. § 802(16)(B)(i) and is not intended for use with any illegal controlled substance.

This product is not designed or intended to vaporize any nicotine or liquid product.

WARNING: Reproductive Harm - www.P65warnings.ca.gov

Visit us at WWW.AUXO-OFFICIAL.COM

FOLLOW US @AUXOVAPOR



© AUXO All rights reserved. Subject to alteration.