

COMFORT SLEEPER® BY AMERICAN LEATHER®

KLEIN

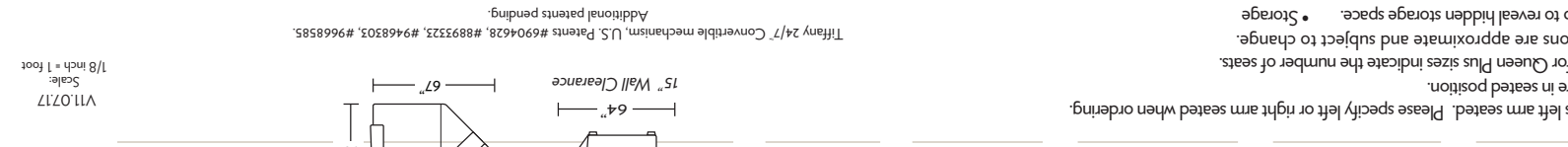

**AMERICAN
LEATHER®**

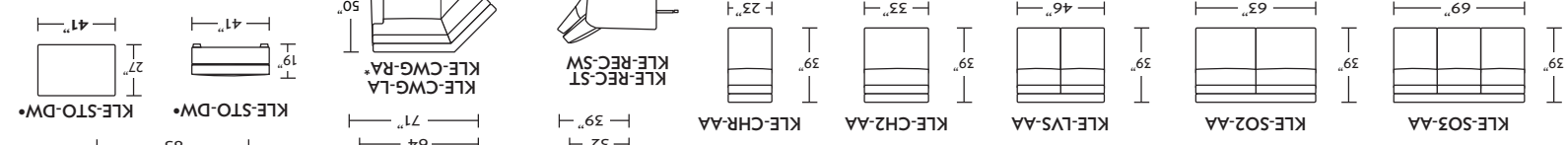
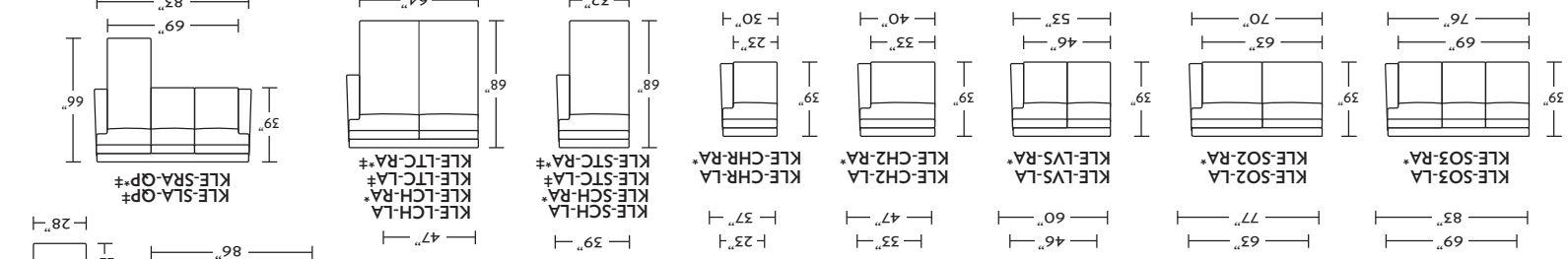
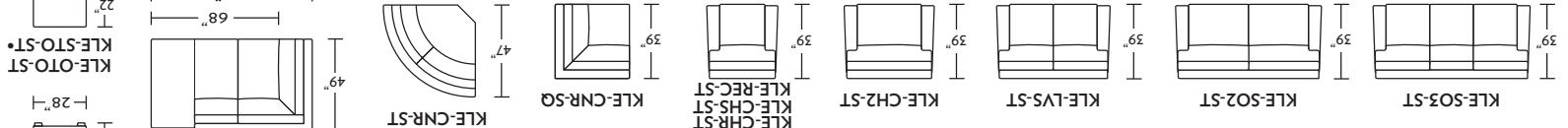
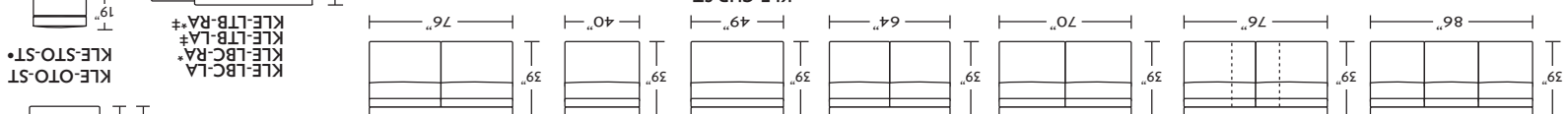
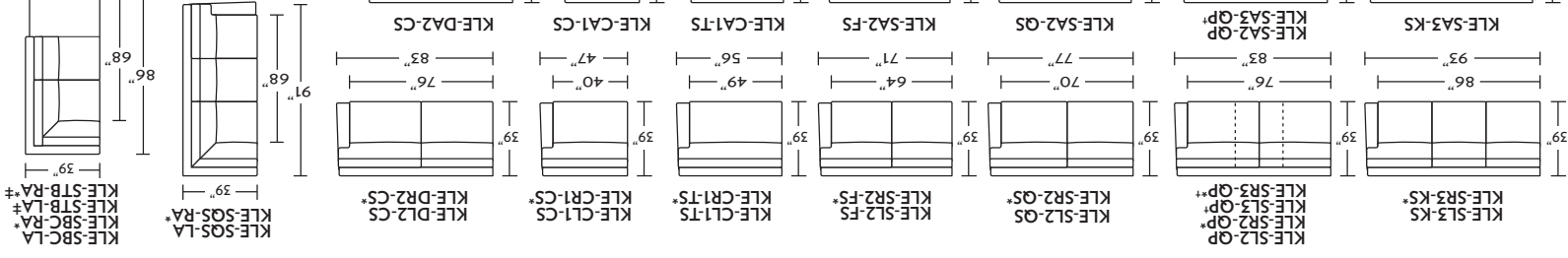
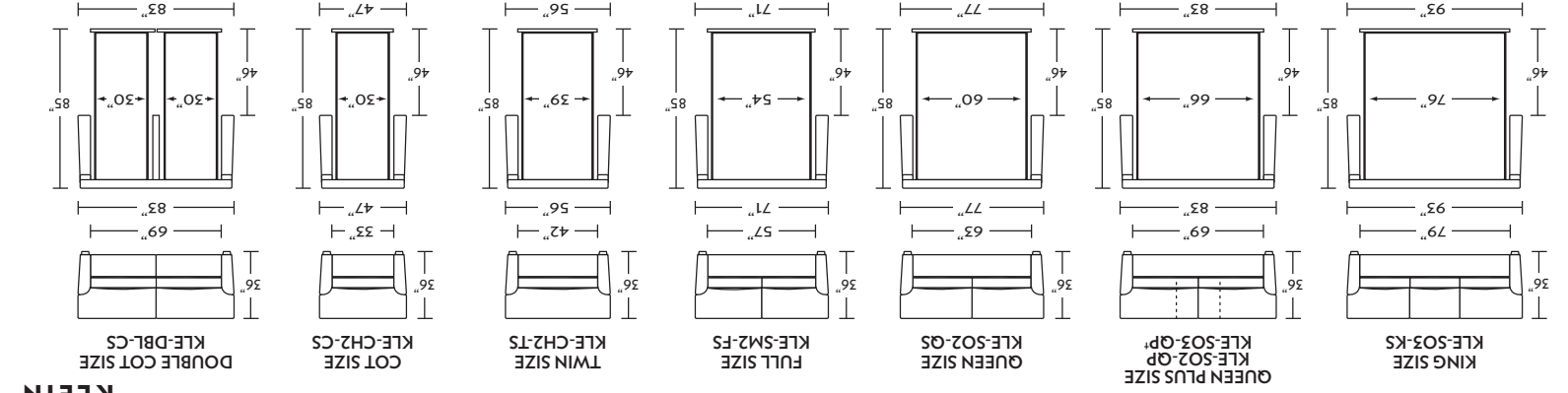

- Features:**
- Featuring the patented Tiffany 24/7™ platform sleep system
 - Room to stretch out with true 80 inches of bedroom-length sleeping surface
 - Ultimate comfort on five inches of plush, high-density foam mattress
 - Under-sofa dust cover keeps dust and dirt from ever touching the mattress
 - Zero wall clearance
 - Quick-ship delivery
 - Double-needle top-stitch
 - High-density, high-resiliency foam seat cushions
 - Loose back and seat cushions
 - Lifetime warranty on frame
 - 10-year mechanism warranty

- Mattress Options:**
- Premier with Crypton® ticking
 - Gel
 - Tempur-Pedic®

- Options:**
- High-density, high-resiliency foam seat cushions encased in down and down back cushions available
 - Wood legs available in Acorn, Espresso or Walnut finish
 - Nailhead trim available in Antique Brass, Chrome or Pewter finish (arms and deck)

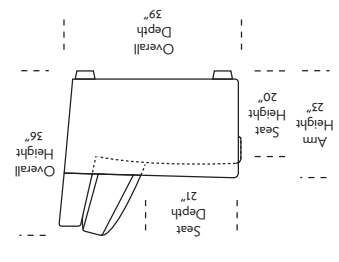

Please use actual leather, fabric, Crypton®, Sunbrella and Ultrastuede swatches when specifying furniture as the colors shown may vary due to the printing process.

*Picture shows left arm seated. Please specify left or right arm seated when ordering.

† All orders are in seated position.
‡ Dotted lines for Queen Plus sizes indicate the number of seats.
§ All dimensions are approximate and subject to change.
¶ Chase lifts up to reveal hidden storage space. • Storage.

Tiffany 24/7 Convertible mechanism, U.S. Patents #6904628, #8893323, #9468303, #9668585.
Additional patents pending.

V11.0717
Scale: 1/8 inch = 1 foot