

**Biological Safety Cabinet**  
**11231 BBC 86-Pro**  
**Maintenance Manual**

**Version 2023.8.11**

# Catalogue

---

|   |        |
|---|--------|
| 1 Product Structure.....  | - 1 -  |
| 2 Common parts Replacement and Operation .....  | - 9 -  |
| 2.1 Fuse replacement.....   | - 9 -  |
| 2.2 Open the front operation panel.....   | - 9 -  |
| 2.3 Power key replacement .....   | - 10 - |
| 2.4 Splash-proof sockets replacement.....   | - 10 - |
| 2.5 Replacement of UV lamp and UV lamp ballasts .....                                 | - 11 - |
| 2.6 LED Lighting tubes replacement .....  | - 12 - |
| 2.7 Front window glass Replacement .....  | - 12 - |
| 2.8 Glass door motor replacement .....  | - 13 - |
| 2.9 Hygrothermograph replacement.....   | - 14 - |
| 2.10 Air tubes replacement.....   | - 15 - |
| 2.11 Filter and fan replacement.....  | - 16 - |
| 3 Equipment Faults and Repairing.....   | - 23 - |
| Fault 1 The device is not energized.....  | - 23 - |
| Fault 2 The screen does not light up (normal alarm on) .....                          | - 23 - |
| Fault 3 Power lock does not respond and the screen does not light up (power-on alarm) | - 24 - |
| .....   | - 24 - |
| Fault 4: The machine is not energized .....   | - 24 - |
| Fault 5: The front window is not at a safe height without alarming .....              | - 24 - |
| Fault 6 Front window lift failure .....   | - 26 - |
| Fault 7 Remote control failure .....  | - 27 - |
| Fault 8 No power in the operating area socket.....                                    | - 28 - |
| Fault 9 Lighting does not light up .....  | - 29 - |
| Fault 10 UV lamp does not light .....   | - 29 - |
| Fault 11 Fan does not work .....  | - 30 - |
| Fault 12 Differential pressure and wind speed showing not in rated range .....        | - 31 - |
| Fault 13 Warning Filter differential pressure is super high.....                      | - 32 - |
| Fault 14 Front window glass broken.....   | - 32 - |
| Fault 15: Clock display adjustment.....   | - 33 - |
| Fault 16: Glass door rise fault .....   | - 33 - |
| Fault 17: Temperature and humidity display is incorrect.....                          | - 33 - |
| Fault 18: Abnormal air pressure display .....   | - 34 - |
| Fault 19: Inflow wind speed is zero, declining wind speed is zero.....                | - 35 - |
| Appendix: Wiring Schematic Diagram .....  | - 36 - |

## Preface

---

---

This service manual provides instructions on the construction and maintenance of the safety cabinets from us. If you attempt to repair or maintain the cabinet without proper training and proper tools and equipment, you may injure yourself or others, and may damage the equipment or cause it to fail to operate properly. We are not responsible for product failure or other personal or property injury caused by unauthorized disassembly.

This manual contains various "warnings" and "cautions" that must be followed carefully to reduce the risk of injury during repair or maintenance. Improper repair or maintenance can damage the equipment and pose a safety hazard. These "warnings" and "cautions" are not exhaustive, and this manual cannot warn and compensate for all potentially dangerous consequences of violating these instructions.

We recommend that you contact our after-sales technicians in a timely manner to obtain the latest information on the products and parts related to this manual involved in the repair process. All information, illustrations and product descriptions included in this manual are in accordance with the situation at the time of publication of this manual. However, the Company reserves the right to make changes to this manual at any time without prior notice and under unrestricted conditions.

No part of this guide can be reproduced, uploaded in a retrieval system or transmitted in any form without our permission, and the above statement applies to text, illustrations and tables.

# 1 Product Structure

## 1.1 Mechanical structure

The structure of 11231 BBC 86-Pro Biological Safety Cabinet is as follows.

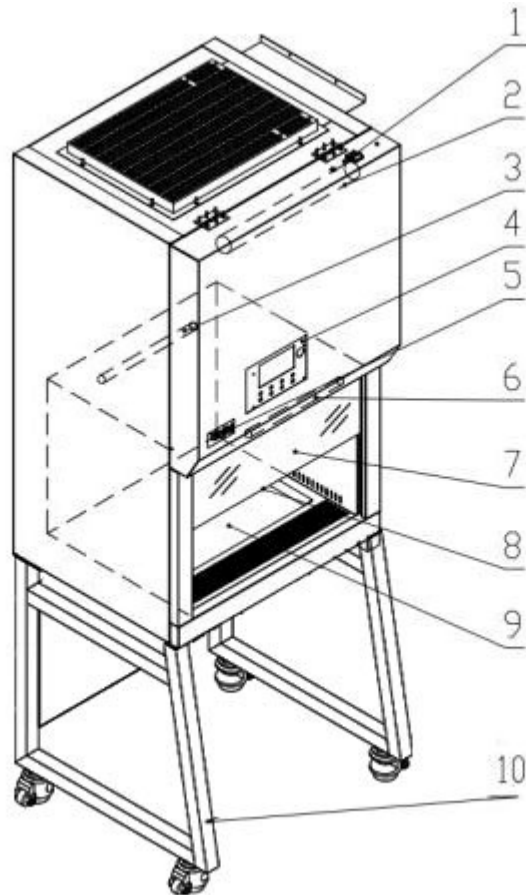

Figure 1

|   |                           |    |               |
|---|---------------------------|----|---------------|
| 1 | Power socket, fuse holder | 2  | Motor         |
| 3 | UV lamp                   | 4  | Control panel |
| 5 | Nameplate                 | 6  | LED light     |
| 7 | Waterproof socket         | 8  | Front window  |
| 9 | Work surface              | 10 | Base stand    |

## 1.2 Electrical structure

### 1.2.1 Front panel electrical structure





Figure 2

### 1.2.2 Control board structure

Control board is the pivot of overall control, screen board and strong electrical board control are sent by the control board and processing orders. Due to different versions or batches, if there is "main control board", "weak board" and other names appeared in the actual maintenance, it is the same role of the electrical components as the control board in this manual, specific photos can be taken to contact the manufacturer to confirm the details.

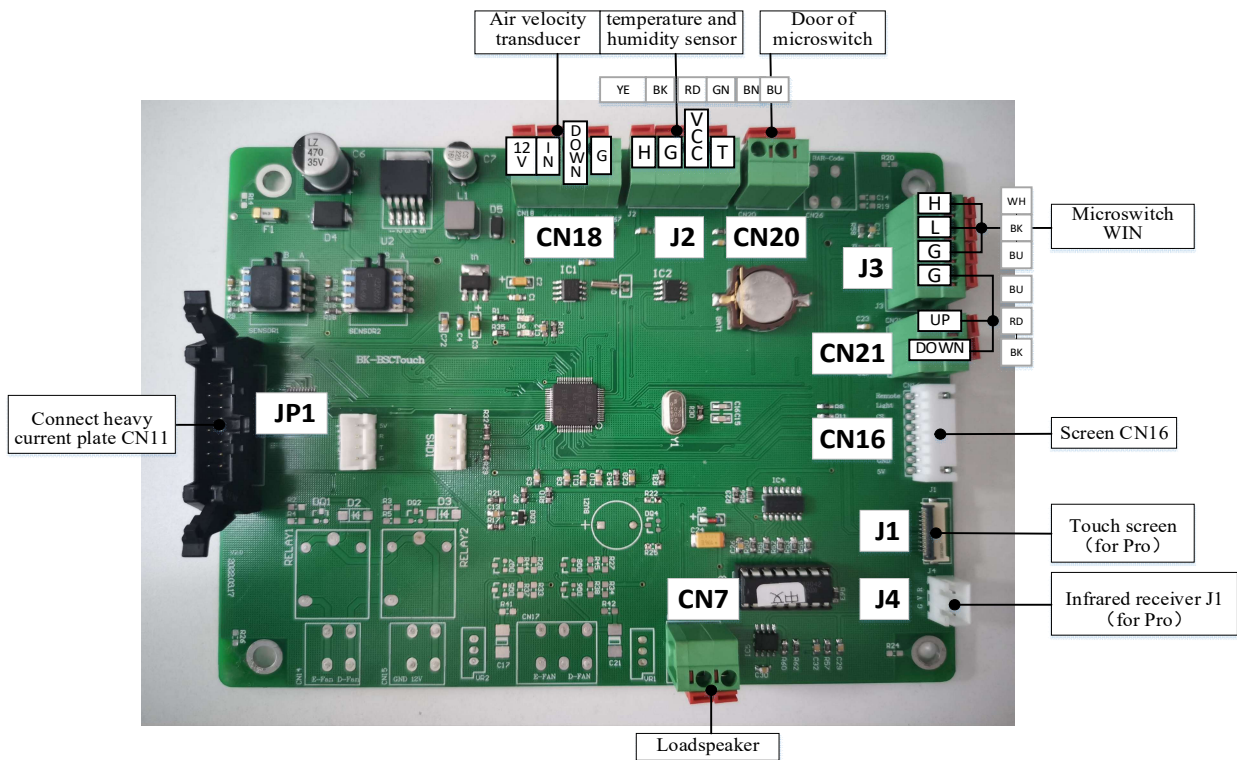

Figure 3

### 1.2.3 Heavy current panel structure

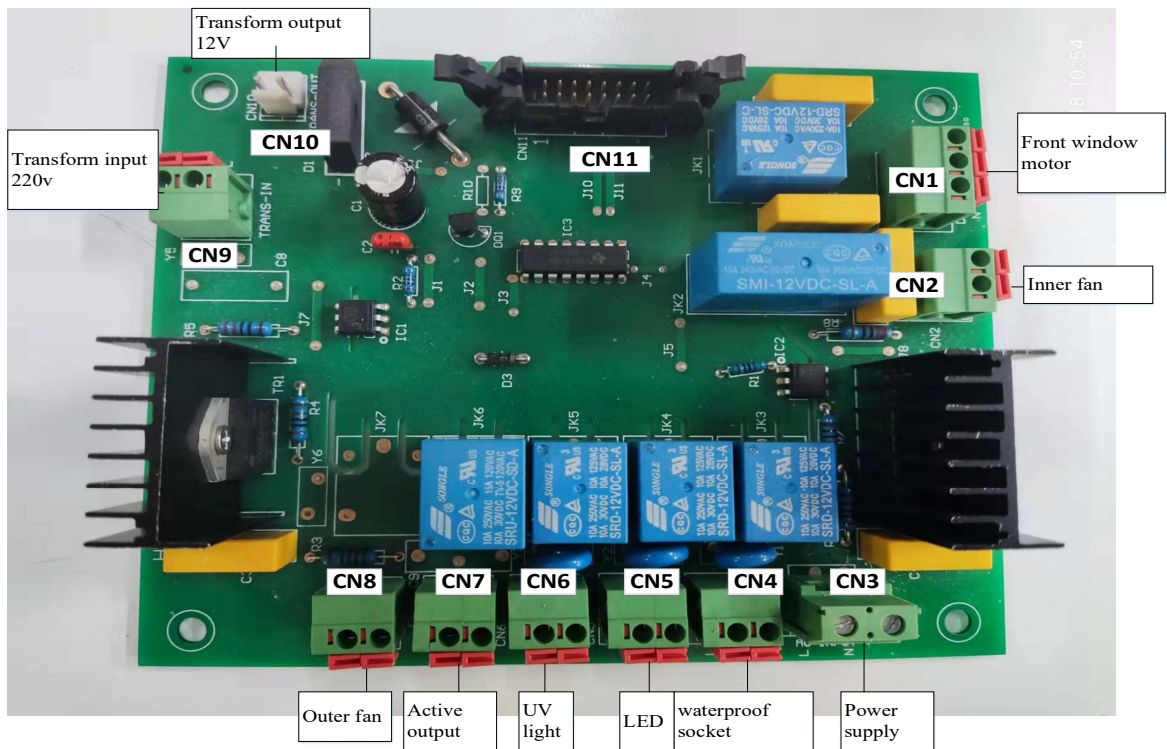

Figure 4

### 1.2.4 Touch Screen

Touch screen back picture is as follow.



Figure 5

### 1.3 Control screen and functions

After the machine is powered on, the screen open, click the standby interface, and then enter the main screen, as shown in the following picture.

#### 1.3.1 Touch screen (LCD)

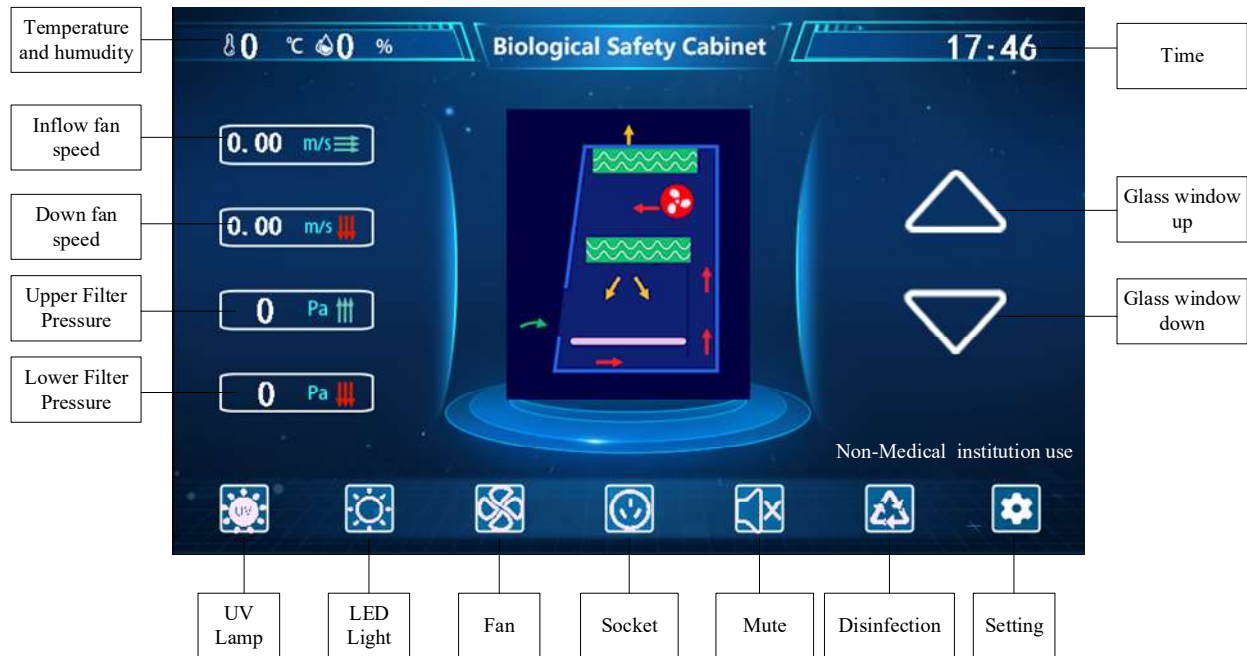

Figure 6

#### 1.3.2 Key Function Introduction

The main operations of the equipment can all be carried out by the operation of the light touch keys.

**UV key:** the control key of the UV lamp. Each time you press it, the state of the UV lamp and the corresponding indication state on the LCD will change once, i.e. from bright to off, or from off to bright. (This key is valid only when the glass door is completely closed).

**LED Light key:** the control key of the LED light. Each time you press it, the state of the LED lighting tube and the corresponding indication state on the LCD will change once, that is, from bright to off, or from off to bright.

**Fan key:** the control key of the fan working status. Each time you press it, the working state and the corresponding indication state on the LCD will change once. (When the glass door is closed, this key is in non-working state).

**Socket key:** It is the control key for the working status of the socket power on and off. Each time you press it, the on/off status and the corresponding indication status on the LCD will change once.

**Mute key:** switch the sound on and off key, if this key is pressed when the sound is on, the sound will be muted; on the contrary, the sound will be turned on.

**Disinfection key:** In the case of glass door closing, click one key disinfection key, UV lamp will be turned on after 1 minute, and UV lamp will be turned off automatically after 30 minutes.

**Setting key:** enter the instrument debugging interface, you can adjust the timing switch, fan and standby, check the life of the equipment.

**Front window glass up key:** If the front window glass is closed, click the front window glass rising key, the door will keep rising and stop when 200mm from the table panel; click the key again, then the front window glass rises to the highest point of the trip; in the glass running process, click the key, then immediately suspend the glass running.

**Front window glass down key:** If the front window glass is above 200mm from the sill plate, click the front window glass down key, the glass door will continue to fall and stop when it is 200mm from the sill plate; click the key again, the front window glass will stop after falling to the lowest point; during the operation of the front window glass, the motor key, the glass immediately stops moving.

**Clock:** the current time. If you need to set or change the time, click this position and enter in order: year-month-day-hours-minutes-seconds, if you do not need to change the time, please do not click this place.

### 1.3.3 Time Setting

After entering the screen for the first time, you need to set the time first

The time setting order is: year → month → day → hour → minute → second

In order to follow the order, enter the year, month, day, hour, minute and second respectively, and automatically save it after the input is finished, and the current moment is shown in the

Figure .

### 1.3.4 Timing switch

Click the screen setting key  to enter the setting interface.



Figure 7

Select "Time switch"  to enter the time switch interface.



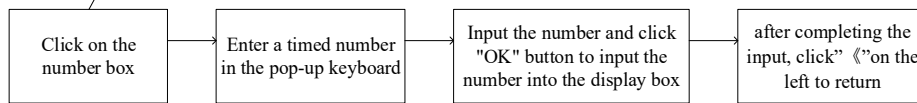

Figure 8

According to the above operation method, you can operate the time off and other time functions.

### 1.3.5 Fan setting



Click the screen setting key to enter the setting interface.

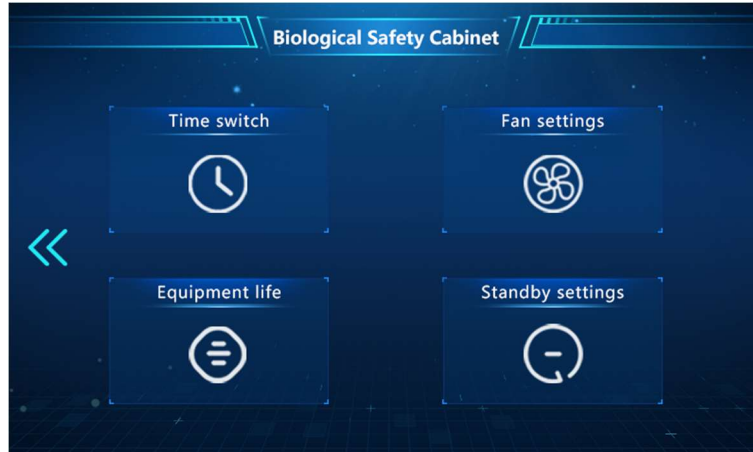

Figure. 9

Select "Fan settings" 



Figure 10

Enter the password: 1234(or 1111) in this interface to enter the fan commissioning interface.

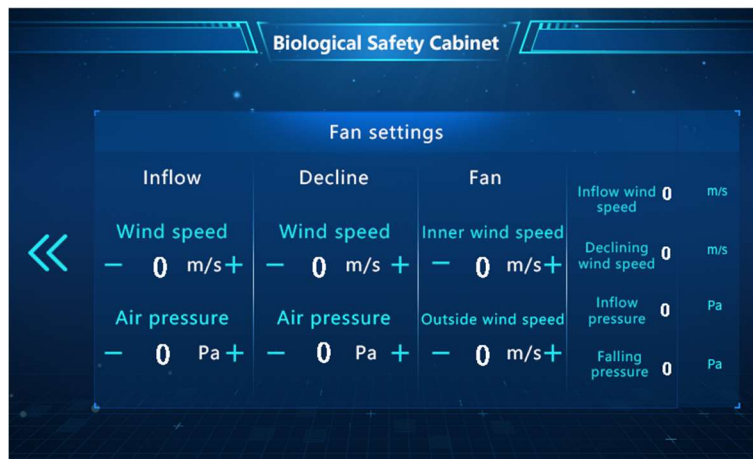



Figure. 11

According to the wind speed requirements, adjust the fan speed respectively (A2 type only need to adjust the inner fan, B2 type need to adjust the inner and outer fan), press  to decrease speed, press  to increase.

After adjusting the wind speed, adjust the wind speed and pressure of "Inflow" and "Decline" respectively, and increase and decrease the corresponding numbers by +/- . The rightmost area is the final scree data, the data will be adjusted to the inspection requirements.

Note: Safety cabinet in the process of use (standard, inflow wind speed: 0.53m/s, declining wind speed: 0.33m/s), if the replacement of the fan, replace the filter after the need to check the wind speed.

Safety cabinet factory before the wind speed has been adjusted in the nominal value, no need to adjust again under normal circumstances. If transported to the place of use after installation and operation, found that the screen shows the wind speed and the nominal value of wind speed is not consistent, please test the actual wind speed value, if found that the actual wind speed value meets the nominal value requirements, need to adjust the screen settings interface at the wind speed and pressure value. If the actual air speed does not match the nominal value, adjust the speed of the fan.

### 1.3.6 Equipment life



Figure 12

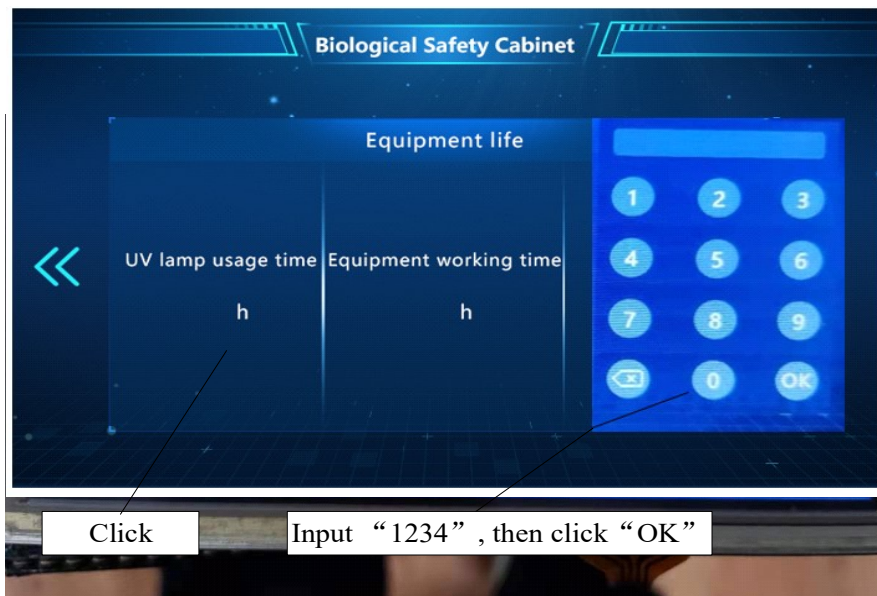

Figure 13

Click on the time in the corresponding area to modify only that area. If you want to adjust the "equipment operating time" and "filter life", click on the corresponding time and enter the password according to the above Figure. If you want to adjust the "equipment operating time" and "filter life", click the corresponding time area and enter the password as shown above.

## 2 Common parts Replacement and Operation

### 2.1 Fuse replacement

Common fuse tube is divided into power insurance, waterproof socket insurance, fan insurance. According to different fuse types, distributed in different locations.

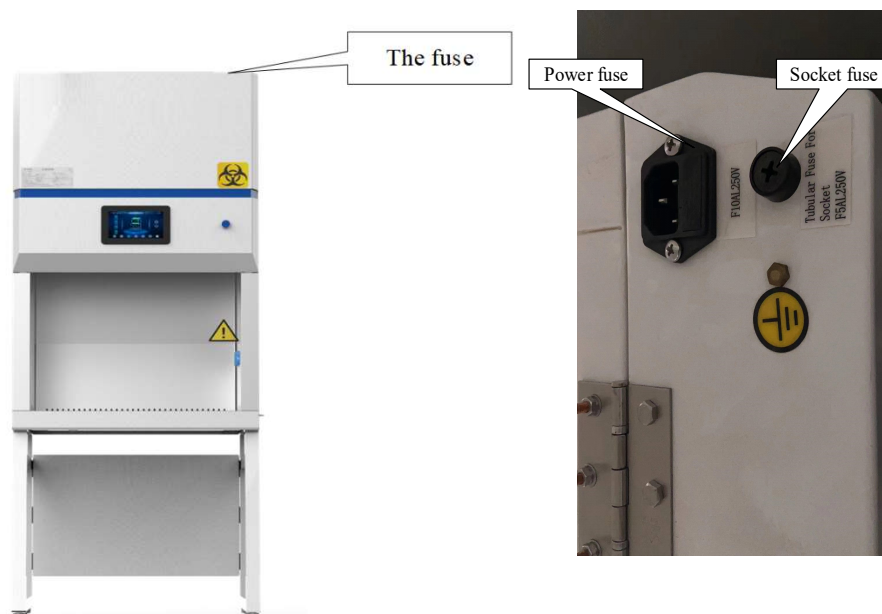

Figure 6

According to the different functions and types of fuse, use a screwdriver or a Phillips screwdriver to remove and install them respectively.



Figure 15

### 2.2 Open the front operation panel

The main control units are concentrated in the operating panel, and the operating panel covers the front of the machine, analysis, solve most of the machine failure must first open the front panel. Specific ways to open the front panel are:

First remove the front panel on both sides of the plug hole plug, and then according to the type



of fixed bolt, select the matching tools, the bolt be removed (if there is the removal process is more laborious, can be suitable for the panel slightly upward to do support), after the removal of the bolt, the panel be turned outward and upward to lift, and use the inner upper support rod in the corresponding position of the cabinet to do support. After the left and right sides of the support rod is fixed, the panel is open.



Figure 16

### 2.3 Power key replacement

Open the operation panel and pull and push the yellow buckle outward as shown in the following figure to disintegrate the key and control components of the power lock. The whole key can be removed by turning the black screw. Remove a power lock of the same model and install it in reverse.



Figure 17

### 2.4 Splash-proof sockets replacement

When replacing the splash-proof socket, simply remove the fixing screw, and replace it as shown in the Figure



The enlarged picture shows the splash-proof socket in the operation area, when disassembling, you only need to remove the 4 screws around the socket (before disassembling and taking out the socket, please make sure the equipment is powered off, and pay attention to the internal wire connection when taking out to avoid disconnecting the wire connection. (The back of "L" is the fire wire interface, "N" is the zero wire interface, "⏏" is the grounding interface)

Figure 18

## 2.5 Replacement of UV lamp and UV lamp ballasts

The UV lamp is in the operation area, when disassembling, just hold both ends of the UV lamp and rotate 90° to remove the UV lamp, the operation is shown in the Figure.



Figure 19

The ballast is fixed in the operation panel, when removing and replacing, remove the corresponding fixing screws, then wiring.



Figure 20

## 2.6 LED Lighting tubes replacement

When replacing the LED lighting tube, first open the front operation panel, tear off the adhesive strip above the LED lighting tube, pull out the power plug in the direction of the red arrow in the following figure, and then remove the lighting tube off outward from the tube clamp. The matching tube be installed in the reverse order of disassembly.



Figure 21

## 2.7 Front window glass Replacement

If you need to replace the front window glass, first open the operating panel, remove the right side of the decorative strip, remove the right PVC glass guide and the pad, remove the glass latch, remove the glass; install the same specifications of the front window glass can be installed, the installation steps to return to resume.

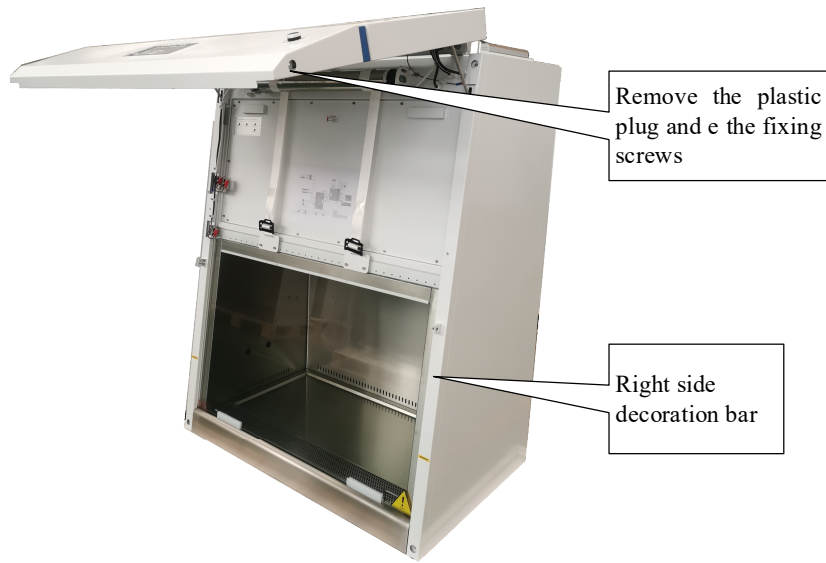

Figure 22

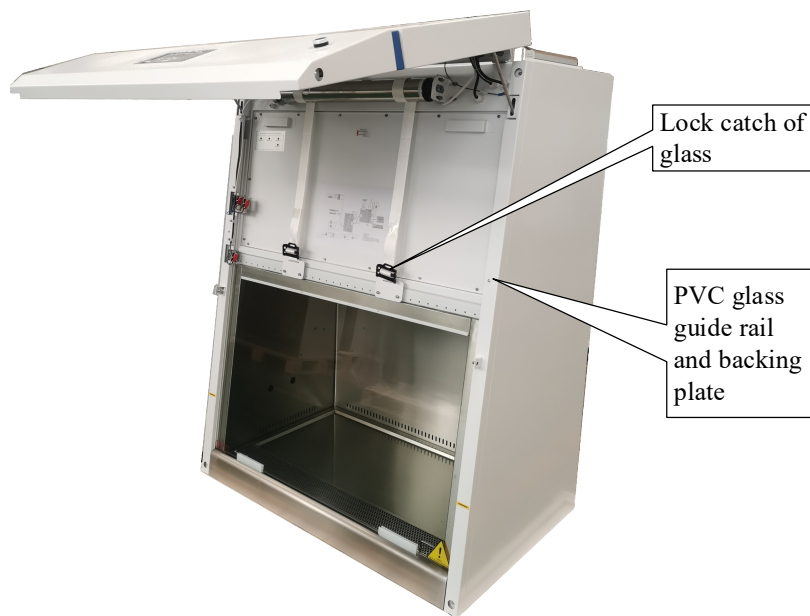

Figure 23

## 2.8 Glass door motor replacement

Glass door motor replacement, first disconnect the conveyor belt, disassemble the spring as shown in the Figure 24, force up the left end of the motor as shown in Figure 25, move to the left to take down the tubular motor, install the same specification glass door motor.

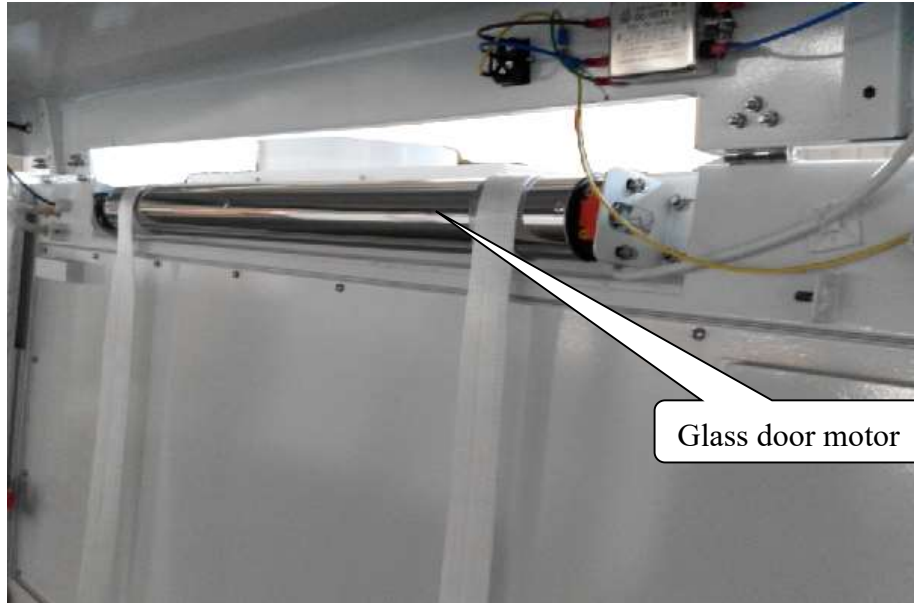

Figure 24



Figure 25

## 2.9 Hygrothermograph replacement

The hygrothermograph is on the air leveling net in the operation area. To replace the hygrothermograph, first remove the bolts on the outside of the air leveling net, and then remove the temperature and humidity sensor and replace it.

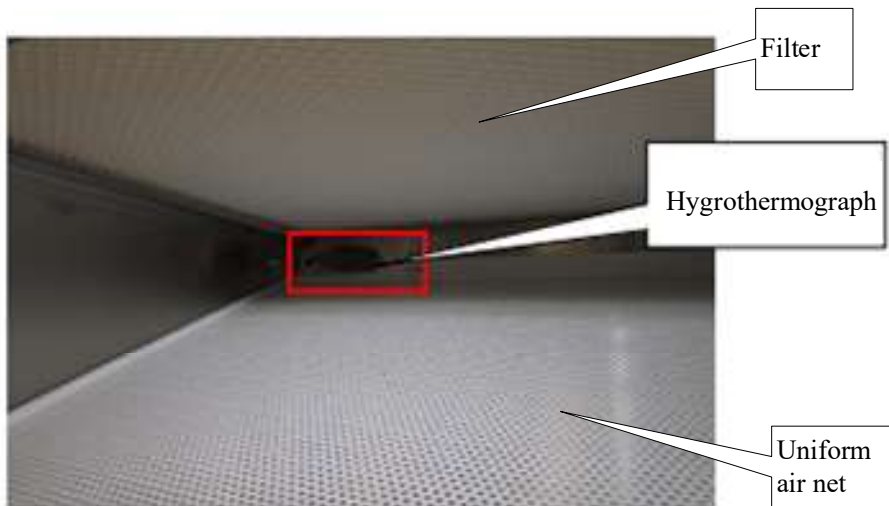

Figure 26

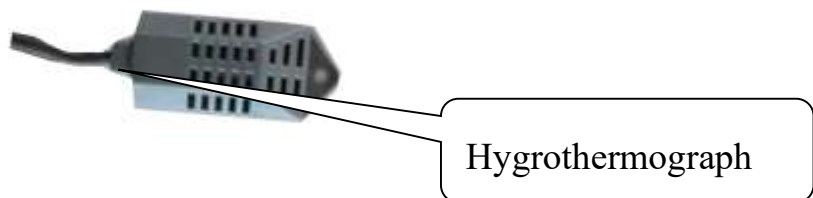

Figure 27

## 2.10 Air tubes replacement

Air tube installation instructions, Figure 28 black represents the front end of the operating panel air tube location, corresponding to Figure 29 on the circuit board sensor air tube location; if there is pressure abnormalities, check and replace the corresponding position air tube.

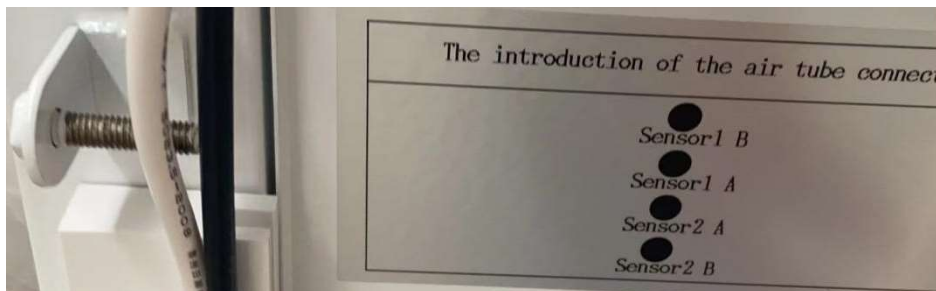

Figure 28



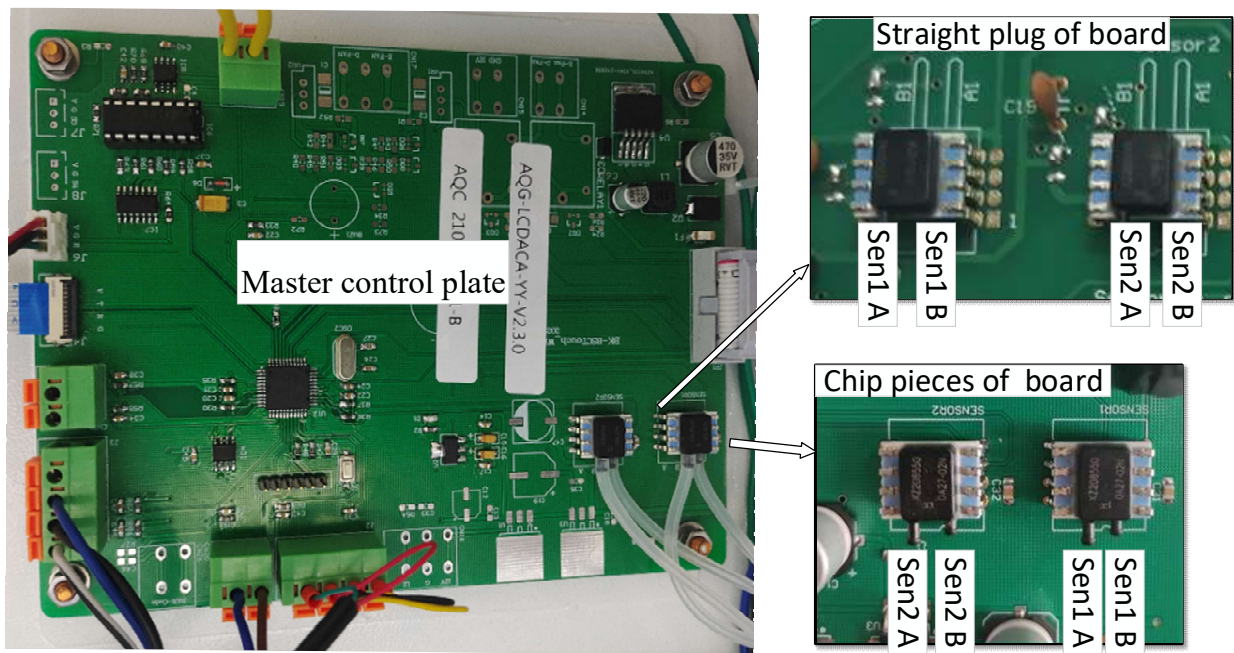

Figure 29

## 2.11 Filter and fan replacement

The operation of filters and fans must be well protected and disinfected.

- 1) Before replacing the filter, the safety cabinet must be fumigated and disinfected

Calculation of formaldehyde, ammonium bicarbonate dosage: the length, width and height of the safety cabinet multiplied by the total volume of the safety cabinet, the total volume multiplied by  $11\text{g/m}^3$ , to determine the mass of formaldehyde required, in order to ensure complete neutralization reaction, ammonium bicarbonate more than 10% of the mass weighed out. Use formalin fumigator (see its instructions for details) to disinfect the interior of the safety cabinet after using ammonium bicarbonate neutralizer to neutralize the remaining formaldehyde gas.

- 2) Must be a good safety protection for the operator

Wear a mask, safety glasses, latex gloves and positive pressure helmet, positive pressure suit and shoe covers. Among them, the mask must be China's high-efficiency filter material made of vinyl chloride mask, its filtration efficiency of up to 99.9%; positive pressure helmet is made of metal and plastic, helmet is positive pressure, to prevent microbial aerosol entry; latex gloves must be set in the lab coat sleeves outside; full-body sealed positive pressure suit is made of impermeable materials, with a ventilation tube or cylinder supply of fresh air, can adjust the temperature and humidity, must be showered and disinfected before use.

Warning: The disassembled filters are hazardous waste and must be disposed of properly and not discarded at . If there are relevant regulations for this waste disposal, they must be strictly followed.

The distribution of filters is shown in the following figure.

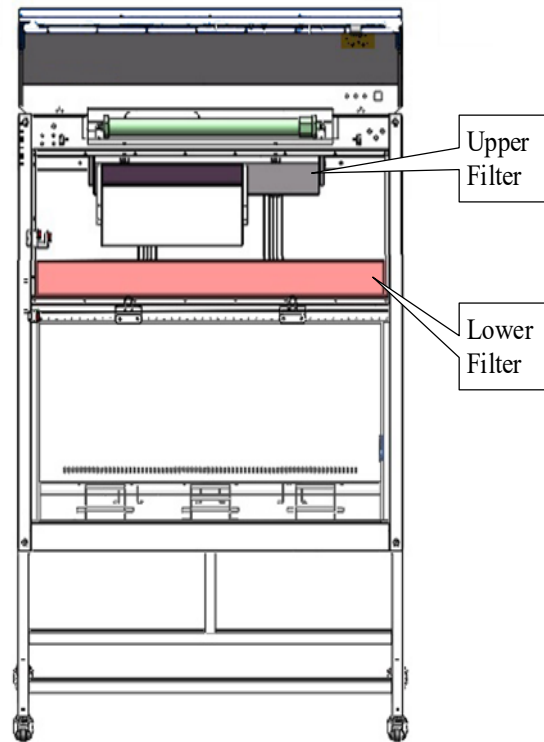

Figure 30

1. Biological Safety Cabinet replacement fan and filter procedure:

a) Place the glass door to the bottom, disconnect the power to the safety cabinet and open the operation panel (see instructions in item 2.2 for the method).

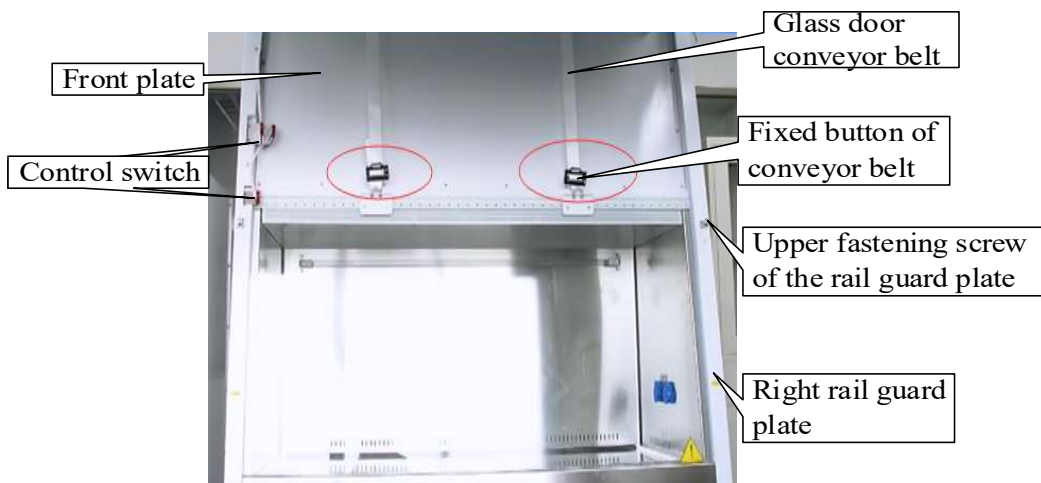

Figure 317

b) Remove the upper fastening screws of the rail guard plate shown in the dotted line frame above (the double-sided adhesive is attached to the bottom surface of the shield. When removing, please swing the guard plate back and forth, and slowly remove the shield from the cabinet);



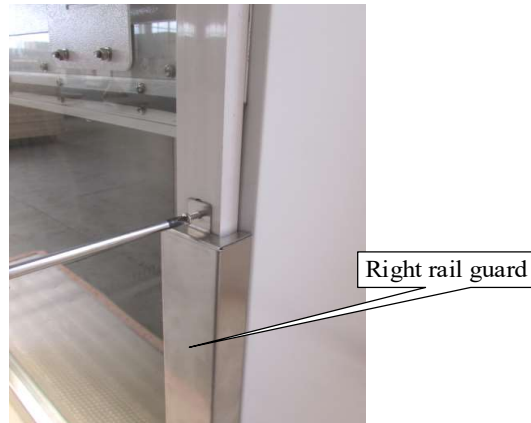

Figure 328

c) Remove the screws on the right side rail, remove the screws on the right side of the glass door as shown in the figure and remove them (be careful to take care when disassembling, to avoid damage due to external force when the glass door is disengaged from the guide groove);



Figure 339

d) Hold the glass door so that it fits close to the cabinet, remove the fixed of the glass door conveyor belt, and loosen the connection between the glass door and the motor, and slowly move the glass door to the right (Note: Remove without damaging the control switch of left glass door).

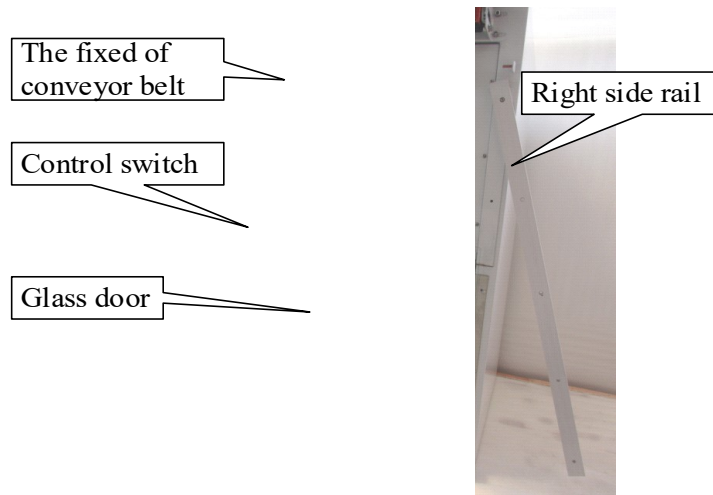

Figure 3410

- e) Remove the front panel as shown in the following figure.



Figure 3511

- f) Remove the front inner panel.

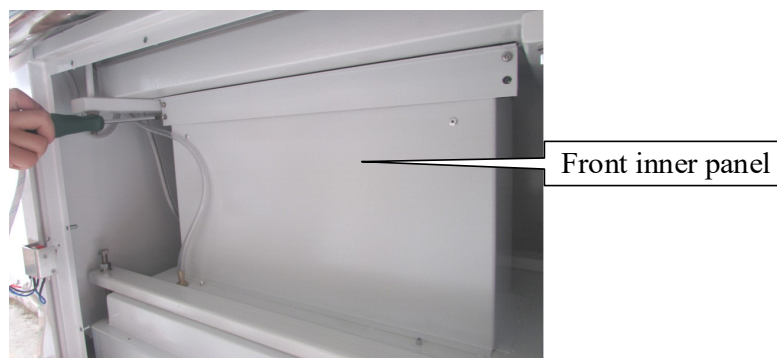

Figure 3612

- g) Decompress the strip and unplug the air tube.

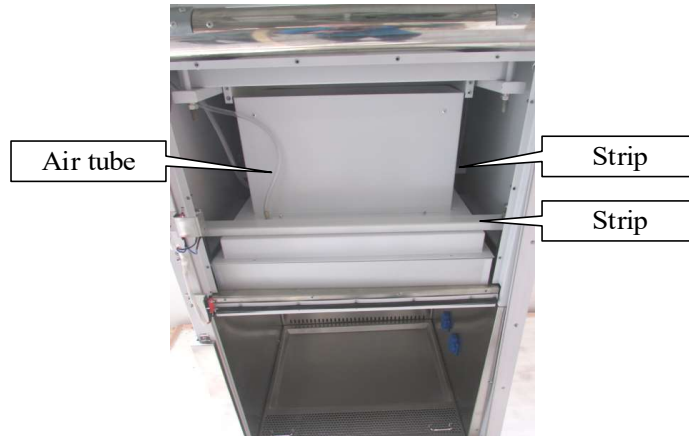

Figure 3713

- h) Horizontally pull out the fan mounting plate.

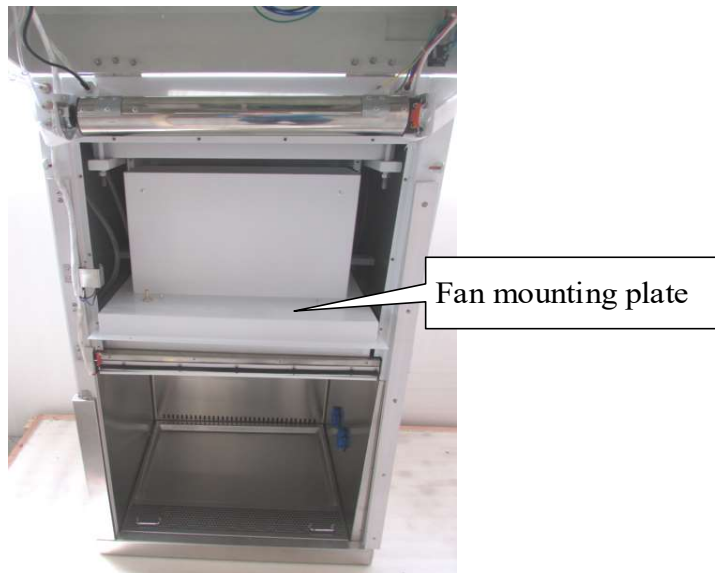

Figure 3814

- i) Remove the back strip.

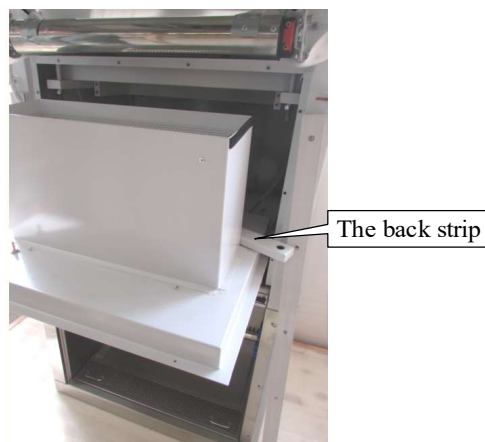

Figure 3915

- j) Remove the lower filter with the arrow pointing down.

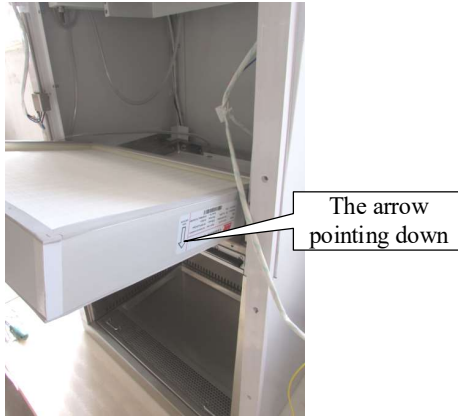

Figure 4016

- k) Remove the top strip.

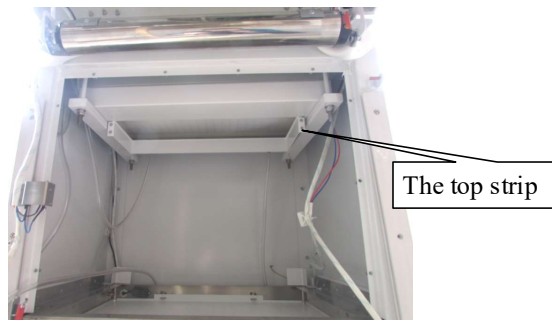

Figure 4117

- l) Remove the upper filter and the upper filter tray.

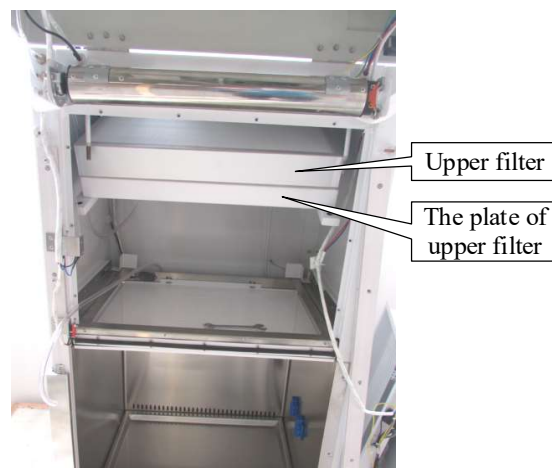

Figure 4218

- m) Push the upper filter strip to the rear position, and remove the upper filter with the arrow pointing up.



Figure 4319

n) Part of the fan mounting plate: Disconnect the power cable of the fan, and remove the nut directly, and replace the fan of the same type. (Note: It is recommended that you take pictures to record the connection sequence of the wires before disconnecting them.)

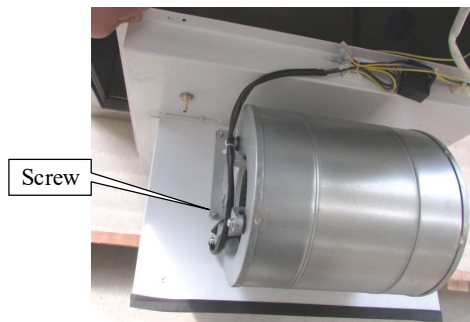

Figure 4420

o) Install the removed parts on the device in reverse order. (Note: Connect cables to the fan by referring to the circuit diagram and the fan body circuit diagram.)

# 3 Equipment Faults and Repairing

## **Fault 1 The device is not energized**

The device is not energized means the device is energized and the power lock is opened, the device does not respond (no alarm, display does not light up, no response from the key).

When dealing with this type of failure, the processing methods and steps are as follows.

1.1 Determine whether the power supply of the equipment is powered and whether it is consistent with the electrical parameters required for normal operation of the equipment. Use a multimeter to determine if the power supply to the equipment is normal.

1.2 The fuse on the fire wire of the power input port of the equipment is equipped with a fuse, which needs to be removed from the power input socket with a flat screwdriver to confirm whether the fuse is fused, if the fuse is fused, please replace the fuse with the fuse of the corresponding label specification.

1.3 After confirming the above items are no problems, open the operation panel (open the operation panel method as shown in Figure 16, use the operation panel support frame (fixed on the inside of the operation panel as shown in the position) to support the operation panel pay attention to safety, power on the equipment, use a multimeter to detect the power lock in the open state input and output voltage (voltage value should be the power supply voltage of the equipment).

1.4 After confirming the above items no problem, try the multimeter to test the transformer input voltage (voltage value should be the equipment supply voltage) and output voltage (see Figure 4), first test with a multimeter AC gear CN9 at the two lines have no voltage, this voltage is the grid voltage. Then test the output voltage of the transformer: use the multimeter AC gear to test the voltage between the two lines at CN10 is between 12V-14V, indicating that this group of voltage output is correct, if the test no voltage, indicating that the transformer is bad, please replace the transformer.

1.5 After confirming that the above items are not problematic, then confirm that the CN11 in the weak board and the CN1 in the strong board are in good contact.

1.6 After confirming that there is no problem with the above items, please replace the control board with a new one.

## **Fault 2 The screen does not light up (normal alarm on)**

The screen does not light up (power on normal alarm) refers to the device power on and open the power lock alarm after all the keys function normally, but the display does not light up no

response. When dealing with this type of failure processing methods and steps are as follows.

- 2.1 Confirm whether the display is broken, if broken, replace the new display board.
- 2.2 Open the operation panel (see Figure 16) and confirm whether the row of wires connecting the display board to the control board has poor contact.
- 2.3 After confirming that there is no problem with the above items, please replace the control board with a new one.

### **Fault 3 Power lock does not respond and the screen does not light up (power-on alarm)**

No response to the power lock and the display does not light up (power-on alarm) refers to the alarm after the device is powered on and the power lock is opened, the key function does not respond and the display does not light up or respond.

When dealing with this type of fault, refer to fault 2 for the processing method and procedure.

### **Fault 4: The machine is not energized**

- 4.1 Measure whether the power outlet voltage is the rated fixed voltage of the equipment, use a multimeter to measure the power outlet voltage value, if there is no voltage, or the voltage does not meet the rated voltage, then you need to communicate with the installation site personnel to deal with, or add adapters or UPS and other equipment.
- 4.2 If the incoming voltage is normal, open the operation panel and measure the incoming voltage at the front of the power switch. Measure the voltage of port 13/23 to see if it meets the power requirement, if not, check the adapter and fuse holder.
- 4.3 If it meets the requirements, turn on the power switch and measure the voltage of 14/24, if there is no voltage, replace the power switch.
- 4.4 If there is voltage, check the strong board, control board, transformer power supply, if there is supply voltage are normal. You need to replace the control board

### **Fault 5: The front window is not at a safe height without alarming**

The front window abnormal non-alarm means that the front window opening is not alarmed when it is not at a safe height (the front window is alarmed when it is super high or below the safe height, i.e. no longer 200mm, and not alarmed when it is completely closed), and the front window automatically stop and stop alarming when it reaches the safe height in the process of

rising or falling.

When dealing with this type of failure, the processing methods and steps are as follows.

5.1 Confirm whether the current window is automatically stopped at the rated height, if it automatically stops but no alarm, it means that the control board needs to be replaced.

5.2 If the glass door can be stopped in other positions, you need to open the operation panel. Use a multimeter to test whether the micro switch is damaged or short-circuited, and whether the micro switch operating lever is in contact with the glass and can be closed. When the glass is at the nominal height, the high switch of the double switch bracket is off and the micro switch of the low switch and single switch bracket is closed (as shown in Figure 46) (When the glass is not at the nominal height, loosen the nut according to Figure 47 and press hard on the travel switch follow the direction of the arrow to move its contacts to the inside, so that the high switch of the double switch bracket is off and the micro switch of the low switch and single switch bracket is closed) . The front window cannot stop automatically when it reaches the safety height can also be detected according to this clause.

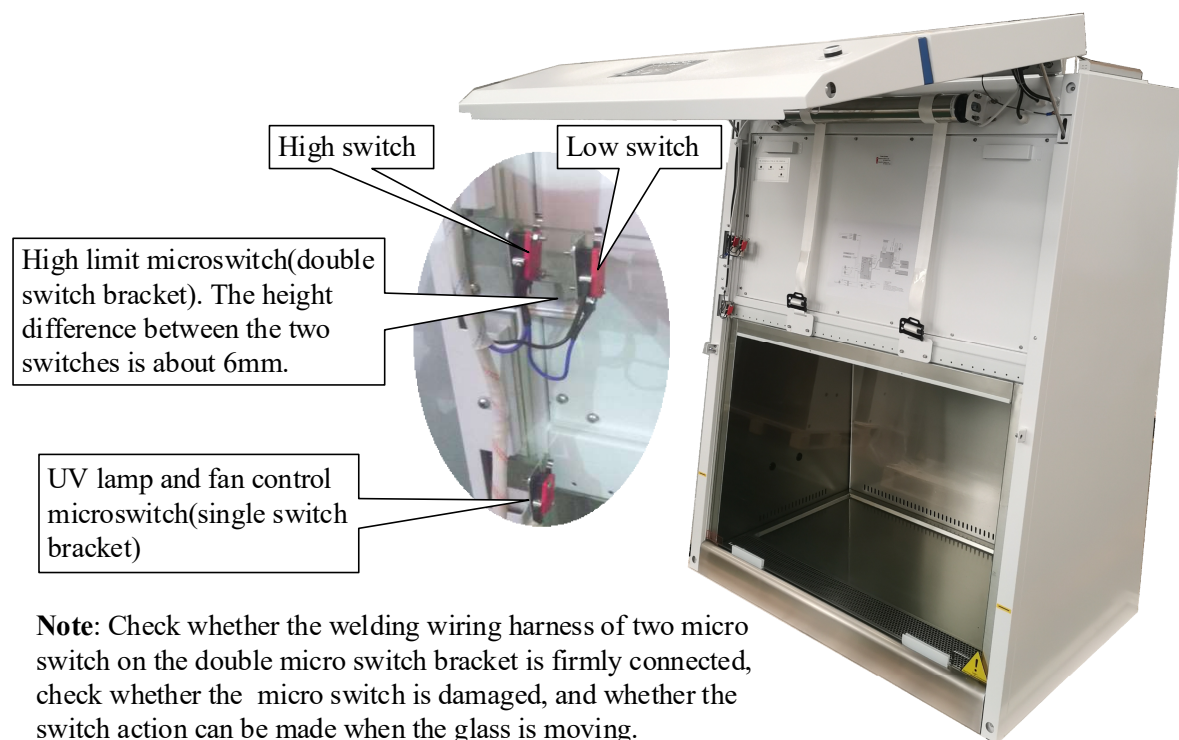

Figure 45



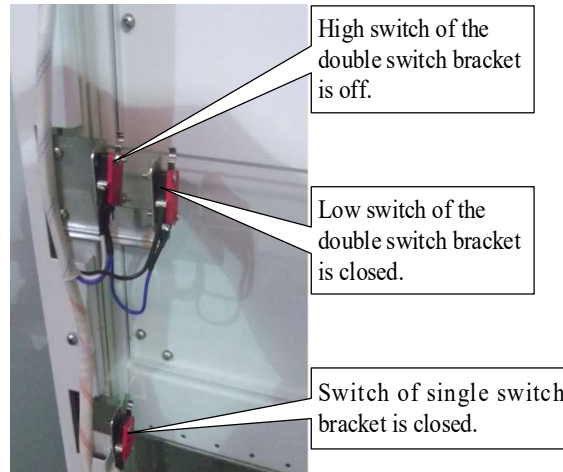

Figure 46

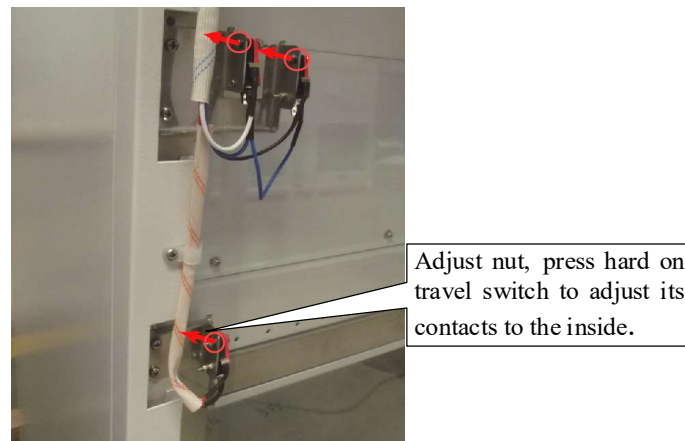

Figure 47

5.3 Confirm that the control board (Figure 3) CN8 terminal block wire is not poor contact, whether the break, double switch bracket high switch to CN8 at H, low switch to CN8 at L. The switch of the single switch bracket is connected to CN10 in Figure 4.

5.4 After confirming that there is no problem with the above items, please replace the control board with a new one.

## Fault 6 Front window lift failure

Front window lift failure is when the front window glass door does not move when pressing the up and down key.

When dealing with this type of failure, the processing methods and steps are as follows.

### 6.1 Operation panel keys do not work

Open the operation panel. Equipment power and power lock open, start the power key, press and hold the upper key to use the multimeter to detect the strong board (Figure 4) CN1 terminal blue (white) line and brown (red) line between the voltage (voltage value should be the power supply

voltage of the equipment), press and hold the lower key to use the multimeter to detect the strong board CN1 terminal blue (white) line and the voltage between the black line (voltage value should be the power supply voltage of the equipment), if there is no voltage If there is no voltage, the control board is damaged, replace the control board. If the above normal, respectively, the motor brown (red) line and blue (white) line or black line and blue (white) line directly to the power supply, if there is glass door motor no action, glass door motor damage, replace the glass door motor (glass door motor location as shown in the follow figure).

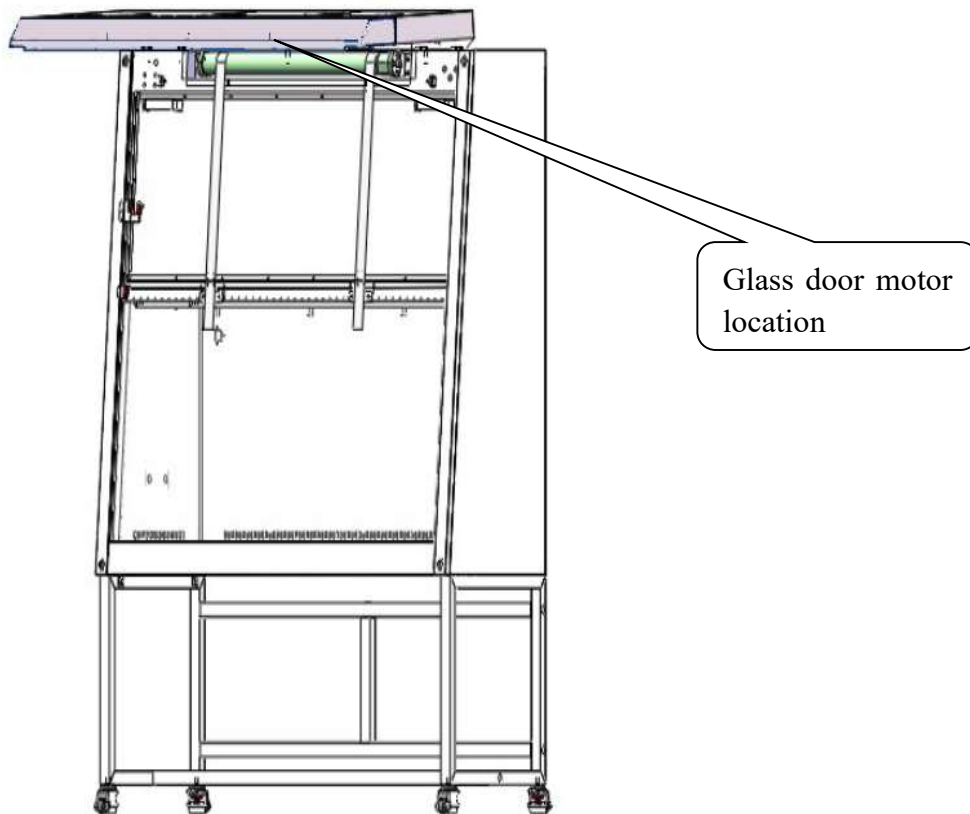

Figure 48

## 6.2 Remote control keys do not work

Confirm whether the remote control battery has power or replace the remote control battery, if the remote control key does not work after replacing the battery, the remote control is damaged, replace the new remote control. Otherwise, according to 6.1 instructions in order to test the judgment.

## Fault 7 Remote control failure

Remote control malfunction means that the keys on the remote control do not work.

Confirm whether the remote control battery has power or replace the remote control battery, if the remote control key does not work after replacing the battery, the remote control is damaged, replace the new remote control. If the new remote control still does not work, the whole set of circuit board is damaged, replace the whole set of circuit board.

## Fault 8 No power in the operating area socket

No power to the operating area receptacle means no power to the splash-proof receptacle in the operating area when the receptacle key is activated.

The methods and steps to deal with this type of failure are as follows.

8.1 Check if the fuse (see fuse replacement) of the operating area socket is fused. If the fuse is fused, replace the fuse with one that corresponds to the labeling specifications.

8.2 After confirming that there is no problem with the above items, disassemble the splash-proof socket in the operation area, press the socket key, use a multimeter to measure the voltage of the connected socket wires (the voltage values should all be the power supply voltage of the equipment) and determine if there is any damage inside the socket. If the voltage of the connecting socket wire is normal and the splash-proof socket is damaged, replace the splash-proof socket.



Waterproof Sockets  
Cut off the power before removing the socket

Figure 49

8.3 After confirming the above items are no problem, open the operation panel. Use a multimeter to detect whether the socket line is disconnected, if there is disconnected reconnected can be, socket line to the strong power board CN4 (Note: the above test whether the wire is disconnected please operate in the device power off state).

8.4 If the above-mentioned no problem, power on the device power lock open, press the power key and socket key in turn, observe whether the socket icon on the display lights up, if not, the control board or display board is damaged, please replace the new set of circuit boards.

8.5 If the above-mentioned no problem, the device is powered on and the power lock is open, press the power key and the socket key in turn, use a multimeter to detect whether the CN4 terminal block on the power board has voltage (voltage values should be the power supply voltage of the device), if there is no power, the control board is damaged, replace the control board.

## **Fault 9 Lighting does not light up**

The lighting does not light up is when the lighting does not light up after starting the lighting key.

When dealing with this type of failure, the processing methods and steps are as follows.

9.1 Confirm whether the light holder at both ends of the light is in good contact, remove the light to confirm whether the body of the tube on both sides of the light becomes dark, if there is darkening the lighting light is damaged, the bright light.

9.2 If the above-mentioned no problem, open the operation panel, the equipment is powered on and the power lock is open, press the power key and lighting key in turn, use a multimeter to detect the voltage of the CN5 terminal block of the power board (voltage values should be the power supply voltage of the equipment), if there is no voltage, the control board is damaged, replace the new control board.

9.3 If there is no problem above, comb the wire between the lighting and the strong board to check whether the connection is loose, if there is loose, reconnect the loose wire; if not conductive, it is necessary to replace the new wire.

## **Fault 10 UV lamp does not light**

The UV lamp does not light up is when the UV key is activated and the UV lamp does not light up.

The methods and steps to deal with this type of failure are as follows.

10.1 Verify that the front window glass door and fluorescent light are completely closed. If they are not completely closed, the UV lamp not start. If it is closed, please follow the subsequent steps to check.

10.2 Confirm that both sides of the light foot and the light holder is in good contact, remove the light to confirm that both sides of the light filament is broken, if there is broken, UV lamp damage, replace the same specification UV lamp (UV lamp location see Figure 19). After the UV lamp is replaced, the usage time of the UV lamp needs to be zeroed out, and see 1.3.6 Equipment life.

10.3 If there is no problem, open the operation panel and check whether the control UV interlock control switch is in the disconnected state (as shown in follow figure) and whether its wire is damaged, this switch is connected to the control board "CN10".

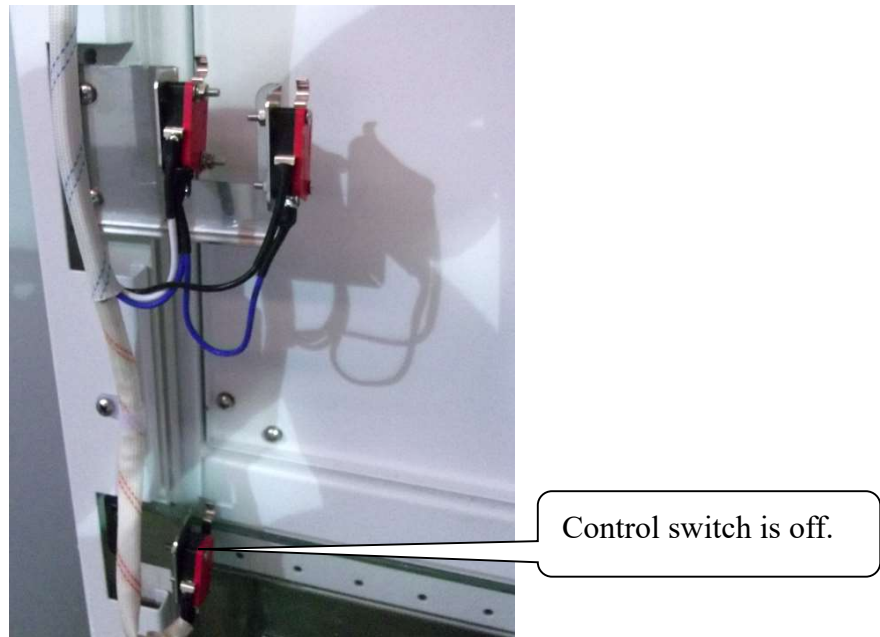

Figure 50

10.4 If the above-mentioned no problem, the device is powered on and the power lock open, press the power key and UV key in turn, use a multimeter to detect the voltage of the strong board (Figure 4) CN6 terminal block (voltage values should be the power supply voltage of the device), if there is no voltage, the control board is damaged, replace the new control board.

10.5 If there is no problem above, comb the wire between the UV lamp and the UV lamp ballast, the connection wire between the UV lamp ballast and the control board. Check whether the connection is loose, if there is loose, reconnect the loose wire (ballast position refer to Figure 20).

10.6 If the above no problem after the ballast is damaged, replace the new UV lamp ballast of the same specification.

## **Fault 11 Fan does not work**

The fan does not work is when the fan does not start after the fan key is activated.

The methods and steps to deal with this type of failure are as follows.

11.1 (Note: The factory settings when the front window glass down to the bottom of the fan does not start), the device is powered on and the power lock is open, press the fan key, check whether the fan icon on the display lights up. If not lit, open the operating panel (see 2.2 instructions), check whether the UV lamp interlock micro switch is closed or its connecting wire is damaged, if there is damage or failure, replace the control switch or reconnect the wire or make the switch closed. If lit, use a multimeter to test the voltage of the CN2 terminal block of

the heavy current board (Figure 4) (this voltage is between 120V-200V for the internal fan, the grid voltage of 110V be lower than this value),

11.2 If the above-mentioned no problem, respectively, the fan is directly connected to the power supply of the equipment, observe whether the fan starts, if not, the fan is damaged, replace the same type of fan (replace the fan steps refer to the following replacement fan method). The inner fan line is connected to the strong power board "CN2".

11.3 If there is the above no problem after combing to detect whether the fan and circuit board connection wire is connected to loose or broken, if there is loose or broken connection, reconnect the wire.

## Fault 12 Differential pressure and wind speed showing not in rated range

12.1 Before adjusting the air speed, check whether the air guide tube has been folded.

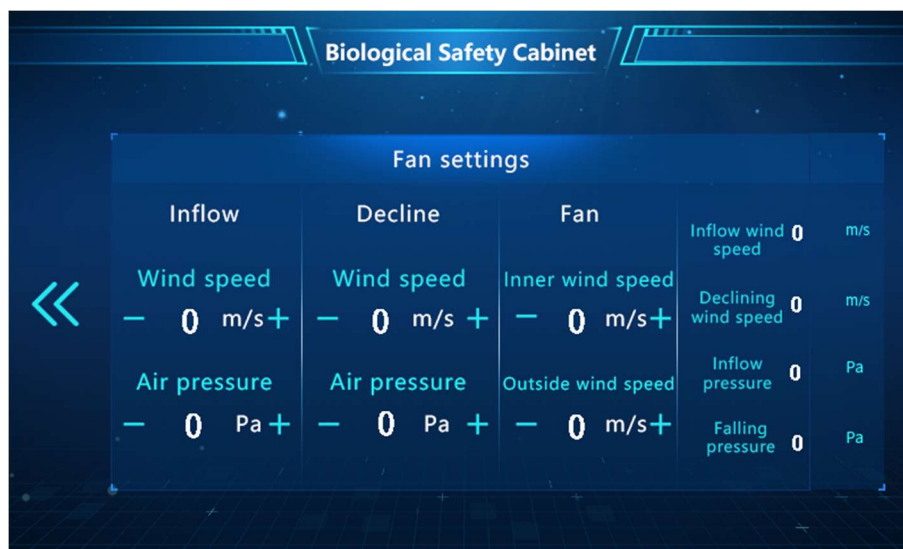





Figure 51

Turn on the fan, wait for the fan to work for about 5 minutes, and click the screen setting key



to enter the setting interface. Select "Fan settings" , and enter the password: 1234(or 1111) in this interface to enter the fan commissioning interface. According to the wind speed and air pressure requirements(Note: The wind speed setting range is generally 0.53m/s for declining wind speed and 0.33m/s for inflow wind speed. Safety cabinet inflow and declining pressure range is between 80-110Pa.), and adjust the "Inner wind speed" respectively (A2 type only need

to adjust the inner fan, B2 type need to adjust the inner and outer fan), press  to decrease speed, press  to increase.

12.2 Pressure setting.

Safety cabinet upper and lower filter pressure between 80-110Pa, if the pressure is out of range

need to be adjusted, the pressure in the range does not need to be adjusted.

After adjusting the “Inner wind speed”, adjust the “Air pressure” of "Inflow" and "Declining" respectively, and increase and decrease the corresponding numbers by +/- . The rightmost area is the final scree data, the data will be adjusted to the inspection requirements.

### 12.3 Wind speed setting.

The wind speed setting range is generally 0.53m/s for down wind speed and 0.33m/s for inflow wind speed.

After adjusting the “Inner wind speed”, adjust the “Wind speed” of "Inflow" and "Declining" respectively, and increase and decrease the corresponding numbers by +/- . The rightmost area is the final scree data, the data will be adjusted to the inspection requirements.

**Note:** If the pressure is displayed within the normal range, turn on the fan and adjust the wind speed directly, without adjusting the pressure.

If the "Inner wind speed" of “Fan” is re-adjusted, you need to reconfirm whether the inflow/decline pressure and wind speed meet the range.

## Fault 13 Warning Filter differential pressure is super high

When the voice announcement indicates that the pressure is too high and the filter needs to be replaced, first check the actual use time of the filter, if the use time is close to the rated life, it needs to be replaced, and after the replacement is completed, the filter timing be cleared to restart the timing. Specific filter replacement operations are described in the "2.11 Filter and fan replacement" operation.

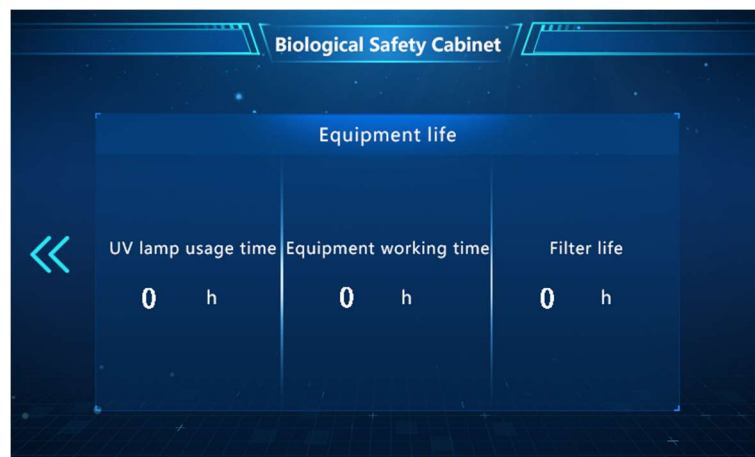

Figure 52

## Fault 14 Front window glass broken

Explosion-proof glass used in the front window glass, if the safety cabinet in the use of glass breakage, should promptly stop the experiment, timely replacement. And clean up the scattered glass fragments, and when moving need to avoid directly lifting the broken position to avoid

secondary breakage. Specific replacement operation see "2.7 Front window glass replacement".

### **Fault 15: Clock display adjustment**

The clock usually require readjustment when the control board battery is replaced. If the battery power is exhausted, when the battery is newly installed, the clock must be adjusted, when adjusting, click on the time display area in the upper right corner of the main screen, in the window that emerges, enter the "year - month - day - hour - minute - second" data in turn, when entering the input bit number and display the same bit. See "Screen Settings - Time Settings" for details.

### **Fault 16: Glass door rise fault**

The glass door in its normal state is vertical up and down, glass door operation abnormalities are common in three cases: 1, the glass door tilt when rising or falling; 2, the glass door can not continuously rise or fall; 3, the glass door does not move. Specific analysis and processing methods are as follows.

16.1 If the glass door tilts during the rising process, first check whether the glass door fixing belt is loose, run the glass door to the lowest end, check whether the white fixing belt is too loose and whether the fixing length is consistent, you need to adjust the glass locking buckle and adjust the fixing belt to the same length.

16.2 If the fixed belt does not need to be adjusted, check whether the PVC guide is obstructed by foreign objects and so on, if there is a need for timely cleaning.

16.3 If the glass door still has problems, you need to replace the door motor, the specific replacement method see "2.8 Glass door motor replacement".

### **Fault 17: Temperature and humidity display is incorrect**

The upper left corner of the display screen shows the temperature and humidity of the sensor area (temperature and humidity sensor location as shown in the Figure). First determine the actual indoor environmental values, the actual temperature and humidity values in the operating area. If the operation and the actual measured value and the display value of the discrepancy, troubleshooting as follows.

- 1) Check whether the temperature and humidity sensor wiring is off and poor contact, "H, GND, VCC, T" at "CN11" of the control board.
- 2) Check for the temperature and humidity sensor is faulty, replace the sensor of the same type, the sensor location in the work area above the even air network, remove the even air network can be seen, as shown in the figure.



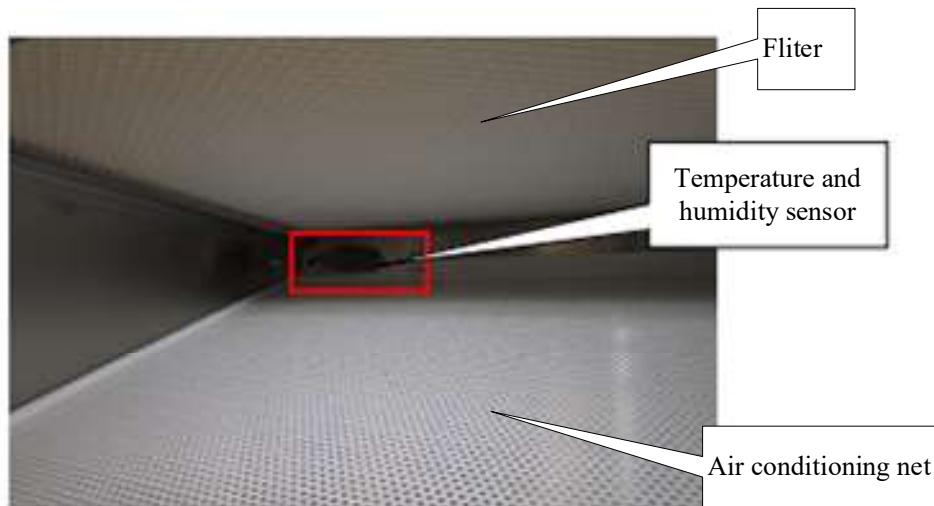

Figure 53

If the above are no problems is the circuit board failure, you need to replace the circuit board.

### Fault 18: Abnormal air pressure display

The air pressure display value of the upper and lower filter, if the air pressure value appears abnormal, the specific analysis and processing steps are as follows.

18.1 First check if the filter should be replaced (see Filter Alarm for filter replacement).

18.2 If the filter does not need to be replaced, check whether the pressure sensor is faulty in the chip on the control board, according to the following figure, 1 is the upper filter and 2 is the lower filter. One end can be manually plugged or pressurized to determine whether the pressure changes, if there is normal changes, check the air pipe or fan, if there is no change, the control board needs to be replaced.

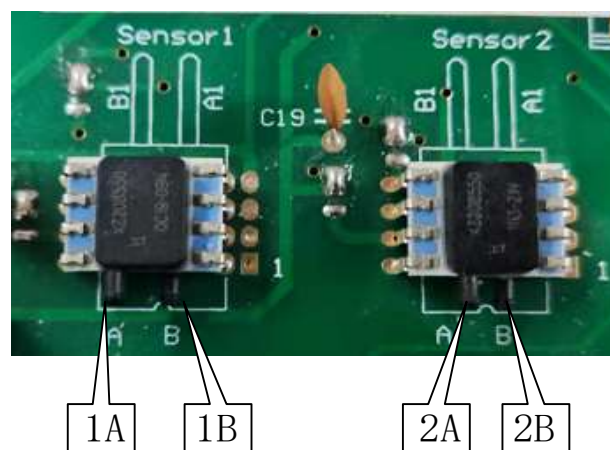

Figure 54

18.3 Air tubes installation instructions, and replacement, see "2.10 Air tubes replacement" for details

## **Fault 19: Inflow wind speed is zero, declining wind speed is zero**

19.1 When the inflow and declining of wind speed is zero, first determine whether the fan is running, and the fan running relative to the shutdown when there is a significant difference in vibration and noise, refer to the fault 11 to deal with. If the fan is confirmed to be damaged, the fan needs to be replaced in time, see "2.11 Filter and fan replacement" for details.

19.2 If the fan is running normally, check whether the air guide tube is folded, open the operation panel and restore the folded air guide tube.

19.3 If the air duct is not bent, you need to check the wind speed setting in the fan setting interface to see the actual wind speed setting (see 1.3.5 Fan setting for details). If the setting cannot be set or the setting is faulty, then the control board needs to be replaced.

# Appendix: Wiring Schematic Diagram

