

LORDERAN

CLIMATE CHAMBER

USER MANUAL

LORDERAN

First of all, thank you for choose lorderan climate chamber and your strong support for our cause!

Market competition and product quality requirements have promoted the development of environmental research. In turn, the progress of environmental research has promoted the improvement of material product quality.

Fortunately, Chinese enterprises have realized that the environmental adaptability test of products is an important means of product quality assessment, and the feedback of environmental test results is an important basis for improving product quality - in fact, environmental test has become a necessary procedure for enterprises to assess product quality.

In terms of the research and development of environmental adaptability test equipment, we follow the objective laws and carefully make it with strict standards. Thus, the determination, reliability and practicability of the equipment are guaranteed.

In order to enable your company to quickly understand and correctly use this series of equipment, we carefully prepare this manual.

1. When you use this series of equipment, please read it fully and follow the safety precautions and operation methods listed in the manual to prevent damage to this series of equipment and ensure the safety of use and the reliability of test results.
2. All products of our company have undergone strict quality control inspections and are allowed to leave the factory only after passing all technical indicators.
3. If you have any questions or needs during use, please contact our after-sales service personnel in time. We will give you a satisfactory reply as soon as possible.

Chapter 1

Precautions for use

This chapter describes precautions for safe use of the climate chamber. In order to prevent accidents to users, equipment and specimens, please read this chapter carefully and follow the relevant regulations.

1.1.1 Test Chamber Safety knowledge

A. The shell of the test chamber must be grounded when installed. If the test chamber is not grounded, there will be a risk of electric shock in the event of leakage.

B. Do not operate the equipment before it is installed. Make sure the installation is reliable before conducting the test.

C. If a heating sample is placed in the inner chamber, please use an external power supply for the sample control power supply. Do not use the local power supply directly.

C. The operation of the test chamber will produce dangerous current. Non-professionals are not allowed to open the cover of the electric control cabinet.

D. If the test chamber is not equipped with a humidification function, pay attention to the differences in usage and requirements when reading the instructions.

E. Various motors and fans are started according to the instructions under the control of the controller, when the machine is running. Do not touch the components that are temporarily stationary with your hands to prevent the components from suddenly starting and causing personal injury. It is indeed necessary to get close to the rotating parts. When working on the machine, please cut off the main power switch and ensure that the protective device is intact.

F. It is forbidden to move the test chamber when there is a sample inside, otherwise the sample may reverse or fall.

G. The test chamber must be installed horizontally, otherwise it will cause an alarm or unstable humidity control.

H. Before use, make sure the test chamber is fixed well, the adjustment feet are on the ground. Otherwise, the test chamber may move unexpectedly when external force is applied.

J. Please read the safety requirements in the instructions and the safety labels on the equipment carefully before using the box test.

1.1.2 Substances that cannot be placed in the test chamber

This test chamber must not be used for testing the following substances or containing these substances:

- Explosive

A. Nitroglycol (ethylene glycol dinitrate), nitroglycerin (glycerin trinitrate), nitrocellulose and other explosive nitrates.

B. Trinitrobenzene, trinitrotoluene, trinitrophenol (picric acid) and other explosive nitro compounds.

C. Peracetic acid, methyl ethyl ketone peroxide, benzoyl peroxide and other organic peroxides.

- Combustibles

A. Spontaneous combustion materials:

Metals: lithium, potassium, sodium, yellow phosphorus, phosphorus sulfide, red phosphorus.

Celluloid: calcium carbide (carbide), phosphate lime, magnesium powder, aluminum powder, sodium bisulfite.

B. Oxide properties:

a. Potassium chlorate, sodium chlorate, ammonium chlorate and other chlorates.

b. Potassium peroxyacid, sodium peroxyacid, ammonium peroxyacid and other peroxyacid salts.

c. Potassium peroxide, sodium peroxide, barium peroxyacid and other inorganic peroxides.

d. Potassium nitrate, sodium nitrate and other nitrates.

e. Potassium hypochlorite and other hypochlorites.

f. Sodium chlorite and other chlorites.

- Alkene

A. Ether, gasoline, acetaldehyde, propylene oxide, carbon disulfide and other substances with a ignition point less than -30°C .

B. Ordinary ethane, ethylene oxide, acetone benzene, methyl ethyl ketone, methyl ketone and other substances with a ignition point above -30°C but less than 0°C .

C. Methanol, ethanol, xylene, amyl acetate and other substances with flash points

LORDERAN

above 0°C and below 30°C.

D. Kerosene, light oil, turpentine, isoamyl alcohol, acid vinegar and other substances with a ignition point above 30°C and below 65°C.

- Combustible gas

Hydrogen, acetylene, ethylene, methane, ethane, propane, butane and other flammable gases are in gaseous state at a temperature of 15°C or a pressure of one atmosphere.

1.2、 Test Chamber Precautions

- 1) During operation, please do not open the door unless absolutely necessary, otherwise it may cause the following adverse consequences.
 - a. The high-temperature airflow rushes out of the box... Very dangerous
 - b. The inside of the box door still maintains high temperature...Causing burns
 - c. High-temperature air may trigger fire alarms and cause malfunctions.
- 2) Please make sure the door is closed tightly when the equipment is running. Before opening the door, pay attention to the internal temperature of the box to avoid burns or frostbite.
- 3) Avoid turning on/off the refrigeration unit repeatedly within fifteen minutes.
- 4) The circuit breaker and over-temperature protector provide safety protection for the test product of this machine and the operator, so please check it regularly.
- 5) All samples should be placed evenly, and the placement of the samples should be ensured within the effective space of the studio.
- 6) When plugging or unplugging the communication interface cable between the test chamber and the computer, the power of the computer must be turned off first. Hot plugging and unplugging are never allowed. Hot plugging and unplugging may damage the controller or the communication module of the computer.
- 7) When placing high-temperature samples for low-temperature testing, attention should be paid to: The time for opening the door should be as short as possible.。
- 8) Do not cut off the power supply when the device is running at high temperatures, especially if there is a thermal load inside the device. This can easily cause local overheating, causing parts in the equipment to burn out.
- 9) For test chambers with lighting functions, the lights should not be on all the time.。
- 10) After the test is completed, do not open the studio door immediately to avoid the impact of cold steam or hot steam on the operator. If the test sample must be taken out immediately, insulating gloves must be worn to avoid burns or frostbite.
- 11) After the test work is completed and the test chamber is not in use, be sure to turn off the main power switch to prevent accidents such as lightning strikes.

Chapter 2

Application

This chapter describes the purpose of the climate chamber, the principle of temperature and humidity control and the refrigeration system, Also the working principles of other parts are provided to facilitate customers to have a corresponding understanding of the working principles of the equipment.

2.1、 application

The climate chamber is suitable for performance testing of various electrical components, instruments, meters, raw materials, coatings, etc. under different temperature and humidity environmental conditions. It can also be used as an adaptability test for storage and use in different temperature environments. It is an ideal choice for aviation, automobiles, etc. Necessary testing equipment in , home appliances, scientific research and other fields.

2.2、 Temperature and humidity control system

The temperature and humidity control system balances the temperature and humidity in the box to create the required environment. This is achieved by continuously controlling the power of the evaporator (dehumidifier), heater, and humidifier in real time. The cooler continuously releases cold energy to offset the temperature of the sample. fever. Its core is the temperature and humidity controller, and the display is just a user interface.

The so-called TMHM control system uses a temperature (humidity) regulator to continuously control the heater and humidifier with small heat capacity while continuously operating the evaporator (and dehumidifier) with large heat capacity, adjusting the capabilities of each equipment in real time and balancing the overall temperature and humidity to create a system with the temperature and humidity requirements required for the test.

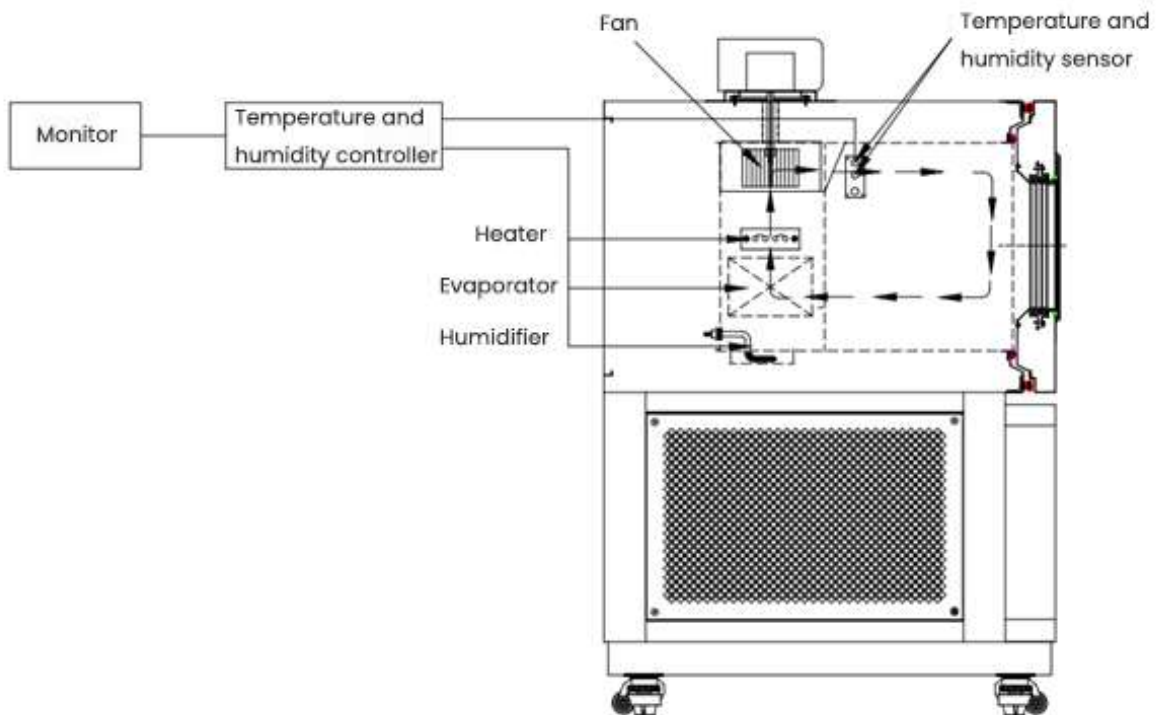

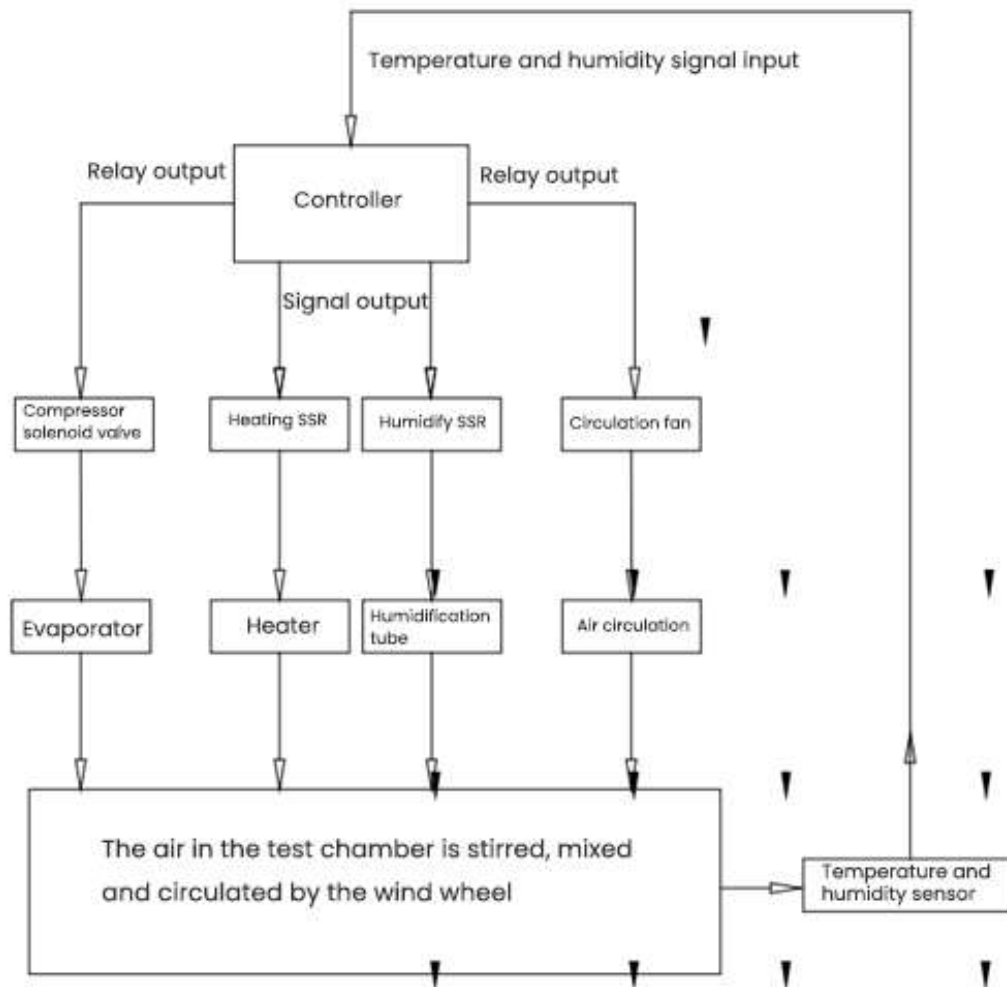

P 1(2) Balanced temperature and humidity regulation principle diagram

2.3、Refrigeration system

The refrigeration system consists of a compressor, air (water) condenser, pressure accumulator, filter dryer, solenoid valve, capillary tube, pressure protection and evaporator, etc.

Both high and low temperature refrigeration cycles adopt the reverse Carnot cycle. The refrigeration process is as follows: the refrigerant is adiabatically compressed to a higher pressure by the compressor, and the work consumed by the compression causes the temperature of the refrigerant to rise. Afterwards, the refrigerant conducts heat exchange with the air isothermally through the condenser, and transfers heat to the medium. Next, the refrigerant expands adiabatically through the expansion valve, and the temperature of the refrigerant decreases. Finally, the refrigerant absorbs heat

isothermally from the higher temperature object through the evaporator, causing the temperature of the object to be cooled to decrease. This cycle repeats itself to achieve the effect of cooling the chamber.

The refrigeration cooling methods of this series of products are divided into air cooling and water cooling. The refrigeration methods are divided into single machine refrigeration and double machine cascading refrigeration. The instructions are air, Water-cooled, single machine, cascade universal type. When reading the instructions, please distinguish the usage and requirements according to the machine model.

The equipment produced by our company is all fluorine-free and environmentally friendly refrigerant. The single-machine equipment uses R404A refrigerant. The double-machine cascade refrigeration uses two refrigerants, high-temperature grade R404A and low-temperature grade R23.

2.4、 Dehumidification system

This equipment dehumidifies based on the principle of condensation dehumidification. When the refrigeration system is working, the temperature of the fins on the evaporator surface will be lower than the dew point temperature of the test temperature and humidity. When the air circulates, moisture will condense when passing through the evaporator surface, thus achieving Dehumidification purpose.

The dehumidification system is a single-machine compression refrigeration cycle. The system consists of a compressor, air (water) condenser, pressure accumulator, filter dryer, solenoid valve, capillary tube and evaporator.

2.5、 Heating system

The heating system consists of air heating wire, heating control system, air circulation, etc.

The heating system generally uses nickel-chromium alloy electric heating wires for direct heating. When the equipment is working, the circulating fan causes convection of the air in the box and takes away the heat generated by the heating wire, thereby achieving the effect of heating the air in the box; the control system is adjusted by a microcomputer. Control the conduction time of the heating wire to achieve a dynamic balance between heating heat and loss heat to achieve precise temperature control.

2.6、 Humidification system

The humidification system consists of electric heating pipes, humidification control system, air circulation system, water supply system, drainage system, etc.

The humidification system is a direct humidification method with electric heating tubes. When the equipment is working, the circulating fan causes convection of the air in the box, takes away the steam generated by the humidification tube, and achieves the effect of humidifying the air in the box through air circulation; the control system is adjusted by a microcomputer to control the humidification. The conduction time of the tube, the amount of humidifying steam and the amount of steam lost (mainly the amount of steam dehumidified by the evaporator and the amount of condensed steam) achieve a dynamic balance to achieve precise humidity control.

Chapter 3

Overall structure

This chapter generally describes the box structure of the test equipment and the functions of the control panel, distribution cabinet, water circuit system and components in the test chamber, so that users can have an understanding of the overall structure of the equipment and the functions of each part.

3.1、Climate chamber front view

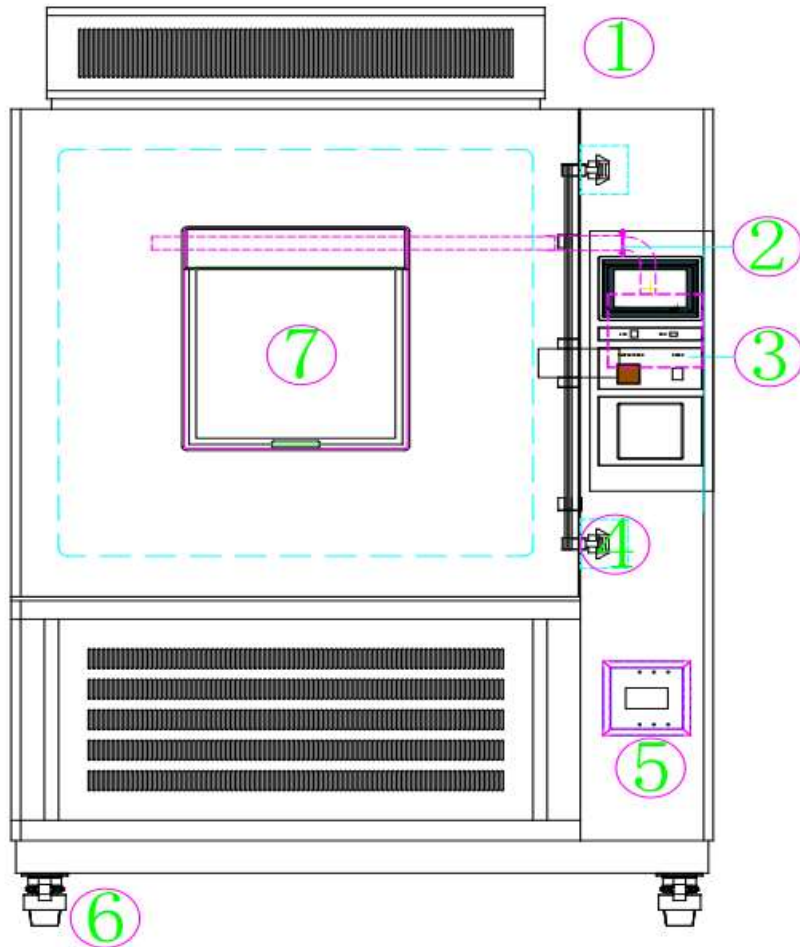

No.	Name	Purpose
1	Motor cover	Protect the motor
2	Outlet tube	Send the steam from the boiler to the box
3	Controll Panel	Controller
4	Handle	Open/close the door
5	Drawer	Filling the water tank
6	Wheels	Fixed adjustment the position and level
7	Window	Observe the test product in the chamber

3.2、Climate chamber left view

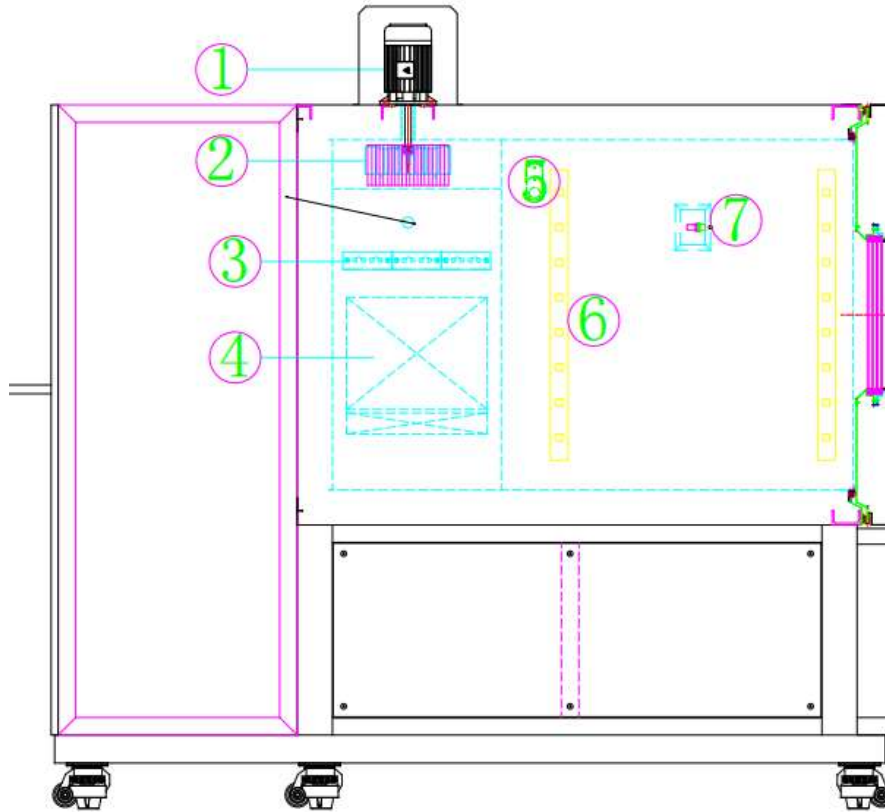

No.	Name	Purpose
1	Motor	Drive wind drum
2	Drum	Rotate to circulate the air inside the box
3	Heater	Heating
4	Evaporator	Dehumidification or cooling
5	Sensor	Transmit the real-time temperature and humidity of the box to the controller
6	Rack	Place sample racks at different heights
7	Light in the chamber	Lighting

3.3、 Internal structure

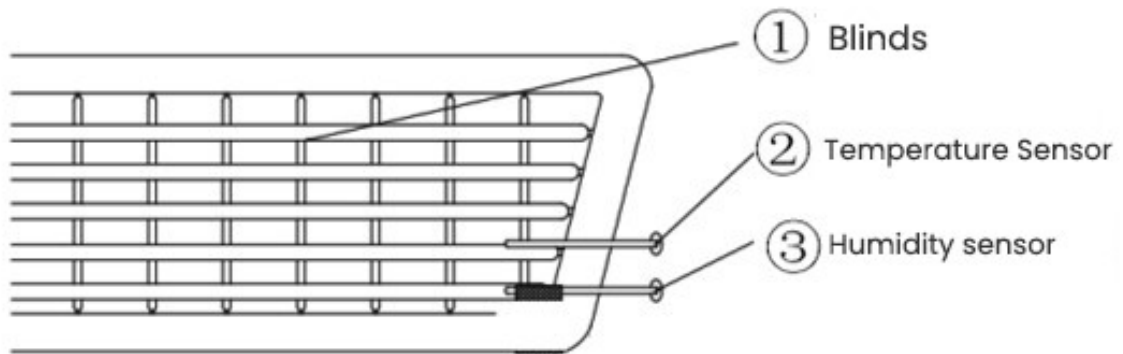

P5 Top component in the inner chamber

No.	Name	Purpose
1	Blinds	Adjust the wind direction. It has been adjusted before leaving the factory. Generally, it should not be adjusted. Adjusting the louvers can change the flow direction of the wind, thereby changing the temperature uniformity of the equipment.
2	Temperature sensor	Test the temperature
3	Humidity sensor	Test the humidity

3.4、Controller



P7 Control Panel

No.	Name	Purpose
1	Control panel	User interface. Used to set temperature and humidity, run or stop test equipment, etc.
2	Power lighting	It always lights up when running.
3	USB port	Use U disk to transfer data and download program interface.
4	Stop button	Press this button, the program will pause.
5	Power switch	Only when this button is turned on will the device control power be turned on and the machine can work normally.
6	Lack of water	When the water level in the water tank of the equipment is low and the humidity cannot operate normally, it will light up to prompt the operator to add water.
7	Start button	Press this button, the program will work.

Chapter 4

Installation

This chapter describes the installation of water and electricity systems in the test chamber, preparation of drainage facilities, equipment site confirmation and installation, etc.

4.1、 Device location

4.1.1 Installation site

The test chamber installation site must meet the following conditions:

- A. Flat and solid site.
- B. Mechanical vibration is small.
- C. Avoid direct sunlight and good ventilation.
- D. The ambient temperature is between $+5\sim+35\text{ }^{\circ}\text{C}$ and there is no drastic temperature change.
- E. No dust, no moisture.
- F. No flammable or explosive materials.
- G. No flammable or corrosive gases.
- H. Air pressure is $86\text{Kpa}\sim 106\text{Kpa}$.
- I. A power distribution cabinet that meets the requirements, equipped with drainage facilities, water supply pipes, etc. (Water-cooled models must also be equipped with cooling water pipes required by the equipment near the machine).

4.1.2 Installation space

A certain amount of space must be left on the left, right, front, back and top of the test chamber for ventilation and maintenance.

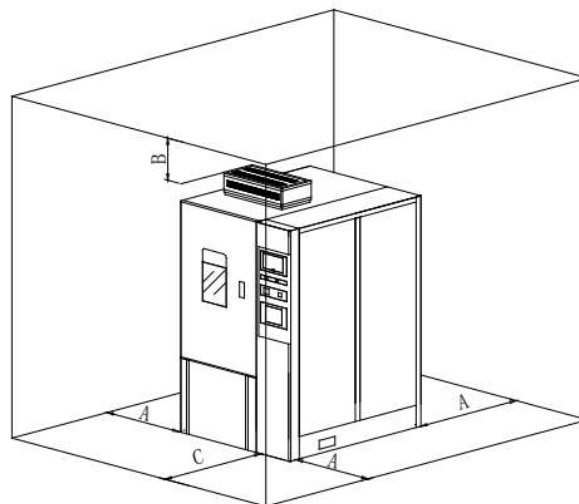

P10 Install controls

In the picture, $A=300\text{mm}$, $B=600\text{mm}$, The size of C is determined according to the door size of the test chamber.

4.2、 How to install

4.2.1 Precautions before installation

- When the equipment arrives at the installation site, first check the outer packaging of the equipment to confirm that there is no damage before unpacking.
- Open the outer packaging of the equipment and check whether the relevant accessories are complete according to the contents on the packing configuration table.
- During transportation, in order to prevent the equipment from being damaged by vibration, some areas are equipped with fixed parts to prevent transportation damage. When disassembling and assembling the equipment, be careful to remove the fasteners.
- When a machine using a semi-hermetic compressor leaves the factory, all the compressor's machine feet are locked with screws to prevent transportation vibration. When unpacking, the compressor's foot screws must be loosened. The spring rises to achieve a shock-absorbing effect when the machine is running. Otherwise, the compressor will make a lot of noise when running, and may damage the piping of the refrigeration system. For German Copeland semi-hermetic compressors, in addition to loosening the base, it is also necessary to remove the U-shaped block outside the fixed screw spring of the base to avoid loud noise and vibration when the compressor is running.
- Please keep the U-shaped block on the compressor properly so that it can be reused during long-distance transportation of the machine.

4.2.2 Fixing and installation of casters

After unpacking, fix the equipment and install it. When positioning, please confirm each size according to the installation space requirements to ensure maintenance space and door opening space.;

When the equipment is installed for the first time, it should be placed on a level ground and the box should be calibrated horizontally. If the box is not kept level during the test run, it may cause operational malfunctions. The casters of the test box are installed at the four corners of the bottom of the test box. The adjustment method is as follows:

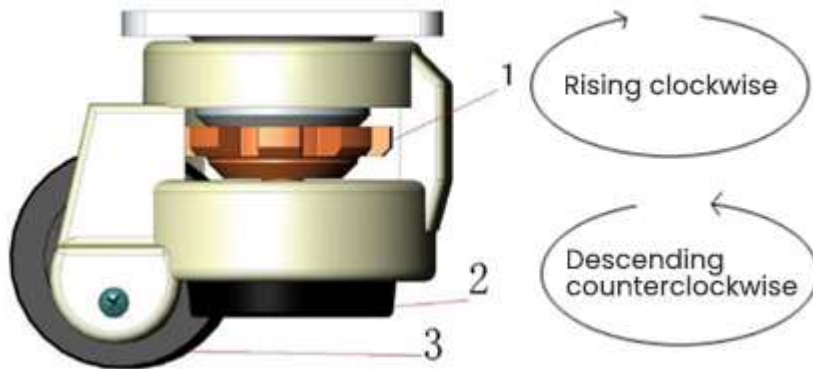

P11 Caster structure

1. Lifting turntable.
2. Fix the base.
3. Wheel.

A、 Move the test chamber: Rotate the lifting turntable clockwise, and the fixed base will move upward. Turn the lifting turntable of each wheel so that the fixed base of each wheel is off the ground, ensuring that all moving rollers are on the ground. At this time, it can be moved easily device to desired location.

B、 Fix the test chamber: After moving the box to the desired position, lower the lifting turntable counterclockwise and raise the moving roller so that the fixed base is in contact with the ground and the box is basically fixed. At this time, use a level to measure whether the box is level. The height of each part of the box can be adjusted through the lifting turntable. The lifting turntable of each part stops rotating after it is adjusted to the appropriate position to ensure that the test chamber is in a horizontal state.

4.3、 Drainage system

The drainage waterway of the equipment is generally located at the rear and lower right side of the box. The specific waterway is introduced in the box structure introduction chapter. The standard equipment comes with an overflow drain pipe. Please connect one end of the drainage pipe directly to the drainage ditch or the corresponding connector or water tray.

The water in the humidification water pan is usually automatically drained and discharged through the overflow pipe drain outlet. The water storage tank is generally

manually drained. When the equipment is not tested for a long time, the water in the equipment should be drained.

4.4、 Power supply

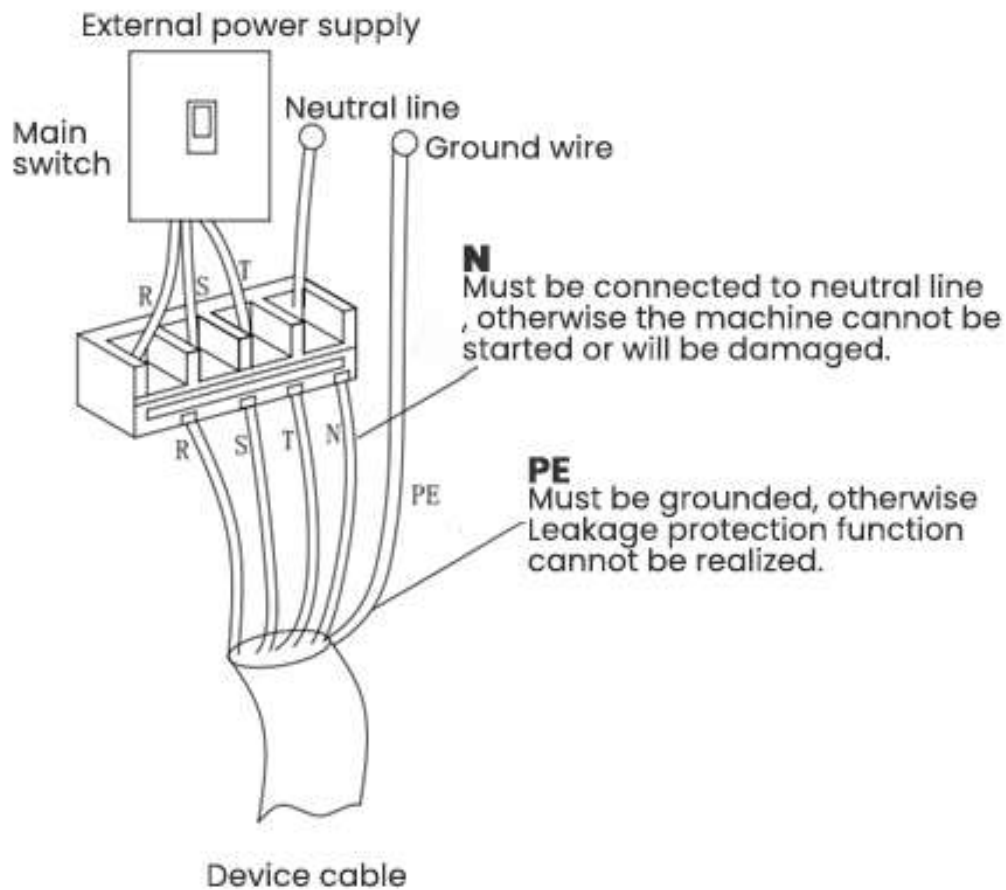

P12 Power supply

4.4.1 Wiring precautions

- When assembling the power supply, it must be operated by a professional electrician.
- Please confirm whether the capacitance of the main switch meets the equipment requirements.
- Please do not use a main switch for other electrical equipment and the power supply of this machine to prevent other equipment from short-circuiting and affect the normal use of the test chamber.
- Since the three-phase current may be unbalanced when the equipment is working, and there may be a relatively large current on the neutral line, the wire diameter of the neutral wire must be close to the wire diameter of the phase wire.
- Please connect the ground wire (yellow-green label) of the test box to the ground terminal reliably so that the leakage switch can cut off the main power supply when the equipment leaks, thus preventing personnel from getting electric shock.
- Do not connect the ground wire to the neutral wire of the power supply.
- Do not share the ground wire of this equipment with other equipment.
- Do not connect the grounding wire to the air pipe or water pipe.

4.4.2 Wiring steps

- Before connecting the machine to the power supply, please confirm whether the wire diameter of the external power supply and the capacity of the main switch meet the requirements of the equipment.
- Please use a multimeter to confirm whether the power supply voltage is normal ($\pm 10\%$ RH deviation allowed), the voltage between the phase lines is 480V, and the voltage between the phase lines and the neutral line is 273V. If there is no problem, turn off the main switch.
- Connect the neutral line (blue N label) of the machine to the neutral terminal in the distribution box (the neutral line must be connected correctly, otherwise the equipment will not work or electrical components will burn).
- Connect the ground wire of the machine to the ground terminal of the distribution

box.

- Connect the three R.S.T. phase wires of the machine to the three terminals at the lower end of the main switch of the distribution box respectively, and make sure the screws are tightened.

NOTE: This machine is designed with a phase sequence protection function. If the phase sequence is connected incorrectly, the instrument will not be energized when it is turned on. You need to change the three phase wires at the lower end of the main switch of the distribution box by randomly changing the positions of the two wires. The phase sequence meets the requirements of the test chamber.

Chapter 5

Test Preparation

This chapter describes some preparations that should be done before conducting tests on the climate chamber, including over-temperature protection settings, sample placement, sample connection methods and other preparations. Ensure the accuracy and standardization of the test.

5.1、 Water level

Check the water level of the humidification water tank. Especially before getting off work on weekends, be sure to check whether there is enough water in the water tank to prevent water shortage when the test is halfway through, causing the test to be interrupted and causing unnecessary trouble; the water level in the water tank should not exceed The highest water level mark, otherwise it will cause overflow and may leak to the bottom of the machine.

5.2、 How to place the specimen

Place the test sample in the test chamber at a certain distance from the inner wall to ensure air circulation around the sample.

If the air circulation is blocked, the uniformity of the test chamber will be reduced, the test error will increase, or the test effect will not be achieved. Generally, the total volume cannot exceed 1/3 of the total volume of the inner chamber.

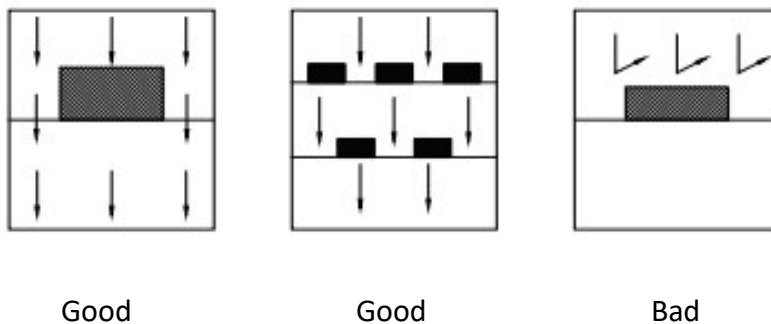

P16 How to place the sample

When the air flow is smooth, the position of the sample rack can be adjusted according to the size of the sample. The placement steps are:

(1) Depending on the size of the sample, adjust the sample holder fixture to the appropriate position as shown in the figure below.

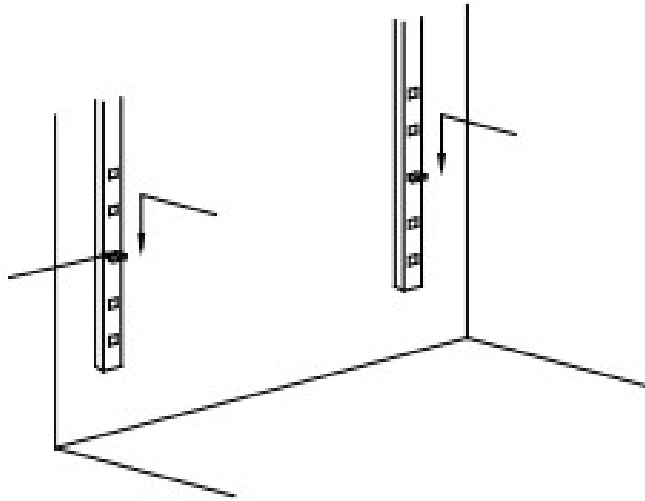

P17 How to Install the Sample Holder Fixture

(2) Place the sample holder on the sample holder fixture and push it into the test chamber in the horizontal direction.

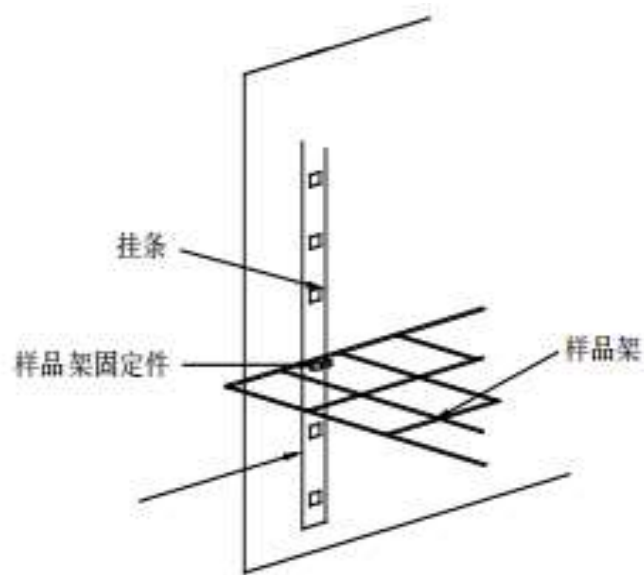

P18 How to install the sample holder

5.3 How to use rubber stopper:

After the sample cable passes through the cable hole, use a rubber plug to block the cable hole. If it is not blocked, the outside air will penetrate into the test area, which will affect the temperature or humidity control. Make a notch in the stopper, the same size as the sample cable, and install the cable in the notch.

The sample cable must be a cable that can withstand the test conditions.

The following table shows various types of cables and their withstand temperatures.

P10 Different types of cables withstand temperature ranges

Cable type	withstand temperature
vinyl cable	55°C
Heat-resistant vinyl cable	100°C
Styrene-butadiene insulated flexible wire cable	70°C
Glass flat ribbon silicon shielded cable	200°C

When the cable hole is not in use, pls install the rubber plug inside and the cover on the outside.

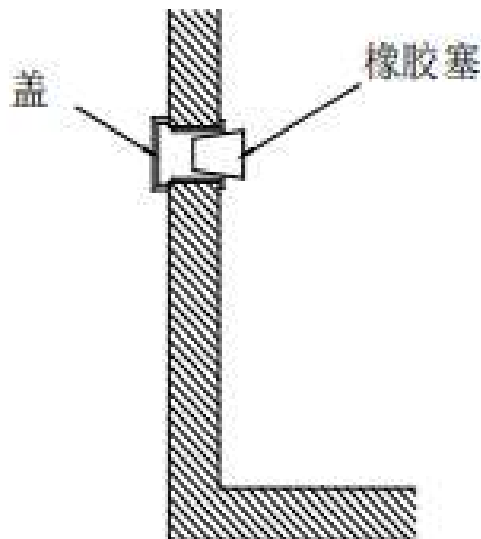

Chapter 6 Control System (see attachment)

This chapter describes the functions of each button on the program interface after the instrument in the climate chamber is turned on and the specific program operation methods after it is turned on, so that customers can understand the program operation process during the test. Routine maintenance of equipment

Chapter 7

Routine maintenance

This chapter describes the daily care methods for the water storage tank, humidification water tray, test area and other parts of the climate chamber. Routine maintenance can effectively improve the accuracy of the test and the service life of the equipment.

7.1、Cleaning of water storage tanks

If the water in the water storage tank remains for a month or more, continued use will shorten the service life of the humidifier and humidity sensor due to water corrosion, so the water storage tank needs to be cleaned once a month.

7.2、Cleaning the humidification water tray

During the operation of the equipment, dirt and foreign matter will adhere to the humidification water pan and humidifier. To ensure the service life, it is necessary to clean the humidification water pan and humidifier once a month. If the equipment is not used for a long time, a good way to prevent dirt from gathering is to set 60°C after each test (without setting the humidity). After running the machine, the machine will automatically drain the water from the humidification water pan.

Humidification water tray cleaning steps:

- (1) Open the test chamber door.
- (2) Use a screwdriver to open the return air net and take out the return air net.
- (3) Use a brush or other methods to clean the surface of the humidification water tray and humidifier (note that acidic or alkaline substances cannot be used to scrub the humidifier, otherwise corrosion may occur).
- (4) Dry the humidification water tray and humidification tube with a towel.
- (5) After installing the return air net, close the door of test chamber.

7.3、Cleaning of the inner chamber

Dirt and foreign matter in the inner chamber may affect the test results, so it is necessary to clean the test area before each test.

Inner chamber cleaning steps:

- (1) Open the door.

(2) Use a soft cloth to clean the inner chamber, hanging strips and other parts.

(3) Close the door.

7.4、 Detection of leakage protector

To ensure the normal operation of the circuit breaker and leakage protection switch, please check this part regularly (once a month is recommended).

Inspection method: While pushing up the circuit breaker, click the test button. If the circuit breaker trips, the protection action is normal; otherwise, it is abnormal. Please check it as soon as possible or contact our after-sales service department.

7.5、 Cleaning of distribution cabinets and water circuit rooms

Dust accumulation in distribution cabinets and water circuit rooms can cause unnecessary failures. Therefore, it is necessary to clean the distribution cabinet and water circuit regularly.

Cleaning steps for distribution cabinets and water circuit rooms:

(1) Turn off the main power switch (leakage circuit breaker);

(2) Open the covers of the power distribution cabinet and water circuit room;

(3) Use a vacuum cleaner or compressed air spray gun (must be dry and clean compressed air) to remove dust from the distribution cabinet and water circuit room. Follow the cleaning sequence from top to bottom to prevent repeated cleaning; be careful DO not pull the wires too hard when cleaning, water pipes to prevent inadvertent changes in the condition of lines or pipelines, causing unnecessary trouble;

(4) Check whether the water pipe is loose, and if so, tighten it;

(5) Install the covers of the distribution cabinet and water circuit room.

7.6、 Observation of pressure gauge

To ensure the normal operation of the refrigeration system, please check the refrigerant pressure gauge on the rear side of the box regularly. Generally, we read the reading of the innermost ring (unit PSI). Under normal circumstances, the static pressure of the pressure gauge should be between 50 and 150Psi.

The outer ring of the pressure gauge usually has a pressure mark made at the factory, which indicates the static pressure when the compressor is stopped. In the shutdown state, the pointer should point to this mark, but as the seasons change, the pointer may fluctuate (lower in winter, higher in summer).

If you observe that the pointer of the pressure gauge is significantly lower than this mark and the temperature does not drop, it can be inferred that the refrigerant is leaking. Please contact our after-sales service department in time.

7.7、 Routine maintenance of long-term idle equipment

Before the equipment is not used for a long time, please follow the steps below to extend the life of the equipment and reduce the maintenance rate.

1. Drain the humidification water pan and water return pipe.

Drainage method:

Set the controller to a temperature, such as 65°C (do not set humidity). After running the machine, the drainage pump will start and automatically drain the water in the humidification water pan;

2. Drying test area (operation test chamber).

Drying method:

Open the test hole of the equipment and set a temperature on the controller, such as 85°C (do not set humidity). After running the machine, the remaining moisture in the box will run out of the test hole at high temperature and drying the test chamber.

A、 Run the climate chamber to dry the test area.

B、 Turn off the humidity control and run the test chamber at or above 87°C for 60 minutes. Note: If necessary, drain the water in the humidification water pan.

3. Turn off the main power switch (leakage circuit breaker) and cut off the power supply.

Steps to turn off the main power switch:

A. Turn on the main power switch (leakage circuit breaker).

B. If the door of the chamber makes a slight popping sound and the test is in progress, it is necessary to change the settings in order not to interrupt the operation or cause an alarm.

C. Turn off the humidity control and set the final temperature to 87°C.

D. Select the operating mode.

E. Then, press the "Run" button in the setting mode, and press the "Execute" button in the subsequent confirmation message box. Close the door and let the device run for 60 minutes.

F. Return to step C to change the device settings to the initial state.

G. Turn off the main power supply (leakage circuit breaker), and then cut off the power supply.

Electrical symbol table

Electrical symbols	Corresponding vitality parts	Electrical symbols	Corresponding vitality parts
QF	Main switch	OH	over temperature protector
KM	Contactora	HPS	Refrigeration system high pressure alarm
KA	Relay	LPS	Refrigeration system low pressure alarm
FS	Water level switch	PPR	Under reverse phase protector
EH	Heating tube	FR	Thermal relay
T	Transformer	KT	Timer
FQ	Breaker	PM	Electromagnetic water pump
HA	Buzzer	SSR	Solid state relay
TC	Temperature Controller	DH	Defrost line
SV	Refrigeration solenoid valve	FU	Fuse

NOTE: The number after the electrical symbol in the circuit diagram represents the number of such components used in the equipment. For example: "3" in KM3 represents the third contactora used in the equipment. The component number on the switchboard is the same as the electrical component number. The symbols on the schematic diagram are in one-to-one correspondence.

PACKING LIST

NAME	PCS	NOTE
Climate Chamber	1	
User Manual	1	
Certificate	1	
Warranty Card	1	
Nameplate	1	
Rubber stopper	1	Φ 50mm (standard)
Hook up	8	
Sample rack	2	

TH series
Temp. and Humi.
Controller

Operational manual
(V20S)

Thank you for your choice of our programmable controller (TH Series). This manual describes the method of operation of product

Cautions in this instruction manual

1. Please deliver for the end user to possess always and keep it in the accessible place at any time.
2. Use the product after full understanding of this operation manual.
3. This operation manual does not warrant any other things because it is a description of the details for the function.
4. A part or whole of this manual shall not be edited or copied randomly.
5. The descriptions in the manual may be changed randomly without pre-notice or warning.
6. Even though this manual was made with elaboration, it will be appreciated if you inform to the purchasing point (Dealer shop and etc.) or sales lean in our company in case of deficiency, mistake or omission in the contents.
Cautions for the safety and modification (Change) of the product

7. Please use this product after full understanding on the safety cautions in this manual for the protection and safety for this product and the system connected to this system.

8. Our company is not responsible to the damages occurred by using or handling or unattended using not relying on this operation manual.
9. Please install at the outside of this product when the additional protection and safety circuit is installed separately for the protection and safety for this product and the system connected to this system.
10. The internal modification (Change) and addition to this product are prohibited.
11. Do not disassemble, repair and modify of this product because it becomes the reasons for electric shock, fire and malfunction.
12. Please contact our sales department of our company, incase of changing the part or the consumables of this product.
13. Do not contact to the moisture with this product. It may cause the failure on this product.
14. Do not apply the strong impact on this product. It may cause the damage and failure on the product.

With regard to the exemption for responsibility of this product

We are not responsible for the direct or indirect damages on the user of any third party to the not expectable defects or the natural disaster in use of this product.

With regard to the quality assurance condition of this product

The warranty period shall be one year from the purchasing of this product. Free of charge repair is available only for the cases of out order occurred from normal use conditions.

The repair due to the out of order occurred after the warranty period shall be repaired at the actual cost according to the defined condition by our company.

For the following events, faults occurring within the warranty period must be repaired at the actual cost in spite of the warranty period.

- (1) Out of order due to the mistake or fault of the user (Ex: Initialization by losing the password and etc.)
- (2) Out of order due to natural disaster (Ex: Fire and flood and etc.)
- (3) Out of order due to the movement of product after installation.
- (4) Out of order due to the random disassemble, change or damage on the product.
- (5) Out of order due to the electric power instability.

If it is necessary to repair the product due to a malfunction, etc. please contact the place of purchase or our sales department.

01. Operation and set

This product is a multi-channel programmable controller designed as user friendly to touch screen interactive screen

1-1. Basic operation flow chart

The logo screen and the initial screen are displayed sequentially when the electric power is switched "ON" after installation of the product and it converts to the Program stationary screen. It takes about 20 seconds for screen loading.



Main Screen



FIX operation stop screen 1



Program stop screen 1



FIX operation run screen 2



Program run screen 2

1-2. Setting button operation

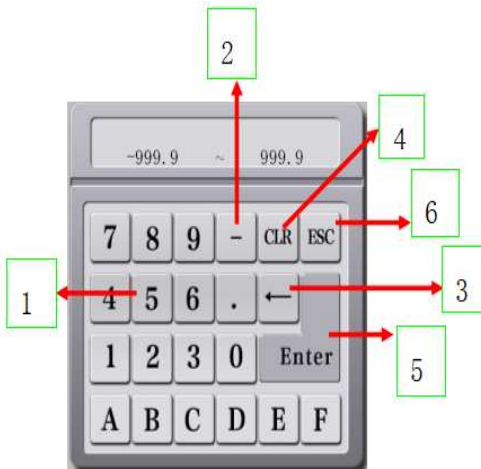

Button type	Button operation
1	Numeric input area
2	Enter a minus sign; when you want to enter a negative number, press this key first.
3	It is used for erasing the input data by one character
4	It is used for erasing all input values
5	It returns to the original screen after saving the input values
6	It for returning back to original screen after stopping the input

1-3. Parameter set method

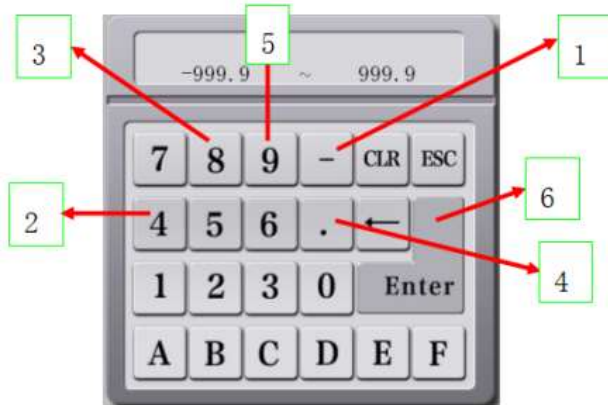

For example: The steps to change the value of 50.0 to -48.9
 Steps as follows: 1-2-3-4-5-6

02.Main screen



[Fig.2-1] Main screen

No.	instructions	Descriptions
1	OPER.SCREEN	Enter OPER.SCREEN
2	FIX.SET	Enter FIX.SET
3	PROGRAM SET	Enter PROGRAM SET
4	GRAPH &REC.	Enter GRAPH &REC.
5	FUNCTION SET	Enter FUNCTION SET
6	RESERVER SET	Enter RESERVER SET
7	FILE	Enter FILE
8	ALARM SCREEN	Enter ALARM SCREEN

OPER.SCREEN setting



Main screen



[Fig.3-1] Fix operation stop screen 1



[Fig.3-2] Fix operation run screen 1



[Fig.3-3] Fix operation run screen 2

03.OPER.SCREEN set

3-1 Fix operation

When the operation state screen is selected in [Fig.2-1] Main screen, it is converted to [Fig.3-1]

Fixed operation stop screen 1(Asynchronous operation)

When **START** at the right bottom of [Fig.3-1] Fixed operation stop screen 1 (Synchronous operation) is touched by. it converts to [Fig.3- Fixed operation run screen 1 Synchronous operate.



[Fig.3-1] Fix operation stop screen 1



[Fig.3-1] Fix operation stop screen 2

No.	instructions	Descriptions
1	CONT	Run time accumulation - Continue to run cumulatively
2	YES	Run time zeroing - Re-timed the run
3	PV HIGH	When the actual temperature value exceeds the PV alarm setpoint, the machine alarm stops to protect the product and the box
4	TEMP SP	It displays set value (sp) to control temperature(temp)
5	HUMI SP	It displays set value (sp) to control humidity(humi.)

		Lighting switch - time setting 30S, automatically turn off
6	LIGHT	after the time is up, when setting 0S, you need to manually turn off
7	ENERGY SAVING	Click here, HMI goes into battery saver mode
8	START	Start the machine

3-1 Fix operation run screen 1

It is a screen to display the state display lamps such as setting value and present value and etc.

When the "Setting value" is touched even if during the operation, input key for setting targeted value to operate is activated

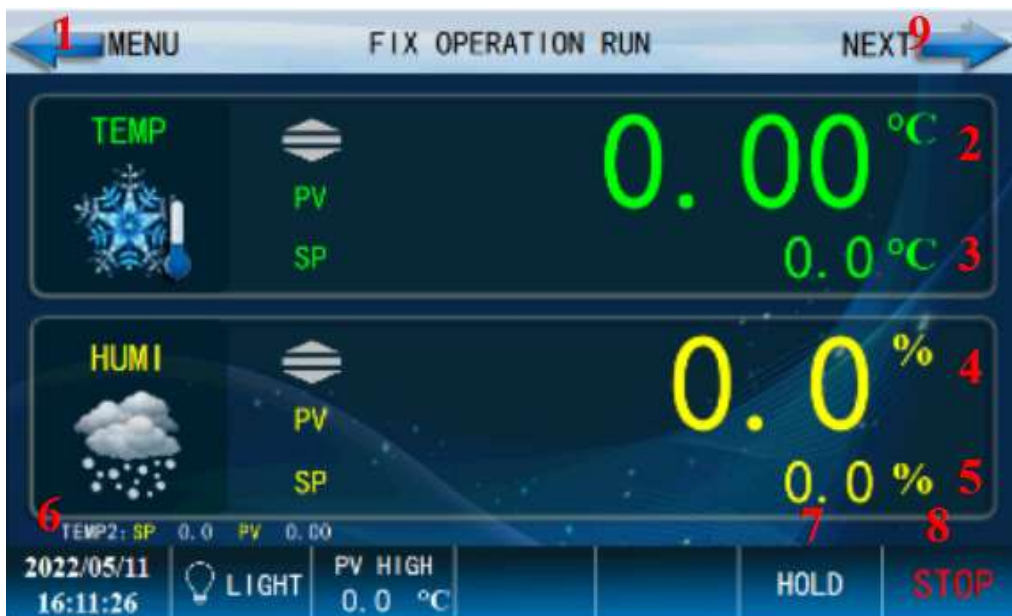

[Fig.3-2] Fix operation run screen 1

No. instructions Descriptions

1	MENU	Move to [Fig.2-1] Main screen
2	TEMP PV	It displays the present value (PV) of temperature
3	TEMP SP	It displays the temperature setting data (SP) to be controlled
4	HUMI PV	It displays the present value (PV) of humidity
5	HUMI SP	It displays the humidity setting data (SP) to be controlled.
6	TEMP2	It displays the present value (PV) and setting data (SP) of wet-bulb
7	HOLD	Select Hold and the run timing time remains the same
8	STOP	Stop button
9	NEXT	Move from current screen to next screen



References

- ▶ Setting data > Measuring data is displayed in TEMP and HUM increase.
- ▶ Setting data = Measuring data is displayed in TEMP maintaining.
- ▶ Setting data < Measuring data is displayed in TEMP decrease.



3-1 Fix operation run screen 2

It is a screen to display the state display lamps such as measuring value, setting value and output volume etc.



[Fig.3-3] Fix operation run screen 1

No. Descriptions

1 MENU: Move to [Fig.2-1] Main screen

2 It displays the control output volume (MV) in temperature.

3 It displays the control output volume (MV) in humidity.

4 Currently running PID, It displays the currently applied PID group number.

5 It displays the fixed value has been run for time

6 It displays the total process time of stationary operation

7 State display lamps. The details are shown in the following figure

8 Stop button

9 Move from current screen to next screen

References

▶ Click on the indicative light area, and the screen will pop up to indicate the detailed picture of the lamp. The right side shows the operating status of the entire machine

IS1	IS2	IS3	IS4	IS5	IS6	IS7	IS8	IS9	IS10	IS11	IS12	IS13	IS14	IS15	IS16	TS1	TS2	TRUN	TUP	TSK	TDN	TW	
T1	T2	T3	T4	T5	T6	T7	T8	AL1	AL2	AL3	AL4	AL5	AL6	AL7	AL8	Drain	CL1	CL2	HRUN	HUP	HSK	HDN	HW

← BACK																				2022/05/12 15:40:40	
IS1	IS2	IS3	IS4	IS5	IS6	IS7	IS8	IS9	IS10	IS11	IS12	IS13	IS14	IS15	IS16	T-S	H-S				
T1	T2	T3	T4	T5	T6	T7	T8	TS1	TS2	TS3	TRUN	TUP	TSK	TDN	TW	S1	S2				
AL1	AL2	AL3	AL4	AL5	AL6	AL7	AL8	Drain	CL1	CL2	HRUN	HUP	HSK	HDN	HW	S3	S4				
Y0	Y1	Y2	Y3	Y4	Y5	Y6	Y7	Y10	Y11	Y12	Y13	Y14	Y15	Y16	Y17	TEMP SLOPE					
Y20	Y21	Y22	Y23	Y24	Y25	Y26	Y27	Y30	Y31	Y32	Y33	Y34	Y35	Y36	Y37	0.00 °C/min					
Y40	Y41	Y42	Y43	Y44	Y45	Y46	Y47	Y50	Y51	Y52	Y53	Y54	Y55	Y56	Y57						
Y60	Y61	Y62	Y63	Y64	Y65	Y66	Y67	Y70	Y71	Y72	Y73	Y74	Y75	Y76	Y77						
X0	X1	X2	X3	X4	X5	X6	X7	X10	X11	X12	X13	X14	X15	X16	X17						
1#	2#	3#	4#	5#	6#	7#	8#	9#	10#	11#	12#	13#	14#	15#	16#	17#	18#	19#	20#		

[Fig.3-4] State display lamps detail

3-2 Program operation

(1) Program operation stop screen 1

It converts to “Program operation stop screen 1” when the operation state screen is selected in [Fig.2-1 Main screen Select the “FUNCTION SET” with “PROG” in [Operation mode]].



[Fig.3-5] PROGRAM stop screen 1



[Fig.3-5] PROGRAM stop screen 2

No.	instructions	Descriptions
1	CONT	Run time accumulation - Continue to run cumulatively
2	YES	Run time zeroing - Re-timed the run
3	PV HIGH	When the actual temperature value exceeds the PV alarm setpoint, the machine alarm stops to protect the product and the box

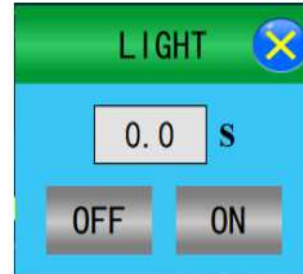

[Fig.3-5] PROGRAM stop screen 1

No. instructions Descriptions

4	PTN NO.	Set the number of program groups that need to be run (setting rang1-100)
5	NAME	It displays the name title corresponding to the current program
6	LIGHT	Lighting switch - time setting 30S, automatically turn off after the time is up, when setting 0S, you need to manually turn off
7	ENERGY SAVING	Click here, HMI goes into battery saver mode
8	START	Start the machine

3-2 Program operation stop run screen 1

The PROG number cannot be set during operation. It is a screen for Measured data and Set data.



[Fig.3-6] PROGRAM run screen 1

No.	instructions	Descriptions
1	MENU	Move to [Fig.2-1] Main screen
2	TEMP PV	It displays the present value (PV) of temperature
3	TEMP SP	It displays the temperature setting data (SP) to be controlled
4	HUMI PV	It displays the present value (PV) of humidity
5	HUMI SP	It displays the humidity setting data (SP) to be controlled.
6	TEMP2	It displays the present value (PV) and setting data (SP) of wet-bulb
7	HOLD	Select Hold and the run timing time remains the same
8	STOP	Stop button
9	NEXT	Move from current screen to next screen
10	STEP	Terminating the currently processing segment and forced moving to the next segment.
11	PTN NO.	Currently processing program number
12	SEG NO.	Currently processing segment number
13	PRO TIME	The program has run for time

3-2 Program operation stop run screen 2



[Fig3-7] PROGRAM run screen 2

No. Descriptions

1	MENU: Move to [Fig.2-1] Main screen
2	It displays the control output volume (MV) in temperature.
3	It displays the control output volume (MV) in humidity.
4	It displays the currently operated program number
5	It displays the pattern repetition state. The figure in the front in [0/0], the frequency of repetition and the figure at the end shows the set repetition frequency.
6	It displays the currently operated segment number.
7	State display lamps. The details are shown in the following figure
8	Stop button
9	Move from current screen to next screen
10	Currently running PID It displays the currently applied PID group number.
11	It displays the partial repetition state. The figure in the front of SEG.NO: 00/00, the frequency of repetition and the figure at the end shows the set
12	It shows the segment processing time
13	It shows the segment the time at the end
14	Terminating the currently processing segment and forced moving to the next segment.
15	Maintaining (Hold On) or Release (Hold Off) the currently operating temperature and humidity set value.

04.FUNCTION SET

It is a screen for general additional functions and additional setting in stationary operation

4-1 OPER MODE

It converts to the "FUNCTION SET" when the operation motion setting is selected in [Fig. 2-1 Main screen]

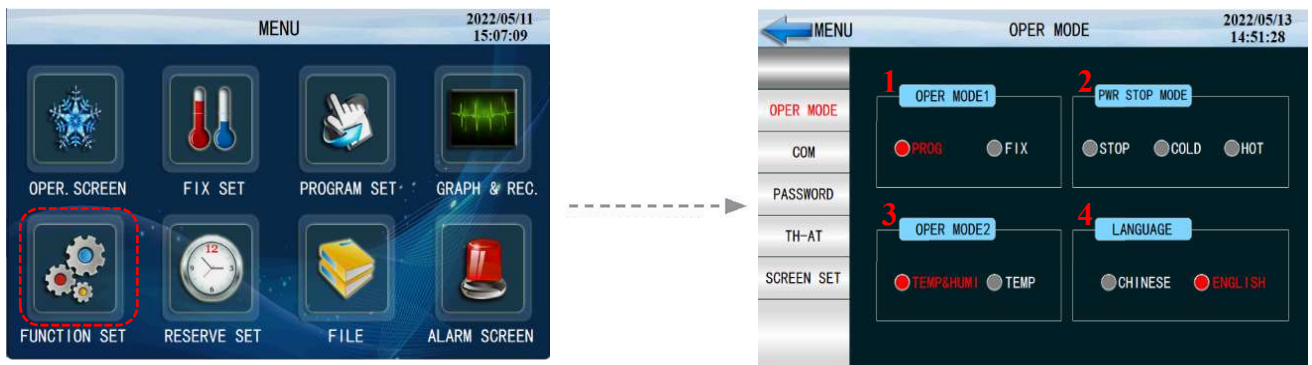

[Fig.4-1] OPER MODE

No. Descriptions

1	Setting with selection either of pattern or stationary operation for operation mode. (It cannot be changed during operation.) PROG: Setting in program operation FIX: Setting in stationary operation STOP: A motion to return to the operation stop state after power on from the black out.
2	COLD: An operation from the beginning after power on from the black out. HOT: A motion to return to the previous operation state after power on from the black out.
3	Temperature control Temperature and humidity control (It cannot be changed during operation.)
4	Languages (Chinese / English)

4-2 COMMUNICATION



[Fig.4-2] COM screen

No.	instructions	Descriptions
1	Com MODE 1	H02: Set plc to slave
2	Com MODE 2	It displays the Baud rate setting. H 81: The default baud rate is set to 9600, 8, 1, N.
3	ADDRESS	It displays the Slave address setting. H01: The default slave station number is 1, and the maximum is 31
4	TIMEOUT	200: Timeout is set to 200ms by default

In the PLC program, the above several registers are configured, when the corresponding communication port has a communication frame sent by the MODBUS master to the local address, the PLC system program will automatically organize the MODBUS communication frame to reply according to the communication requirements, without the participation of the user program.

4-3 PASSWORD

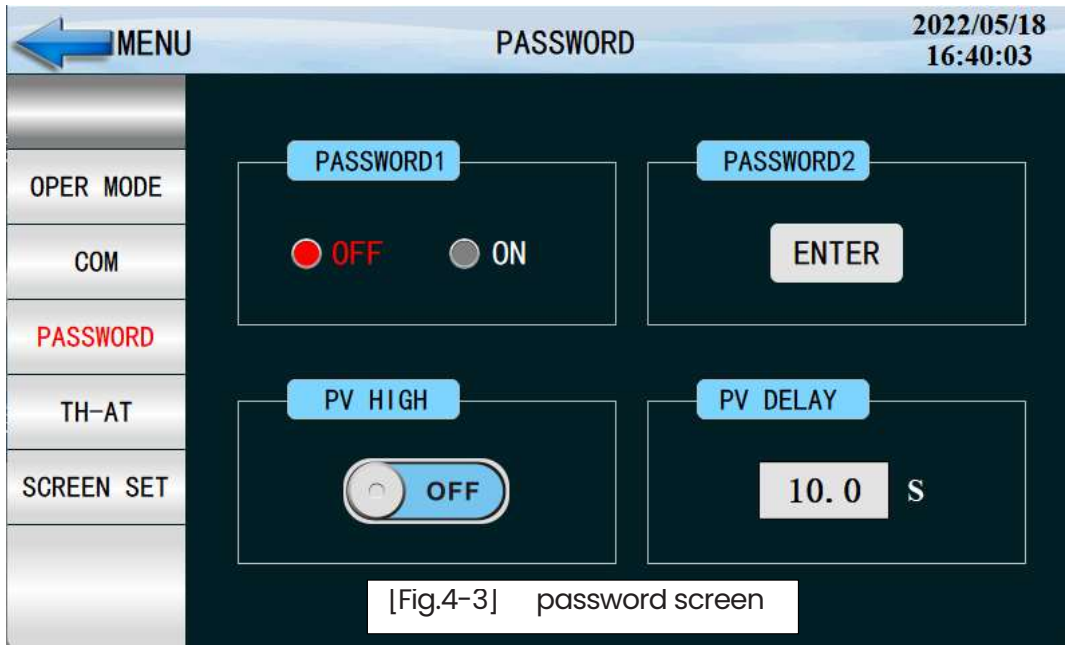

No.	instructions	Descriptions
1	PASSWORD1	Select "PASSWORD1", enter the password 456, and enable and disable the input permission function
2	PASSWORD2	Modify the password of each level of authority
3	PV HIGH	Set whether to stop the device after PV alarm
4	PV DELAY	Delay start PV alarm function

When the "PASSWORD" is turned ON, the program parameters or fixed temperature and humidity settings cannot be modified, and the on-site operator cannot control the start and stop of the equipment.

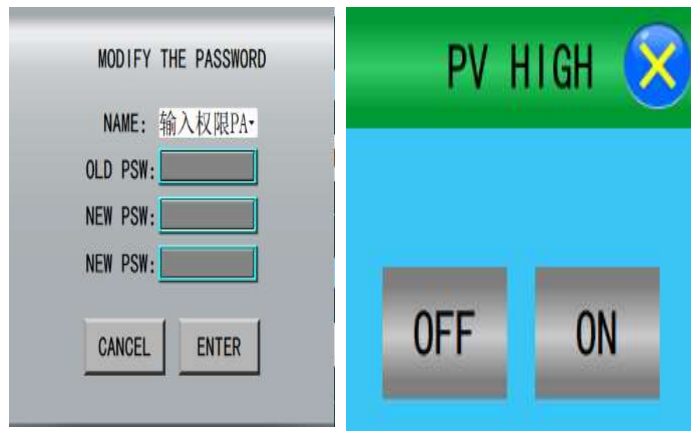

4-4 TH-AT

Click to set on, then go to the "OPER.SCREEN" and click the temperature or humidity auto-tuning to start.

Auto-tuning is a function that the controller measures, calculates the characteristics of the controlled object, and automatically sets the most suitable PID parameters



[Fig4-4] TH-AT

The segment is held during program operation and the segment is processed when the auto tuning is terminated.

Auto tuning is a function to set the optimal PID integer automatically by measuring and calculating the object of control with controller. The controller generates the ON/OFF control output during "2.5 periods" during auto tuning and it calculates the PD data automatically based on the period and oscillation magnitude using the limit cycle to the object to be controlled. The Auto-Tuning is available in program stationary operation.

The PID data calculated from the set value located PID group is saved automatically through Auto-Tuning from the currently set value.

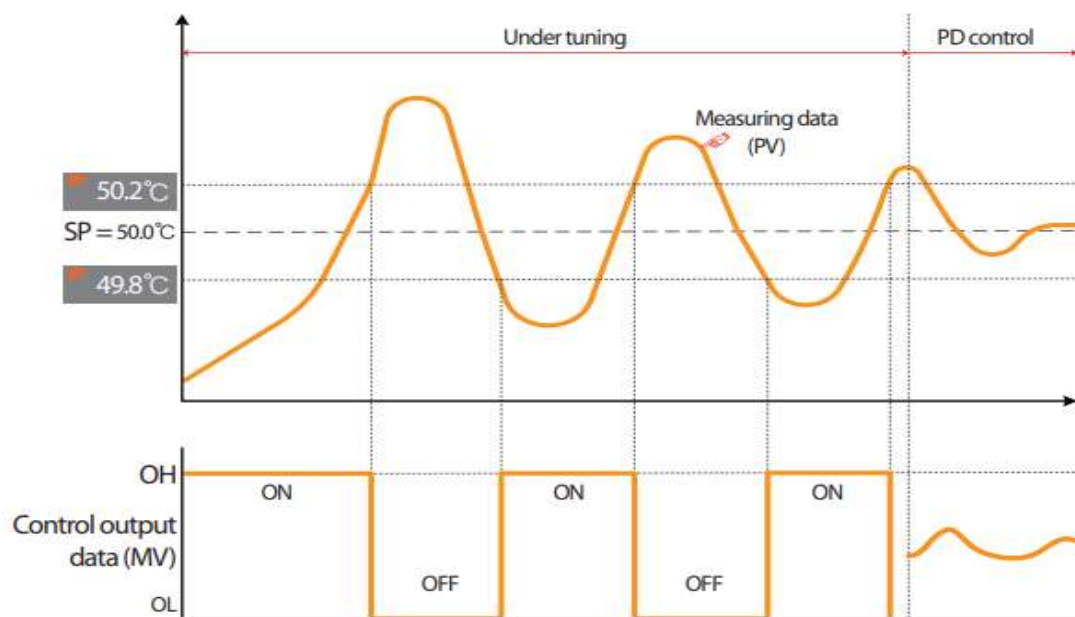

[Fig.4-5] Auto tuning operation

Cautions in Operation: 

Any change in set value (SP) in auto tuning does not change the turning point. And the tuning is started with changed set value (SP) for target set value (TSP) after auto tuning termination.

The auto tuning is stopped in case of "Sensor short" in input during auto tuning. At this time the PID data is kept with the previous set value.

When auto tuning is processed beyond 27 hours, the auto tuning is stopped.

The PID set value can be changed during auto tuning, but the obtained PID data from calculating in auto tuning termination is reset with the obtained PID data. The PID set value is maintained with previous set value when the auto tuning is forcibly terminated.

For better Auto-Tuning results, need to wait until stabilization by set value (temperature), then Autotuning the temperature first.

And after Autotuning the humidity, will get better P,I and D value (data).

References

▶ An example of auto tuning depending on the set value.

- Operation method : Stationary operation /

- Temperature auto tuning point : 0.10% → EUS 0.10% = 0.2°C

- Output lower limit (OL) : 0.0% / Output upper limit (OH) :

Sensor input : Temperature (PT_1) - Set value (SP) : 50.0°C

- Range : -50.00°C ~ 150.00°C

100.0%   : Auto tuning point

4-5 Screen set

It is a screen for some accessibility features on HMI.



[Fig4-6] Screen set

No.	instructions	Descriptions
1	PWR TIME	The accumulated time the equipment has been powered on
2	PTEND	Function switch: output a relay point after the program ends
3	BLACKLIGHT	It sets the backlight electricity saving time. The electricity saving time sets the operation timing of backlight OFF when there is not key operation.
4	BRIGHTNESS	Screen brightness setting (0-100%)

05.RESERVE SET

It converts to [Fig. 5-1 Reserve set] when the appointed operation setting button is touched by in [Fig. 2-1 Main screen] It is a screen to set the current time and appointed operation time.



No.	instructions	Descriptions
1	CURRENT TIME	It sets the year, month, day and hour. The current time is not changeable during recording the measured data and operating.
2	RESERVE TIME	It sets the year, month, day and hour for appointed operation.
3	RESERVE	The operation is possible in the set appointed time when RESERVE is touched by.
4	MODE	Screen brightness setting (0-100%)

Parameter	Setting range	Unit	Initial value	
Current time	Year	0000-9999	ABS	
	Month	1-12	ABS	
	Day	1-31	ABS	
	AM/PM	AM,PM	ABS	
	Hour	0-23	ABS	
	MIN	0-59	ABS	
Reserve time	Year	0000-9999	ABS	2022
	Month	1-12	ABS	5
	Day	1-31	ABS	20
	AM/PM	AM,PM	ABS	AM
	Hour	0-23	ABS	12
	MIN	0-59	ABS	0
Reserve	Click for appointment			

7.Alarm screen

It converts to [Fig. 7-1 Time setting screen] when the Alarm screen setting button is touched by in [Fig. 2-1 Main screen]. It is a screen to display the type, date and time of error created DI



[Fig.7-1] Alarm list



[Fig.7-3] OPE History



[Fig.7-2] Alarm History

7-1 Alarm List

← MENU		ALARM LIST		2022/05/19 15:45:53	
	NO.	ALARM NAME	NO.	ALARM NAME	
ALA LIST	0		10		
	1		11		
ALA HISTORY	2		12		
	3		13		
OPE HISTORY	4		14		
	5		15		
	6		16		
	7		17		
	AL1		AL5		
	AL2		AL6		
CANCEL	AL3		AL7		
	AL4		AL8		

[Fig.7-1] Alarm list

No. Descriptions

- | | |
|----------|--|
| 1 | 0~7,10~17: It displays the DI error in progress |
| 2 | AL1~8: It displays the ALM error in progress |
| 3 | Alarm Name: Label each group of alarm contents, such as water shortage, overload, over temperature, etc. |
| 4 | CANCEL: Manually cancel the alarm (can be canceled only after the cause of the alarm is cleared) |

7-2 Alarm History



No. Descriptions

- 1** It displays the history of error creation
- 2** Export alarm data to U disk
- 3** Historical alarm query time setting
- 4** History alarm refresh
- 5** It deletes the entire Historical alarm creation.

[Fig.7-2] Alarm History

7-3 OPE History



[Fig.7-3] OPE History

No. Descriptions

- 1** It displays the history of operation creation
- 2** Export Historical Operational Data to U disk
- 3** Historical Operational Data query time setting
- 4** History Historical Operational Data refresh
- 5** It deletes the entire Historical Operational Data creation.

08.GRAPH&REC

It converts to [Fig. 8-1 GRAPH VIEW] when the Alarm screen setting button is touched by in [Fig. 2-1 Main screen]. It is a screen to display the data recorded in Stationary operation [Fig.3-2] Fix operation run screen 1] and Program operation [Fig.3-6 PROGRAM run screen 1]. The date and time saved into the memory.

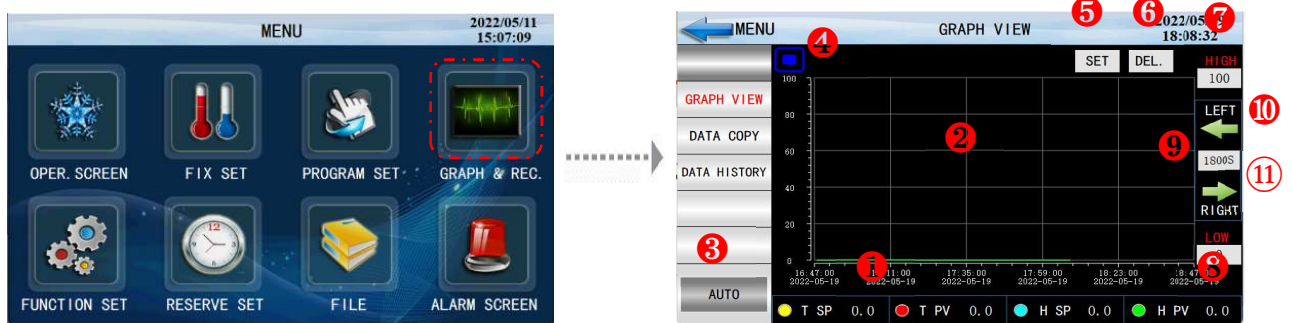







[Fig.8-1] GRAPH VIEW Screen

No. Descriptions

	It displays the temperature (Set-data, Indicated-Data) and humidity (Set-data Indicated-Data).
1	<p>▷When the <input checked="" type="checkbox"/> checked bis touched, it is disappeared on the graph screen and</p> <p>▷When <input type="checkbox"/> is touched, it is displayed on the graph screen.</p>
2	Data
3	AUTO: (recording after power-on), Manual:(recording after the machine is running)
4	Refer to the reference
5	Set query start time point and span time period
6	It deletes the entire graph view (Permission is operator, password 666666)
7	Upper limit: set the upper limit of the Y axis (the upper limit of the temperature and humidity display)
8	Lower limit: set the lower limit of the Y axis (the lower limit of the temperature and humidity display)
9	Set the time span of each X-axis move to the left or right.
10	When touch here move to the left by the time span set by 9
11	When touch here move to the right by the time span set by 9



-  Graph query button, set start time point and span time period
-  Display to update the graph screen immediately which is being saved.
-  When touch here move to the left by the time span set by 9
-  When touch here move to the right by the time span set by 9
-  Cursor bar display keys
-  The time axis is expanded
-  The time axis is reduced

8-1 Data Copy

It is a screen for Data copy parameter setting.

The screenshot shows the 'DATA COPY' screen with the following elements:

- Top Bar:** 'MENU' (with a left arrow), 'DATA COPY', and the date/time '2022/05/20 11:36:52'.
- Left Menu:** 'GRAPH VIEW', 'DATA COPY' (highlighted in red), 'DATA HISTOR' (with a red 5), and a red 6.
- Main Content Area:**
 - NO.:** 1 (marked with red 1)
 - NAME:** abc (marked with red 2)
 - RECORDING CYCLE:** 60 S (marked with red 3)
 - DATA COPY:** A red button (marked with red 4)
 - START TIME:** A table with columns Y, M, D, H, MIN, S. Values: 2022, 5, 20, 11, 36, 0 (marked with red 5).
 - END TIME:** A table with columns Y, M, D, H, MIN, S. Values: 2022, 5, 20, 11, 36, 0 (marked with red 6).
 - Copy Status:**
 - 1: SUCCESS (marked with red 7)
 - 100: NO DISK
 - 102: NO. ERR
 - 103: FAIL
 - VIEW:** A button with '0' (marked with red 8)

[Fig.8-2] DATA COPY Screen

No. Descriptions

- | | |
|---|---|
| 1 | It can only be set to 1 |
| 2 | Name the exported file |
| 3 | The time interval between recording a data |
| 4 | Copy the recorded data files into the internal memory to u-disk |
| 5 | Set the start time period of the data you want to copy |
| 6 | Set the end time period of the data you want to copy |
| 7 | Copy status prompt description |
| 8 | Monitor replication status while copying data |

8-2 Data history

It is a screen for Historical data table.

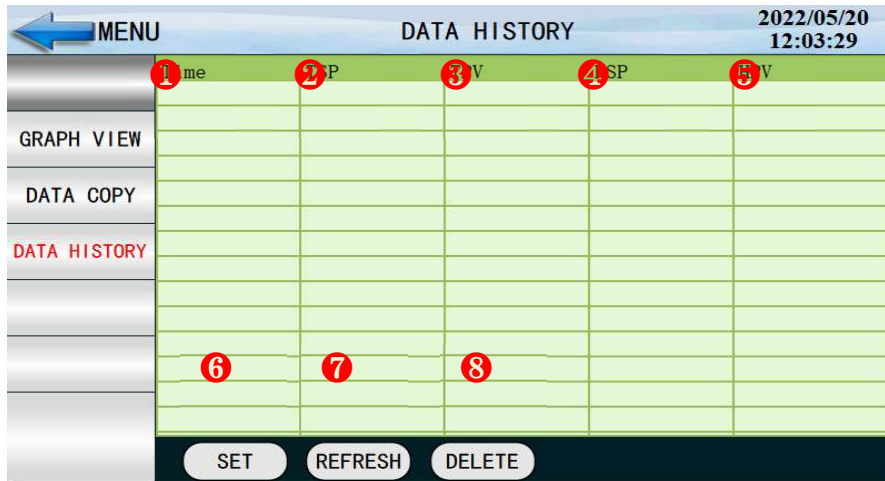

No. Descriptions

- | | |
|---|--|
| 1 | The time point of each data record |
| 2 | Record temperature set point |
| 3 | Record temperature present value |
| 4 | Record the humidity set point |
| 5 | Record the humidity present value |
| 6 | Set query start time point and span time period |
| 7 | Display to update the graph screen immediately which is being saved. |
| 8 | It deletes the entire Historical data table. (Permission is operator, password 666666) |

09. Program set

It converts to [Fig9-1 program set] when the program setting button is touched by in [Fig. 2-1 Main screen]. It is a screen group to set the parameters related to the program operation.



← MENU NAME: _____ 2022/05/20 12:49:08

	NO.	TEMP	HUMI	T. /H	T. /M. S	TS1	TS2	TS3	WAIT
PATTERN SET	1	0.0	0.0	0	0.00	0	0	0	0
WAIT SET	2	0.0	0.0	0	0.00	0	0	0	0
REPEAT SET	3	0.0	0.0	0	0.00	0	0	0	0
PATTERN NAME	4	0.0	0.0	0	0.00	0	0	0	0
TIME SIGNAL	PTN NO.	1	INSERT	DELETE	PG. UP	PG. DN			
	PTN VIEW		COPY PTN	DEL. PTN	COPY U	COPY HM I			

9-1 Program pattern set

It is a screen to set the segment depending on the pattern number.

Refer to [6-4 Time signal operation] for time signal setting.

Please refer to the [6-5 Standby operation] to find things about the standby operation.

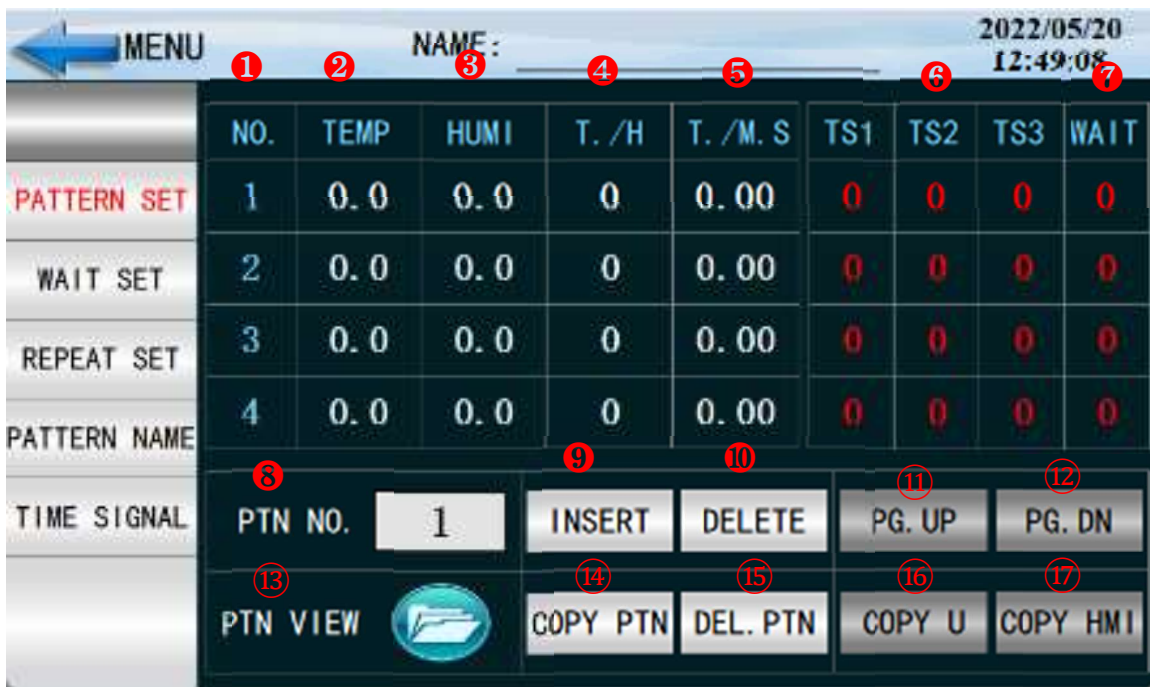

No. Descriptions

- 1 The time point of each data record
- 2 It sets the temperature set value of segment to be operated.
- 3 It sets the humidity set value of segment to be operated.
- 4 Setting the T/H of segment to be operated.
- 5 Setting the T/M. S of segment to be operated.

It sets the time signal of the segment to be operated.

6 4time signals can be set for each segment and each time signal is set by selection from 18 types of time signal. Refer to [9-5 Time signal operation]

7 Selection of 1/0 for using the Standby of Segment to operate. Refer to [9-2 Wait set]

8 Input the pattern number for segment setting

9 When one of the buttons SEGMENT **1** (Segment 01~99) is touched by for segment insertion, the selected button SEGMENT **1** (Segment01~99) and insert button are activated and the selected segment can be inserted when INSERT is touched by.

10 When one of the buttons SEGMENT **1** (Segment 01~99) is touched by for segment deletion, the selected button SEGMENT **1** (Segment 01~99) and delete button are activated and the selected segment can be inserted when DELETE is touched by

11 Moving to pgup on the screen by 4 segment units

12 Moving to pgdn on the screen by 4 segment units

13 Preview the PTN in advance

14 Copy all the data of the current PTN to the specified PTN.

15 Delete all data of the current PTN.

16 Copy all the data of the current PTN to the U disk

17 Import the data exported from the U disk into the current PTN.

9-2 Wait set

It is a screen to set the temperature & humidity Stand-by Range and Stand-by Time during Program operation The set standby operation here is applied to [Fig. 6-1 Program pattern setting.

Definition of stand by operation

Conditions for Stand-by Operation Entry ("OR" condition): In case of no entry of either of temperature or humidity into the set range for standby operation within the set segment time -Conditions for Stand-by Operation Release ("AND" condition): In case of entry of temperature and humidity into the set range for standby operation -The stand by time has indefinite value when the standby time is not set (Initial value)



No. Descriptions

1 It sets the temperature range to be applied for standby operation

2 It sets the humidity range to be applied for standby operation.

It sets the standby time to be applied when the indicated data for temperature or humidity does not enter into the standby operation range (TEMP PV or HUMI PV). It standbys indefinitely for entry to the

3 standby operation range when the standby operation time is set in "OHOM."
"OHOM.

It decides either of "Entire" and "Maintain SEG" for stand by operation method

4 Help tips

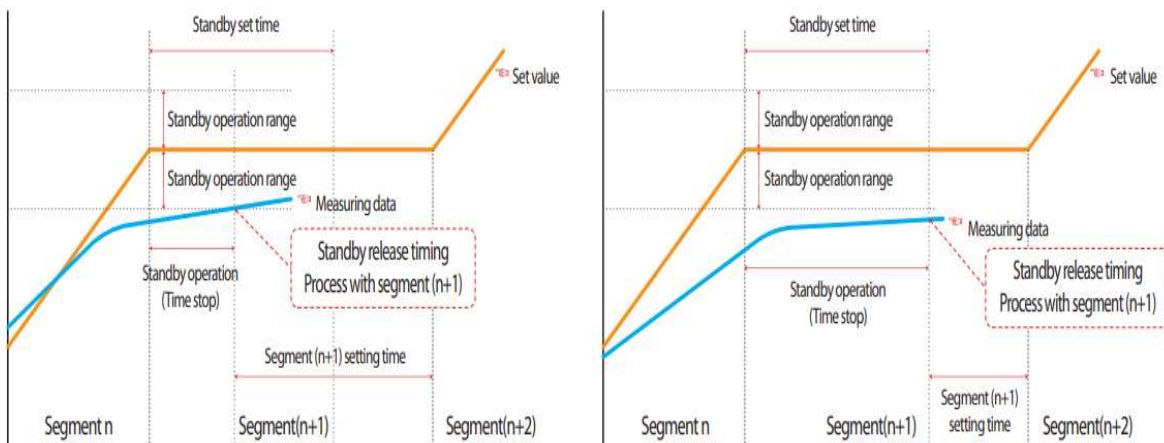

9-3 Pattern repetition set

It is a screen to set the function for entire or partial repetition of set pattern. The operation method in pattern operation termination can be set.

	PTN NO. ¹	REPEAT COUNT ²	LINK PATTERN ³	ENTER ⁴	
PATTERN SET	1	0	0	UPLOAD ⁵	
WAIT SET					
REPEAT SET					
PATTERN NAME	NO. ⁶	NO. 1	NO. 2	NO. 3	NO. 4
TIME SIGNAL	START	0	0	0	0
	END ⁷	0	0	0	0
	COUNT ⁸	0	0	0	0

No. Descriptions

- | | |
|---|---|
| 1 | It sets the pattern number to perform the repetitive operation. |
| 2 | It sets the repetition operation frequency of the set pattern. |
| 3 | It sets the pattern number for repetitive operation in termination of set pattern operation. |
| 4 | Send the current parameters to the controller |
| 5 | Upload the parameters of the controller to hmi |
| 6 | It sets the segment to start the partial repetitive operation out of the set patterns. |
| 7 | It sets the segment to terminate the partial repetitive operation out of the set patterns. |
| 8 | It sets the repetition frequency of the partial repetitive operation out of the set patterns. |

9-4 Pattern name set

The experiment name can be set for each pattern.

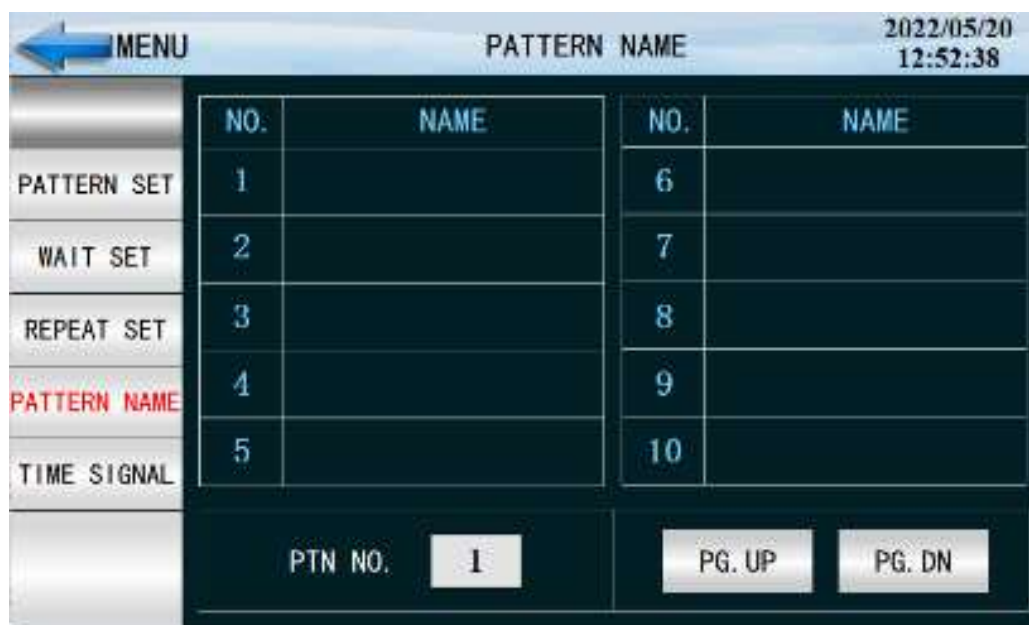

parameter	Setting range	Unit	Initial value
PATTERN NAME	0~9.A~Z. Special letter	ABS	EXPERIMENT OF PATTERN 1~ 100
SET 1~100	(Maximum 24 letters)		

9-5 Time signal operation

The time signal operation is classified into ON/OFF operation, time setting operation and the set time signal is used for setting the time signal No in segment setting in [9-1 Program pattern setting].

The screenshot shows a menu titled 'TIME SIGNAL' with a date and time of '2022/05/20 12:53:47'. On the left, there is a vertical list of menu options: MENU (with a back arrow), PATTERN SET, WAIT SET, REPEAT SET, PATTERN NAME, and TIME SIGNAL (highlighted in red). The main area displays a table with two columns of settings.

NO.	OFF/S	ON/S	NO.	OFF/S	ON/S
0	TS OFF	TS OFF	2	0	0
1	TS ON	TS ON	3	0	0

No. Descriptions

TS1 The time signal is OFF during corresponding segment operation when "0" is selected.

The change is impossible as it is only for reading.

TS2 The time signal is ON during corresponding segment operation when "1" is selected.
The change is impossible as it is only for reading.

OFF The time signal is "ON" after setting time is elapsed in delay time from the corresponding segment starting point.
However, the time signal is not operated when the corresponding segment time is bigger than delay time.

ON The time signal is "ON" by the delay time in corresponding segment is "ON" only for set time in operation time.
However, the time signal is "ON" for the corresponding segment operation when the (delay time + operation time) is bigger than corresponding segment time and it is not operated in the next segment. Moving the screen up/down by 6time signal units. Send the current parameters to the controller

10. Fix set

11. It converts to [Fig10-1 Fix set] when the Fix set button is touched by in [Fig. 2-1 Main screen]. It is a screen for additional setting in stationary operation.



10-1 T&H SLOPE

It is a screen for T&H slope set.



[Fig.10-1] T&H SLOPE SCREEN

No. Descriptions

1	<p>ON: Temperature and humidity are controlled according to the set slope</p> <p>OFF: The temperature and humidity reach the set temperature quickly according to the target set value</p>
2	<p>Automatic increased or decreased with the set rate in case of set value change It is adopted in stationary operation only</p>
3	<p>Automatic increased or decreased with the set rate in case of set value change It is adopted in stationary operation only</p>

Setting value change rate (SLOPE) operation

The set value is changed by fixed changing rate from the current value (PV) to the set value when the set value is changed

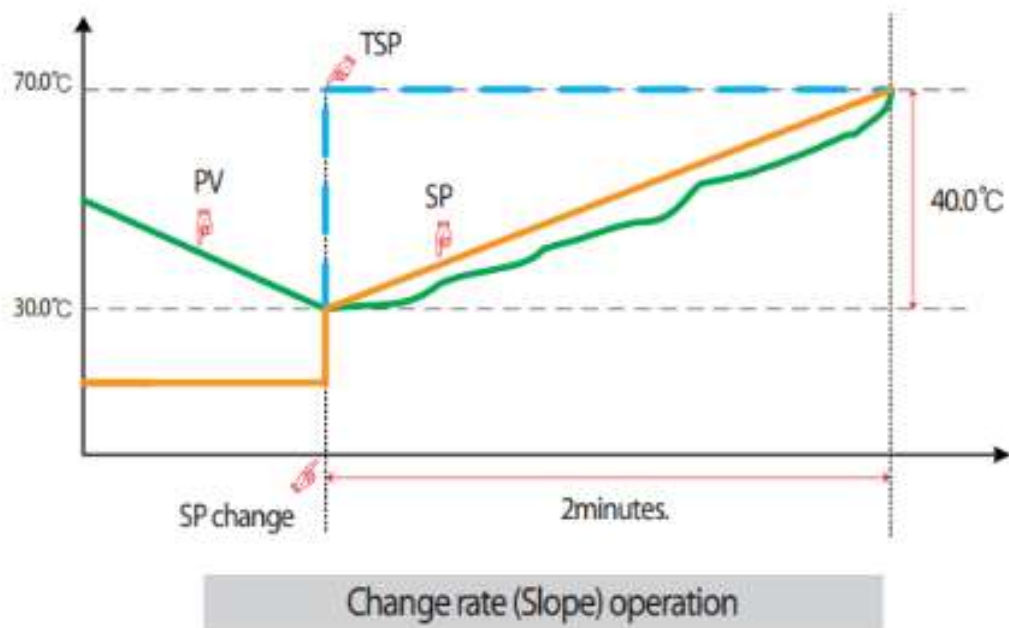

References

- ▶ Operation method: Stationary operation
- ▶ Temperature change rate: 20.0°C/Min
- ▶ Change [Changed SP(TSP) - PV at the SP changing point] with slope of 20.0°C per minute: $(70.0 - 30.0)^\circ\text{C} = \text{Change } 40.0^\circ\text{C}$ with the slope of 20°C
- ▶ Increase the current set value (SP) from 30.0°C to 70.0°C with uniform increasing rate for 2 minutes.

10-2 Fix set

It is a screen for Fix set.



[Fig.10-2] FIX set SCREEN

No. Descriptions

1 Manual: The machine needs to be manually triggered to stop

Time: After the time is up, the machine stops automatically

2 Set the time to stop the timer

Auto: Start timing immediately after the machine starts

3 Time: After the machine is started, the time will start when the temperature and humidity reach a certain range.

4 Set the temperature to the timer, the corresponding temperature and humidity range value

10-3 Stop temp

It is a screen for Stop temp set.



[Fig.10-3] Stop SCREEN

No. Descriptions

1 OFF: The fix set return to normal temperature function is turned off

ON: The fix set return to normal temperature function is turned on

2 Set value back to normal temperature, temperature and humidity set

value