

**18 INCH RGBW
RING LIGHT**



Welcome to the #influencer
18 Inch RGBW Ring Light.
Here are the instructions on how
to set-up your light so you can
get on with creating content.

VLM13003

*Ring light is 18 inch high as measured
from mounting point to top of the ring.

INCLUDED



Ring light



Remote Control



1/4 Inch
Camera Mount



User Manual

PRODUCT STRUCTURE & FUNCTIONS

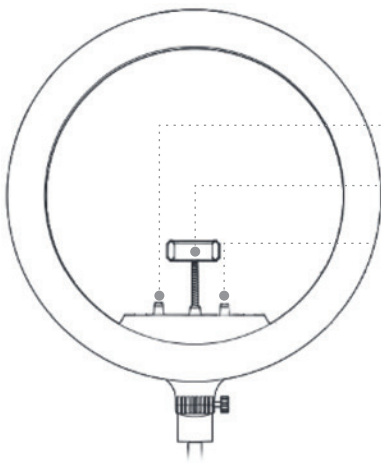

Colour Mode / Control Dial
ON/OFF Button

Phone Holder

ON/OFF Button

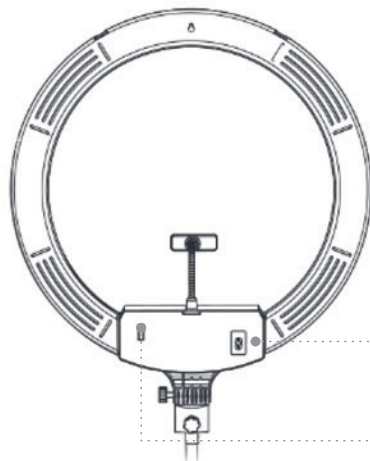

Night Light Mode

Dimming
(^>Brightness+)
(v>Brightness-)

RGB

Colour Temperature -

Switch Back to Default

Colour Temperature +

Power Interface

USB Port



ASSEMBLY

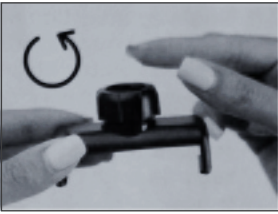

STEP 1:
Locate the device holder and unthread the rigid cap by turning counter clockwise.

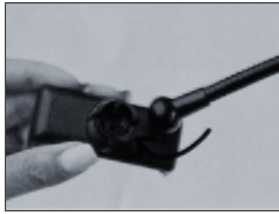

STEP 2:
Take the ball joint connector and snap the rounded end into the back of the device holder. Slide the rigid cap down the connector and thread it back into place by turning clockwise.

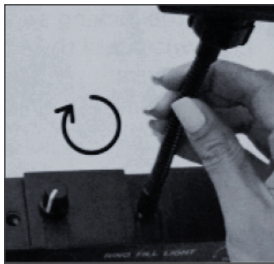

STEP 3:
Thread the skinny end of the ball joint connector into the screw hole located at the top of the base panel.

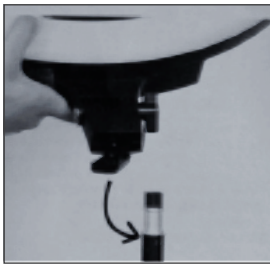

STEP 4:
Locate the screw hole located at the base of the LED ring light. Place the ring light directly on the tripod stand.

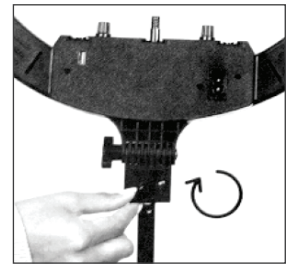

STEP 5:
Twist the locking screw knob clockwise until the ring light feels secure.

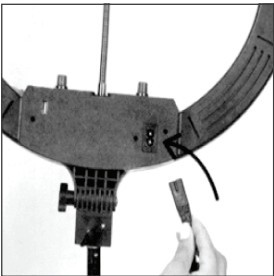

STEP 6:
Connect the AC power cord to the 2 prong power port located on the back of the panel of the ring light. Plug into an outlet or power source.

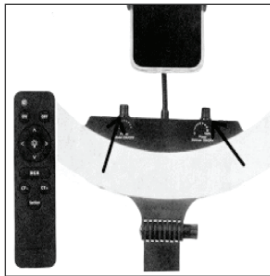

STEP 7:
Power the ring light only by pressing down on one of the dials located on top of the base panel. You can also power the ring light by using the included remote.

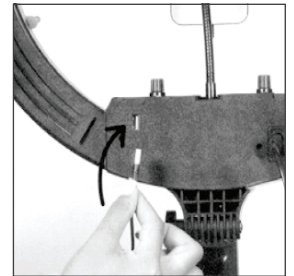

STEP 8:
Optional - Charge your device while in use by connecting your phone's charging cord to the USB port located on the back panel of the ring light.

INSTALLATION (Camera)

- Screw the 1/4 Inch adaptor into one of the 3 screw holes
- Screw the ball mount into the base of the camera
- Screw the base of the ball mount onto the top of the 1/4 inch adaptor
- Adjust the angle of the ball joint to desired angle and secure by tightening the screw on side
- Ensure all bits are secure before releasing hold of camera.

SPECIFICATIONS:

4 Colour modes:	warm white, cold white, natural & RGB
LED's:	408pcs - 336 white + 72 RGB
Light temperature:	3000-6000K
Adjustable brightness:	10%-100%
Input voltage:	240V, 50-60hz
Max power input:	50W
Max power output:	35W
USB output:	5V 2A
CRI:	>70
Remote:	2 x AAA batteries (not included)

WARNINGS: READ BEFORE USING

Photosensitivity / epileptic seizures:

A very small percentage of individuals may experience epileptic seizures when exposed to certain light patterns or flashing lights. Exposure to certain patterns or backgrounds on a computer screen, may induce an epileptic seizure in these individuals. Certain conditions may induce previously undetected epileptic symptoms even in persons who have no history of prior seizures or epilepsy. If you, or anyone in your family, have an epileptic condition, consult your physician prior to using. If you experience any of the following symptoms while using the product -- dizziness, altered vision, eye or muscle twitches, loss of awareness, disorientation, any involuntary movement, or convulsions - IMMEDIATELY discontinue use and consult your physician before resuming using.

Influencer™

PO Box 5658 Brendale QLD
Australia 4500
Customer Support 1800 812 261

