

## 14 INCH RGBW RING LIGHT

Welcome to the #influencer 14 Inch RGBW Ring Light. Here are the instructions on how to use your ring light so you can get on with creating content.

### FEATURES

- 14 Inch RGB Ring Light: Choose from six (6) different RGB colours, three (3) White Light modes, eight (8) RGB special effect lighting modes, and adjustable brightness.
- Easy to use in-line remote to power on/off and switch to the lighting mode / effect mode you prefer.
- Compatible with most smartphones, phone clip opens up to 3.6" .
- Great for vlogging, live videos, video chats, social media, live streaming, health and beauty videos, and more.
- USB powered: No battery required, works with most devices that have a USB port: Computer, Laptop, USB Wall Charger, Power Bank, etc.



**VLM13002**

\*Ring light is 14 inch high as measured from mounting point to top of the ring.

## INSTALLATION (Flexible Phone Mount to Ring Light)

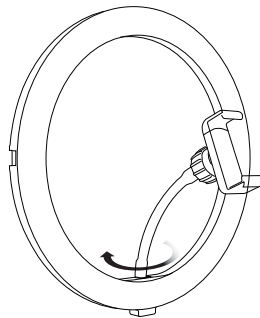
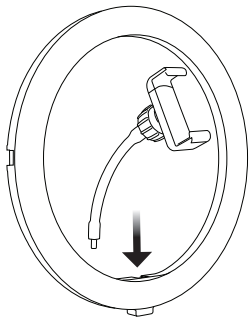

### STEP 1:

Attach Phone Clip with Flexible Mount to Ring Light by screwing in.

## INSTALLATION (Ball head to ring light)

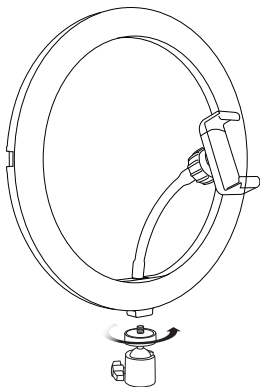

### STEP 1:

Screw 360° Ball Head into the bottom of Ring Light.

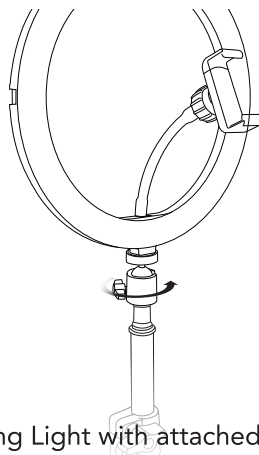

### STEP 2:

Screw Ring Light with attached 360° Ball Head into Tripod

## INSTALLATION (Insert Smartphone/Connect to USB Port)

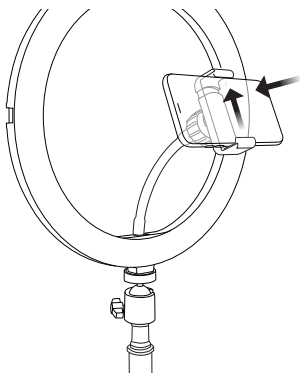

### STEP 1:

Open up Phone Clip and insert Smartphone. Opens up to 3.6".

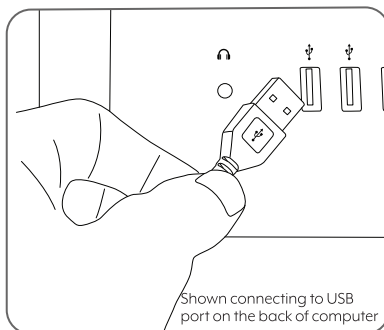

### STEP 2:

Plug in USB cable into a USB port: Computer, Laptop, Wall Charger, Power Bank, etc.

# HOW TO USE (Remote Control)

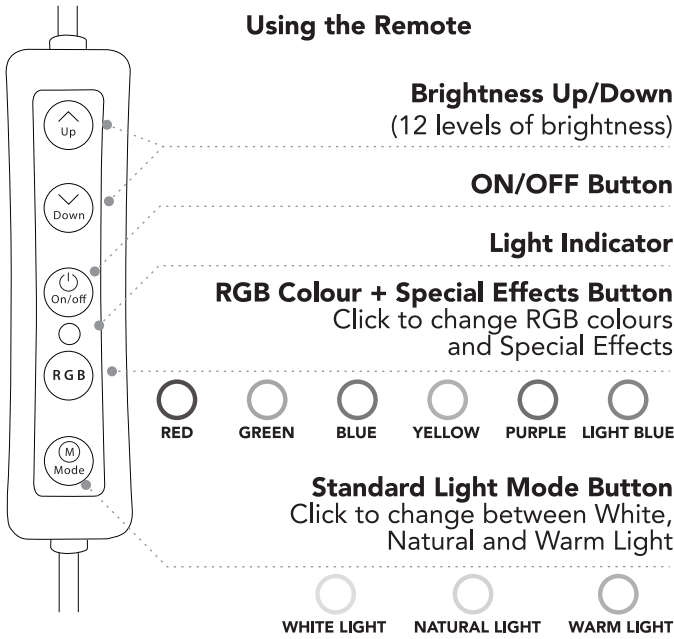

## SPECIAL EFFECT MODES

The ring light illuminates 9 different colours + 8 Special Effect lighting modes. Click on the RGB button to cycle through each RGB colour and Special Effect.

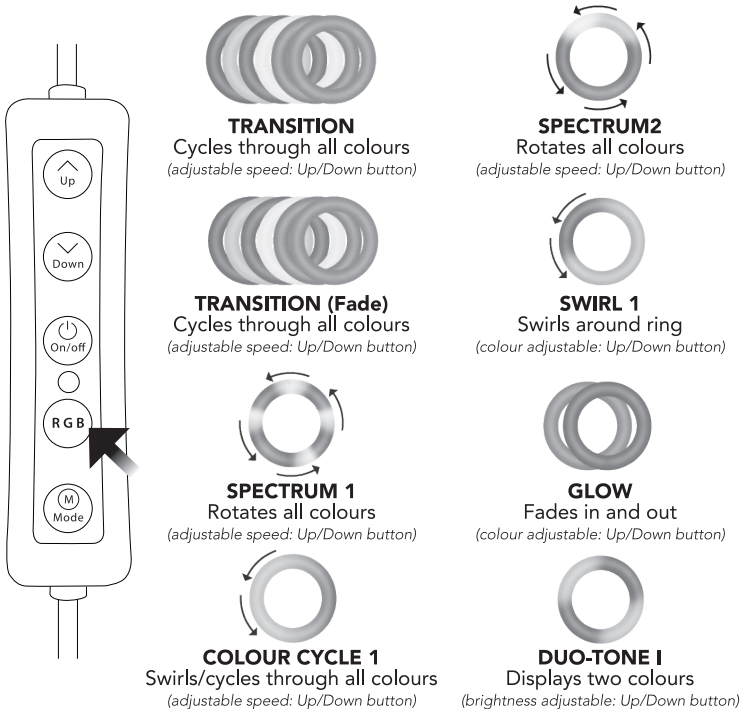

## INSTALLATION (Camera)

- Screw the 1/4 inch camera mount to the base of the camera
- Slide the cold shoe base of mount into the slot on the ring light
- Tighten the locknut by turning clockwise until tight and camera is secure
- Rotate the middle section of the mount so that you can tilt the camera to the desired angle
- Once the camera is at the right angle tighten the side bolt to hold in place.

## USB POWER

Connect to suitable USB source providing 5V D.C. 2A (10W).  
(USB Adaptor not included)

## SPECIFICATIONS:

Ring light size:	14 inch diameter
Lamp beads:	208 pcs.
Color temperature:	3000-5000K
Power:	10W
Power supply:	USB Interface
CRI:	>85
Light colors:	9 colours (Including white/warm/natural light), 8 special effects, 12 levels of brightness

### WARNINGS: READ BEFORE USING

Photosensitivity / epileptic seizures:

A very small percentage of individuals may experience epileptic seizures when exposed to certain light patterns or flashing lights. Exposure to certain patterns or backgrounds on a computer screen, may induce an epileptic seizure in these individuals. Certain conditions may induce previously undetected epileptic symptoms even in persons who have no history of prior seizures or epilepsy. If you, or anyone in your family, have an epileptic condition, consult your physician prior to using. If you experience any of the following symptoms while using the product -- dizziness, altered vision, eye or muscle twitches, loss of awareness, disorientation, any involuntary movement, or convulsions - IMMEDIATELY discontinue use and consult your physician before resuming using.

### Influencer™

PO Box 5658 Brendale QLD  
Australia 4500  
Customer Support 1800 812 261

