Club LE Pedicure Chair



© Copyright 2020
Living Earth Crafts®

All rights reserved. This document or any portion thereof may not be reproduced in any way, including photocopying or translation to another language without the prior written permission from Living Earth Crafts.

Living Earth Crafts® is a registered trademark of Earthlite, LLC,

Legal Notice

The information provided in this document is intended for informational purposes only and is subject to change without notice. The information provided in this document should not be construed as a commitment by Living Earth Crafts®.

Living Earth Crafts® assumes no responsibility for the accuracy or suitability of the information contained in this document. This document may contain technical inaccuracies or errors. Living Earth Crafts® makes no expressed or implied warranties of any kind concerning the information contained in this document, including, but not limited to, the implied warranties of merchantability and fitness for purpose.

Living Earth Crafts® shall not be liable for incidental or consequential damages in connection with or arising out of the product, performance, or use of this document and the information and material it describes.

Introduction

Congratulations on your purchase of the Club LE pedicure chair. The Club LE offers an unparalleled pedicure and hydrotherapy experience, featuring a luxurious, handcrafted chair and a jetted tub. The tub basin is lined with soothing textured foot pebbles to give your client's feet a relaxed, massaging sensation.

The Club LE is designed for licensed therapists and technicians and is intended to be used in a professional spa, salon, or similar commercial environment. While no special training is needed to operate the product, for safety reasons it is important that the instructions contained in this manual are reviewed in detail before the first use. This manual should be read in its entirety by each professional who will be operating the product to ensure the safety of both operator and client. This manual should be saved for future reference.

The Club LE should not be used in any other manner than described in this manual. Please read, understand, and follow all safety warnings, labels, and instructions. Misuse, use of unnecessary force, or using the chair for unintended or unauthorized procedures can result in injury to operator, client, and/or equipment.

Detailed instructions for use and maintenance can be found in this user manual. If you have further questions, please contact us at (800) 358-8292 for US customers, or (760) 597-2155 for international customers. We can also be reached via e-mail at info@livingearthcrafts.com

Table of Contents

Section 1: Safety Information

Safety Symbols/Warnings.....	2-3
------------------------------	-----

Section 2: Product Overview

Product Diagram.....	4
Product Specifications	5

Section 3: Operating Instructions

Retractable Tub.....	6
Power Back Tilt	6
Water Fill Valve	6
Jet & Light	7
Drain Release & Discharge Pump	7
Footrest Operation.....	8
Electrical Specifications	8
Swingaway Manicure Trays.....	9
Relaxor	10

Section 4: Care & Maintenance

Cleaning & Ongoing Maintenance	11
Tub Cleaning Guide	12-13
Troubleshooting	14
Warranty Information	15

Section 5: Installation

Technical Drawings	16-17
Backflow Prevention	18-19
Contact Us	back cover

SECTION 1: SAFETY INFORMATION

Safety Symbols

Familiarize yourself with the following Safety & Warning symbols. They are designed to prevent damage and injury to you, your clients, and your new Living Earth Crafts product.

IMPORTANT: The important safety instructions and warnings in this manual cannot cover all possible problems and conditions that can occur. Use common sense and caution when installing, operating, or maintaining this appliance.



Indicates an imminently hazardous situation which could result in serious or fatal injury.



Indicates a potentially hazardous situation which could result in serious injury.



Indicates a potentially hazardous situation which could result in equipment damage and/or injury.

IMPORTANT SAFETY INSTRUCTIONS - FOR COMMERCIAL USE ONLY

Read all instructions before using this product.



RISK OF ACCIDENTAL INJURY OR DROWNING. DO NOT USE DRUGS OR ALCOHOL BEFORE OR DURING USE. CHILDREN OR HANDICAPPED PERSONS SHOULD NOT USE WITHOUT SUPERVISION.

WARNING - RISK OF HYPERTHERMIA AND POSSIBLE DROWNING. WATER TEMPERATURE IN EXCESS OF 38°C or 100.4°F CAN BE INJURIOUS TO YOUR HEALTH. CHECK AND ADJUST WATER TEMPERATURE BEFORE USE.

Hyperthermia occurs when the internal temperature of the body reaches a level several degrees above the body temperature of 98.6°F or 37°C. The symptoms of hyperthermia include an increase in the internal temperature of the body, dizziness, lethargy, drowsiness, and fainting. The effects of hyperthermia include:

- Failure to perceive heat,
 - Failure to recognize the need to exit the hydromassage bathtub,
 - Unawareness of impending hazard,
 - Fetal damage in pregnant women,
 - Physical inability to exit the hydromassage bathtub, and
 - Unconsciousness resulting in the danger of drowning.
- WARNING - The use of alcohol, drugs, or medication can greatly increase the risk of fatal hyperthermia.

WARNING - RISK OF ELECTRIC SHOCK - Do not permit electric appliances (such as hair dryers, lamp, telephone, radio, or television) to be within 5 ft (1.5m) of this unit.

WARNING - RISK OF INJURY - Exercise care when using a foot bath. Use this product for its intended purpose: a manicure chair and fill and drain indoor commercial appliance for foot and ankle hydro massage. DO NOT use attachments not recommended by manufacturer.

WARNING - MOVABLE PARTS, RISK OF INJURY:

- Keep children away from adjustable seat armrests, tilt back, and seat slide, and footrest.

WARNING - To reduce the risk of burns, fire, electric shock, or injury to persons:

- Unplug from outlet before putting on or taking off parts.
- Close supervision is necessary when this furnishing is used by, or near children, invalids, or disabled persons. DO NOT leave children alone or allow them to operate the controls. Keep controls out of reach of children. DO NOT allow children to crawl behind the chair.
- Never use this furnishing if it has a damaged cord or plug, if it is not working properly, if it has been dropped or damaged, or dropped into water. Return the furnishing to a service center for examination and repair.
- Keep the cord away from heated surfaces.
- Never operate the furnishing with the air openings blocked. Keep the air openings free of lint, hair, etc.
- Never drop or insert any object into any opening.

SECTION 1: SAFETY INFORMATION

WARNING

- DO NOT reach for any electrical object that has fallen into the water. Unplug immediately.
- DO NOT drop or insert anything into jet opening.
- DO NOT operate without the complete jet assembly installed or without water filled 1 inch above jet.
- DO NOT overfill the basin.
- DO NOT stand on or in the basin, or on the foot rest.
- DO NOT leave this appliance unattended when in operation.
- DO NOT use outdoors.
- DO NOT retract tub when water is in basin.
- Keep the electrical cord away from heated surfaces.
- Connect this appliance only to a properly grounded outlet.
- To avoid injury, exercise care when entering or exiting the chair and foot bath.
- Use caution when making positioning adjustments to your chair. Keep all equipment and body parts away from moving parts while making any adjustments.
- It is important that you clean and disinfect the jet and basin after every use.
- Hydrotherapy should be pleasant and comfortable. Should you or a client experience any pain or discomfort while using the foot bath, discontinue use immediately and consult a physician.
- You or your clients should consult a physician if diabetic, have poor circulation, if feet or legs are inflamed, have an open wound, or if you have questions about whether you should be using hydro massage equipment.
- A qualified plumber and electrician are strongly recommended to install your foot bath.
- Make certain that the cord and plug are maintained in good condition and are not allowed to become damaged while in use. Avoid positioning the cord in the traffic lane and it is always kept out of the way. Take this furnishing out of service immediately if the cord or plug becomes damaged in any way.
- Do not attempt to repair. All repairs must be performed by an authorized service representative.
- Chair and tub are to remain right side up. At no time should chair or tub be turned on it's side or upside down.



INSTALLATION INSTRUCTIONS / GROUNDING INSTRUCTIONS

1. RISK OF ELECTRIC SHOCK. Connect only to a circuit protected by a ground-fault circuit-interrupter.

2. Grounding is required. The unit should be installed by a qualified service representative and grounded.

This product must be grounded. If it should malfunction or break down, grounding provides a path of least resistance for electric current to reduce the risk of electric shock. This product is equipped with a cord having an equipment-grounding conductor and grounding plug. The plug must be plugged into an appropriate outlet that is properly installed and grounded in accordance with all local codes and ordinances.

Improper connection of the equipment-grounding connector can result in a risk of electric shock. Check with a qualified electrician or serviceman if you are in doubt as to whether the product is properly grounded. Do not modify the plug provided with the product - if it will not fit the outlet, have a proper outlet installed by a qualified electrician.

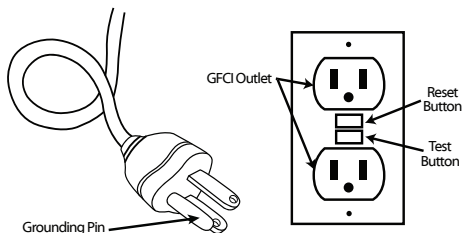

READ AND SAVE THESE INSTRUCTIONS

SECTION 2: PRODUCT OVERVIEW

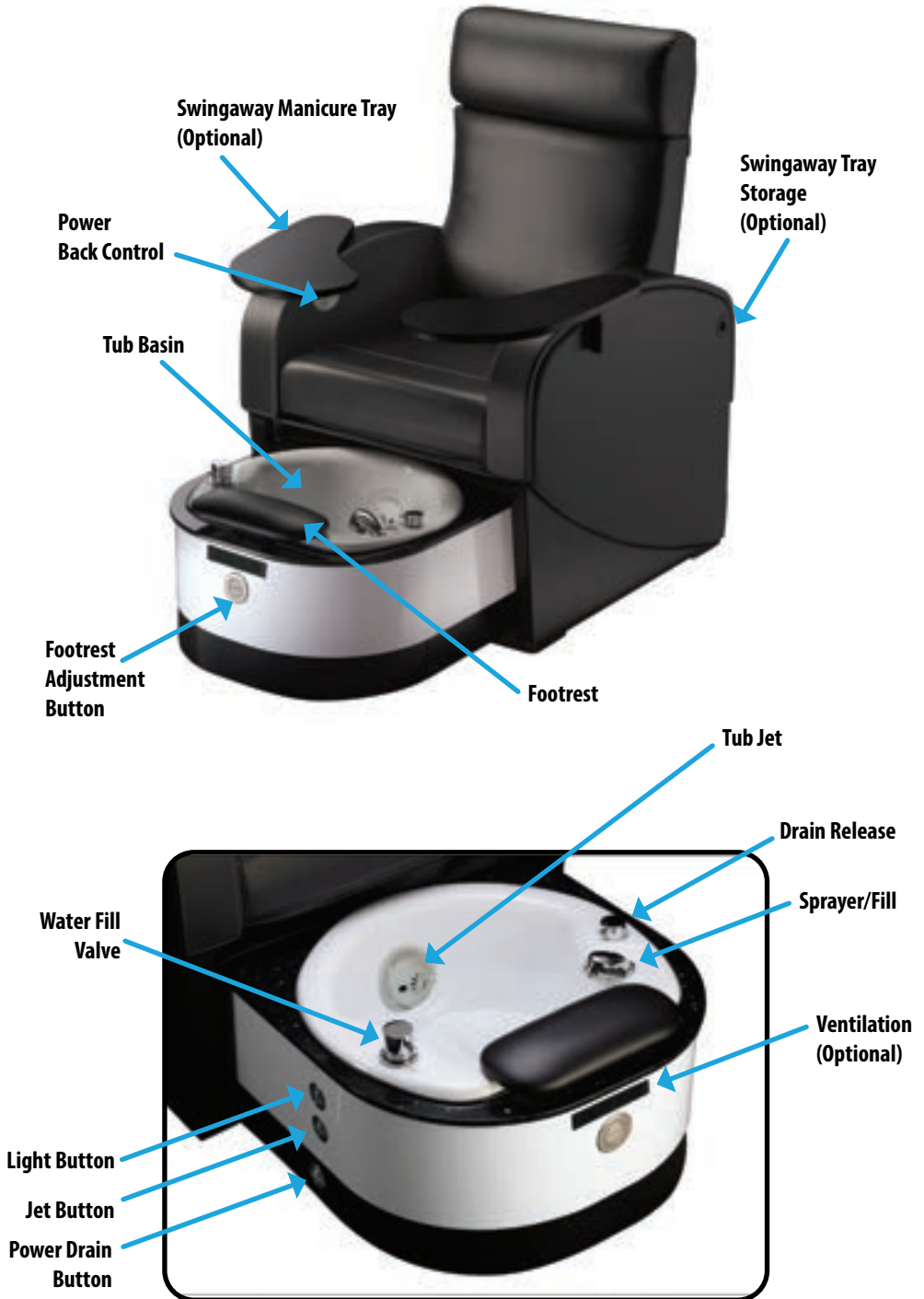

SECTION 2: PRODUCT OVERVIEW

Product Specifications

Overall Width	31" (79 cm)
Tub/Shroud Width	25.25" (64 cm)
Tub Height (to footrest)	16.5" (42 cm)
Length (chair only)	35" (89 cm)
Length (chair w/tub)	57.5" (146 cm)
Chair Height	50.25" (128 cm)
Seat Height	22" (56 cm)
Backrest Tilt	15 degrees

**Measurements may vary due to natural material variations.*

Included Features

Feature	Standard	Optional
Pipeless Jet	X	
Reflexology Acrylic Tub	X	
Power Back Tilt	X	
Fully Motorized Footrest	X	
Motorized Retractable Tub	X	
Power Drain/Discharge Pump	X	
Ventilation		X
Relaxor® Heat & Massage		X
Swingaway Manicure Trays		X
Avonite/Glass Top	Standard Options	Upgraded Options
Upholstery	Nature's Touch	Promessa®, Ultraleather®, or Urban Fabrics

SECTION 3: OPERATING INSTRUCTIONS

Retractable Tub Operation

Your Club LE has a tub that conveniently retracts underneath the chair for manicure positioning.



Always use extreme caution when making any position adjustments to your chair/tub. Ensure all body parts and objects are clear from all moving parts. DO NOT retract tub when water is in the basin.

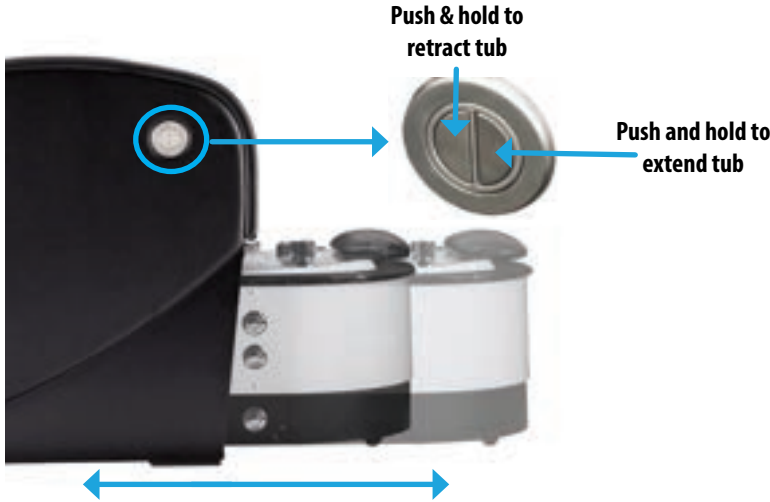

Power Back Tilt Operation

Your chair is equipped with a power recline button located on the inside of the right arm of the chair. See below for instructions on how to operate.



Water Fill Valve

The water fill valve is OFF when pointing DOWN. Water dispenses when you pull the valve UP. For hot water, turn valve to the RIGHT. For cold water, turn valve to the LEFT.



There is no automatic shutoff with the water fill valve. You MUST turn the valve OFF after the tub is filled to prevent overflow and/or flooding. Do not walk away from the tub when it is filling with water.

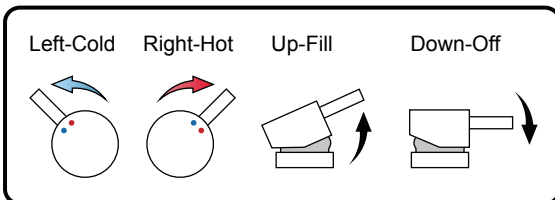

SECTION 3: OPERATING INSTRUCTIONS

Pipeless Jet & Chromasoothe Light

Pressing the respective On/Off button once will turn on the jet or light, and pressing the button again will turn it off. Turn on the jet **ONLY AFTER** the tub is filled with water, and ensure you turn the jet OFF before draining the tub.



Running the jet without filling the tub with water can damage or destroy the jet. Ensure that a **MINIMUM** of one (1) inch of water is above the jet prior to use.

Light Button
Jet Button



Drain Release & Discharge Pump Operation

- Turn the drain knob clockwise to close the drain when filling the tub.
- Turn the knob counterclockwise to open the drain and empty the tub.
- Discharge pump button is location directly below the jet/light button. Before pressing the button, open the drain with the drain knob and let the water start draining towards the pump. Wait approximately 5-10 seconds for the pump to register, then push the discharge pump button.

Discharge
Pump
On/Off Button



Drain
Release

SECTION 3: OPERATING INSTRUCTIONS

Footrest Operation



Always use extreme caution when making any position adjustments to your footrest. Ensure all body parts and objects are clear from all moving parts.



Do not sit on or put full body weight on the footrest. It is meant only to support a client's feet for a pedicure, not to support body weight.

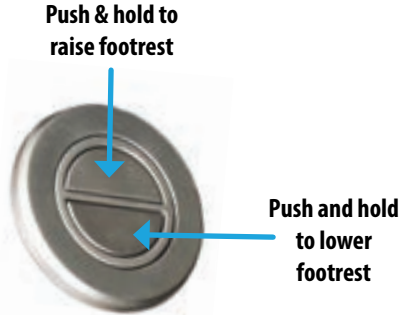

Electrical Specifications

Spec	North America	Europe/Asia
Input Voltage	120 VAC	220 VAC
Input Frequency	60 Hz	50 Hz
Total Consumption - Standard Features	5.9 Amps, 708 Watts	3.2 Amps, 708 Watts
Consumption - Relaxor	Additional 4 Amps, 480 Watts	Additional 2.2 Amps, 480 Watts

Discharge Pump Specification

Motor Design	Single-phase synchronous motor
Flow Rate (120V)	24 l/min at 0, 1 bar
Flow Rate (220V)	20 l/min at 0, 1 bar
Duty Cycle	Continuous

SECTION 3: OPERATING INSTRUCTIONS

Swingaway Manicure Trays (Optional)

The Swingaway Manicure Trays are a convenient way to offer manicure services in your pedicure chair. See below on how to install and store your trays.

To Set Up:

Insert the tray post into the receiver and push straight down to secure.



To Store:

Insert the tray post into the storage receiver, and push all the way in to prevent the tray from falling out.

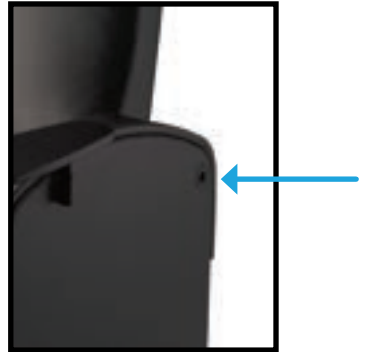

To Remove:

Lift tray evenly with one hand placed on either side of the receiver. Tray may get stuck if only lifted from one side.

Tray Positioning

The manicure trays can easily be swiveled to any position that is desired. Below are the most commonly used tray positions and their functions.

Position 1: Places trays closer to the client and allows the magnetic center tray to be attached.

Position 2: Places trays closer to the technician and provides more room for the client.

Position 3: Allows the trays to function as extended armrests or table.

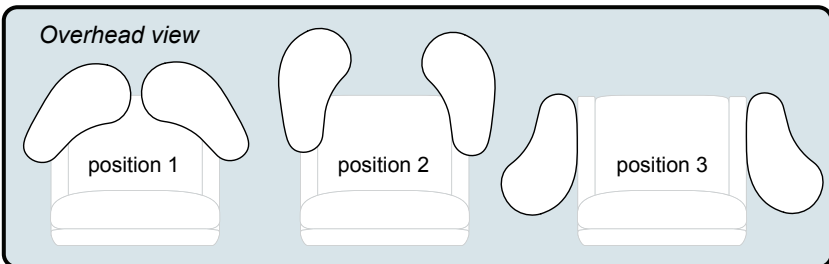

Magnetic Center Tray (Optional)

The Magnetic Center Tray provides even more surface area for your manicure services. Place the center tray on the Swingaway Manicure Trays, and move it slightly back and forth until the magnets “catch”. The finished configuration will look like the photo below:



SECTION 3: OPERATING INSTRUCTIONS

Relaxor® Heat & Massage (Optional)

The following diagrams illustrate the ease-of-use and functionality that the Relaxor® system provides to you and your clients.



RISK OF ELECTRIC SHOCK

Keep hand control and all electrical components away from water.

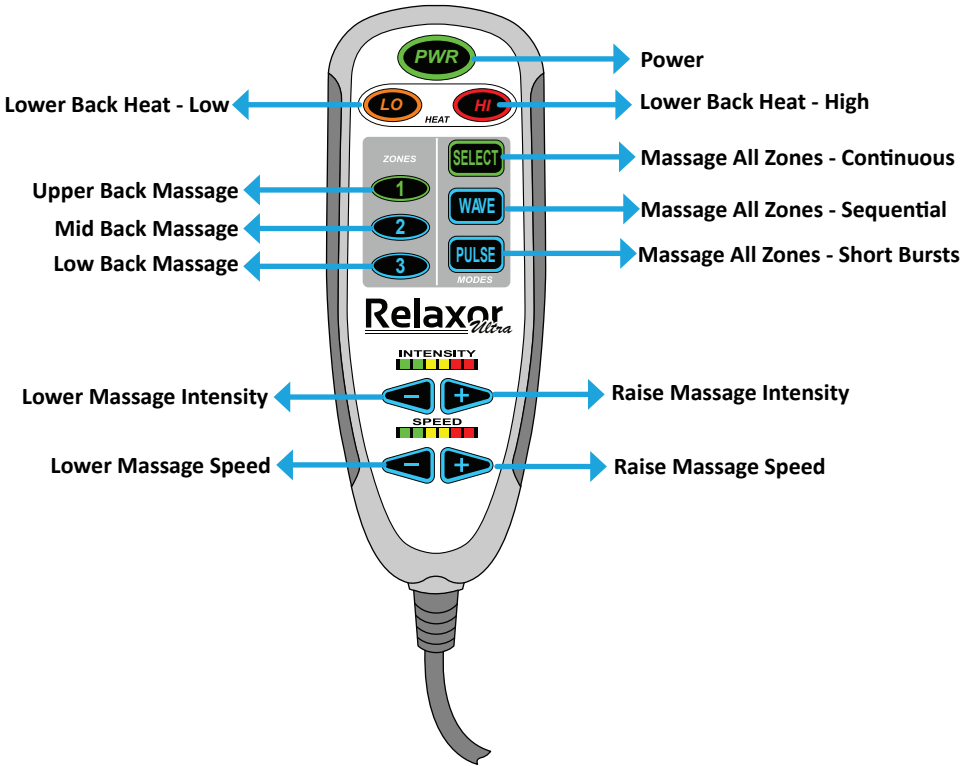

Symbol	Description
	• Massage 15 Minute Timer (Standard)
	• Massage 30 Minute Timer (Hold Down Button)
Green Light	• Indicates Active Button
Blue Light	• Indicates Normal Standby
Red Light	• Indicates High Mode
Orange Light	• Indicates Low Mode

SECTION 4: CARE & MAINTENANCE

Cleaning & Ongoing Maintenance

The following procedures are important guidelines that will help in keep your Club LE clean and trouble free for years. It is extremely important to clean and disinfect each and every pedicure chair after each pedicure and after the last pedicure of the day. (See next page for instructions.)

YOU ARE REQUIRED TO CHECK WITH YOUR STATE BOARD FOR MANDATORY CLEANING AND DISINFECTING REQUIREMENTS AND PROCEDURES.



DO NOT USE acetone, paint thinner, "Armor All" type cleaners, or industrial cleaners for ANY part of your chair, tub, or components.

DO NOT place nail care products on the tub.

Extended exposure to harsh chemicals can damage the basin, footpad, and/or upholstery. Failure to comply with all cleaning instructions can cause damage and void your warranty.

Category	Care Recommendation
Upholstery	<p>Remove day-to-day dirt and smudges with a mild soap and water solution. For tough stains and to disinfect, use a (100 to 1) water to bleach solution. Spray a damp cloth with the solution to clean.</p> <p>After each cleaning, gently wipe the upholstery with a damp cloth and clean water, then allow upholstery to air dry before using or storing.</p> <p>For more difficult stains, please contact your dealer or please call us directly for guidance. For best results, use only the products suggested above.</p>
Laminate	<p>Never use abrasive cleaners. A mild liquid detergent and warm water will clean soiled surfaces. To avoid discoloration, cleaners containing petroleum distillates must not remain on surfaces.</p>
Basin-Acrylic/ Capped/ Fiberglass	<p>Do NOT use abrasive pads or cleaners on any surface. Wipe clean with a sponge or soft brush. Follow State's cleaning and disinfecting procedures.</p>
Stubborn Dirt, Stains, or surface imperfections	<p>Occasionally stains will not be removed by the above steps, in this case the use of a Mr. Clean® Magic Eraser will allow for a more aggressive cleaning without damaging the surface finish. Use the Magic Eraser following the directions on the package.</p>
Footrest	<p>A mild detergent and warm water is all that is needed to clean the padded footrest. However care should be taken to prevent nail polish or acetone from coming in contact with the footrest. These products may damage or discolor the upholstery. In spite of taking necessary precautions to protect the leg supports, hard water and/or certain products may cause the black footrests to develop a white film or some discoloration. If this occurs, use a product called "Black Max"- Vinyl and Rubber Dressing.</p>

SECTION 4: CARE & MAINTENANCE

Tub Cleaning Guide



Always refer to your state and local codes for specific cleaning requirements. NEVER USE abrasive cleaners on any surface area. Failure to comply can cause damage and void your warranty.

The removable jet assembly MUST be placed into the motor housing in the correct order and position or the jet may be damaged. This will NOT be covered by any Living Earth Crafts warranty. Never turn the jet on without adequate water in the basin. There must be at least one (1) inch of water above the motor housing.

Recommended Cleaning and Disinfecting Products

Your state board requires disinfecting of your pedicure basin. Living Earth Crafts recommends "Splish Splash One-Step Disinfectant."

While other EPA registered products are available for maintaining pedicure tubs, we have found Splish Splash to be the most effective, multi-purpose and economical product on the market.

Products NOT Recommended

- Silicate based bath additives/scrubs - may void warranty.
- Oil-based products.
- High foam agents (use only low foam solutions).
- Abrasive cleaners that might damage the system components, and scratch/dull the basin surface (major scratches will require professional refinishing).
- To avoid discoloration, products with petroleum distillates must not remain on surfaces.

Tub Liners

Tub liners may be used with this system - it must sit between the housing and the impeller.

Jet System Components

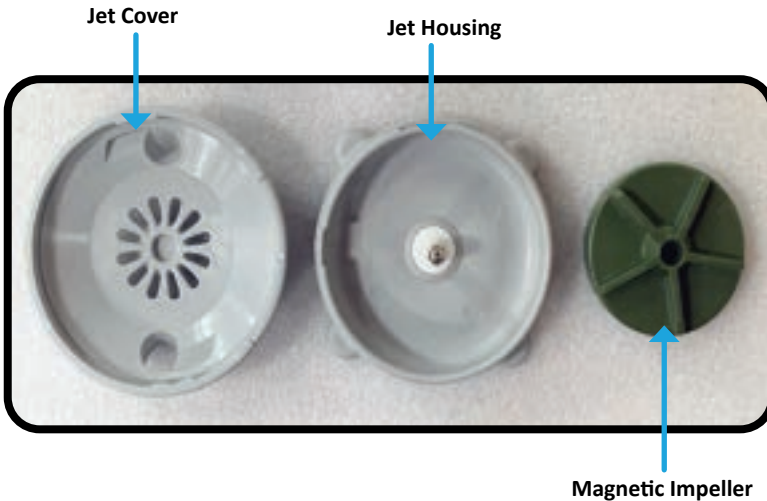

SECTION 4: CARE & MAINTENANCE

Tub Cleaning Guide

Cleaning After Each Client & End of Day

1. Drain the tub of all water.
2. Firmly pull the jet assembly away from the tub to remove. (Fig. 1)
3. Rotate the cover to unlock and separate the cover, magnetic impeller, and housing. (See Fig. 2 to show how to unlock, See previous page for image identifying jet assembly parts.)
4. Place jet cover, impeller, and housing into a sink. Use a non-abrasive liquid soap and a clean brush to remove any visible residue. Rinse with fresh water, and dry with a clean paper towel.
5. Reassemble the jet assembly and reattach to the tub.
6. Fill basin with warm water and add the correct amount of an EPA-registered liquid disinfectant (Splish Splash strongly recommended). Turn on the jet to circulate the water for at least 10 minutes, scrubbing all visible residue from the inside walls of the basin with a sponge/soft brush. NOTE: Brushes must be cleaned/disinfected after each use.
7. Drain the basin, rinse with fresh water, and wipe dry with a clean paper towel.



Fig. 1



Fig. 2

Cleaning Every Other Week

1. Fill tub with water and one-third (1/3) cup of 5.25% chlorine bleach for each one (1) gallon of water. (An alternative to bleach would be an EPA-registered disinfectant with demonstrated bactericidal, fungicidal, and virucidal activity.)
2. Turn on the jets to circulate the solution for 5-10 minutes and then sit for 6-10 hours.
3. Drain the basin, rinse well with fresh water, and wipe dry with a clean paper towel.

SECTION 4: CARE & MAINTENANCE

Troubleshooting

This helpful troubleshooting guide will provide you with information about how to recognize a problem with your product, determine possible causes, and find a solution.

In the event your specific situation is not covered in this guide, please contact Living Earth Crafts so our technical support department can assist you. Beyond the troubleshooting guide below, do not attempt to repair the issue yourself. This can void your warranty.

Unauthorized service will not be covered. Please be sure to contact Living Earth Crafts Customer Service first at (800) 358-8292, (760) 597-2155 Int'l.

Issue	Solution
No Power/Not Operating	<ol style="list-style-type: none">1. Ensure the power cord is properly plugged into an operational GFCI power supply/outlet.2. Check GFCI reset and circuit breakers or fuses.3. Ensure the outlet in your room is receiving power. This can be done by plugging in a small appliance and turning it on.
No Power to Jet/ Jet not Operating	<ol style="list-style-type: none">1. Ensure the power cord is properly plugged into an operational GFCI power supply/outlet.2. Check GFCI reset and circuit breakers or fuses.3. Ensure magnetic rotor/impeller is correctly installed in the case.4. Reset the motors by unplugging the system, waiting 5 seconds, then plugging in again.
Excessive Noise from Jet	<ol style="list-style-type: none">1. Remove jet assembly and inspect for dirt buildup, debris, wear, or damage.2. Follow cleaning instructions or replace if necessary.
Water Leakage	<ol style="list-style-type: none">1. Check and ensure all visible bolts are tightened.2. Call a plumber to determine the source of the leak.3. If the leak is from the jet system, contact LEC customer service.

SECTION 4: CARE & MAINTENANCE

Warranty Information

Living Earth Crafts (LEC) offers an industry best warranty on all pedicure units.

- Motors and controls, actuators, foam and upholstery are warranted for two (2) years, including parts and labor unless otherwise noted.
- Glass parts are warranted for one (1) year.
- Accessories and replacement parts are warranted for ninety (90) days from date of shipment.

Living Earth Crafts may repair or replace defective components at our discretion. Living Earth Crafts will return the warranted product, standard shipping pre-paid, to customers in the continental US. International customers are responsible for any applicable duties and taxes, as well as all shipping charges inbound and outbound.

Excluded from Limited Warranty:

1. Unauthorized repairs.
2. Damage due to freight, accident, natural disaster, and/or abuse.
3. Damage or malfunctions due to improper installation including but not limited to, failure to comply with all national, state, and local plumbing, electrical, and building codes.
4. Fading, discoloration, or staining of any part due to improper water additives, hard water, or harmful cleaning agents or chemicals.
5. Damage to drain pump due to obstruction in drain hose and/or debris in pump impeller housing.

Parts and/or circumstances for which labor is NOT COVERED - Parts noted below are simple to replace and DO NOT require a service technician:

- Jet cover and/or impeller
- Footrest/leg supports
- On/off air actuated button
- Black plastic parts
- Manicure trays
- Replacement upholstery
- Faucet cartridge and/or filler-sprayer
- Relaxor
- Any LED light
- Handheld control wands
- Any international shipment including but not limited to Canada and Mexico

All warranties are limited to repair or replacement, at Living Earth Craft's discretion, unless otherwise stated. This limited warranty applies only to pedicure chairs installed in any one of the fifty (50) States of the United States, the District of Columbia, or provinces of Canada.

SECTION 5: INSTALLATION

Technical Drawings

Water, discharge, and ventilation lines will need to be connected. See technical drawings below showing connection points. A licensed plumber and electrician must make the utility connections to this pedicure chair.

NOTE: INSTALLER/OWNER BEARS ALL RESPONSIBILITIES TO COMPLY WITH ALL STATE AND LOCAL CODES FOR PLUMBING AND ELECTRICAL WHEN INSTALLING THIS PRODUCT. FAILURE TO COMPLY WITH THESE INSTRUCTIONS MAY VOID WARRANTY.

IMPORTANT: Client's ventilation intake needs to pull a minimum 70-75 CFM at the chairs connection point to achieve 50 CFM from open vent.

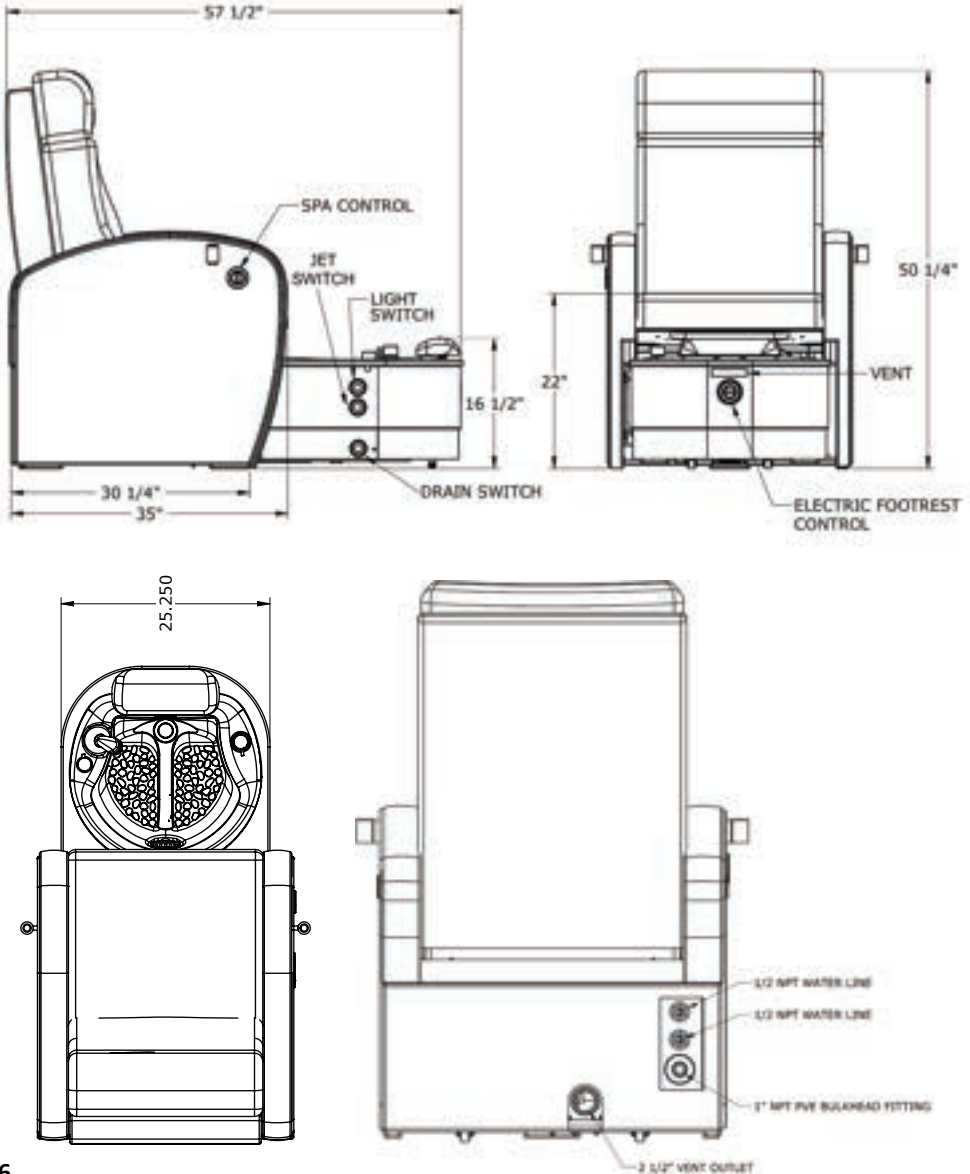

SECTION 5: INSTALLATION

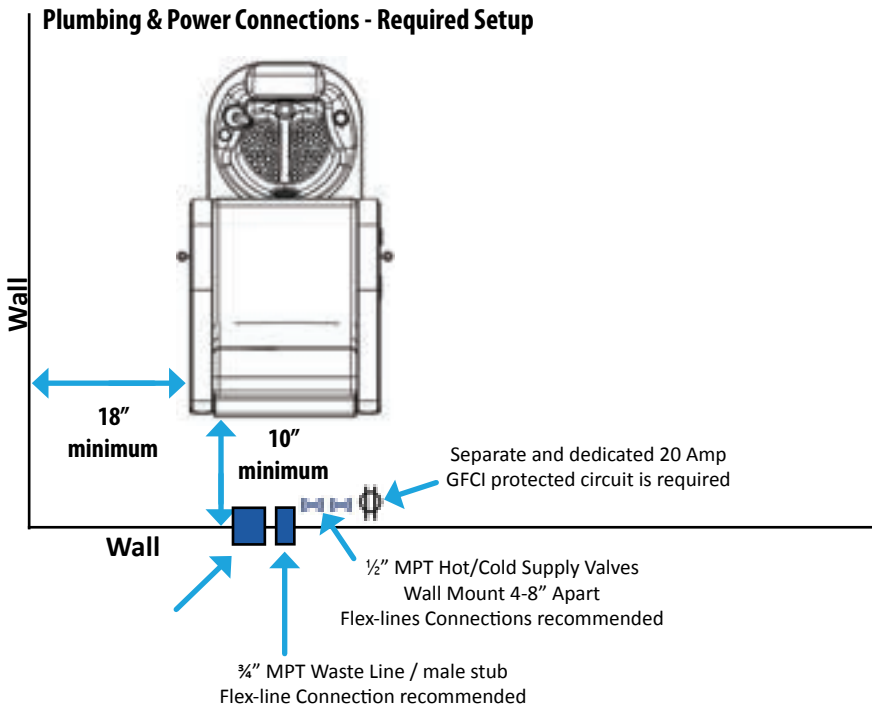
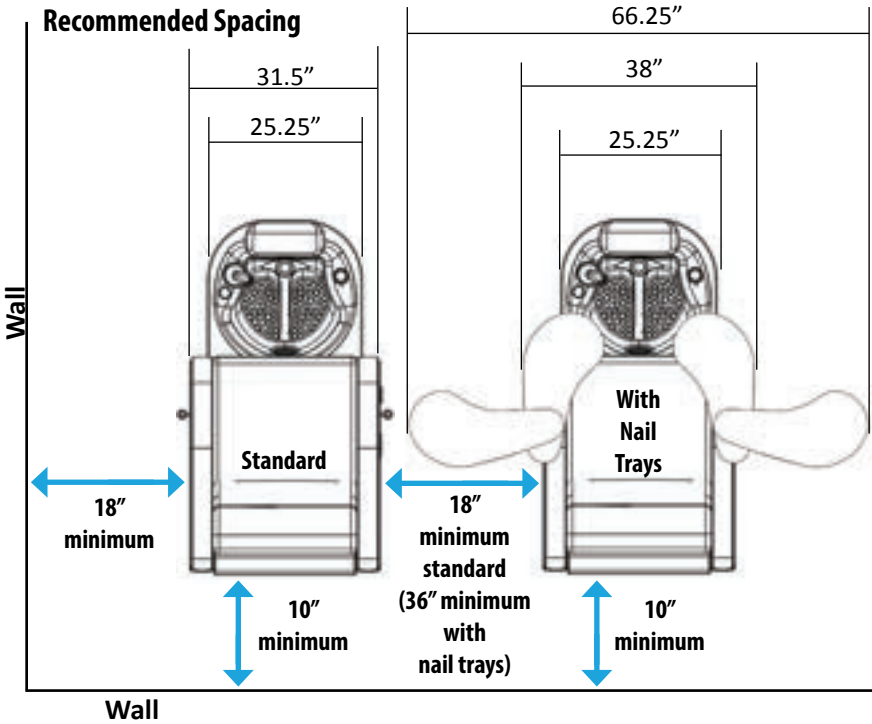

SECTION 3: INSTALLATION

Backflow Prevention (Discharge Line)

Each Contour comes with a swing check valve pre-installed on the discharge line. This valve is NSF certified for potable water use (see detailed specification from manufacturer on the next page). The valve is installed on the discharge line immediately after the discharge pump as shown in the technical diagram below. The placement prevents backflow from the discharge line into the tub.

SWING CHECK VALVE INFORMATION

Ryan Herco (PART #S1520-07F)

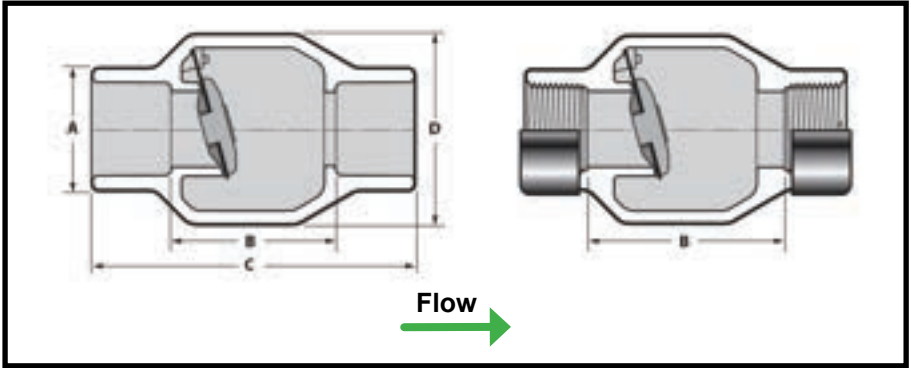

VALVE PLACEMENT

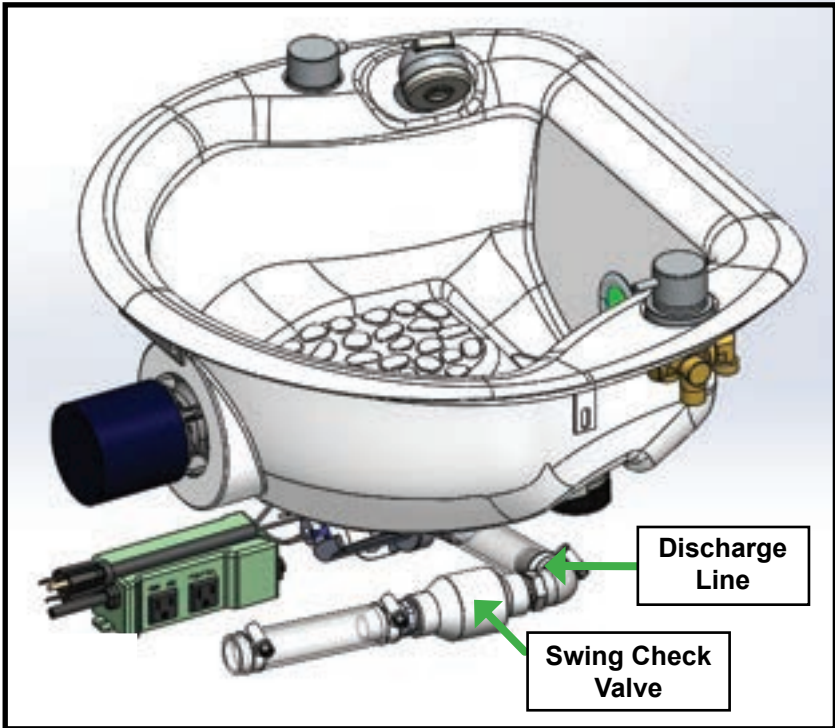

SECTION 3: INSTALLATION

Backflow Prevention (Discharge Line)



Thermoplastic Valves Product Guide & Engineering Specifications Utility Swing & Spring Check Valves



Sample Engineering Specification

All thermoplastic check valves shall be Utility Swing Check or Utility Spring Check type constructed from PVC Type I, ASTM D 1784 Cell Classification 12454. All valves shall be maintenance free seal unit construction with EPDM seat and weighted disc. All Spring Check Valves shall have stainless steel spring assisted operation. All valves shall have external flow arrow direction designation. All valves shall be certified by NSF International for use in potable water service. All valves 1/2" – 4" shall be pressure rated to 150 psi for water @ 73°F in full flow (open) position and to 75 psi @ 73°F back pressure (closed), all valves 6" – 8" shall be pressure rated to 100 psi for water @ 73°F in full flow (open) position and to 50 psi @ 73°F back pressure (closed), as manufactured by Spears® Manufacturing Company.

Quick-View Utility Swing Check Valve Selection Chart

Valve Size	Seal Material	PVC Material ¹			Pressure Rating
		Socket	Threaded	SR Threaded	
1/2	EPDM	S1520-05	S1520-05F	S1520-05FSR	150 psi @ 73°F Full Flow (Open) 75 psi Back Pressure (Closed)
3/4	EPDM	S1520-07	S1520-07F	S1520-07FSR	
1	EPDM	S1520-10	S1520-10F	S1520-10FSR	
1-1/8	EPDM	S1520-12	S1520-12F	S1520-12FSR	
1-1/2	EPDM	S1520-15	S1520-15F	S1520-15FSR	
2	EPDM	S1520-20	S1520-20F	S1520-20FSR	
2-1/2	EPDM	S1520-25	S1520-25F	S1520-25FSR	
3	EPDM	S1520-30	S1520-30F	S1520-30FSR	
4	EPDM	S1520-40	S1520-40F	S1520-40FSR	
6	EPDM	S1520-60	S1520-60F	S1520-60FSR	
8	EPDM	S1520-80	N/A	N/A	

¹ For PVC Clear Spring Check, replace dash (-) separator with the letter "C" in the part number (e.g. S1520C05), (e.g. S1520C05F) or (e.g. S1520C05FSR).

Features - PVC White & PVC Clear

Spears® Utility Swing Check and spring assisted Utility Spring Check Valves offer a compact, high performance check valve for Landscape & Irrigation, Pool & Spa, Aquaculture, OEM and many general purpose applications. These maintenance free sealed units feature long-life EPDM elastomer seats with weighted disc for full-flow with minimal restriction and positive shutoff. Spring assisted "Spring Check" model incorporates a positive-pressure spring to assist in valve closing without slamming. Produced from PVC White or PVC Clear material with Socket, Threaded or SR Threaded end connectors. Available in IPS Sizes 1/2" through 8" for Swing Check Valves and 1/2" through 4" for Spring Check Valves.

- Chemical & Corrosion Resistant PVC White or High Visibility PVC Clear Construction
- No Metal Parts on Swing Check - Stainless Steel Spring on Spring Check
- Maintenance Free Sealed Unit in a Compact Space Saving Design
- Engineered for Maximum Flow, Quick Response & Positive Shutoff
- Long-Life, High Grade EPDM Seat with Weighted Disc
- Spring Assisted Spring Check Model Option for Positive Closing
- Sizes 1/2" – 4" Pressure Rated to 150 psi @ 73°F Full Flow (open) and 75 psi @ 73°F Back Pressure (closed)
- Sizes 6" – 8" Pressure Rated to 100 psi @ 73°F Full Flow (open) and 50 psi @ 73°F Back Pressure (closed)
- Suitable for either Horizontal or Vertical Up-flow Installations and Vacuum Service
- NSF® Certified for Potable Water Use
- Silicone-Free Assembly

Quick-View Utility Spring Check Valve Selection Chart

Valve Size	Seal Material	PVC Material ¹			Pressure Rating
		Socket	Threaded	SR Threaded	
1/2	EPDM	S1580-05	S1580-05F	S1580-05FSR	150 psi @ 73°F Full-Flow (Open)
3/4	EPDM	S1580-07	S1580-07F	S1580-07FSR	
1	EPDM	S1580-10	S1580-10F	S1580-10FSR	
1-1/4	EPDM	S1580-12	S1580-12F	S1580-12FSR	
1-1/2	EPDM	S1580-15	S1580-15F	S1580-15FSR	75 psi Back Pressure (Closed)
2	EPDM	S1580-20	S1580-20F	S1580-20FSR	
2-1/2	EPDM	S1580-25	S1580-25F	S1580-25FSR	
3	EPDM	S1580-30	S1580-30F	S1580-30FSR	
4	EPDM	S1580-40	S1580-40F	S1580-40FSR	

¹ For PVC Clear Spring Check, replace dash (-) separator with the letter "C" in the part number (e.g. S1580C05), (e.g. S1580C05F) or (e.g. S1580C05FSR).



Contact Us

Living Earth Crafts
990 Joshua Way
Vista, CA. 92081
(800) 358-8292
(760) 597-2155 Int'l
(866) 449-8872 fax
info@livingearthcrafts.com

Hours of operation:

Monday - Friday
8:00 a.m. to 5 p.m. PST

Saturday - Sunday
Closed

Visit us online at: livingearthcrafts.com



Join us on
Facebook



Follow us on
Twitter



Follow us on
Instagram



Connect with us
on Linked In