



Wireless Professional
User Manual EN

QUICK START GUIDE

Note

- It is strongly advised to carefully read the contraindications and safety measures described in chapter 1 and 2 in this manual before using your device.
- For detailed information on usage also see Chapters 3 to 14 of this manual.

1. Turn the Remote Control on, by pressing the On/Off button.



2. Upon activation the screen displays a list that gives you access to the categories of programmes.



3. Select a program category and a program within the category by using the navigation pad (up/down)



4. Confirm your choice with the centre button.



5. Stick the electrodes on the patient and connect the modules.

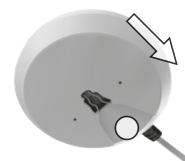

6. Turn on the modules, being careful to respect the order of activation of the modules, the turning-on order corresponds to the channel numbering.

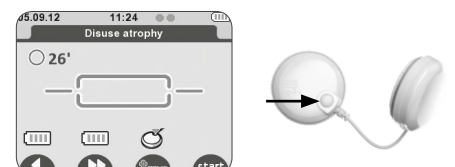

QUICK START GUIDE

7. **Validate everything by pressing the button below the START symbol.**

If the mi-SCAN function is activated, a short sequence of measures is performed. Throughout the duration of the test, it is important to stay still and be perfectly relaxed. When the test is complete, the programme can begin.



8. **Start the stimulation by increasing the energies of the channels.**

To pause the device, press the centre button.

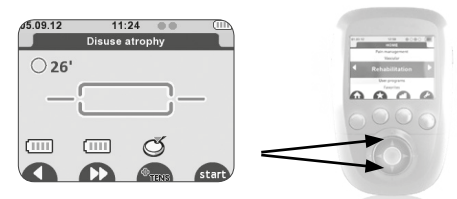

9. **At the end of the programme press the centre button to return to the main menu or press the On/Off button to turn off the device.**



CONTENTS

1. How to Use the Medical Equipment (Intended Use)	7
1.1 Fields of application.....	7
1.2 Therapy objectives.....	7
1.3 Indications.....	8
1.4 Contraindications.....	8
1.5 Secondary effects.....	9
2. Safety Information	10
3. Description of the Wireless Professional	18
3.1 Device components and accessories.....	18
3.2 Explanation of symbols (connections and nameplates).....	20
3.2.1 Symbols on device and AC Power Supply.....	20
3.2.2 Symbols on Charging Tablet/Docking Station and AC Power Supply.....	22
3.3 Description of the device components.....	24
3.3.1 Remote Control.....	24
3.3.2 Modules.....	25
3.4 Description of key accessories.....	26
3.4.1 Smart 4CH docking station and Removeable tablet.....	26
3.4.2 Basic 2 CH docking station.....	27
3.4.3 The Motor Point Pen.....	28
3.5 Description of key Displays shown.....	29
3.5.1 Display in Programme Category selection mode (Home Screen).....	29
3.5.2 Display in Programme selection mode.....	30
3.5.3 Display when programm is selected, Modules need to be turned on, mode.....	31
3.5.4 Display during treatment.....	32
3.5.5 Display during pause in treatment.....	33
3.5.6 Display at the end of a treatment.....	34
4. Device Setup	35
4.1 Smart 4CH Docking station - Connecting the unit, performance check.....	35
4.2 Charging the Remote Control and the Modules.....	36
4.3 Multi-Sessions mode – Synchronisation with few remotes and Smart 4CH Docking station.....	38
4.4 Basic 2CH Docking station - Connecting the unit, performance check.....	39
5. How to Perform a Treatment, Performance Check	40
5.1 Select a Program.....	40
5.2 Adjust treatment options.....	41
5.3 Electrode placement.....	41
5.4 Body positioning of the patient.....	42
5.5 Connecting the modules to the electrodes.....	43
5.6 Starting the treatment.....	44

CONTENTS

5.7 Ending the treatment.....	46
5.8 Performance Check.....	46
6. Treatment Options, Functions and Device Settings.....	47
6.1 How to use the Motor Point Pen.....	47
6.2 Treatment Options – Muscle Intelligence™ Technology.....	49
6.2.1 Selection of the body area.....	49
6.2.2 Energy management.....	50
6.2.3 Triggering of contraction.....	51
6.3 Available Functions.....	53
6.3.1 The Favorite List.....	53
6.3.2 The Lock Out function.....	54
6.3.3 The Synchronisation Signal.....	56
6.3.4 Identify modules.....	57
6.4 Available device Settings.....	58
6.5 WIRELESS PROFESSIONAL SOFTWARE (firmware update remote control, customized programs, patient history).....	60
6.5.1 Firmware update of the Remote Control.....	60
6.5.2 Additional Functions of the SOFTWARE, when having a WIRELESS PROFESSIONAL device.....	61
6.5.2.1 History list.....	62
6.5.2.2 Create a patient's list and monitor their treatment progress.....	63
6.5.2.3 Create customized stimulation programs.....	64
6.5.2.4 Remote Synchronization.....	67
6.5.2.5 Configuration/Settings.....	68
6.5.2.6 Help.....	69
7. Troubleshooting.....	70
7.1 Errors shown on display.....	70
7.2 Behaviour of the Module LEDs.....	73
7.3 Behaviour of the Docking Station LEDs.....	74
7.4 Others.....	75
8. Care, Maintenance, Transport, Environmental Statement.....	78
8.1 Care.....	78
8.2 Maintenance.....	79
8.3 Transport.....	80
8.3.1 Transport of the 4CH device key components and the Tablet (off site treatment).....	80
8.3.2 Shipping the entire 4CH unit (incl. Smart Docking Station).....	81
8.3.3 Transport of the 2CH device key components.....	82
8.3.4 Shipping the entire 2CH unit (incl. Basic Docking Station).....	83
8.4 Environmental Statement, Expected Life.....	84

CONTENTS

9. Technical Data, Standards, Guarantee, Patents.....	85
9.1 Technical Data.....	85
9.1.1 General information.....	85
9.1.2 Neuro-Stimulation Parameters.....	86
9.1.3 RF data.....	86
9.1.4 Information on electromagnetic compatibility (EMC).....	87
9.1.5 Enviromental conditions.....	87
9.2 Standards.....	88
9.3 Guarantee.....	88
9.4 Patents.....	88
10. EMC Tables.....	89
10.1 Electromagnetic emissions.....	89
10.2 Electromagnetic immunity.....	90
10.3 Recommended separation distances.....	92
11. Contact.....	93
12. Electrotherapy Theory.....	94
12.1 Introduction.....	94
12.1.1 The fundamental law of electrostimulation.....	94
12.1.2 Summary.....	98
12.1.3 References.....	99
12.2 The Optimum Current.....	99
12.2.1 Introduction.....	99
12.2.2 Characteristics of the optimal current.....	99
12.2.2.1 Electrical stimulation wave produced by the current generator.....	99
12.2.2.2 Type of establishment of the electrical stimulation wave.....	100
12.2.2.3 Shape of the electrical stimulation wave.....	101
12.2.2.4 Duration of rectangular electrical pulse.....	102
12.2.2.5 Compensation for the rectangular pulse.....	104
12.2.3 Summary.....	105
12.3 Basic concepts of excitation electrophysiology.....	105
12.3.1 Introduction.....	105
12.3.2 Study of the excitation process using a constant current.....	107
12.3.3 Excitation by a current with any shape.....	109
12.3.4 Chronaxy - excitation constant relationship.....	109
12.3.5 Hydraulic model of excitation.....	110
13. Available Therapy Programs.....	112
13.1 Standard Version Programs and their usage.....	112
13.1.1 Program category REHABILITATION I.....	113
13.1.2 Program category PAIN RELIEF.....	122

CONTENTS

13.1.3 Program category VASCULAR	131
13.1.4 CONDITIONING I	139
13.2 Full Version Programs and their usage (Indication Specific Programs)	144
13.2.1 REHABILITATION II	146
13.2.2 AGONIST / ANTAGONIST	160
13.2.3 PROGRAMMES FOR HAEMOPHILIACS	163
13.2.4 NEUROLOGICAL	166
13.2.5 PAIN RELIEF II	174
13.2.6 CONDITIONING II	190
14. How to Use the Wireless Professional on Specific Indications.....	209
14.1 Overview	209
14.2 Disuse atrophy rehabilitation (standard protocol).....	211
14.3 Rehabilitation of the peroneus muscles following an ankle sprain.....	213
14.4 Rehabilitation of low back muscles	216
14.5 Treatment of patellofemoral syndrome.....	219
14.5.1 Lateral tracking	219
14.5.2 Post-traumatic condition.....	222
14.6 ACL ligamentoplasty.....	224
14.7 Rehabilitation of the gluteal muscles following total hip replacement	228
14.8 Rehabilitation of the shoulder.....	230
14.8.1 Rotator cuff tendinopathy.....	231
14.8.2 Shoulder instabilities.....	235
14.8.3 Adhesive capsulitis.....	238
14.8.4 Cardiac Rehabilitation	241
14.9 Reflex sympathetic dystrophy (or Complex regional pain syndrome)	244
14.10 Endorphinic treatment of Rachialgia and Radiculalgia.....	249
14.10.1 Endorphinic treatment of cervical pain.....	251
14.10.2 Endorphinic treatment of thoracic back pain.....	253
14.10.3 Endorphinic treatment of low back pain.....	255
14.10.4 Treatment of lumbosciatic pain.....	258
14.11 Hemiplegia - Spasticity	261
14.11.1 Dorsiflexion of the hemiplegic foot.....	262
14.11.2 Spasticity.....	264
14.11.3 The hemiplegic hand.....	268
14.11.4 The hemiplegic shoulder	270
14.12 Treatment of venous insufficiency.....	273
14.12.1 Venous insufficiency without oedema	273
14.12.2 Venous insufficiency with oedema	275
14.13 Treatment of arterial insufficiency in the lower limbs.....	278
14.13.1 Stage II arterial insufficiency.....	279
14.13.2 Stage III arterial insufficiency	281

1. HOW TO USE THE MEDICAL EQUIPMENT (INTENDED USE)

Note

- This manual is considered as an accessory of the therapy unit and therefore it should accompany it at all times.
- The specific instructions provided given here are conditions for the intended use and correct operation of the equipment as well as the safety of the patient and the operator using it.
- Please read the entire manual carefully and section 2 in particular, since information concerning several chapters is only given once, before using your device!

1.1 Fields of application

The Wireless Professional is a stimulator designed for use by health professionals to ensure electric stimulation treatments in pain management (TENS) as well as for neuro muscular stimulation (EMS/ NMES).

The Wireless Professional physiotherapy unit is an important supplement to medical and therapeutic treatment for use in hospitals, clinics, general practices and at a patient's home by a therapist.

1.2 Therapy objectives

The Wireless Professional is a multifunctional electrotherapy unit for the post surgical and conservative treatment of muscular imbalance as well as pain management.

The following therapy forms are provided by the unit:

- TENS (transcutaneous nerve stimulation) for painmanagement
- NMES (neuromuscular electrical stimulation, also EMS)
- FES (functional electrical stimulation)

1. HOW TO USE THE MEDICAL EQUIPMENT (INTENDED USE)

1.3 Indications

The physiotherapy unit is indicated in the treatment of most musculoskeletal injuries and diseases as well as in postoperative treatment after joint surgeries and in the treatment of several pain indications.

Examples:

As an NMES device, indications are for the following conditions:

- Retarding or preventing disuse atrophy
- Maintaining or increasing range of motion
- Re-educating muscles
- Relaxation of muscle spasms
- Increasing local blood circulation

As a TENS device, indications are for the following conditions:

- Symptomatic relief and management of chronic, intractable pain
- Adjunctive treatment for post-surgical and post-trauma acute pain
- Relief of pain associated with arthritis.

1.4 Contraindications

Do NOT use the Wireless Professional on patients with:

- Implanted electronic devices. Do not use the device if you have a cardiac stimulator, implanted defibrillator or other implanted electronic/electrical device. Epilepsy
- Pregnancy (do not use on abdominal region)
- Serious arterial circulation problems in lower limbs
- Abdominal or inguinal hernia
- Do not use chest stimulation on patients with cardiac arrhythmia
- This could cause an electrical shock, burns, electrical interference or death

Heart disease

If you have suspected or diagnosed cardiopathy you should follow the precautions for use recommended by your doctor.

1. HOW TO USE THE MEDICAL EQUIPMENT (INTENDED USE)

Note

Metalwork and/or prosthesis equipment

The presence of metalwork and/or prosthesis equipment (metallic equipment in contact with the bone: pins, screws, plates, prostheses, etc.) is not a contraindication. The electrical currents of the Wireless Professional are specially designed to have no harmful effect on osteosynthesis equipment.

1.5 Secondary effects

Currently, there is no evidence of desired or undesired secondary effects caused by electrotherapy units.

2. SAFETY INFORMATION

Definitions

It is mandatory to read the safety statements before using the physiotherapy unit. The safety statements are classified as follows:

**Danger!**

This term indicates an imminent hazard. If not avoided, this hazard could result in death or serious injury.

**Warning!**

This term indicates a hazard. If not avoided, this hazard can result in death or serious injury.

**Caution!**

This term indicates a potential hazard. If not avoided, this hazard can result in minor personal injury and/or product/property damage.

Safety information

**Danger!**

Explosion hazard - Wireless Professional is not designed for use in areas where an explosion hazard may occur. An explosion hazard may result from the use of flammable anesthetics, oxygen-rich environments, skin cleansing agents and disinfectants.

2. SAFETY INFORMATION



Warning!

Patient hazard -

- Only authorized individuals are allowed to operate the Wireless Professional. Individuals are authorized after receiving training in the operation of the unit and reading this operating on manual.
- Before using the therapy unit, the operator must ascertain that it is in correct working order and operating condition. The cables and connectors, in particular, must be checked for signs of damage. Damaged parts must be replaced immediately, before use.
- Stop therapy immediately if you have doubts about the device settings and/or the therapy protocol.
- Patients must be fully conscious while being instructed in the use of the therapy unit and during therapy.
- The choice of the therapy parameters to program and of the therapy protocols to use is restricted to the responsible physician or therapist. It is the physician's or therapist's decision whether or not to use the unit on a specific patient.
- The patient must be familiar with the functions of the Wireless Professional remote control with the modules and the remote control must be within easy reach of the patient, allowing them to stop therapy, if needed. Patients unable to operate the emergency stop function (either by stopping on the remote control or by turning of the modules), e.g. paralytic patients, must never be left unattended during therapy.
- Any accessories used with Wireless Professional must first be approved by the manufacturer.
- The utmost caution is advised under the following conditions. Depending on the judgement of the responsible physician, the unit may only be applied under supervision and with the parameters defined by the responsible physician. Otherwise the exercise may be too strenuous for the patients with :
 1. hypertension (> stage 2), ischemic heart disease and cerebrovascular diseases
 2. cardiovascular diseases
 3. pregnancy
 4. under 16 years of age
- Never apply the electrodes:
 - Near the head
 - On the front and side of the neck
 - Counter-laterally, i.e. do not use two poles connected to the same channel on opposite sides of the body.
 - On or near skin lesions of any kind (wounds, swelling, burns, irritation, eczema, cancerous lesion, etc.)
- If the person is pregnant or menstruating do not place electrodes directly on the uterus area or connect pairs of electrodes on either side of the abdomen to avoid any risk for the mother and/or the baby.

2. SAFETY INFORMATION



- Never allow muscular contraction during a stimulation session to result in movement. You should always stimulate isometrically; this means that the extremities of the limb in which a muscle is being stimulated must be firmly fixed, so as to prevent any movement that results from contraction.



Warning!

- Extreme caution should be taken when in use around small children and babies! Sufficient distance to the device and its accessories is mandatory for their safety!
- Never leave the device unattended when it is switched on! Switch the device off and disconnect the electrodes from the modules!
- After use, store the device in a safe place to avoid other people not informed to use the device!
- This device is not a toy but a medical device where misunderstanding or misuse can cause damage!



Warning!

Shock hazard - Strictly observe the following warnings. Failure to do so could endanger the lives of the patient, the user and other persons involved.

- **Before use** allow the **Wireless Professional** to reach room temperature. If the unit has been transported at temperatures below 0 °C (32°F), leave it to reach at room temperature for about 2 hours, until any condensation has disappeared.
- **Electrosurgical equipment or defibrillators.** Disconnect the electrodes from the device before using electrosurgical equipment, or a defibrillator, to avoid cutaneous burns from the electrodes and destroying the device.
- **Electronic surveillance equipment.** Do not apply stimulation near electronic surveillance equipment (e.g. cardiac monitors, ECG alarms), as there is a risk they may not work properly whilst the electrical stimulation device is being used.
- **Electromagnetic radiation.** Do not use the stimulator in areas in which unprotected devices are used to emit electromagnetic radiation. Portable communications equipment can interfere with the device.
- **Cancer.** Do not apply stimulation if you have progressive cancer or near any cancerous tumour. The increased metabolism, caused by certain modes of stimulation, is likely to encourage cancer cells to spread

2. SAFETY INFORMATION

- **Muscle shortening.** During the muscular contraction phase it is recommended to hold the extremities of the stimulated limbs to avoid any shortening of the muscle during contraction, which could cause cramps.
- **Contralateral stimulation.** Do not use two terminals connected to the same channel on opposite segments of the body (for example, a positive terminal on the left arm and a negative terminal on the right arm).
- **Loss of sensation.** Proceed with caution if stimulation is applied to areas of the skin where the level of sensation is lower than normal. Do not apply stimulation to a person who cannot express themselves.
- **Battery leakage.** If there is leak from a component, take steps to ensure the liquid does not come into contact with skin or eyes. Should this occur, wash the affected area with water and consult a doctor.
- **Strangulation.** Do not wind cables around the neck. Tangled cables can cause strangulation.
- **Post-surgery.** Proceed with caution after recent surgery.
- **Accessibility of the power adaptor.** The plug socket must be close to the power adaptor and be easily accessible.
- **Internal bleeding.** Proceed with caution if you are prone to internal bleeding; for example, after an injury or a fracture.

The Wireless Professional must only be operated in dry rooms.

- **Do not use** the Wireless Professional **in water or in a humid atmosphere** (sauna, Bath, Shower etc.) that would cause electronic failure.
- **Water protection.** The unit is not protected from the ingress of water
- When connecting the unit to other equipment or when creating a medical system, check that the sum of leakage currents will not cause any hazard. Please contact DJO GLOBAL if you have questions regarding this matter.
- No modification of this equipment is allowed.
- Do not open the product and its accessories as there is risk of electrocution

- Before cleaning and service interventions, turn the remote control and the modules off and disconnect the tablet from the power line by removing the power cord from the wall outlet.
- Liquids and foreign material (such as dust, metal etc.) must not be allowed to enter the remote control, the modules, the charging tablet or the power supply. If such material has entered into the units, it must be immediately checked by a service technician, before it can be reused.
- Electricity supply. Never connect the stimulation cables to an external power supply, as there is a risk of electrocution

2. SAFETY INFORMATION

- Do not apply stimulation near the area of an implant, such as cochlear implants, pacemakers, skeletal anchorage or electric implants. This could cause an electrical shock, burns, electrical interference or death
- Never use the Wireless Professional or the AC adaptor if it is damaged or open. There is a risk of electric shock.
- Disconnect the AC adaptor immediately if there is abnormal heating or smell, or if smoke comes from the AC adaptor or the device.
- Do not place the docking station in a confined space (carrying case, drawer etc.) when charging the device. There is a risk of electrocution.



Warning!

Equipment malfunction - these warnings can cause equipment malfunctions that result in patient hazards

- Magnetic and electrical fields are capable of interfering with the proper performance of the unit. For this reason make sure that all external devices operated in the vicinity of the unit comply with the relevant EMC requirements. X-ray equipment, MRI devices, radio systems and cell phones are possible sources of interference as they may emit higher levels of electromagnetic radiation.
Keep the unit away from such equipment and verify its performance before use.
- Do not use the Wireless Professional within one metre of short wave or microwave devices as this could alter the currents generated by the stimulator. If you are in any doubt as to the use of the stimulator in close proximity to another medical device, seek advice from the manufacturer of the latter or from your doctor.
- Exercise caution when using electrotherapy while the patient is connected to monitoring equipment with electrodes attached to the body. Stimulation could disrupt the signals sent to the monitoring equipment.
- Refer **repair** and **maintenance** to authorised persons. Persons are authorized after training by a specialist trained and commissioned by the manufacturer.
- Inspect the **Wireless Professional** and its accessories for damage and loose connections at least **once a year**. Damaged and worn parts must be immediately replaced with original spare parts by authorised staff.

2. SAFETY INFORMATION



Caution!

Patient hazard - these cautions need to be observed to avoid the risk of electrical shock or other negative effects to the patient.

- Do not apply stimulation close to metal. Remove jewellery, piercings, belt buckles or any other metallic product or device in the area of stimulation.
- Be careful if the patient has sensitivity problems or is not able to communicate that he or she feels discomfort, however light.
- Never begin an initial stimulation session on a person who is standing. The first five minutes of stimulation must always be performed on a person who is sitting or lying down. In rare instances, people of a nervous disposition may experience a vasovagal reaction. This is of psychological origin and is connected with a fear of the muscle stimulation as well as surprise at seeing one of their muscles contract without having intentionally contracted it themselves. A vasovagal reaction causes heart to slow down and blood pressure to drop, which produces a feeling weakness and a tendency towards fainting. If this does occur, all that is required is to stop the stimulation and for the person to lie down with the legs raised until the feeling of weakness disappears (5 to 10 minutes)
- Never allow muscular contraction during a stimulation session to result in movement. You should always stimulate isometrically; this means that the extremities of the limb in which a muscle is being stimulated must be firmly fixed, so as to prevent any movement that results from contraction.
- Do not disconnect any module that is switched on during the stimulation session. They must be switched off first.
- Do not use the stimulator while driving or operating machinery.
- Do not apply stimulation during sleep.
- Do not use the stimulator at altitudes of over 3,000 meters.
- Always turn off the stimulator before moving or removing any electrodes during a session, to avoid electrical shock to the patient.
- Do not try to place electrodes on a body part not directly visible without assistance.
- Attach the electrodes in such a way that their entire surface is in contact with the skin.
- For obvious reasons of hygiene, each patient must have their own set of electrodes. Do not use the same electrodes on different patients.
- Some patients with very sensitive skin may experience redness under the electrodes after a session. Generally, this redness is completely harmless and usually disappears after 10 to 20 minutes. Never start another stimulation session in the same area, however, if the redness is still visible.
- Before each use clean and disinfect the motor point pen tip that is in contact with the skin.
- When using the WIRELESS PROFESSIONAL SOFTWARE to customize programs, take special care that the parameters customised and applied by you to the patient are as you wanted them to be (program architecture shown on screen before treatment starts).

2. SAFETY INFORMATION



Caution!

Equipment damage -

- **Do not let the modules get in contact with massage oils or any other products of the same type that could damaged the device or its accessories.**
- Check that the voltage and frequency ratings of your local **power line** are those indicated on the type plate of the power supply.
- Do not expose the **Wireless Professional** to direct sunlight, because some of the components may reach unacceptably high temperatures.
- The presence of children, and pets does not normally affect the proper functioning. However, Keep pets and children away from the product. Also, keep the unit clean and protect it from dust and lint. The safety rules and regulations set forth apply in any case.
- It is recommended to use the transport bag that comes with the unit, for transport of the device, and to use a proper transport box to ship it.
- Always use the AC adaptor (power supply) provided by the manufacturer to recharge the unit.
- Do not store the modules and remote control for a long time with empty batteries.
- Only use electrodes and motor point pen supplied by the manufacturer. Other electrodes and motor point pens may have electrical properties that are unsuitable for or may damage the Wireless Professional.
- **Size of electrodes.** Do not use electrodes with an active area of less than 16 cm² due to the risk of associated burning. Proceed systematically with caution when the density of the current is over 2 mA/cm².
- Do not place the electrodes or pen in water.
- Do not apply solvents of any kind to the electrodes or pen.
- **Skin irritation.** Some people, with very sensitive skin, may experience redness under the electrodes after a session. Generally, this redness is totally harmless and usually disappears after 10 to 20 minutes. However, never start another stimulation session on the same area if the redness is still visible
- **Instructions for electrodes.** See the usage and storage instructions displayed on the bag of electrodes

2. SAFETY INFORMATION

Note

- For best results, wash and clean the skin of any oil and dry it before attaching the electrodes.
- Never use a set of adhesive electrodes for more than 15 sessions as the quality of the contact between the electrode and the skin, which is essential for the patient's comfort and the effectiveness of the stimulation, gradually deteriorates.
- For information on use and storage please consult the instructions found on the electrodes packaging.

Note

Biocompatibility

Those parts of the Wireless Professional unit that come into contact with the patient when used as intended, are designed to fulfil the biocompatibility requirements of the applicable standards.

3. DESCRIPTION OF THE WIRELESS PROFESSIONAL

3.1 Device components and accessories

Model: Wireless Professional 4CH

Part number: 2532xxx

Your kit contains (included in delivery):

QUANTITY	DESCRIPTION	PART NUMBER
2	remote control	00113x
4	stimulation modules	984350
1	smart 4 CH docking station	6831xx
1	AC adaptor	6490xx
1	USB cable	601163
2	Bags of small electrodes (5x5 cm 1 snap connection)	42204
2	2 bags of large electrodes (5x10 cm 1 snap connection)	42223
2	2 bags of large electrodes (5x10 cm 2 snap connections)	42203
1	user manual and practical guide on on CD/USB	46262xx
1	quick start guide/warning leaflet	885932
1	bottle of gel	602047
1	motor point pen	980020
1	carrying case	680041
2	lanyards	1494
1	white protection sleeve	5529024
1	blue protection sleeve	5528535
1	Set of colored module clips	5529220

3. DESCRIPTION OF THE WIRELESS PROFESSIONAL

Model: Wireless Professional 2CH

Part number: 25326xx











Your kit contains (included in delivery):

QUANTITY	DESCRIPTION	PART NUMBER
1	remote control	00113x
2	stimulation modules	984350
1	Basic 2 CH docking station	101091
1	AC adaptor	108x
1	USB cable	601163
1	Bag of small electrodes (5x5 cm 1 snap connection)	42204
1	1 bag of large electrodes (5x10 cm 1 snap connection)	42223
1	1 bag of large electrodes (5x10 cm 2 snap connections)	42203
1	user manual and practical guide on on CD/USB	46262xx
1	quick start guide/warning leaflet	885932
1	bottle of gel	602047
1	motor point pen	980020
1	transportation pouch	680085
1	lanyard	1494
1	white protection sleeve	5529024
1	Set of colored module clips	5529220



3. DESCRIPTION OF THE WIRELESS PROFESSIONAL

3.2 Explanation of symbols (connections and nameplates)

3.2.1 Symbols on device and AC Power Supply













	Read the user manual or operating instructions
	Caution! Observe warnings set forth in operation manual!
	The Wireless Professional is a class II device with internal electric power and type BF applied parts.
	The power switch On/OFF button is a multi-function button.
	The name and address next to this factory symbol is the manufacturer. The date is the manufacturing date.
	The number next to this symbol is the article reference number
	Device complies with Council Directive 93/42/EEC as amended, concerning medical devices.
	The number next to this symbol is the serial number
	WEEE Mark (European Directive 2002/96/EC). Indicates separate treatment from general waste at end of life.
	Keep dry
IP20 IP02	IP classification indicates the degree of protection and thus defines its suitability for use under various ambient conditions.
	IP 20 on the unit means the protection is effective against ingress of foreign solid objects (diameter greater than 12.5 mm) IP02 on the carrying case means the device is protected against ingress of water (when tilted up to 15°)

3. DESCRIPTION OF THE WIRELESS PROFESSIONAL



	Non-ionising radiation
	Not made with natural latex rubber
	Keep away from direct sunlight

3. DESCRIPTION OF THE WIRELESS PROFESSIONAL

3.2.2 Symbols on Charging Tablet/Docking Station and AC Power Supply

	Alternating current input on AC power supply
	Direct current output from power supply
	Protection class II equipment. The AC Power Supply device has double insulation.
	The Wireless Professional is a class II device with internal electric power and type BF applied parts.
	The name and address next to this factory symbol is the manufacturer. The date is the manufacturing date.
	The number next to this symbol is the article reference number
	Device complies with Council Directive 93/42/EEC as amended, concerning medical devices.
	Read the user manual or operating instructions
	Caution! Observe warnings set forth in operation manual!
	The number next to this symbol is the serial number
	WEEE Mark (European Directive 2002/96/EC). Indicates separate treatment from general waste at end of life.
	Keep dry
	Keep away from direct sunlight

3. DESCRIPTION OF THE WIRELESS PROFESSIONAL

	Indoor use only
	The Geprüfte Sicherheit ("Tested Safety") or GS mark indicates that the equipment meets German and, if available, European safety requirement for electrical devices. Here, approved by TÜV.

3. DESCRIPTION OF THE WIRELESS PROFESSIONAL

3.3 Description of the device components

3.3.1 Remote Control

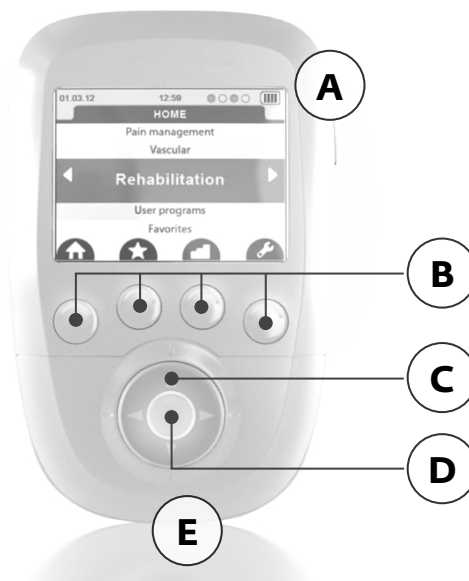

A On/Off button (press briefly to switch on, press and hold for more than 2 seconds to switch off, while browsing the lists press briefly to return to the main menu)

B 4 multifunction buttons:

- Functions related to icons are located on the screen (e.g.: info, main menu, placement of electrodes, etc.)
- Selection of stimulation channel to increase or decrease the energy level of stimulation

C Navigation pad

D Validation or pause button during stimulation

E Port for the USB cable or the docking station connector

Note

Emergency stop function: By pressing the central button or the On/Off button on one of the modules during stimulation, the device pauses.

3. DESCRIPTION OF THE WIRELESS PROFESSIONAL

3.3.2 Modules

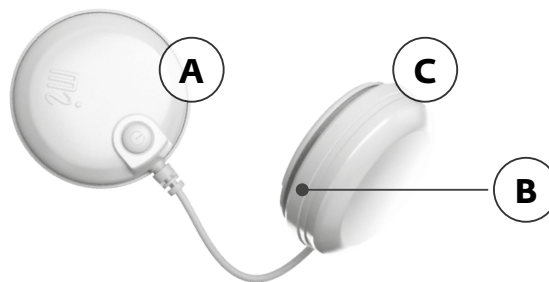

A module is composed of two pods.

A On/Off button (press briefly to switch on, press for 1 second to switch off, during stimulation press to pause)

- Flashing green LED: ready
- Flashing yellow LED: stimulation on

B Groove to wind up the cable

C Pod containing battery

Note

- When the distance among the remote control and the modules is too big, they will lose the connection, stop with the stimulation immediately and the LEDs will flash red and green.
- **Emergency stop function:** By pressing the central button or the On/Off button on one of the modules during stimulation, the device pauses.

3. DESCRIPTION OF THE WIRELESS PROFESSIONAL

3.4 Description of key accessories

3.4.1 Smart 4CH docking station and Removeable tablet

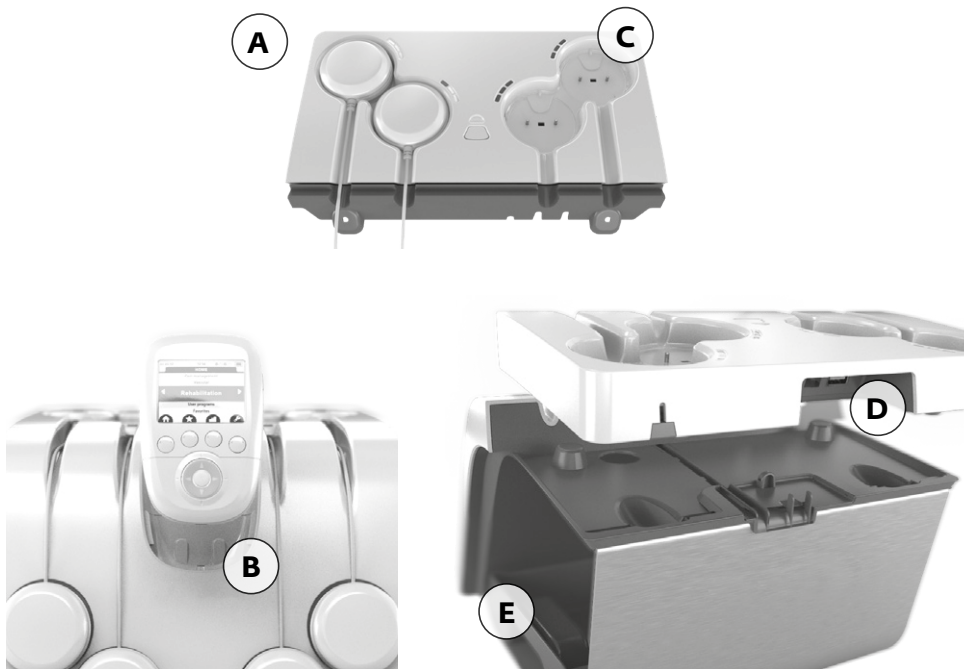

A Removable tablet

B Connector to charge the remote control

C Docking bay to position the modules to be recharged

D Port for the AC adapter and for the USB cable connected to the front of the docking station

E Storage bin

3. DESCRIPTION OF THE WIRELESS PROFESSIONAL

3.4.2 Basic 2 CH docking station

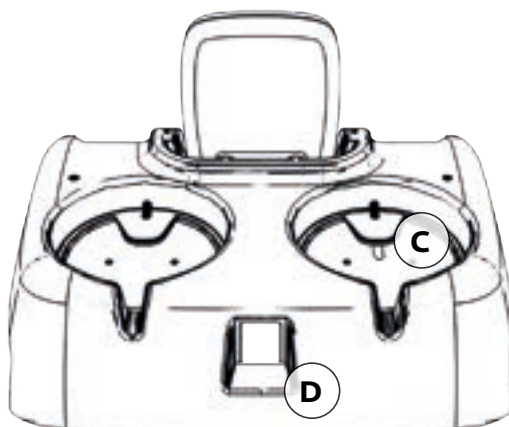
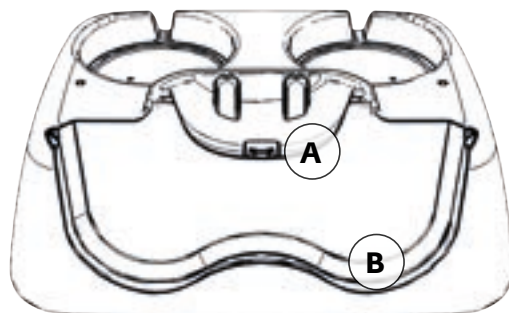

- A Remote control charging connector
- B Location for positioning the modules
- C Location for positioning the modules to be recharged
- D Charger plug

3. DESCRIPTION OF THE WIRELESS PROFESSIONAL

3.4.3 The Motor Point Pen



A Tip of the motor point pen, to locate the motor point

B Snap connection for the positive pod of the module (pod with illuminated button)

Note

- For detailed information on the usage of the motor point pen please see Rev. 6.1
- Always use the conductive gel that comes with the product with the motor point pen.

3. DESCRIPTION OF THE WIRELESS PROFESSIONAL

3.5 Description of key Displays shown

3.5.1 Display in Programme Category selection mode (Home Screen)



A Header showing date, time and battery status

B Current chosen program category (marked with a blue focus, displayed bigger)

3. DESCRIPTION OF THE WIRELESS PROFESSIONAL

3.5.2 Display in Programme selection mode

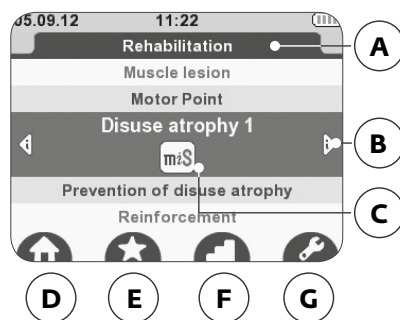

- A Name of the programme category
- B Additional programme information
- C Visualisation of programme options
- D Back to main menu
- E Adding programme to Favourites list
- F Selection of programme level
- G Configuration of programme options

Note

- For the visualisation of the program information (B), please use the left/right direction of the navigation pad, and scroll within the information by using the up/down direction of the navigation pad.
- To add a program to the Favourite list (E), please press the multifunction button below the icon while program is marked. Press the button again to remove the program from the Favourite list.
- If different program levels are available, icon "F" will be displayed. To change the program levels, please press the button below the icon. Up to 3 different levels might be available. From level to level different parameters (e.g. frequency, pause duration etc.) are changing to make the treatment more challenging according to the process in rehabilitation (level 1 for beginners, level 3 for trained persons).
- If programme options are available icon "G" will be displayed. Please press the button below the icon to enter the program option setting screen

3. DESCRIPTION OF THE WIRELESS PROFESSIONAL

3.5.3 Display when programm is selected, Modules need to be turned on, mode

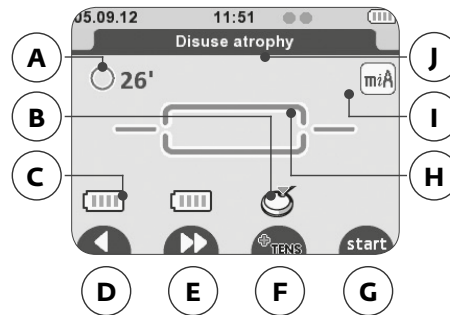

A Total programme time (minutes)

B **Module activation** indication

C Module battery level

D **Back** to previous menu

E Skip function allows you to jump programme sequences (if available) or Programme time increase function (if available)

F +TENS function (if available)

G **Start** Session

H Programme architecture

- 3-sequence programme: Warm-up, Work, Relaxation
- Programme with 1 continuous sequence

I Active option in the programme

J Programme name

Note

- "B" the device asks you to activate the next module. 1 module needs to be activated at least (1-channel treatment). After activating the number of channels required for the treatment (1 up to 4) press start to start the treatment.
- "E" functions are not available within all programs, symbols will only be displayed in programs available
- "F" the "+TENS" function allows you to combine a TENS programme with a selected basic programme. The function will be displayed for the channels if available. (see as well ...)
- "H" the different program architectures are:

- 3-sequences program:

- a) Warm-up
- b) Work
- c) Relaxation

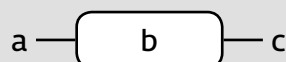

- 1-sequence program, a) continuous work a

3. DESCRIPTION OF THE WIRELESS PROFESSIONAL

3.5.4 Display during treatment

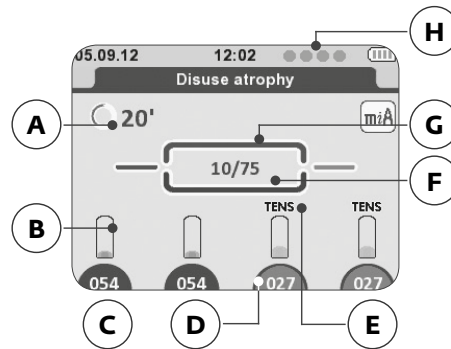

A Total remaining programme time (min)

B Energy level bar graph for each channel

C Energy level for each channel

D Intensity background is:

Dark background = active channel

Bright background = inactive channel

E Indication relating to the channel:

- TENS: channel providing a TENS current
- I-II: channel group

F Number of contractions remaining / total number of contractions

G Indicator of programme execution

H Number and order of attached channels. Circle = channel recognised but module turned off.

Note

“D” intensity control

- Channels can be selected/de-selected by pressing the corresponding button below.
- To change intensity during treatment, channel needs to be selected (dark blue background).
- While channel is not selected (light blue background) stimulation will be performed with the set intensity.
- This function allows you to change the intensity for each channel itself or more than 1 at the same time (by marking the designated channels).

3. DESCRIPTION OF THE WIRELESS PROFESSIONAL

3.5.5 Display during pause in treatment

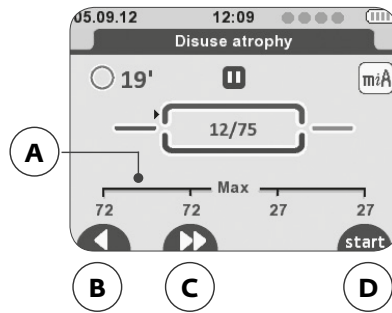

- A Maximum energy level achieved by the channel during contraction phases
- B Back to previous menu
- C Skip function allows you to skip programme sequences (not available for all programmes)
- D Resumes the stimulation session

Note

Emergency stop function: By pressing the central button or the On/Off button on one of the modules during stimulation, the device pauses.

3. DESCRIPTION OF THE WIRELESS PROFESSIONAL

3.5.6 Display at the end of a treatment

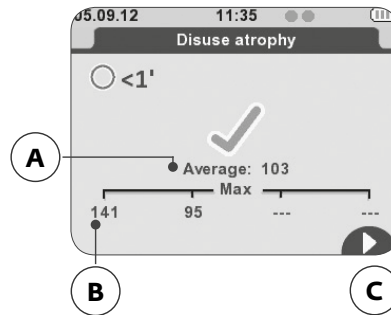

- A** Average energy level of all the channels used during the contraction phase
- B** Maximum energy level achieved by the channel during contraction phases
- C** Back to main menu (HOME). For programs using the mi-range feature the percentage of time spent above the minimum threshold is displayed.

Note

- For programs using the mi-range feature the percentage of time spent above the minimum threshold will be displayed as well.
- To turn the unit off, press the On/Off button on the remote control for more than 2 seconds. This will switch off as well all modules.

4. DEVICE SETUP

4.1 Smart 4CH Docking station - Connecting the unit, performance check

Connect the AC adapter supplied with your device to the removable tablet of the docking station (B) and plug it into a power socket. Also connect the docking station's USB cable to the removable tablet (C).

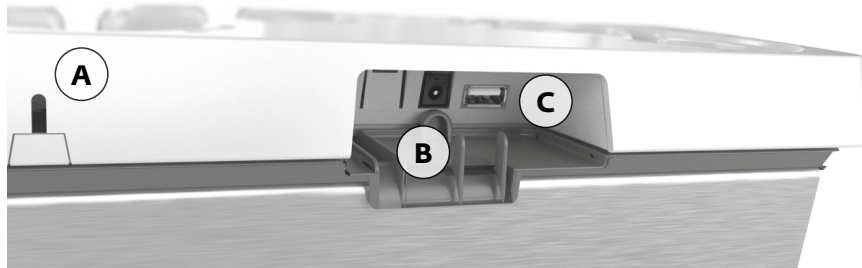

A Rear view of the docking station

B Connector for the AC adapter

C Connector for the USB cable

Note

- It is highly recommended to fully charge the batteries of the remote control and modules before first use to improve their performance and life span.

4. DEVICE SETUP

4.2 Charging the Remote Control and the Modules

Charge the Remote Control by plugging it into the Docking Station. Take care that the USB connector is plugged into the Remote Control.

Note

- The Remote Control can be charged by using the USB connector connected with the tablet allowing it to charge modules and remote at same time. Remote control can also be directly connected to a computer by using USB connector.



Charge the Modules:

Place the modules into the slots provided for this purpose.

To do this place the pod without the On / Off button in the location indicated with the dotted line.

Do the same for the other modules.

Once the modules are placed for charging, their battery level is shown by the blue LEDs of the docking station.



4. DEVICE SETUP

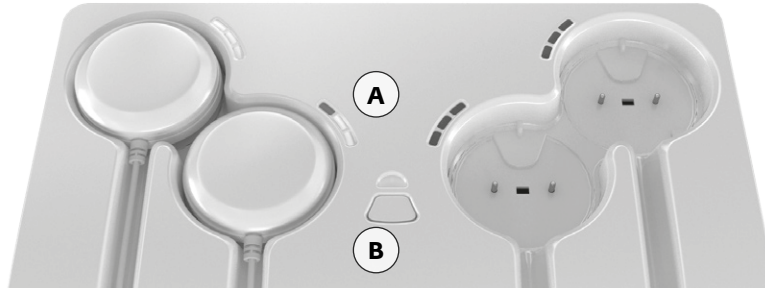

- A** First LED blinking = low battery
 Second LED blinking = battery level average, a session can be performed
 Third LED blinking = good battery level
 All LEDs are lit and not blinking any more = battery completely full

B The LED above the button indicates that the tablet is connected to the power supply. It lights:

Blue = modules can be charged

Red = right after connecting to the power supply during self test

The button allows synchronizing modules and remote control, which is usually done automatically by the unit.

Battery level

In the screen "Modules need to be turned on", the module battery level is displayed on the corresponding channel at the remote control, when you turn the module on, just before starting the stimulation session.

The battery level of the remote control is always visible in the upper right corner.

Small green indicators show how many modules are turned on and recognised by the remote control.

The batteries of the remote control and the modules are designed to stand at least 3 days with 5 treatments per day.

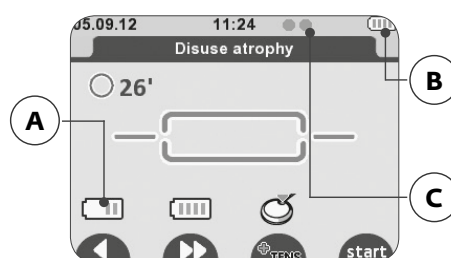

A Module battery level

B Remote control battery level

C Number of modules switched on and recognised by the remote control

4. DEVICE SETUP

4.3 Multi-Sessions mode – Synchronisation with few remotes and Smart 4CH Docking station

Smart 4CH Docking station is able to synchronise any Wireless Professional module(s) and remote(s) plugged on it. Modules plugged on the station will be automatically synchronized and recognized by the remote plugged as well on the station. The B button described in 4.2 Chapter allows synchronizing Modules and Remote control which is usually done automatically by the unit.

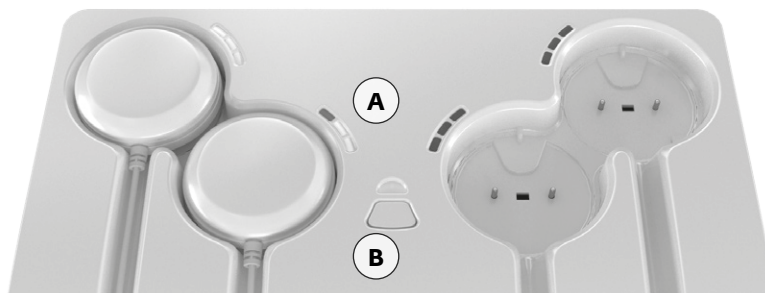

If you are using 2 or more remotes with the same docking station, you will be able to manage separately 2 or more sessions at the same time. Remotes and respective synchronized modules are under separate control until the next synchronization. Sessions can be started independently.

First, plug the number of module(s) necessary for Session 1 (1, 2 or 3 modules) plus the first remote to be synchronized.

After plugging off modules and remote in use for session 1, plug the remaining modules and the second remote to be synchronized for Session 2.

Same process is applicable for several remotes.

Note: 2 kinds of sleeve protection (white and blue) are delivered with the 4CH devices to allow recognition between remotes.

4. DEVICE SETUP

4.4 Basic 2CH Docking station - Connecting the unit, performance check

Connect the AC adapter supplied with your device to the docking station and then plug it into a power outlet. It is strongly recommended that you fully charge the remote control batteries and modules before first use in order to improve its performance and life expectancy.

Charge the Remote Control by plugging it into the Docking Station. Take care that the USB connector is plugged into the Remote Control.

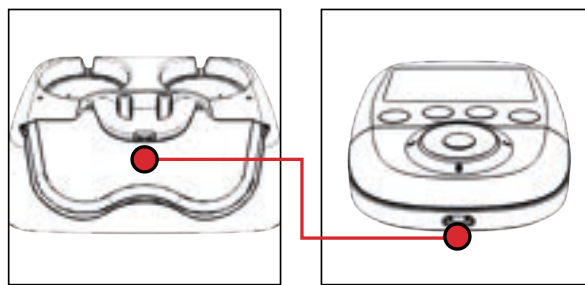

Note

The Remote Control can be charged as well by using the USB connector, which comes with your kit and connect it with the tablet and remote control to charge modules and remote at same time or by connecting the remote control to a computer.

Charge the Modules:

Place the modules into the slots provided for this purpose.

To do this place the module without the On / Off button in the location indicated with the dotted line. Do the same for the other module.

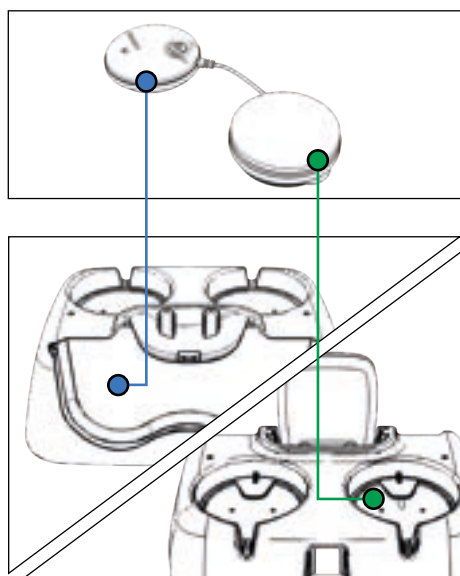

5. HOW TO PERFORM A TREATMENT, PERFORMANCE CHECK

See also Chapter "Description of the Wireless Professional"

1. Turn the Remote Control on, by pressing the On/Off button.
2. Upon activation the screen displays a list that gives you access to the categories of programmes.
3. Select a program category by using the navigation pad (up/down)
4. Confirm your choice with the centre button.

Note

- When you turn on the remote control the first time, the language set up will be displayed first. Chose your preferred language and press the center button to proceed.
- Once you have created your list of favourite programmes, it will be displayed first after switching on the remote control.

5.1 Select a Program

After selecting a programme category the available programs within this category will be displayed. To select a program, use the navigation pad (up/down) and confirm your choice with the centre button.

Note

- Additional information about the programmes, such as electrode placement, program parameters and program explanation, is available.
- Use the navigation pad (left/right) to display them and to scroll (up/down) within an explanation for getting more information.
- You can find the program information as well within this manual.

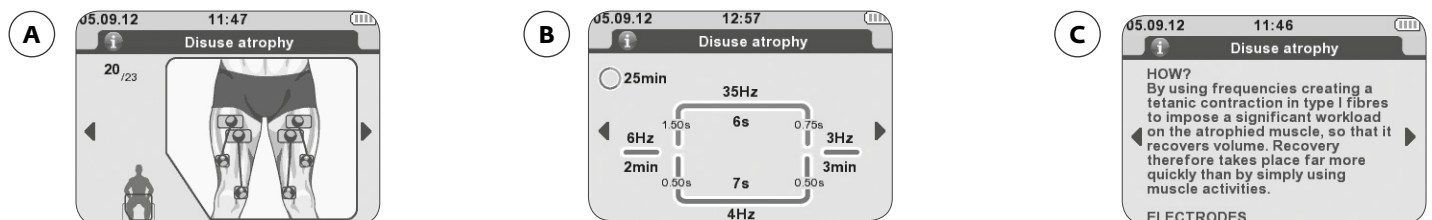

A Placement of electrodes applicable to the programme

B Programme parameters



C Programme explanation

5. HOW TO PERFORM A TREATMENT, PERFORMANCE CHECK

5.2 Adjust treatment options

For most programmes, different options can be enabled or disabled.

For detailed descriptions of the options available see: Chapter "Treatment Options"

1. Press the program options button  to enter the options menu.
2. To mark an item, use the navigation pad (up/down).
3. To change settings of the marked option, use the central button.
4. To store the changed settings press the confirmation button .

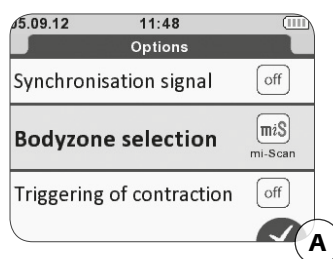

A Confirm / store program option settings

5.3 Electrode placement

The placement of the electrodes belongs to the indication that is supposed to be treated.

Please find detailed recommendations regarding the electrode placement:

- within usage of the Motor Point Pen
- within specific indications
- within your Wireless Professional

Depending on the characteristics of the current used for each programme, the electrode connected to the positive pole (pod with illuminated button) may benefit from a "prime" location that is likely to increase the efficacy of the treatment.

This is the case particularly for muscular electrostimulation programmes requiring strong muscular contractions, for which it is recommended that the electrode with positive polarity is placed on the motor point of the muscle.

The choice of electrode size (large or small) and the correct positioning of the electrodes on the muscle group that needs to be stimulated are determining factors and are essential for stimulation to be effective. As a result, always use the size of the electrodes shown on the images. Unless advised otherwise by a doctor, always follow the positions specified on the images.

5. HOW TO PERFORM A TREATMENT, PERFORMANCE CHECK

5.4 Body positioning of the patient

To determine the stimulation position to be used based on the position of the electrodes and the programme chosen, please refer to the images of where the electrodes are positioned.

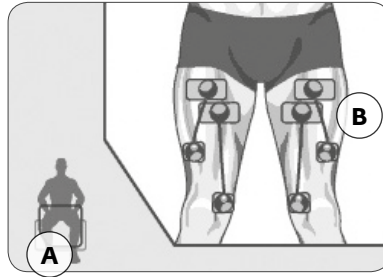

A Body position

B Positioning of the electrodes

The position of the person to be stimulated depends on the muscle group that requires stimulation and on the programme chosen.

For programmes requiring muscle contractions (tetanic contractions), working the muscle isometrically is always recommended to prevent cramps and muscle soreness after the session. For example, when the quadriceps are stimulated, the patient will be placed in a seated position with the ankles fixed with straps to prevent the knees extending. For other types of programmes (for example, analgesic programmes), which do not cause muscle contractions, position the patient as comfortably as possible.

5. HOW TO PERFORM A TREATMENT, PERFORMANCE CHECK

5.5 Connecting the modules to the electrodes

Once the electrodes are stuck to the skin of the patient, fix the pods by sliding them onto the electrode snap until it clicks into place.

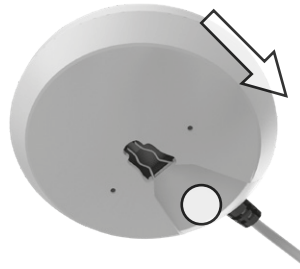

Note

The insertion direction marked by:

- the On/Off button on the main pod
- a small vertical line on the housing of the other pod.

To remove the modules from the electrode simply make the opposite movement.

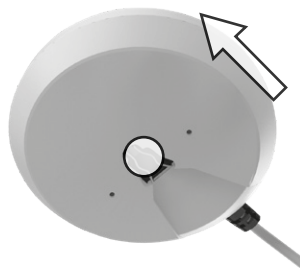

Caution!

Equipment damage -

Pulling the pods without respecting their pulling direction can damage the attachment system.

A stimulation module consists of two poles:

- A positive pole (+) = the pod with an illuminated button
- A negative pole (-) = the other pod of the module

A separate electrode must be connected to each of the two pods.

5. HOW TO PERFORM A TREATMENT, PERFORMANCE CHECK

5.6 Starting the treatment

Before starting the stimulation, the remote control asks you to turn on the modules, one after the other, by pressing their button On/Off.

For each module detected by the remote control, the device will prompt you to switch on another, up to a maximum of 4 modules.

If you want to use a limited number of modules for your session, press the START button after the number of modules you want has been detected.

After activating the modules, press START to start with the therapy:

- Stimulation always starts at intensity level 0.
- Select a channel to change the intensity by pressing the corresponding button.
- The channel will be marked dark blue.
- Use the navigation pad (up-down) to increase or decrease the stimulation energy (intensity) on selected channels.
- None selected channels will remain on their set intensity level.

This feature allows you to change the intensity for each channel itself or more than 1 at the same time (by marking the designated channels).

Note

If mi-SCAN has been activated (default setting):

- This function adjusts the electrostimulation session to the physiology of each patient. Just before starting the work session, mi-SCAN tests the muscle group and automatically adjusts the settings of the stimulator to the excitability of this area of the body.
- In order to ensure optimum efficiency and comfort of the session it is recommended to perform the mi-SCAN measurement before each session.
- This function is implemented at the beginning of the programme by a short sequence in which measurements are made.
- Throughout the duration of the test, it is important to stay still and be relaxed.
- When the test is complete, the programme can be started by increasing the intensity levels of the channels.

5. HOW TO PERFORM A TREATMENT, PERFORMANCE CHECK

Note

- Be careful to respect the order of activation of the modules, the activation order corresponds to the channel numbering.
- Colored modules process is described in the document to ease identification if needed.
- Press the central button on the Remote Control, or the On/Off button on one of the modules during stimulation, the device pauses.

Stimulation energy settings (intensity level)

For programmes which cause muscle contractions, it is important to use the maximum stimulation energies, i.e. always at the limit of what the patient is able to tolerate.

This means that, in a stimulated muscle, the number of fibres working depends on the stimulation energies.

The maximum stimulation energies must therefore be used in order to engage as many fibres as possible. Below a significant stimulation energy, the number of fibres engaged in the stimulated muscle is too low to considerably improve the quality of the muscles.

The maximum energy will not be reached during the first session but after at least 3 sessions, during which the energy to produce strong muscle contractions will be increased gradually so that the patient becomes accustomed to electrostimulation.

After the warm-up, which should produce clear muscle twitching, the stimulation energies must be increased progressively contraction by contraction throughout the work sequence.

The energies used should also be increased session by session.

For TENS treatments, stimulation is only sensory.

The intensity must therefore be increased until the patient has a pins and needles sensation (tingling) that is not considered painful.

For neuromuscular electrostimulation programmes which do not cause tetanic muscle contractions (frequencies < 10Hz), the energies must be increased gradually until muscle twitching is produced that can be clearly seen or felt.

Progression through the different levels

Generally speaking, it is not advisable to progress through the levels too quickly and to aim to reach the maximum level too quickly.

The different levels correspond to progression in rehabilitation using electrostimulation.

Furthermore and without exception, level 1 is the starting point and should be used until the therapeutic targets have been reached.

One of these targets is for the patient to be able to tolerate a significant amount of stimulation energy. Stimulation energies should therefore be given priority in order to have a many fibres working as possible before changing the level.

5. HOW TO PERFORM A TREATMENT, PERFORMANCE CHECK

5.7 Ending the treatment

When the preset therapy time elapses:

- the device stops the therapy session automatically
- the intensity of all channels drops to 0.

You can stop a treatment as well by:

- activating the pause and returning to program selection
- turning the device completely off, by pressing the On/Off button of the remote control for more than 2 seconds.

To turn the unit off, press the On/Off button on the remote control for more than 2 seconds. This will switch off all modules as well.

Note

At the end of your stimulation session it is recommended to store the remote control and the modules in the docking station to recharge the units.

5.8 Performance Check

If the unit can be operated as described above, the therapy unit has passed the performance check successfully.

The device also runs performance checks regularly during operation.

This is what happens if a problem is identified (at start or during operation):

If there is a risk in usage or a malfunction identified:

- the device will ask you to correct it (see also Chapter "Problems and Solutions")
- or automatically shut down immediately

In this situation, you may attempt to restart the unit by turning it briefly off and on again. With the unit switched off, check that all plugs are correctly connected.

If the error message persists when the unit is switched on again have the unit inspected by an authorised service technician before using it again.

6. TREATMENT OPTIONS, FUNCTIONS AND DEVICE SETTINGS

6.1 How to use the Motor Point Pen

The Motor Point Pen supports in locating the optimal electrode position for the muscle stimulation (e.g.: locating the motor point of the vastus medialis of the quadriceps).

Background:

Muscular electrostimulation programmes are programmes which subject the muscles to work. The progress achieved depends on the kind of work to which the muscles are subjected, that is to say the programme chosen. The electrical pulses generated by these programmes are transmitted to the muscles (via the motor nerve) through self-adhesive electrodes. The positioning of the electrodes is one of the determining factors in ensuring a comfortable electrostimulation session.

It is therefore essential to devote special care to this aspect. The correct placement of the electrodes and the use of significant energy allow a large number of muscle fibres to work. The greater the energy, the greater the spatial recruitment, that is to say the number of fibres working, and therefore the greater the number of fibres that make progress.

The motor point:

The motor point is a point where the motor nerve enters the muscle, which is an extremely localised area where the motor nerve is at its most excitable. Although the location of the various motor points is now well known, there may nevertheless be variations of up to several centimetres between different individuals.

The Motor Point Pen, combined with the motor point program, allows determining with greater accuracy the exact location of the motor points for each individual and thus ensuring the greatest effectiveness of the programmes. It is recommended to use this programme and the pen before any initial muscular electrostimulation session. Once located, the motor points can be easily identified by using a skin-marker pencil or in any other way, thus avoiding the need to repeat this process before each session.

Electrode placement:

One stimulation channel is a module consisting of two pods:

A positive pole (+) = the pod with an illuminated button

A negative pole (-) = the other pod of the module

The positive electrode is the one connected to the positive pod (with an illuminated button). It is supposed to be attached at the motor point of the muscle.

Note

The Motor Point Pen is designated only to be used in combination with the program "Motor Point".

6. TREATMENT OPTIONS, FUNCTIONS AND DEVICE SETTINGS

Locating the motor point with the Wireless Professional:

e.g.: locating the motor point of the vastus medialis of the quadriceps

1. Apply a large electrode at the top of the thigh (the muscle belly).
2. Connect the negative pod of the module (pod without illuminated button) to the snap pin of the large electrode located towards the inner surface of the thigh.
3. Spread a thin but even layer of conductive gel over the inner surface of the thigh in the position indicated for the positive electrode position (the motor point area), spreading the gel a few extra centimetres in all directions.
4. Connect the positive pod of the module (pod with illuminated button) to the snap connection of the motorpoint pen and bring the tip of the pen in contact with the conductive gel.
5. Switch on the remote control, select the Motor point programme (program category: Rehabilitation), then switch on the module and start the programme.
6. Very gradually increase the energy of channel 1, until a value between 5 and 25 is reached, while continuously moving the pen tip over the gel layer, but without ever losing contact with the gel, to avoid triggering an electrode fault message.
7. As soon as you observe a muscle response in form of twitching, you have located the vastus medialis motor point. Visually locate this motor point and apply a small electrode that should be centred over the motor point.
8. Remove the pen from the positive pod and connect the positive pod to the small electrode, which should be correctly centred over the motor point of the vastus medialis.



Warning!

Patient hazard - patient contamination

Before each use of the Motor Point Pen, clean and disinfect the pen, especially the tip that comes into contact with the patients skin.

Note

While using the pen, it might lose contact with the skin coated in gel (even if this is just for a fraction of a second). In this case, the stimulation will be interrupted and the equipment will signal an electrode fault. In such a case, ignore the message, put the tip of the pen back in contact with the skin and gradually increase the energy while moving the pen over the gel layer.

6. TREATMENT OPTIONS, FUNCTIONS AND DEVICE SETTINGS

6.2 Treatment Options – Muscle Intelligence™ Technology

6.2.1 Selection of the body area

mi-SCAN (automatic):



Just before starting a session of neuro-muscular electrostimulation, mi-SCAN analyses the characteristics of excitability in the muscle subjected to stimulation.

mi-SCAN detects the chronaxy of the muscle in approximately 10 seconds, by detecting when and how strong a muscle contracts while getting different intensities applied. It allows the stimulator to adjust the width (duration) of the pulse to the measured chronaxy value. Using a width (duration) of the pulse corresponding to the chronaxy of the stimulated muscle allows the use of the minimum power to obtain the same muscle response. As soon as the mi-SCAN function is activated each active channel performs the chronaxy measurement.

Where recommended, this function is automatically activated, but can be deactivated and the selection of the body part can be done manually.

Manual selection:



If the mode for the manual selection of the body area is activated, the user must manually select the area to be treated. An average chronaxy value is used based on the area selected by the user. This choice is made after selecting the desired programme.

6. TREATMENT OPTIONS, FUNCTIONS AND DEVICE SETTINGS

6.2.2 Energy management

mi-RANGE:



This function indicates the minimum energy threshold for programmes whose effectiveness requires obtaining vigorous muscular twitches. The mi-RANGE function is therefore only available for programmes using low stimulation frequencies (below 10 Hz).

For programmes that allow the mi-RANGE function, the stimulator first prompts you to increase the energy level:

- A beep will accompany the flashing “+” symbols.
- When a muscle pumping is first detected, the “+” symbols stop flashing.
- You are at the minimum energy level to provide therapeutic results.
- If you set the stimulation energy below the ideal range of treatment, the stimulator prompts you to raise them again by continuously flashing + signs.

Where recommended, this function is automatically activated.

mi-TENS:



The mi-TENS function can reduce the appearance of unwanted muscular contractions (e.g. at TENS Gate-Control programs), thus providing maximum comfort and efficiency.

Short tests are performed regularly throughout the duration of the programme.

A testing phase takes place systematically after each increase in stimulation intensity. In order to allow its smooth progress it is essential to remain perfectly still during this time.

According to the test results recorded by the device, the level of stimulation intensities may be slightly decreased automatically.

Where recommended, this function is automatically activated, but can be deactivated.

6. TREATMENT OPTIONS, FUNCTIONS AND DEVICE SETTINGS

6.2.3 Triggering of contraction

In default set up, all trigger functions are deactivated, but can be activated where available.

mi-ACTION (voluntary):



This is a way of working in which voluntary active muscle contraction triggers an electrical stimulation. Contraction by electrostimulation is perfectly controlled by voluntary triggering of muscle contraction.

From the perspective of maximum efficiency, the mi-ACTION working mode requires good muscular qualities. Underperforming muscles may, in some cases, impede the onset of electrically induced contraction.

Programmes used in the mi-ACTION mode have undeniable advantages:

- They require active participation and encourage the patient to engage fully in his or her treatment.
- They give the patient the free choice of triggering a contraction, making the practice of electrostimulation more comfortable.
- They ensure even more effective work as they combine voluntary exercises and electrostimulation that together allow for greater recruitment of muscle fibres.
- They promote the restoration of the body map and motor relearning in patients with impaired neuromuscular control.
- They allow the stimulation of stabilising muscles to be integrated during an overall functional movement.

How it works:

The mi-ACTION mode is active during muscle work sequences (it is not operational during sequences of warm-up and relaxation).

The first muscle contraction of the work sequence starts automatically.

At the end of the first contraction an active rest phase begins, characterised by muscular twitches.

The voluntary triggering of a new contraction is only possible after a minimum rest period, which varies depending on the programme.

As soon as the voluntary triggering of a contraction is possible, the device emits a beep to inform the user. Once the user hears the first sound signal composed of a beep, the triggering of voluntary contraction is possible.

If no voluntary contraction has occurred after a certain period of time, the unit will automatically pause.

To work properly, the mi-ACTION needs a good muscular twitches during the active rest phase.

6. TREATMENT OPTIONS, FUNCTIONS AND DEVICE SETTINGS

If the twitches are not significant enough, the unit beeps and a + sign appears on channels: you must increase the stimulation energy to get good twitching.

Similarly, in order to make these twitches possible, it is imperative that the muscles are properly relaxed during the resting phase.

Care should be taken at the end of each contraction phase to get back into a position allowing the best muscle relaxation.

Trigger ON (Manual triggering - Automatic stop):



It is an operating mode in which the contraction from electrostimulation is triggered by the user by pressing any button on any channel (4 multifunction buttons) on the remote control.

Contraction will stop automatically at the end of the time set by the programme.

The Trigger ON mode is active during muscle work sequences (it is not operational during sequences of warm-up and relaxation).

6. TREATMENT OPTIONS, FUNCTIONS AND DEVICE SETTINGS

6.3 Available Functions

6.3.1 The Favourite List

For a fast and easy access to the most frequently used programs, they can be added to the program category "Favourites".

It is possible to add a maximum of 10 programs to the list.

To add a program to the Favourite list, please press the multifunction button below the icon  while program is marked.

The Favorite symbol will be shown below the program while it is marked in the regular program category and the symbol above the corresponding multifunctional button will change to the symbol  for removing the program from the favorite list.

Press the button while the symbol  is shown, to remove the program from the Favorite list.

6. TREATMENT OPTIONS, FUNCTIONS AND DEVICE SETTINGS

6.3.2 The Lock Out function

The Lock Out function can be basically activated and deactivated within the menu for the Settings at the Remote Control.

If basically activated:

The Remote Control will ask before each treatment whether the lock out function shall be active for this treatment or not.

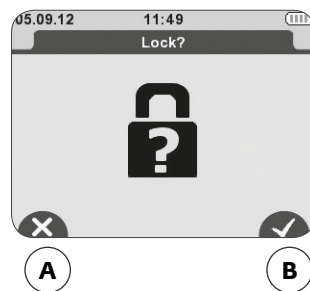

A Deactivation of the Lock function

B Activation of the Lock function

Afterwards you will be asked to enter a code.

To enter the code you just need to press a combination of any four buttons.

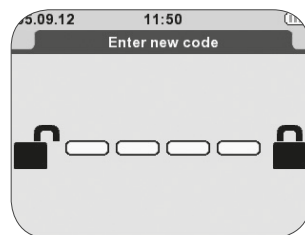

6. TREATMENT OPTIONS, FUNCTIONS AND DEVICE SETTINGS

If enabled, the function allows you to lock the device in a certain configuration before giving it to the patient.

When the function is active the patient can perform only the basic operations:

- increase or decrease the intensity,
- pause the device
- but he or she cannot exit the programme or turn off the device.

To deactivate the Lock Out function during the treatment, pause the device and then hold down the On/Off button on the Remote Control until the display prompts you to insert your key combination to unlock the programme.

If you have forgotten the code just put the remote control on the charging station to unlock.

6. TREATMENT OPTIONS, FUNCTIONS AND DEVICE SETTINGS

6.3.3 The Synchronisation Signal

Synchronisation signal:



This function allows you to notify the user by means of a sound signal of the beginning of a muscle contraction.

Before each contraction by electrostimulation the remote control emits beeps.

This function is only available for programmes inducing powerful muscular contractions and is functional only during the muscular work sequence (contraction - active rest).

It can be activated within the program option menu for each corresponding program.



6. TREATMENT OPTIONS, FUNCTIONS AND DEVICE SETTINGS

6.3.4 Identify modules

The identify modules function allows you to allocate different colors to the different modules for an easier identification of the channels during usage.

It can be activated and deactivated within the menu for the Settings at the Remote Control. Default setting is: deactivated

To activate the function:

1. Select the function within the Settings menu of the Remote Control and press the center button. You will be asked to turn ON ONE module.
2. Turn one the one of the modules you want to advice a color to.
3. Use the left and right arrows to select a color for this channel. The following colors are available: none/red/green/blue/yellow
4. Allocate the chosen color to the activated module by pressing the confirmation button . The screen will show a green hook when allocation was successful.
5. Take the reflecting colored clip to this channel and clip it onto the cable of the module (remark: the best positioning is close to the module with the on/off button).
6. Press the next button  to proceed with the process.
7. You will be asked to turn On ONE module again.
8. To allocate colors to more channels, please follow step 2 until 6 for each reflecting module.
9. When you finished the channel identification settings, press the back button  to return to device settings.

When turning on a module and during the treatment, the screen will now show the reflecting color below its intensity setting bar and in the header of the screen, in the order they had been turned on.

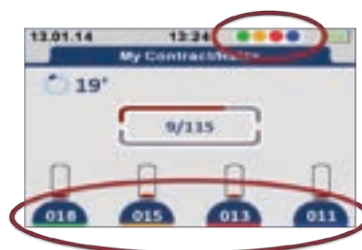

To deactivate the function again, please follow the steps 1 through 9 again, and set all modules to color: none.

6. TREATMENT OPTIONS, FUNCTIONS AND DEVICE SETTINGS

6.4 Available device Settings

Back light intensity:

The backlight intensity can be set in 5%-steps from 10% up until 100%.

Default setting: 100%

Buzzer volume:

The buzzer volume can be set in 10%-steps from 0% (= off) to 100%.

Default setting: 100%

Backlight dimmer:

The back light dimmer reduces the backlight after the set seconds of time.

Possible settings are: 15s, 30s, 60s or "off"

Default setting: 60s

Eco mode:

The eco mode can be turned on or off, while activated (on) the

Default setting: off

Lock function:

The lock out function can be activated (on) or deactivated (off).

Default setting: off

Language:

The language set up allows you to change the language setting of the Remote Control.

Default setting: English

Set time:

The set time function allows you to change the time displayed within the header of the screen.

Identify modules:

The identify modules function allows you to allocate different colors to the different modules for an easier identification of the channels during usage.

Default setting: off

Date:

The set time function allows you to change the date displayed within the header of the screen.

System info:

The system info provides information regarding the serial number and the software of the Remote Control.

6. TREATMENT OPTIONS, FUNCTIONS AND DEVICE SETTINGS

Pairing of new module:

The pairing of new module function enables you to add a new module to the Remote Control (usually done automatically by the unit). 1 up 4 modules can be operated max with one Remote Control.

Rest to factory setting:

This function activated, resets the Remote Control to the default setting. All data stored on the remote control, incl. Device settings, favourites, history etc. will be automatically deleted.

6. TREATMENT OPTIONS, FUNCTIONS AND DEVICE SETTINGS

6.5 WIRELESS PROFESSIONAL SOFTWARE (firmware update remote control, customised programs, patient history)

The WIRELESS PROFESSIONAL SOFTWARE is a software to be installed on your Computer to extend the capabilities of your WIRELESS PROFESSIONAL 2 and 4CH devices.

The key features included with the SOFTWARE are:

- Update the firmware of your WIRELESS PROFESSIONAL remote Control
- Create your own customized stimulation programs
- Create a patient list and monitor their therapy progress

You can download the SOFTWARE to your computer from
<http://international.chattgroup.com/products/wireless-professional/>

6.5.1 Firmware update of the Remote Control

The WIRELESS PROFESSIONAL SOFTWARE always contains the latest version of the WIRELESS PROFESSIONAL firmware of the remote control and modules.

To update your Remote Control:







1. Download the SOFTWARE from
<http://international.chattgroup.com/products/wireless-professional/>
2. Run the SOFTWARE
3. Connect your Remote Control to your Computer

The firmware of your remote control will be automatically updated by the SOFTWARE.
Your modules will be automatically updated by the Remote Control when turning them on within the next treatment session.

6. TREATMENT OPTIONS, FUNCTIONS AND DEVICE SETTINGS

6.5.2 Additional Functions of the SOFTWARE, when having a WIRELESS PROFESSIONAL device

When having a WIRELESS PROFESSIONAL device the SOFTWARE allows you additional functions to be used with your Remote Control.

	<p>History List: When having the Remote Control synchronised with your Computer, all performed treatments will be shown in this list in the order they had been performed, the latest first.</p>
	<p>Patient List: Will show all patients you added to this list, the notes you made on them and the history of their treatments.</p>
	<p>User Program List: Will show all programs you created and their parameters.</p>
	<p>Synchronisation: To synchronise the Remote Control and the SOFTWARE</p>
	<p>Settings: For database and application configuration.</p>
	<p>Help: You will find instructions to use the SOFTWARE and warnings in here.</p>





6. TREATMENT OPTIONS, FUNCTIONS AND DEVICE SETTINGS

6.5.2.1 History list

When having the Remote Control synchronised with your Computer, all performed treatments will be shown in this list in the order they had been performed, including date, time, patient name (if it was assigned to a patient from the patient list) and program name, the latest first.

When clicking on the extend symbol  of a session, the session details will be shown.

Session details are:

	Treatment time
	Number of contractions
	Average intensity of all channels used
	Maximum intensity per channel

You can delete a session from the list by clicking on the delete  button.

You can close the details view by clicking on the reduct  button.



You can export the list into an Excel file, by clicking on the export  button. The SOFTWARE will automatically suggest a name for that file and ask for the location it should be stored to.

6. TREATMENT OPTIONS, FUNCTIONS AND DEVICE SETTINGS

6.5.2.2 Create a patient's list and monitor their treatment progress

The Patient list will show all patients you added to this list, the notes you made on them and the history of their treatments (automatically transferred from the History List).







To add a patient to the list:

1. Click on the Add  button
2. Fill the requested fields for the patient's personal data. The fields Name, Surname and Pseudonyme are mandatory. The field Pseudonyme will be filled automatically, but can be changed after.
3. Add Pathology information of notes, if wanted
4. Click on the confirmation/store  button. The button appears as soon as the mandatory fields had been filled.

The patient will be automatically shown within the patient list.

If you don't want to store the data, click on the back  button, to return to the patient list. All inserted data will be deleted.

Within the patient list you can:

- Select a patient by clicking on the name.
- Edit/Change the patient's data by clicking on the edit  button.
- Export the patient history list into an Excel file, by clicking on the export  button. The SOFTWARE will automatically suggest a name for that file and ask for the location it should be stored to.
- Delete a patient from the list by clicking on the delete  button.
- View details on each treatment of the patient by clicking on the extend  button and reduce the details view by clicking on the reduce  button. (see as well History List)
- Mark a patient  to be synchronised and become available with your remote control. If you don't want the patient to be synchronised with your remote control, click on the hook button to remove the hook  from the field.

Default setting: synchronisation on 

When patients had been added to the patient list and synchronised with the remote control, your WIRELESS PROFESSIONAL will ask you after each treatment session to add the last treatment to a patient from your patient list.

To do so:

- Press the next or the center button when the treatment time elapsed
- The patient list will be displayed automatically. Select a patient by using the up/down buttons.
- Confirm by using the confirmation  button or the center button

If you don't want to assign this treatment to a patient of your list, just press the return  button to return to the available programs and program category.



The treatment will become visible within the history list and the patient list when synchronising the remote control with your computer the next time.

6. TREATMENT OPTIONS, FUNCTIONS AND DEVICE SETTINGS

6.5.2.3 Create customized stimulation programs

When having a WIRELESS PROFESSIONAL the SOFTWARE allows you to create your own stimulation programs.

It is possible to adjust the treatment parameters and create your own stimulation programs, based on the following program architectures:

	<p>Continuous Programs</p> <p>Adjustable parameters:</p> <ul style="list-style-type: none"> • Impulse width • Treatment session length • Frequency
	<p>Modulated Programs</p> <p>Adjustable parameters:</p> <ul style="list-style-type: none"> • Treatment session length • Frequency • Impulse width
	<p>Work/Relax Programs</p> <p>Adjustable parameters:</p> <ul style="list-style-type: none"> • Impulse width • Treatment session length • Warm up / Cool down (on/off) <p>And for the Work and Relax phases separately</p> <ul style="list-style-type: none"> • Frequency • Duration • Ramp up duration • Ramp down duration

Values of the adjustable parameters:

Treatment session length: 1 – 240 minutes

Impuls width: 30 – 400 μ s

Frequency: 1 – 150 Hz (at Work/Relax: 0 – 20 Hz for the Relax phase)

Ramp-up duration: 0.25 – 10 seconds

Ramp-down duration: 0 – 2 seconds at Work and 0.25 – 2 seconds at Relax



Duration: 0.25 – 60 seconds

Warm-up/Cool down: On/Off

Note: when activating the warm-up/cool down function, the program will automatically add 5 minutes for warm-up and 10 minutes for cool down to your set treatment time.

6. TREATMENT OPTIONS, FUNCTIONS AND DEVICE SETTINGS

To create your own treatment program the first time:





1. Click on Program 
2. Click on the architecture symbol your program is selected to have
3. Enter a name for the program (mandatory) and notes (optional)
4. Adjust the parameter, by clicking on the parameter and changing the values with the + and – buttons on the screen.
5. Store the program by clicking on the green hook button . This button will be displayed as soon as the mandatory field had been filled.

Your new programs will be shown in the “user program list”.

If you don't want to store the program, click on the back  button, to return to the program list. All inserted data will be deleted.

The User Program List will show all your created programs.

Within the Program List you can:

- Select a program by clicking on the name. When clicking on it, all set parameter and the architecture of the program will be shown.
- Edit/Change the program parameter and notes by clicking on the edit  button.
- Export the program parameters into an WIRELESS PROFESSIONAL SOFTWARE file, by clicking on the export  button. The SOFTWARE will automatically suggest a name for that file and ask for the location it should be stored to. This feature allows you to share it with any other Computer the SOFTWARE is installed on.
- Delete a program from the list by clicking on the delete  button.
- Mark a program  to be synchronised and become available with your remote control. If you don't want the program to be synchronised with your remote control, click on the hook button to remove the hook  from the field.

Default setting: synchronisation on 

6. TREATMENT OPTIONS, FUNCTIONS AND DEVICE SETTINGS

All programs that had been synchronised with your Remote Control, will be shown in a separate program category called "Personalised Programs".

Please note:

- Programs from the Personalised Programs category list cannot be added to the Favorite program category.
- Mi functions will not be available for customised programs
- Different treatment options to be turned on or off, will be available for the 3 different program architectures:
 - Modulated Programs: none
 - Continuous Programs: Bodyzone selection
 - Work/Relax Programs: Bodyzone Selection, Synchronisation Signal and Triggering of contraction (please note, apart from the regular trigger function, the stimulation will only last as long as the trigger button will be pressed)
- The information shown in relation to a program will be the information/notice entered within a program at the SOFTWARE (if there is one) and the set program parameters.
- When selecting a program, the remote will not automatically ask you to turn on the Modules and start the treatment. For customized programs, the architecture and parameters of this customised program will be displayed first. You can confirm that this is the parameters you want to treat the patient with by pressing START and the remote control will ask you to turn on the Modules afterwards.

6. TREATMENT OPTIONS, FUNCTIONS AND DEVICE SETTINGS

6.5.2.4 Remote Synchronisation

During the synchronisation process, selected custom programs will be automatically transferred to your device and will be available under the "Personalised Programs" category. Likewise, the patient's list will also be transferred to your device, and will allow assigning stimulation sessions to a particular patient. During this process, stimulation session's history stored on your Wireless Professional device will also be transferred to the software.

The screen will show a symbol for your computer and the Remote Control, connected by a line.

- If there is no remote connected, the line will be interrupted by a red X.
- If there is a remote connected to the computer, the Synchronisation symbol will interrupt the line.

To synchronise, click on the synchronisation symbol. The circle on it will start turning while the synchronisation is in process.

Please do not disconnect your remote control from your computer during the synchronisation process, or the process will fail.

6. TREATMENT OPTIONS, FUNCTIONS AND DEVICE SETTINGS

6.5.2.5 Configuration/Settings

Within the Configuration/Setting menu, it is possible to change the application configuration by selecting different languages.

The following languages are available:

- English
- French
- German
- Spanish
- Italian
- Dutch
- Turkish
- Portuguese
- Danish
- Swedish
- Norwegian
- Finnish
- Czech
- Russian
- Polish
- Greek

It is as well possible to manage your data base with the following functions:

1. Backup / Restore your data:

The database administration tab allows you to backup all your data (history, patient's list and custom programs) in a file that can be saved on any storage system. Just click on "backup" and the SOFTWARE will automatically suggest a name for the backup file and ask you where you want to store it.

If necessary, this backup file can then be used to Restore your data.

Just click on "Restore", select the file you want to use to restore your system and confirm.

2. Clear all data

Clicking on "Clear all data" will delete all stored data within the SOFTWARE and reset the SOFTWARE to the default setting.

And the information about the SOFTWARE is included:

- Disclaimer
- Version
- Contact

6. TREATMENT OPTIONS, FUNCTIONS AND DEVICE SETTINGS

6.5.2.6 Help

The Help tap contains a summary of all information required to use the SOFTWARE, including the warnings.

7. TROUBLESHOOTING

7.1 Errors shown on display

Poor electrode/module contact

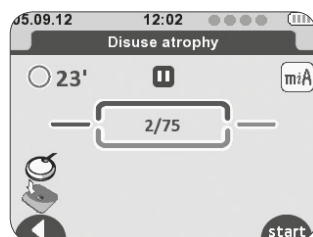

The remote control shows the symbol of an electrode and a disconnected module. Shown on the channel where the problem was detected (in this case channel 1):

Problem	Possible cause	Solution
Electrode failure	Poor electrode connection to the module	Check that the electrodes are properly connected to the module.
	Poor electrode connection to the skin	Check if the electrodes are outdated, worn and/or the contact is poor: try with new electrodes.

7. TROUBLESHOOTING

Modules out of range

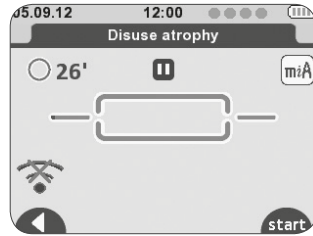

The remote control shows the out of range symbol. Shown on the channel where the problem was detected (in this case channel 1):

Problem	Possible cause	Solution
No connection with modules	Modules are out of range from Remote Control	A. Check that the module and the remote control are less than 2 metres away. B. Ensure you are not in an isolated place, without any obstacles that may deflect the signals from the remote control. C. Ensure you are in a place that allows the signal from the remote control to be reflected. D. Check the module is switched on.

7. TROUBLESHOOTING

Battery level

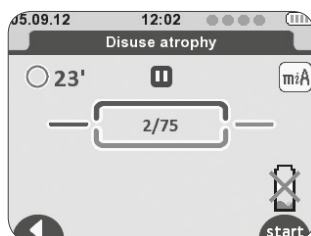

The remote control shows a discharged battery symbol. Shown on the channel where the problem was detected (in this case channel 4):

Problem	Possible cause	Solution
Module battery low	During the stimulation a module may turn out to be discharged.	Stop the stimulation and recharge the discharged module.

7. TROUBLESHOOTING

7.2 Behaviour of the Module LEDs

Problem	Possible cause	Solution
The LED blinks alternately green and red	The module is out of range or is not recognised by the Remote Control.	<ul style="list-style-type: none"> A. Check the remote control is properly turned on. B. Check that the module and the remote control are less than 2 metres away. C. Try restarting the module. D. Place the module and the remote control on the same docking station in order to pair them.
The LED is constantly red	Module battery level low	<ul style="list-style-type: none"> A. Check the module is charged. B. Try restarting the module. C. If despite this the LED is still red, contact the customer services that have been stipulated and approved by the manufacturer.

7. TROUBLESHOOTING

7.3 Behaviour of the Docking Station LEDs

Problem	Possible cause	Solution
The docking station's central LED lights red	Modules can't be charged due to no connection to tablet or main power.	<p>A. Ensure that the modules are properly placed in their housing.</p> <p>B. Ensure the charging contacts are clean.</p> <p>C. Ensure the correct AC adapter is used.</p> <p>D. Disconnect and reconnect the docking station and check the lighting sequence of the docking station upon activation.</p> <ul style="list-style-type: none"> • Remove all modules. • Remove the remote control. • Disconnect the USB cable. <p>If despite this the LED is still red, contact the customer services that have been stipulated and approved by the manufacturer.</p>

7. TROUBLESHOOTING

7.4 Others

Problem	Possible cause	Solution
The stimulator is not working	Device not answering	<p>If the remote control is ON, but does not respond to pressing the key pad buttons:</p> <ul style="list-style-type: none"> A. Press the ON/OFF button for 2 seconds to turn the device OFF B. Wait 10 seconds. C. Turn Remote Control ON again
	Low batteries	<p>Ensure the remote control and the modules are charged. When the batteries are completely discharged, charging for a few minutes may be required before the unit turns on.</p> <ul style="list-style-type: none"> A. Try to restart the remote control and modules. B. Place the module and the remote control on the same docking station in order to pair them. C. If, despite this, the device is still not working, contact the customer services that have been stipulated and approved by the manufacturer.
	Bad connections	<p>If the device is on, the intensity bar graphs and controls are on, and you feel no stimulation, check and verify the connection of the electrodes</p>
	Lead wire or electrode defective	<p>If the device appears to be functioning, and there is no stimulation, replace the lead wires and/or electrodes</p>

7. TROUBLESHOOTING

Problem	Possible cause	Solution
Display does not come on	Low batteries	Load batteries
Weak stimulation with loaded batteries	Electrodes dried out, lost their adhesive power and have no adequate connection to th skin.	Replace electrode
	Electrode placement	Make the electrodes at least 2" apart
Stimulation stops with loaded batteries	Poor electrode contact	Reapply electrodes, secure firmly. Electrodes must be a minimum of 2 inches apart.
	Damaged or worn electrodes or module leadwires	Replace.
Stimulation weakens within minutes of starting treatment with loaded batteries	This is a normal body adaptive process	Increase the amplitude (intensity) if required.
Stimulation is uncomfortable	Amplitude (intensity) is too high	Decrease amplitude (intensity).
	Electrodes are too close together	Reposition the electrodes. Electrodes must be a minimum of 2 inches apart.
	Damaged or worn electrodes or leadwires of modules	Replace.
	Ensure proper program is being used	A. Refer to section 6.1 and 7 for a description of the Programs B. Contact clinician if discomfort persists.
Stimulation is ineffective	Improper electrode placement	Reposition electrodes. Electrodes must be a minimum of 2 inches apart.
	Unknown	Contact clinician.
Stimulation only felt on one electrode	Improper electrode placement	A. Reposition electrodes. Electrodes must be a minimum of 2 inches apart. B. Replace electrodes.

7. TROUBLESHOOTING

Problem	Possible cause	Solution
Stimulation on one channel (side) only	Electrodes A. Worn or damaged B. Improper placement Leadwires among modules worn or damaged	A. Replace. B. Reposition electrode. Electrodes must be a minimum of 2 inches apart.
		Replace
Intermittent Output	Intermittent program in use	Some programs will seem intermittent. This is expected. Refer to section 6.1 for a description of the Programs.
Stimulation is not producing the usual sensation	Settings and Electrodes positioning	A. Check that all the settings are correct and ensure the electrodes are positioned properly. B. Change the positioning of the electrodes slightly.
Remote Control is not loading	USB cable of docking station not connected to Tablet	Check connections
	Power cord of Tablet not connected to mains	
Modules are not loading	Power cord of Tablet not connected to mains	Check connections
	Modules not placed the right way	Check module placement in Tablet

8. CARE, MAINTENANCE, TRANSPORT, ENVIRONMENTAL STATEMENT

8.1 Care



Warning!

Shock hazard - Remove the power cord of the Tablet from the wall outlet before cleaning.
Shock hazard, equipment damage -

- Liquids must not enter the device and its components, incl. the Tablet. If liquids have entered into the components, the Wireless Professional must be immediately checked by a service technician, before it can be reused.
- Never dismantle the remote control, the modules, the docking station or the AC adapter as they contain high-voltage parts with a risk of electric shock.

- All parts of the Wireless Professional can be disinfected by **wiping down** with a disinfectant. Thus, it complies with the special hygiene standards for medical technical equipment.
- **All components** can be cleaned with common **disinfectants** and **mild household detergents**.
- Only use a **soft cloth** and an alcohol-based, solvent-free cleaning product, to wipe the therapy unit down.
- Allow the device to completely dry before use.



Warning!

Patient hazard - patient contamination

- Before using the unit on another patient, clean and disinfect it according to the instructions in this section.



Caution!

Equipment damage -

- The plastic material used is not **resistant** to mineral acids, formic acid, phenols, cresols, oxidants and strong organic or inorganic acids with a pH value below 4.
- Use only clear disinfectants to prevent discoloration of the device.
- Do not expose the therapy unit to strong ultraviolet radiation (sunlight) and fire.
- Do not sterilize the stimulator.
- Do not immerse in liquids.

8. CARE, MAINTENANCE, TRANSPORT, ENVIRONMENTAL STATEMENT

8.2 Maintenance

Your Wireless Professional does not require calibration or frequently safety testings. Each stimulator is tested prior to distribution. Its characteristics do not vary under normal conditions.

If your stimulator contains parts that seem worn or defective, please stop using it and contact the customer service centre that has been stipulated and authorised by the manufacturer regarding an upgrade.

There are no user serviceable parts inside the device. If the device appears to be non-functional, contact DJO Global or your local dealer.



Warning!

Shock hazard, Equipment damage -

Do not attempt to repair the stimulator or any of its accessories. Never dismantle the device because of risk of electric shock. DJO Global declines all responsibilities for any damages or consequences resulting from unauthorised attempts to open, modify, or repair the stimulator. This may only be done by persons or repair services authorized by the manufacturer

8. CARE, MAINTENANCE, TRANSPORT, ENVIROMENTAL STATEMENT

8.3 Transport

8.3.1 Transport of the 4CH device key components and the Tablet (off site treatment)

1. Prepare the device and its accessories for shipping within the original Rehab/Theta/Physio shipping box
2. Turn the device and it's accessories off.
3. Disconnect and dismount the device and it's accessories by following the guidelines
4. Place the accessories within the box as shown in the pictures below.
5. Store the user manual in the CD pocket of the transport bag.



Caution!

Equipment damage -

Only use the original transport bag for carrying the device around.

1. Turn the device and it's accessories off.
2. Disconnect and dismount the device and it's accessories by following the guidelines but keep the Modules in the Tablet.
3. Store the user manual in CD in the outer pocket of the transport bag.
4. Place the accessories in the transport bag as shown in picture below

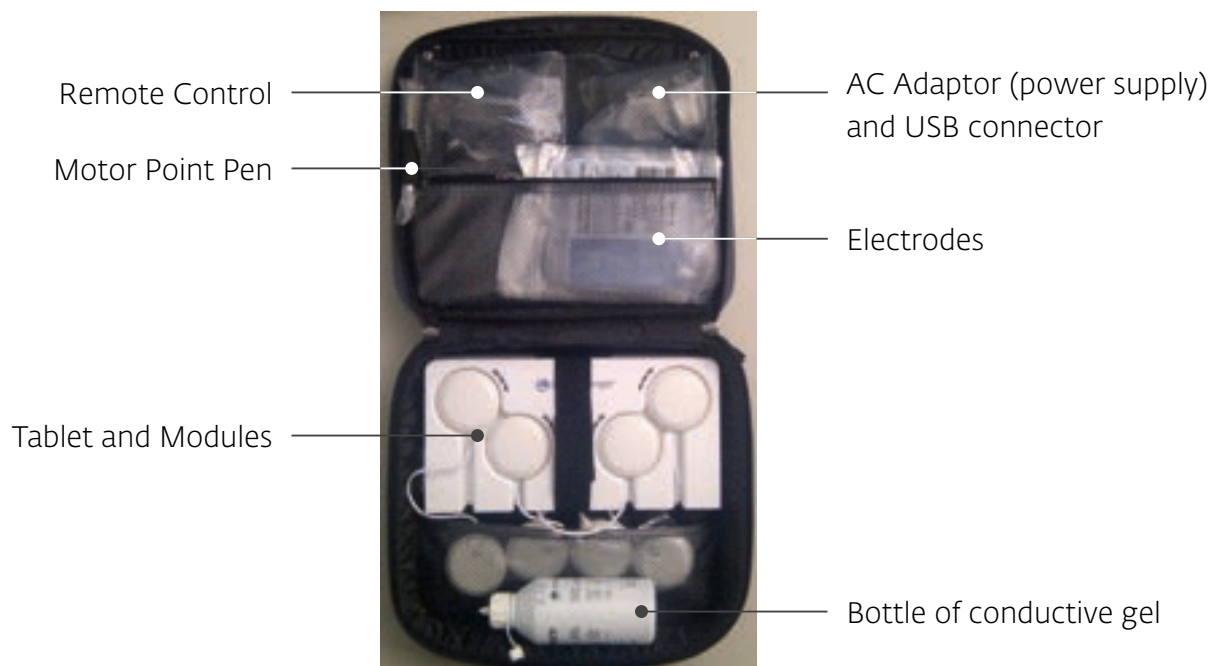

8. CARE, MAINTENANCE, TRANSPORT, ENVIROMENTAL STATEMENT

8.3.2 Shipping the entire 4CH unit (incl. Smart Docking Station)



Caution!

Equipment damage -

Only use the original shipping box for shipping the device. DJO cannot be held liable for transport damage if the device is not packed in its original shipping box.

1. Prepare the device and its components for shipping within the original Wireless Professional shipping box, by following the guidelines given previously.
Do not place the Remote Control, the user manual and the Bottle of Conductive Gel within the transport bag.
2. Place the components within the box like shown in the pictures below.
 - a. Place the transport bag at the bottom of the (paper) shipping box
 - b. Cover the transport bag with the paper spacer
 - c. Cover the Docking Station with the protective paper piece and place it in the box
 - d. Place the Bottle of Conductive Gel in the Box
 - e. Put the Remotes Control in their separate paper box
 - f. Place the Remotes Control Box in the slots at the surface.
 - g. Close the Transport Box

a.



b.



c.



d.



e.



f.



8. CARE, MAINTENANCE, TRANSPORT, ENVIROMENTAL STATEMENT

8.3.3 Transport of the 2CH device key components



Caution!

Equipment damage -
Only use the original transport bag for carrying the device around.

1. Turn the device and it's components off.
2. Disconnect and dismount the device and it's components by following the guidelines
3. Place the components in the transport bag as shown in picture below



8. CARE, MAINTENANCE, TRANSPORT, ENVIRONMENTAL STATEMENT

8.3.4 Shipping the entire 2CH unit (incl. Basic Docking Station)



Caution!

Equipment damage -

Only use the original shipping box for shipping the device. DJO cannot be held liable for transport damage if the device is not packed in its original shipping box.

1. Prepare the device and its components for shipping within the original Wireless Professional shipping box, by following the guidelines given previously.
2. Place the components within the box like shown in the pictures below.
 - a. Place at the bottom the electrodes and user guide on CD in the specific box
 - b. Cover the electrode and user guide with the paper spacer
 - c. Place the docking station in a specific box and insert it in the room allowed by the paper spacer
 - d. Put the Remote Control and module in its separate foam box, put it into the paper spacer and cover the docking station box. Cover the Docking Station with the protective paper piece and place it in the box.
 - e. Close the Transport Box

8. CARE, MAINTENANCE, TRANSPORT, ENVIROMENTAL STATEMENT

8.4 Enviromental Statement, Expected Life

The Wireless Professional device is electronic equipment and may include substances that can damage the environment. It must not be dispose of with unsorted household or municipal waste. It requires separate disposal at a suitable collection point for recycling of electronic equipment. By doing so, you will be contributing to the safeguarding of natural resources and health. Please contact DJO GLOBAL for information about the possible recycling of the product.

When the electrodes no longer stick well to your skin, dispose of them in a receptacle out of reach of children and pets.

The product as well as the parts and accessories supplied with it are designed for a minimum service life of 6 years of normal usage.

9. TECHNICAL DATA, STANDARDS, GUARANTEE, PATENTS

9.1 Technical Data

9.1.1 General information

Model:	Wireless Professional 4CH
Part number:	2532xxx
MDD:	Class IIa
IP class:	IP22
Applied part:	Type BF
Power supplies:	
Remote Control battery:	Lithium polymer (LiPo) rechargeable 3.7[V] / ≥ 1500 [mAh].
Module batteries:	Lithium polymer (LiPo) rechargeable 3.7[V] / ≥ 450 [mAh].
Tablet AC Adaptor:	Only 5 [V] / 3.5 [A] adapters with the reference number 6490xx can be used to recharge the Wireless Professional.
Battery life:	Battery life of Remote control and Module batteries: approx. 5 years, cannot be replaced by the user!

Model:	Wireless Professional 2CH
Part number:	25326xx
MDD:	Class IIa
IP class:	IP22
Applied part:	Type BF
Power supplies:	
Remote Control battery:	Lithium polymer (LiPo) rechargeable 3.7[V] / ≥ 1500 [mAh].
Module batteries:	Lithium polymer (LiPo) rechargeable 3.7[V] / ≥ 450 [mAh].
Tablet AC Adaptor:	Only 5 [V] / 3.5 [A] adapters with the reference number 6490xx can be used to recharge the Wireless Professional.
Battery life:	Battery life of Remote control and Module batteries: approx. 5 years, cannot be replaced by the user!

9. TECHNICAL DATA, STANDARDS, GUARANTEE, PATENTS

9.1.2 Neuro-Stimulation Parameters

All electrical specifications are given for an impedance of 500-1,000 ohms per channel.

Outputs:	Four independent and individually adjustable channels that are electrically isolated from each other.
Pulse shape:	Constant rectangular current with pulse compensation to eliminate any direct current component to prevent residual polarisation at skin level.
Maximum pulse intensity:	120 mA.
Pulse intensity increments:	Manual adjustment of stimulation intensity from 0 to 999 (energy) in minimum increments of 0.25 mA.
Pulse width:	30 to 400 μ s.
Maximum electrical charge per pulse:	96 micro coulombs ($2 \times 48 \mu$ C, compensated)
Standard pulse ramp-up time:	3 μ s (20 %-80 % of maximum current)
Pulse frequency:	1 to 150 Hz.

9.1.3 RF data

The Wireless Professional may be affected by other devices even if they are compliant with CISPR EMISSION requirements.

Transmission and reception frequency:	2.4 [GHz] ISM (2.4-2.4835 GHz)
Characteristics of the modulation type and frequency:	GFSK, +/-320 [kHz] deviation
Effective transmission power:	4.4 [dBm]

9. TECHNICAL DATA, STANDARDS, GUARANTEE, PATENTS

9.1.4 Information on electromagnetic compatibility (EMC)

The Wireless Professional is designed to be used in typical environments that have been approved in accordance with the EMC safety standard EN 60601-1-2.

This device complies with the CISPR standard, indicating that radio frequency (RF) emissions are not likely to cause interference with electronic equipment installed nearby (radios, computers, telephones, etc.).

The Wireless Professional is designed to withstand foreseeable disturbances from electrostatic discharge, magnetic fields from the mains power supply or RF transmitters.

Nevertheless, it is not possible to ensure that the stimulator will not be affected by powerful RF (radio frequency) fields from other sources.

For more detailed information concerning electromagnetic emissions and immunity, refer to the EMC tables.

9.1.5 Environmental conditions

Storage and Transport Conditions

The device must be stored and transported in accordance with the following conditions:

Temperature:	-20° C to 45°C
Maximum relative humidity:	75%
Atmospheric pressure:	700 hPa to 1,060 hPa

Conditions of use

Temperature:	0° C to 40° C
Maximum relative humidity:	30% to 75%
Atmospheric pressure:	700 hPa to 1,060 hPa

9. TECHNICAL DATA, STANDARDS, GUARANTEE, PATENTS

9.2 Standards

To guarantee your safety, the Wireless Professional has been designed, manufactured, and distributed in compliance with the requirements of European Directive 93/42/EEC, as amended, on medical devices.

The Wireless Professional also complies with the IEC 60601-1 standard on general safety requirements for electro-medical devices, the IEC 60601-1-2 standard on electromagnetic compatibility, and the IEC 60601-2-10 standard on particular safety requirements for nerve and muscle stimulators.

Current international standards require that a warning be given concerning the application of electrodes to the thorax (increased risk of cardiac fibrillation).

The Wireless Professional also complies with Directive 2012/19/EU on waste electrical and electronic equipment (WEEE).

9.3 Guarantee

This guarantee is valid only if it is accompanied by proof of purchase.
Your statutory rights are not affected by this guarantee.

Your Wireless Professional stimulator is guaranteed for a period of 3 years from the date of purchase. The guarantee covers the remote control, the modules, the docking station and the AC adaptor (hardware and labour), but not the batteries, electrodes or the motor point pen.

All defects resulting from poor quality material or workmanship are covered.

This guarantee does not cover damage resulting from impact, accidents, misuse, inadequate protection against moisture, immersion in water or repairs made by unauthorised personnel.

9.4 Patents

The Wireless Professional incorporates several innovations with patents pending or already issued.

10. EMC TABLES

10. EMC Tables

The Wireless Professional needs special EMC precautions and must be installed and started according to the EMC information supplied in this manual.

All RF wireless transmission systems can affect the Wireless Professional.

The use of accessories, sensors and cables other than those recommended by the manufacturer may result in stronger emissions or reduce the immunity of the Wireless Professional.

The Wireless Professional should not be used beside or stacked on top of any other equipment. If you must use it side by side or on top of another system, you should check that the Wireless Professional works properly in the chosen configuration

The product designation of the Wireless Professional used in the text below includes all product variants.

10.1 Electromagnetic emissions

RECOMMENDATIONS AND DECLARATION BY THE MANUFACTURER CONCERNING ELECTROMAGNETIC EMISSIONS

The device is intended for use in the electromagnetic environment specified below.

The customer or user of the device should ensure that it is used in this environment

Emissions test	Compliance	Electromagnetic environment - Guide
RF emissions CISPR 11	Group 1	The Wireless Professional uses RF energy only for its internal operation. Consequently, its RF emissions are unlikely to interfere with any adjacent electrical device (radios, computers, telephones etc.).
RF emissions CISPR 11	Class B	Wireless Professional is suitable for use in any establishment, other than a private dwelling or a place connected directly to the low voltage mains supply which powers residential buildings.
Harmonic emissions IEC 61000-3-2	Class A	
Voltage fluctuations / emission oscillations IEC 61000-3-3	Not applicable	

10. EMC TABLES

10.2 Electromagnetic immunity

RECOMMENDATIONS AND DECLARATION BY THE MANUFACTURER CONCERNING ELECTROMAGNETIC IMMUNITY			
Wireless Professional is designed for use in the electromagnetic environment stipulated below. The buyer or user of the Wireless Professional must ensure it is used in this recommended environment.			
Immunity test	Test level IEC 60601	Observance level	Electromagnetic environment - Recommendations
Electrostatic discharge (DES) CEI 61000-4-2	±6 kV at the contact ±8 kV in air	±6 kV at the contact ±8 kV in air	Floors must be wood, concrete or ceramic tile. If floors are covered with synthetic material the relative humidity must be maintained at a minimum of 30%.
Fast transient electrical bursts CEI 61000-4-4	±2 kV for power supply lines ±1 kV for input/output lines	Not applicable Battery-powered device	The quality of the electrical power supply should be that of a typical commercial or hospital environment.
Shock waves CEI 61000-4-5	±1 kV differential mode ±2 kV joint mode	Not applicable Battery-powered device	The quality of the power supply should be that of a typical commercial or hospital environment.
Voltage dips, short interruptions and voltage variations on power supply lines CEI 61000-4-11	<5 % VT (dips >95 % de UT) for 0.5 cycle <40 % VT (dips >60 % de UT) for 5 cycles <70 % VT (dips >30 % de UT) for 25 cycles <5 % VT (dips >95 % de UT) for 5 seconds	Not applicable Battery-powered device	The quality of the power supply should be that of a typical commercial or hospital environment. If the Wireless Professional user requires continuous operation during mains power cuts, it is recommend that the Wireless Professional is powered by a UPS or a battery.
Magnetic field at grid frequency (50/60 Hz) CEI 61000-4-8	3 A/m		Magnetic fields at the mains frequency should be at a level characteristic of a typical location in a typical commercial or hospital environment.
NOTE :VT is the AC supply voltage before application of the test level.			

10. EMC TABLES

RECOMMENDATIONS AND DECLARATION BY THE MANUFACTURER CONCERNING ELECTROMAGNETIC IMMUNITY			
Wireless Professional is designed for use in the electromagnetic environment stipulated below. The buyer or user of the Wireless Professional must ensure it is used in this recommended environment.			
Immunity test	Test level IEC 60601	Observance level	Electromagnetic environment - recommendations
<p>Conducted RF IEC 61000-4-6</p> <p>Radiated RF IEC 61000-4-3</p>	<p>3 Vrms 150 kHz to 80 MHz</p> <p>3 V/m 80 MHz to 2.5 GHz</p>	<p>3 Vrms</p> <p>3 V/m</p>	<p>Portable and mobile RF communication devices must only be used relative to the Wireless Professional and its wiring at a distance which is not less than the spacing recommended and calculated using the appropriate equation for the transmitter’s frequency.</p> <p>Recommended spacing $d = 1.2 \sqrt{P}$ $d = 1.2 \sqrt{P}$ 80 MHz to 800 MHz $d = 2.3 \sqrt{P}$ 800 MHz to 2.5 GHz where P is the maximum output power of the transmitter in watts (W) set by the manufacturer’s specifications and where d is the recommended spacing in metres (m). The field intensity of RF fixed transmitters, as determined by an electromagnetic survey a must be less than the observance level to be found in each frequency range. Interference may occur close to any appliance identified by the following symbol:</p> 
NOTE 1 At 80 MHz and at 800 MHz ,the high frequency amplitude is applied			
NOTE 2 These guidelines may not be appropriate for some situations. Electromagnetic wave propagation is modified by absorption and reflection due to buildings, objects and persons.			
<p>a The field intensity from fixed transmitters, such as radio telephone base stations (cellular/ wireless) and a mobile radio, amateur radios, AM and FM radio transmissions and TV transmissions cannot be predicted with any accuracy. It may therefore be necessary to consider an analysis of the electromagnetic environment of the site to calculate the electromagnetic environment coming from fixed RF transmitters. If the field intensity measured in the environment where the Wireless Professional is located exceeds the appropriate RF observance level above, the Wireless Professional should be monitored to ensure it is operating properly. In the event of abnormal operation, new measures may then be imposed, such as realignment or movement of the Wireless Professional.</p> <p>b Above the frequency amplitude from 150 kHz to 80 MHz, the field intensity must be < 3 V/m.</p>			

10. EMC TABLES

10.3 Recommended separation distances

RECOMMENDED SPACING BETWEEN A PORTABLE AND MOBILE COMMUNICATION DEVICE AND THE WIRELESS PROFESSIONAL

The Wireless Professional is designed for use in an electromagnetic environment in which radiated RF waves are controlled. The buyer or user of the Wireless Professional can contribute to preventing electromagnetic interference by maintaining a minimum distance between portable and mobile RF communication devices (transmitters) and the Wireless Professional according to the table of recommendations below and according to the maximum output power of the telecommunication device.

Maximum transmitter output power W	Spacing according to the frequency of the transmitter m		
	From 150 kHz to 80 MHz $d = 1.2 \sqrt{P}$	From 80 kHz to 800 MHz $d = 1.2 \sqrt{P}$	From 800 MHz to 2.5 GHz $d = 2.3 \sqrt{P}$
0.01	0.12	0.12	0.23
0.1	0.38	0.38	0.73
1	1.2	1.2	2.3
10	3.8	3.8	7.3
100	12	12	23

In the case of transmitters whose maximum output power is not shown in the table above, the recommended spacing of d in metres (m) can be calculated using the appropriate equation for the transmitter frequency, where P is the maximum output power of the transmitter in watts (W) as set by the transmitter manufacturer

NOTE 1 At 80 MHz and at 800 MHz, the spacing for high frequency amplitude is applied.

NOTE 2 These guidelines may not be appropriate for some situations. Electromagnetic wave propagation is modified by absorption and reflection due to buildings, objects and persons.

Note

Mobile HF-Communication units may have influence to the Wireless Professional.

Please ensure that wireless communication devices, like WLAN, mobile phones, wireless telephones and their station, Walki-Talkies keep a distance to the Wireless Professional of at least 3.3 m. (Based upon the maximum output power of a regular mobile phone of 2 W).

11. CONTACT

We would be happy to answer any questions you may have about our products and services. Please contact your local dealer, or your corresponding DJO Global site. DJO Global sites are listed on the backside of the cover.

For technical service from DJO Global, please contact:

internationalproductsupport@DJOglobal.com

12. ELECTROTHERAPY THEORY

12.1 Introduction

In recent years, significant progress has been made in field of electrotherapy of which many users are still largely unaware. Changes and improvements in electrotherapy are so numerous that this discipline appears to be a new concept that can only be applied correctly and effectively using sophisticated, high-tech equipment.

The aim of these articles is to develop this new concept for potential users and provide anyone already working with this equipment with explanations and data that will allow them, based on current knowledge and scientific work carried out, to optimise the use of their stimulators.

12.1.1 The fundamental law of electrostimulation

Electrostimulation is a technique which involves producing action potentials in the excitable cells (nerve and muscle) using an electric current.

Nerve cell membranes have a resting potential with an average value of -70mV , as the internal face of the membrane has negative polarity compared to the external face.

To excite the membrane of the nervous fibre, i.e. causing an action potential to appear at its surface, the resting potential simply has to be reduced to a certain threshold value, which is -50mV on average (Fig. 1). Once this threshold value has been reached the membrane changes from a state of rest to a state of activity. An action potential appears which then moves along the nerve fibre. The nerve impulse either goes towards the muscles to instruct them to contract or returns from the surrounding areas towards the brain to relay information regarding the senses.

Electrostimulating the nerve fibre essentially involves reducing the membrane's resting potential to the threshold value by applying an electric current to the skin.

The first question is, of course, which stimulating current to choose.

Which type of current will we use?

A single current must obviously be used, one which can reduce the resting potential to the threshold value but keep the patient as comfortable as possible. In other words, the electrical parameters of this current must be kept to a minimum, and its stimulation energy and duration must be as low as possible.

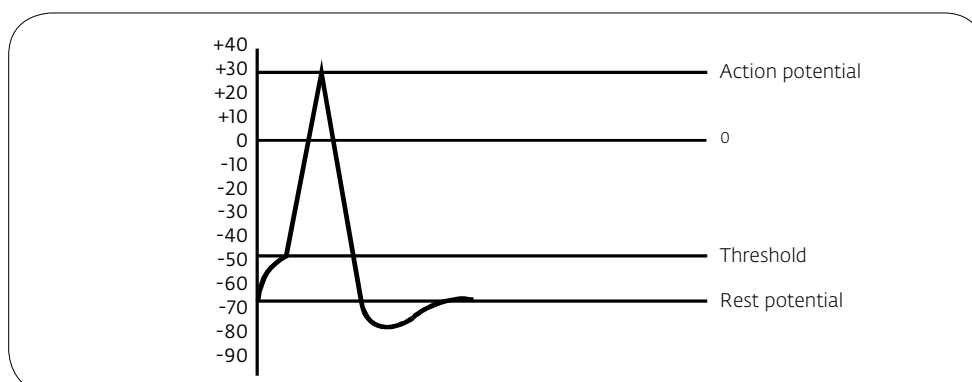

Fig. 1

12. ELECTROTHERAPY THEORY

We will therefore need to understand the fundamental law that it must observe in order to find the optimum qualities of this current.

This first chapter aims to provide a reminder and explanation of this law.

This is followed by a second chapter which, on the basis of this fundamental law and ideas surrounding it, determines the qualities of the optimum current.

At the turn of the last century, well-known physiologists such as Weiss, Hoorweg, Du Bois Reymond and Lapicque managed to discover the fundamental law of electrostimulation and its mathematical expression.

Based on Hoorweg's work, Weiss (a Parisian doctor and physiologist) emphasised the importance of the quantity of electrical charges created by the stimulation current. His experiments led to the fundamental observation that to achieve stimulation, it is not the type of current that is significant, but the quantity of current in a specified period of time. In other words, if the stimulation threshold values are given as a quantity of electricity (in electrical charges) that must be created to achieve these, the values are similar even if the electrical pulse with the same overall duration is a different shape.

As a reminder:

the quantity of electrical charges (Q) supplied by an electric current with intensity (I) in a given time (t) is the product of the intensity multiplied by the time.

$$Q = I \times t$$

Since the quantity of electrical charges provided by the stimulation current is the fundamental factor, Weiss studied the way in which the necessary quantity of charges is modified in order to achieve the threshold (i.e. to cause stimulation) based on the duration of the current being applied.

He performed a series of measures to determine the relationship between the quantity of current and the duration of the pulse for durations ranging from 0.23 to 3 ms.

From his experiments, Weiss found that there is a linear relationship between the quantity of charges required to reach the stimulation threshold and the duration of the pulse (Fig. 2).

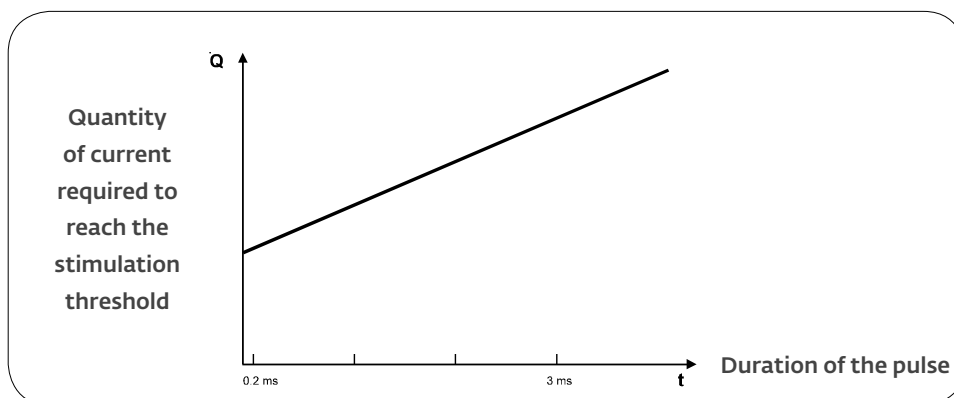

Linear relationship between the duration of the electrical pulse and the amount of electricity applied to reach the stimulation threshold:

$$Q = q + it$$

Fig. 2

12. ELECTROTHERAPY THEORY

Weiss therefore discovered the mathematical relationship that links the pulse duration with the amount of electricity required to produce the stimulation.

Understandably, he called this relationship the “fundamental formula”:

$$Q = q + it$$

Q = the amount of current required to reach the threshold. This is also the quantity of electrical charges provided by the stimulation current, as the Q value is given by the product ($I \times t$) of the stimulation current intensity multiplied by its application time.

t = length of time that the current is applied, which is known as the pulse duration.

i = a coefficient determined by experiment, with the same quantity as an electric current (intensity).

q = a coefficient determined by experiment, with the same dimensions as a quantity of electrical charges; q corresponds to the intersection of the straight line with the y-axis and may be calculated as the Q value when t is equal to zero.

Lapicque, an electrophysiologist who is more widely known than Weiss, did not actually discover a new law of electrostimulation but he performed a number of experiments which confirmed the fundamental formula. He defined it differently to mathematically deduce coefficients called the rheobase and chronaxy, which he gave physiological meaning.

Lapicque developed the “fundamental formula” as follows:

$$Q = q + it$$

$$\text{or } Q = It$$

I : stimulation current intensity

t : pulse duration

therefore $It = q + it$

by dividing the two by t , Lapicque obtained

$$I = q/t + i$$

which is the relationship between the intensity of the current and the time period in which it must be applied to achieve stimulation (Fig. 3).

12. ELECTROTHERAPY THEORY

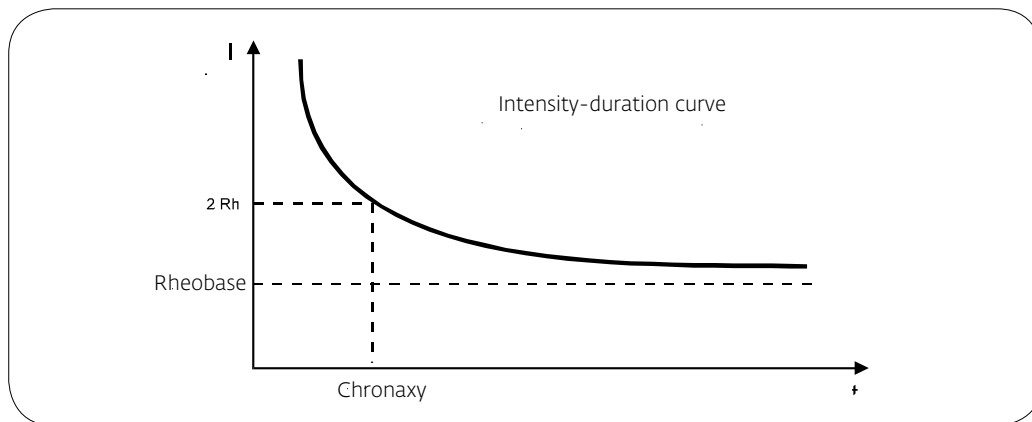

Hyperbolic relationship between the current intensity and pulse duration demonstrated by Lapicque and given by the formula $I = q/t + i$, derived from Weiss' fundamental formula.

Fig. 3

Lapicque's development also shows that, even when the length of time that the current is applied is infinite, ($t = \infty$), the current must have a minimum intensity known as the rheobase (Rh) in order to produce stimulation.

**if $t = \infty$ therefore $q/t = 0$
in this case I is the rheobase (Rh)
and $Rh = i$**

The rheobase, which is the minimum intensity that must be achieved in order to produce stimulation even if the pulse duration is very long, actually corresponds to the coefficient i of the Weiss formula which has dimensions of electrical intensity.

Lapicque gave the name chronaxy to the minimum length of time in which a current with double the intensity of the rheobase must be applied in order to achieve stimulation. In fact, he realised that the chronaxy is a time constant which characterises the excitability of tissue and that its value is the ratio q/i .

**This means that:
since $Rh = i$ when $I = 2 Rh$
therefore $I = 2 i$
and t is the chronaxy ($t ch$)
when $I = 2 Rh$
therefore from the equation $I = q/t + i$
the result is $2i = q/tch + i$
therefore $i = q/tch \rightarrow tch = q/i$**

12. ELECTROTHERAPY THEORY

We can note that the chronaxy can be calculated mathematically from Weiss' fundamental formula as shown in Figure 4.

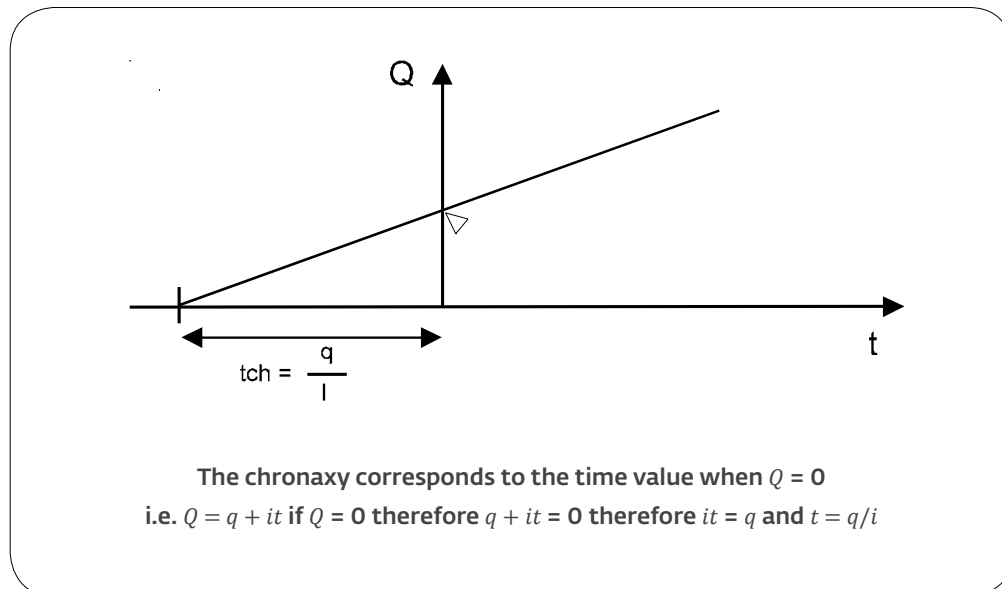

Fig. 4

12.1.2 Summary

Electrical stimulation, i.e. reducing resting potential to the stimulation threshold using an electric current, is a phenomenon that fulfils a fundamental physiological law.

This shows us that:

1 The factor determining stimulation is the quantity of electrical charges created by the current.

Stimulation must be considered in terms of the amount of current, which is the product ($I \times t$) of the intensity (I) times the duration of the pulse (t).

2 This amount of current fulfils a fundamental formula:

$$Q = q + it$$

where Q is a linear function of time.

Lapicque expresses this formula in another way by the "intensity - pulse duration" ratio: $I = q/t + i$ and he deduced that

a) the rheobase (Rh): minimum intensity that must be reached in order to produce stimulation using an infinite pulse duration

$$Rh = i$$

b) the chronaxy (tch): minimum time in which a current with double the intensity of that of the rheobase must be applied in order to produce stimulation

$$tch = q/i$$

12. ELECTROTHERAPY THEORY

12.1.3 References

1. Physiologie Volume II Le Système nerveux et Muscle Charles Kayser, ed. Flammarion
2. Lapique, L: Définition expérimentale de l'excitabilité Soc. Biologie 77 (1909), 280-283
3. Lapique, L: La Chronaxie et ses applications physiologiques Hermann & Cie, Paris, 1938
4. Weiss, G: Sur la possibilité de rendre comparable entre eux les appareils servant à l'excitation électrique
5. Arch. itali. Biol. 35 (1901), 413-446
6. Irnich, W: The chronaxy time and its practical importance Pace 3 (1980), 292-301
7. Cours de Physiologie Humaine Volume I Prof. Colin F. Université Libre de Bruxelles
8. Traité de Physiologie Médicale Arthur C. Guyton, ed. Doin
9. Physiologie Humaine Philippe Meyer 2nd edition Flammarion Médecine Science

12.2 The Optimum Current

12.2.1 Introduction

The reminders and ideas developed in the previous chapter, "The fundamental law of electrostimulation", must be read before starting this chapter, which describes the qualities of the optimum electrostimulation current.

The optimum current can be defined as being able to reduce the resting potential to the stimulation threshold value under Weiss' law, while also keeping the patient as comfortable as possible. The second requirement is met by minimising the electrical parameters of the stimulation current, i.e. by using a minimum amount of electrical intensity (I), pulse duration (t) and electrical energy (W).

Having set out the conditions, we will now determine the qualities of the current that fulfils these conditions.

12.2.2 Characteristics of the optimal current

12.2.2.1 Electrical stimulation wave produced by the current generator

We can already state that pulses of current, i.e. produced by a current generator, must be used for the following reasons:

- The first point shown by Weiss is the importance of the quantity of electrical charges provided by the stimulation current; however, the quantity of charges can only be controlled by a current generator.
- Only a current generator can ensure stable and reproducible conditions, given the variations in skin resistance.
- If a certain electrical pulse shape is required, only a current generator can maintain a constant current wave shape as it passes through the skin and tissue.

12. ELECTROTHERAPY THEORY

12.2.2.2 Type of establishment of the electrical stimulation wave

According to Weiss' law $Q = it + q$
 therefore $I t = it + q$
 therefore $(I - i) t = q$
 with $i = \text{rheobase}$
 i is a current which resists the stimulation current I

If the stimulation current I has a value lower than i (i.e. the rheobase), it cannot be used because it cannot change the resting potential by accumulating electrical charges in the excitable membrane (Fig. 1).

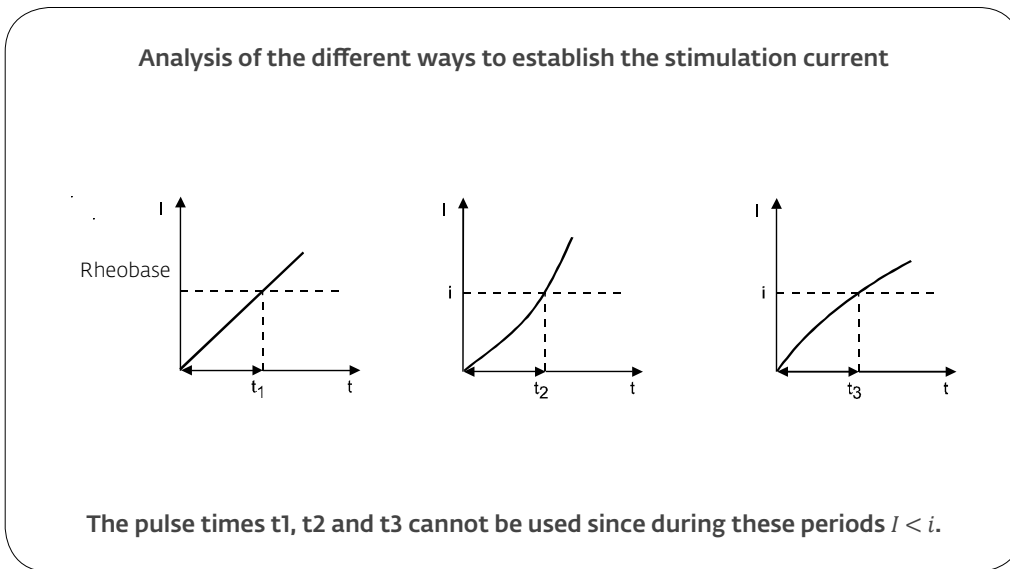

Fig. 1

Only one way of establishing the electrical stimulation wave is effective immediately, which is vertical (Fig. 2).

In this case, there is no delay in its efficacy and the duration of the electrical wave is further reduced by it.

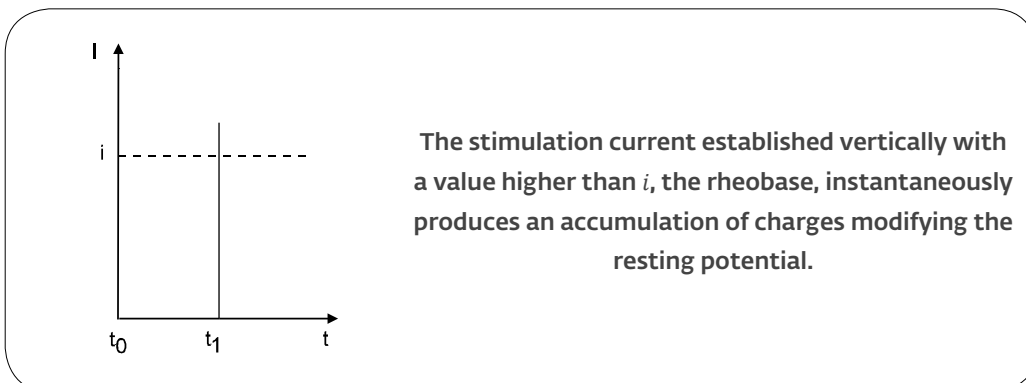

Fig. 2

12. ELECTROTHERAPY THEORY

12.2.2.3 Shape of the electrical stimulation wave

When the stimulation current has vertically reached an intensity higher than the rheobase, how should it develop in order to offer maximum comfort?

With minimum intensity, it must provide in time t the quantity of electrical charges

$Q = it + q$ required to trigger the action potential.

Since $Q = I.t.$, it is clear that the rectangle is the wave shape capable of providing the quantity of charges Q with minimum intensity I (Fig. 3).

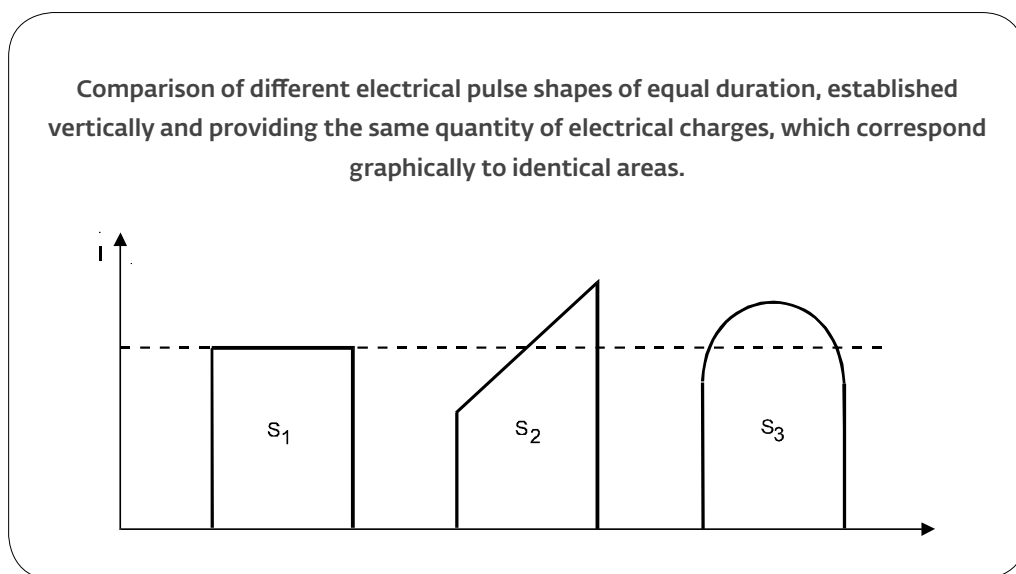

Fig. 3

In order to create the same quantity of charges with pulses with shapes other than rectangular, higher intensities must be used, which are as a result even less comfortable for the patient.

12. ELECTROTHERAPY THEORY

12.2.2.4 Duration of rectangular electrical pulse

First of all, it must be specified that this is in a specific pulse duration phase. Weiss' law is used for stimulation pulse durations close to the excitation constants k .

In the case of motor neurons, this means a time period ranging from 100 to 3,000 microseconds.

$$k = \text{Chronaxy} / \ln^2 = \text{Chronaxy} / 0,693$$

The third electrical factor, which should be minimised in order to produce the most comfortable possible stimulation, is electrical energy W .

We know that electrical energy is given by the formula $W = I^2 \cdot t \cdot R$, where:

I : is the current intensity

t : its pulse duration

R : the skin resistance

The Weiss or Lapicque relationship states

$$I = q/t + i$$

and we can replace I by its value in the energy equation.

We get $W = (q/t + i) t.R$.

by developing: $W = (q^2/t^2 + 2 i q/t + i^2) t.R = (q^2/t + 2 q i + i^2 t) R$.

When $t \rightarrow 0, W \rightarrow \infty$

When $t \rightarrow \infty, W \rightarrow \infty$

The shape of this curve is given in Figure 4.

Fig. 4

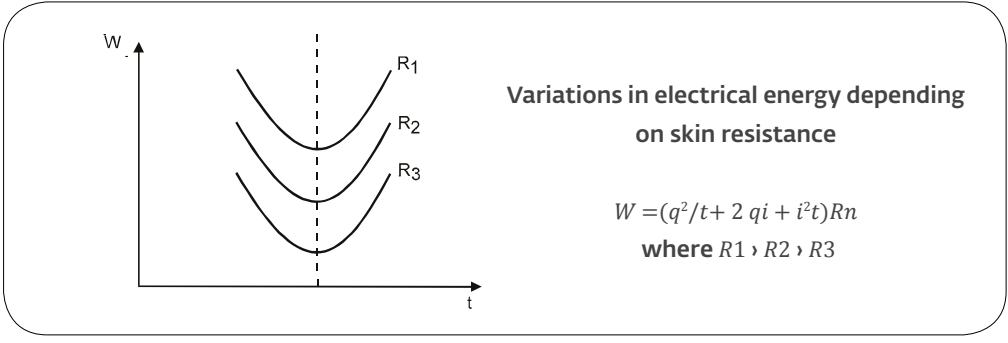
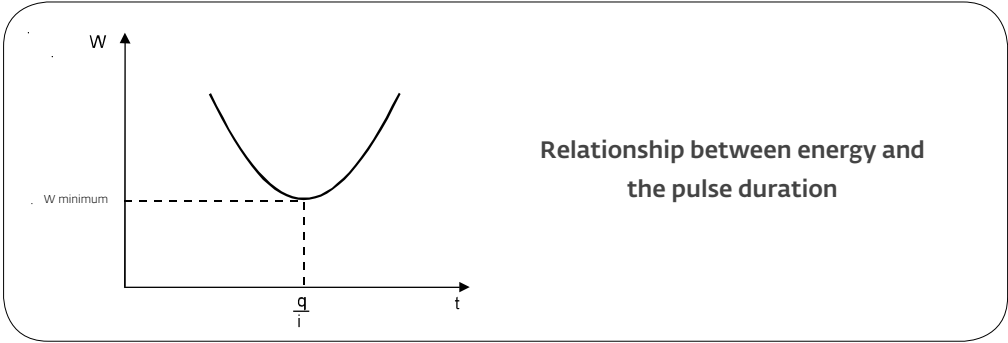

Fig. 5

12. ELECTROTHERAPY THEORY

The electrical energy passing through the skin and tissue is minimal for duration of the stimulation current, i.e. for a pulse duration, which is found by calculating the derivative of the energy curve at the minimum energy point (Fig. 6).

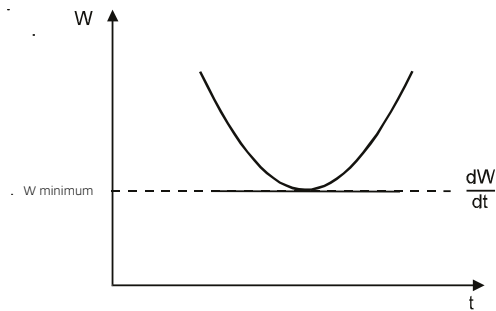

Fig. 6

The derivative of $W = (q^2/t + 2 q i + i^2 t) R$ is $dw/dt = (-q^2 t^2 + i^2) R$

The derivative is the slope of the tangent at any point of a curve.

As at the minimum energy point, this slope is at zero since it is parallel to the abscissa, we can therefore state that:

$$\text{for } W \text{ minimum } dw/dt = (-q^2 t^2 + i^2) R = 0 \text{ therefore } q^2 t^2 R = i^2 R - t^2 = q^2/i^2 - t = q/i$$

As we have seen above, R does not influence the determination of the pulse duration corresponding to the minimum energy.

The electrical energy passing through the skin and tissue is therefore minimum when the rectangular pulse duration is equal to q/i , which is in fact, as we have seen in the article on the fundamental law of electrostimulation, the chronaxy value.

Furthermore, this is why, at the start of the century, pioneers in electrophysiology chose the chronaxy as the value that characterises tissue excitability that is independent from variations in skin resistance.

To reduce electrical energy to its minimum, the rectangular pulse duration will therefore have to equal the chronaxy of the nerve structure that needs to be excited.

12. ELECTROTHERAPY THEORY

12.2.2.5 Compensation for the rectangular pulse

Every time stimulation needs to be produced, a rectangular pulse current is sent out, which has the same duration as the chronaxy of the nerve structure that needs to be stimulated. Repetition of stimulation is obtained by repeating the electrical impulse.

Whether this is with analgesic or motor stimulation electrotherapy, the stimulations correspond to a series of stimulations set by streams of pulses.

Repeating the pulses if they are not compensated for will result in polarisation, because the electrical mean is not zero (Fig. 7).

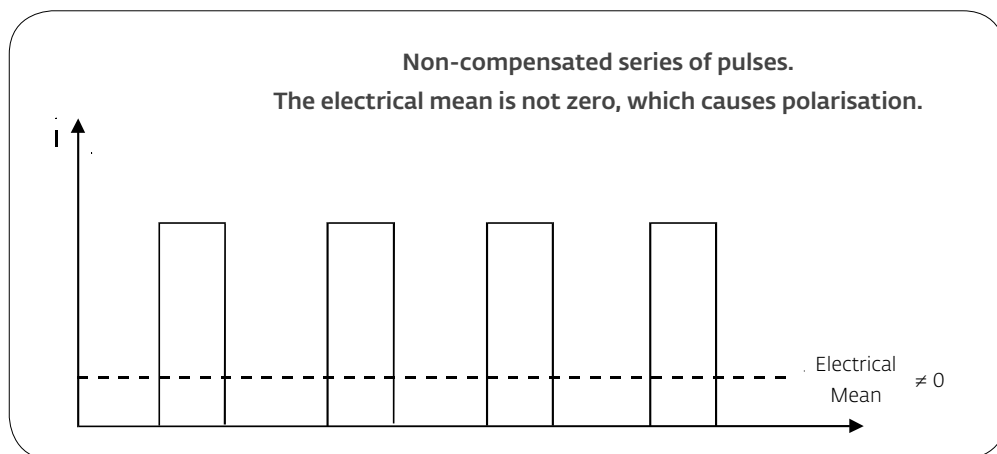

Fig. 7

The polarised current equates to a continuous current with a value equal to the mean intensity. Applying this kind of polarised current to the skin has the same disadvantages as a galvanic current, i.e. risk of skin burns in all cases, and sometimes ionisation if there is metal osteosynthetic material.

To resolve the issue of polarisation, the positive wave must be compensated for by a negative wave with the same quantity of electrical charge, i.e. the same area on the graph (Fig. 8). The electrical mean is therefore zero, the current is completely compensated for and the risks of polarisation are eliminated.

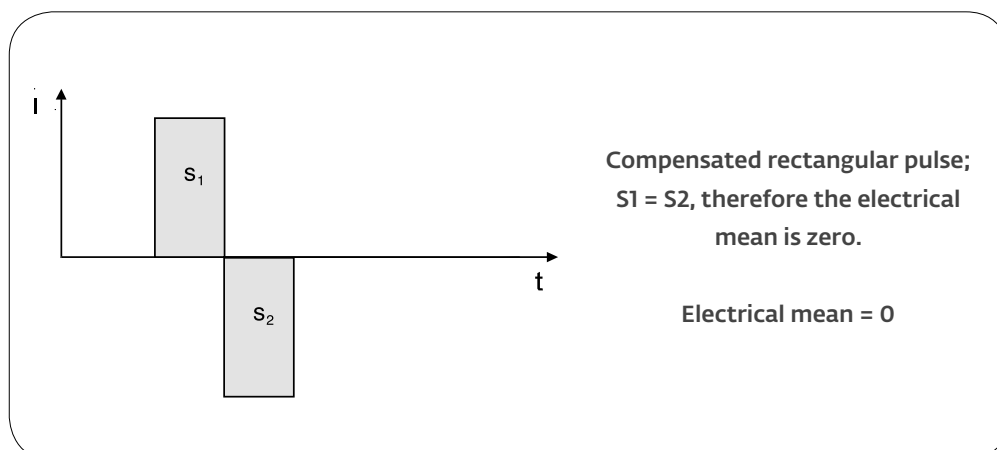

Fig. 8

12. ELECTROTHERAPY THEORY

12.2.3 Summary

The pulse current that is able to produce excitation (action potential) and also offer the patient the maximum amount of comfort can be called the optimum current.

This pulse must have the following characteristics:

1. **Constant pulses of current, i.e. produced by a constant current generator.**
2. **Vertical establishment in order to be effective immediately and to reduce the application time of the current.**
3. **Rectangular shape in order to apply the lowest possible electrical intensity.**
4. **Pulse duration that is equal to the chronaxy of the nerve structure requiring stimulation in order to minimise electrical energy.**
5. **Compensated pulse with an electrical mean of zero in order to prevent side effects linked to polarisation.**

12.3 Basic concepts of excitation electrophysiology

12.3.1 Introduction

Passing an electrical current through an excitable living tissue results in a change to the resting potential (V_0).

The changed resting potential is called the local potential (V).

If the variation in the local potential is sufficiently intense and in the right direction, a state of instability is reached and excitation, i.e. the action potential, occurs. The value that the local potential V must reach so that action potential appears is called the excitation threshold (S_0).

The local potential V , caused by electrical charges provided by the current passing through the excitable tissue (comparable to a neuron) returns to its initial value V_0 when the current is stopped. Returning to the resting conditions does not occur instantly but gradually, in the same way as discharging a capacitor. The mathematical law for the return of V to its initial rest value is:

$$-dV/dt=(V-V_0)/k \quad (1)$$

Where k has time dimensions and is the excitation time constant. The excitation time constant characterises the tendency of the local potential to return to its initial value at a particular speed when the neuron is no longer subjected to the current.

While the current is being passed, the local potential V does not increase instantly but exponentially, in the same way as the charge of a capacitor, with k as the time constant. This constant therefore defines the tendency of the neuron to oppose or resist the variation in potential caused by electrical charges provided by the stimulation current, which is identical to the charge of a capacitor.

12. ELECTROTHERAPY THEORY

It must be stated that k does not depend on the shape and qualities of the stimulation current; it is a feature of the neuron itself, which expresses the time factor of its tendency to return the membrane potential to the resting value.

The critical value that the local potential V must reach to trigger excitation, i.e. the excitation threshold S_0 , is only a constant value if the pulse duration is extremely short. If, however, the current lasts longer, the threshold increases (S). This phenomenon is demonstrated by the well-known fact that a current which increases slowly must reach a higher value in order to produce stimulation than a current which increases quickly.

The increase in the excitation threshold is known as accommodation. Accommodation is an increase in the threshold (S) which is the result of the change in the local potential caused by the electrical charges provided by the current passing through the neuron.

The increase in the threshold does not occur instantly but gradually and at a particular speed. A second time factor (λ) is therefore involved in the process of electrical excitation, which defines the rate at which the threshold changes (S).

When the local potential V is returned to its resting potential V_0 , S returns exponentially to its initial value. So with λ as the time constant according the mathematical law:

$$ds/dt = (S - S_0)/\lambda \quad (2)$$

This equation is for S what equation (1) is for V , with λ replacing k .

The electrical charges provided by the current passing through the neuron change the membrane potential. They produce a local potential V and this causes the threshold S to increase. Excitation occurs if a sufficient quantity of electrical charges is provided to allow the local potential to catch up with the threshold value, i.e. when $V = S$ (Fig. 1).

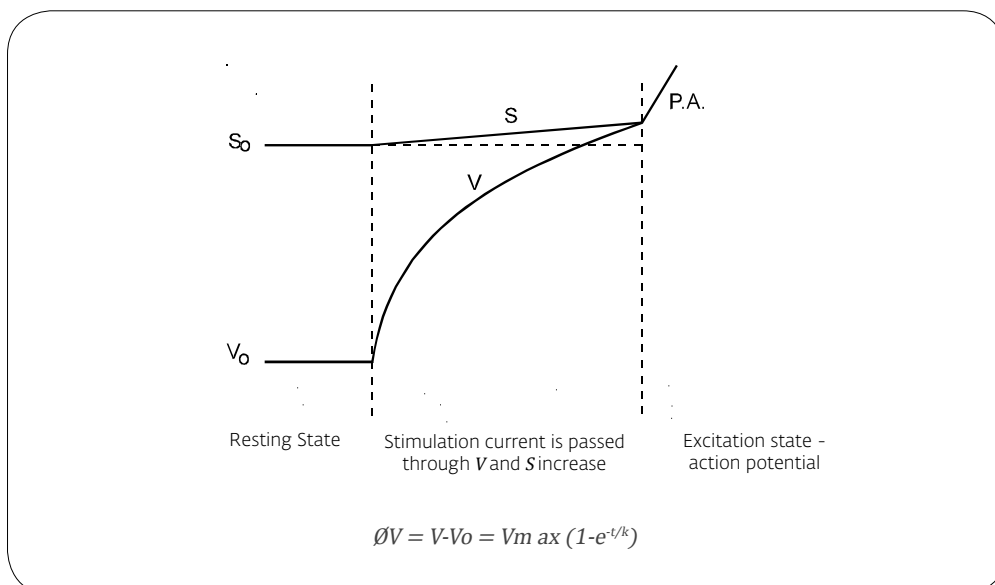

Fig. 1

12. ELECTROTHERAPY THEORY

The excitation process is therefore determined by two time constants:

k the excitation constant

λ the accommodation constant

These are independent from each other. This means that, to a large extent, λ can be modified by experiment separately to k , by changing the ionic concentration of Calcium (Ca). These two constants have values that are very different to each other, but λ is always much larger (100 to 200 times) than k . In the case of human motor neurons, approximate values of 300 μ s can be retained for k and 50 ms for λ . This means that k must be lower than λ for the excitation process to occur. The local potential (V) can therefore increase more quickly than the threshold S and catch up with it. If k were greater than λ , the threshold would increase more quickly than the local potential, which would never catch up with the threshold.

12.3.2 Study of the excitation process using a constant current

For the sake of simplicity, at this stage we will only study the excitation process produced by a constant current. The same study can be carried out using exponential, sinusoidal, linear, progressive, or any other type of current, as the results are similar.

For example, let us use the values:

$k = 1$ ms.

$\lambda = 50$ ms.

The issue in the excitation process is whether V will catch up with S or will S have time to escape.

The local potential V starts at V_0 and increases exponentially according to the relationship to a final value depending on the intensity of the current.

$$\Delta V = V - V_0 = V_{max} (1 - e^{-t/k})$$

The threshold S starts from S_0 and increases according to a more complicated curve, which can only be shown in part, and up to a value depending on the final stable value of V , if excitation has not occurred in the meantime.

In Figure 2a, the intensity of the current is set at a value (we will take as 1), which, without accommodation, would allow V to reach S_0 and to trigger excitation.

In fact V reaches the value S_0 but in the meantime the threshold increased, therefore $V = S_0 < S$ and excitation cannot occur.

To allow V to reach the value S , the current must be 8% more intense.

This is shown in Figure 2b, where the threshold has just been reached in 4 ms (indicated by the arrow), that is the principal useful time.

12. ELECTROTHERAPY THEORY

In Figure 2c, a stronger current with a value of 1.2 is applied and V passes the threshold after 1.85 ms. In Figure 2d, an even stronger current (value = 2) is applied and $V = S$ after 0.7 ms.

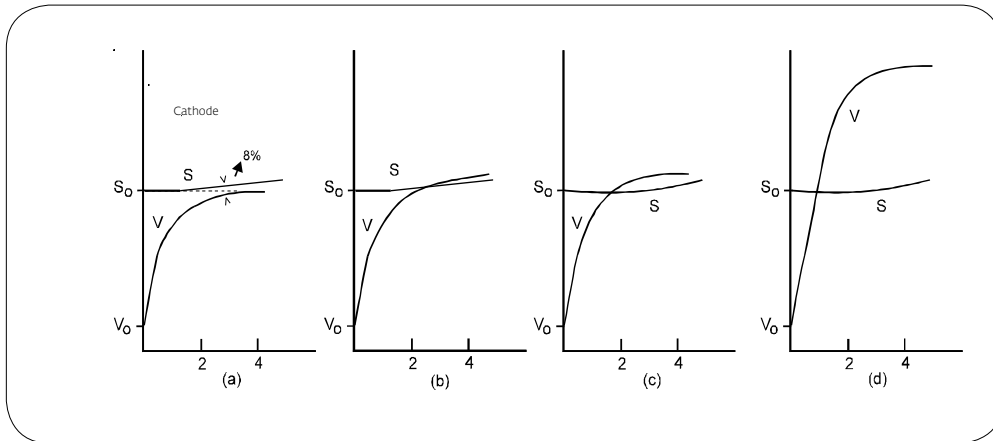

Fig. 2

We can therefore see the intensity-duration relationship appear, which gives the time at which V passes S for different current intensities. The useful times are even shorter when the current is more intense (Fig. 3).

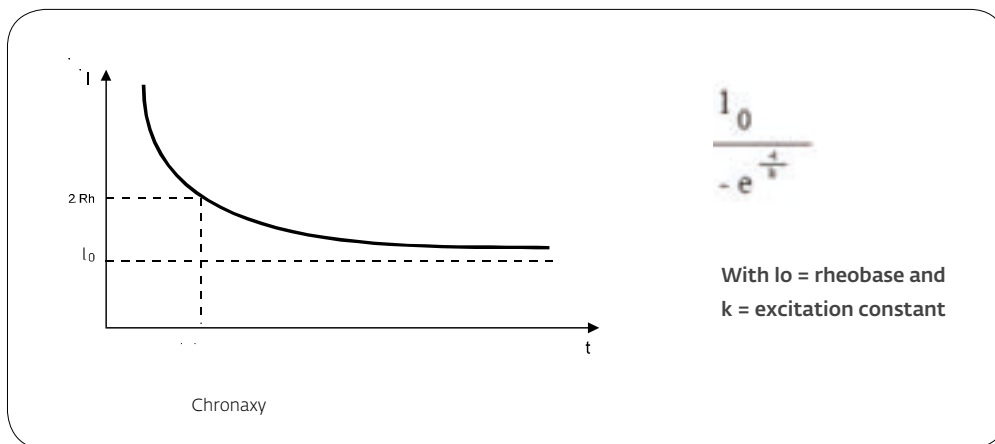

Fig. 3

This relationship applies to currents that are very short compared to the accommodation constant. Accommodation can be disregarded and excitation appears when $V = S_0$. This is why, in the intensity-duration relationship, only the excitation constant k occurs, as the duration of currents used have values close to k (from 0.2 ms to 3 ms).

12. ELECTROTHERAPY THEORY

If the durations of current applied were longer, the threshold would increase and excitation would only occur if V became equal to S. In these cases, the intensity-duration relationship must be reconsidered as the rheobase does not keep the value I_0 ; instead, it increases to a value $I_1 > I_0$ determined by the excitation and accommodation constants. The actual rheobase I_0 is linked to the observed rheobase I_1 by the relationship:

$$\frac{I_1}{I_0} = \left(\frac{\lambda}{k} \right)^{\frac{1}{k-1}}$$

12.3.3 Excitation by a current with any shape

It is possible to determine the equation for the local potential V and to calculate its value at any given point in time with any given shape of current.

An equation can also be determined for the development of the threshold.

These equations required a solid understanding of mathematics and come under the field of specialist electrophysiology. This is why we believe there is no purpose in expanding these equations as part of this work.

However, it can be noted that using these equations, which give the variation of V and , it is possible to study the excitation process with any given shape of current and for any given duration.

12.3.4 Chronaxy - excitation constant relationship

As the chronaxy is a value that characterises tissue excitability, it is worth determining the relationship which links it to the other factor that characterises excitation: k.

The chronaxy is the useful time corresponding to a stimulation current which has an intensity double that of the rheobase, i.e. $2 I_0$. It is therefore very easy to find the relationship between the chronaxy and the excitation constant based on the formula giving the intensity-duration relationship.

	$I = I_0 / (1 - e^{-t/\lambda})$
is the chronaxy	$I = 2I_0$
(tch) when	
therefore	$2I_0 = I_0 / (1 - e^{tch/k})$
	$2I_0 = (1 - e^{tch/k}) = I_0$
	$2(1 - e^{tch/k}) = 1$
	$2 - 2e^{tch/k} = 1$
	$2e^{tch/k} = 1$
	$e^{tch/k} = 1/2$
	$e^{1/tchk} = 1/2$
	$e^{tch/k} = 2$
	$1n2 = tch/k$
therefore	$t^{ch} = (1n2)k$
	This means that the chronaxy = 0.693

12. ELECTROTHERAPY THEORY

12.3.5 Hydraulic model of excitation

It is possible to set up a hydraulic model that corresponds exactly to excitation. This model allows a better understanding of excitation and may be used to represent the development of the local potential and the threshold under the effect of currents with variable durations and shapes

Water flows from tank A towards tank B by means of pump P, the stimulator (current generator). The flow of water corresponds to the intensity of the stimulation current and the water moved from A to B to the quantity of electrical charges. The water level in tank B reaches a certain level representing the value of the membrane potential (V_0 at rest and V local potential).

The stimulation threshold is given by a point D on float C. Stimulation occurs when level V in the tank B reaches point D by submerging the float.

When pump P injects liquid from A to B therefore increasing level V , part of the liquid goes back to A through tap K representing the excitation constant k . In the tank B, float C is linked to piston E that works by means of the level of liquid in tank F. This is linked to B by tap L representing the accommodation constant λ .

12. ELECTROTHERAPY THEORY

TWO EXAMPLES

A - Currents of long duration and low intensity

In order that level V reaches threshold D , a certain volume of water is necessary (likened to a certain quantity of electrical charges). If this water is supplied slowly by the pump (current of long duration and low intensity), some of the water has time to go through L and raise piston E therefore increasing the threshold level (accommodation). The quantity of liquid (the current) will therefore have to be greater because level V has to reach point D higher up. Moreover, a large amount of liquid returns from B to A through tap K . It is easy to understand that all these extra quantities that P has to transport indicate that we have an unfavourable stimulation current.

B - Currents of short duration and higher intensity

The durations intended here are close to the excitation constant value k .

In this case, as the flow is high, the pump action is short. As almost no liquid has gone through L , the float does not rise and accommodation is therefore negligible. Nevertheless, a certain quantity of water returns through K and has to be compensated for by P .

The Weiss law applies to these kinds of current (please refer to the fundamental law of electrostimulation).

$$Q = q + it \text{ or } It = q + it$$

Q is the total quantity of liquid provided by P with

I = intensity of the stimulation current

t = pulse duration

q is the volume of liquid separating V_0 from S_0 i.e. the quantity of charges that would have to be provided if there were no leak K . In other words, if the membrane potential varied instantaneously and not exponentially in accordance with a time constant K .

it the quantity of liquid that returns from B to A through tap K .

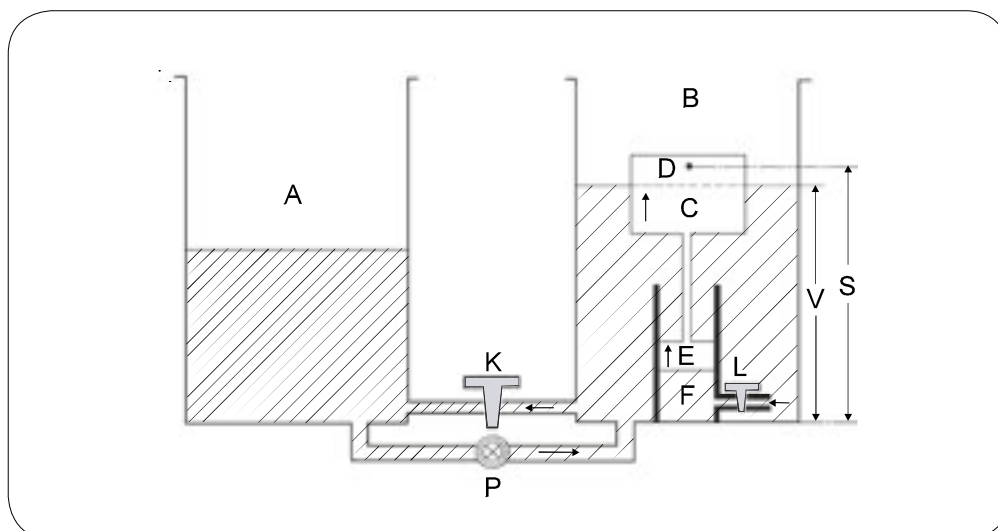

Fig. 4

13. AVAILABLE THERAPY PROGRAMS

13.1 Standard Version Programs and their usage

Within the Standard version treatment categories and their programs are:

REHABILITATION I	113
Treatment of disuse atrophy	113
Reinforcement	115
Prevention of disuse atrophy	117
Muscle lesion	119
Motor point (with motor point pen)	121

PAIN RELIEF I	122
TENS (Gate control) 100Hz	122
Frequency-modulated TENS	123
Pulse width modulated TENS	124
Endorphinic	125
Burst	127
Mixed Burst / TENS alternated	128
Decontracting	129

VASCULAR	131
Heavy legs	131
Venous insufficiency I	132
Venous insufficiency II	133
Arterial insufficiency I	134
Arterial insufficiency II	135
Cramp prevention	136
Capillarisation	137

CONDITIONING I	139
Resistance	139
Strength	141
Active recovery	143

FAVOURITES	
Programs upon individual settings	

13. AVAILABLE THERAPY PROGRAMS

13.1.1 Program category REHABILITATION I

CATEGORY	REHABILITATION
PROGRAM	TREATMENT OF DISUSE ATROPHY
WHEN?	A muscle that is normally innervated, after a period of immobilisation or diminished movement, rapidly decreases in volume. This decrease depends on the degree and duration of the functional deficit. Slow fibres (type I) in particular are affected by disuse atrophy.
WHY?	To reactivate the trophicity of the muscle fibres altered during disuse atrophy. To reverse muscle wastage.
HOW?	By using frequencies creating a tetanic contraction in type I fibres to impose a significant workload on the atrophied muscle, so that it recovers volume. Recovery therefore takes place far more quickly than by simply using muscle activities.
PULSE WIDTH	To make it as comfortable as possible for the patient, use pulse widths equivalent to the chronaxies of the motor nerves of the muscles being stimulated. The mi-SCAN can be used to determine the pulse widths suitable for the patient's muscles.
ELECTRODES	Electrodes positioned depending on the muscle to be stimulated, in accordance with the instructions.
INTENSITY	Use the maximum stimulation energies. The first and second sessions help the patient become accustomed to the method by gradually increasing the stimulation energy every 3 or 4 contractions. In the following sessions, it is important to support the patient's progress by setting targets which go beyond the energy levels reached in the previous session.
+TENS OPTION	<p>Yes.</p> <ul style="list-style-type: none"> - A minimum of 1 channel with muscular work imposed by the Disuse atrophy programme. - A maximum of 3 channels with the TENS programme. <ul style="list-style-type: none"> • Electrodes positioned on the painful area. • Sufficient stimulation energy to produce a clear tingling sensation. <p>Once the +TENS combination has been activated, the message "TENS" appears on the screen with respect to the channel or channels where the treatment is active. The mi functions – apart from the mi-SCAN – are also no longer accessible.</p> <p>Take care to properly observe the correct order for switching on the modules, the order of switching on that corresponds to the numbering of the channels.</p>

13. AVAILABLE THERAPY PROGRAMS

DISUSE ATROPHY, LEVEL 1 (25 MIN)				
	WARM UP	CONTRACTION	ACTIVE REST	FINAL RECOVERY PHASE
FREQUENCY	6 Hz	35 Hz	4 Hz	3 Hz
DURATION OF RAMP-UP	1.5 s	1.5 s	0.5 s	1.5 s
DURATION OF PHASE	2 min	6 s	7 s	3 min
DURATION OF RAMP-DOWN	2 s	0.75 s	0.5 s	3 s

DISUSE ATROPHY, LEVEL 2 (25 MIN)				
	WARM UP	CONTRACTION	ACTIVE REST	FINAL RECOVERY PHASE
FREQUENCY	6 Hz	45 Hz	4 Hz	3 Hz
DURATION OF RAMP-UP	1.5 s	1.5 s	0.5 s	1.5 s
DURATION OF PHASE	2 min	6 s	5 s	3 min
DURATION OF RAMP-DOWN	2 s	0.75 s	0.5 s	3 s

13. AVAILABLE THERAPY PROGRAMS

CATEGORY	REHABILITATION
PROGRAM	REINFORCEMENT
WHEN?	For use either on previously atrophied muscles which have regained their volume as a result of electrostimulation through disuse atrophy treatment programmes, or as a first-line on non- atrophied muscles which have lost their strength and speed of contraction.
WHY?	To restore the strength of the contraction in the case of muscle insufficiency without pronounced disuse atrophy or after restoration of muscle volume.
HOW?	By using frequencies creating a tetanic contraction in the quick fibres (type IIb), which are the strength and speed fibres.
PULSE WIDTH	To make it as comfortable as possible for the patient, use pulse widths equivalent to the chronaxies of the motor nerves of the muscles being stimulated. The mi-SCAN function can be used to determine the pulse widths suitable for the patient's muscles.
ELECTRODES	Electrodes positioned depending on the muscle to be stimulated, in accordance with the instructions.
INTENSITY	Use the maximum stimulation energies. The first and second sessions help the patient become accustomed to the method by gradually increasing the stimulation energy every 3 or 4 contractions. In the following sessions, it is important to support the patient's progress by setting targets which go beyond the energy levels reached in the previous session.
+TENS OPTION	<p>Yes.</p> <ul style="list-style-type: none"> - A minimum of 1 channel with muscular work imposed by the Disuse atrophy programme. - A maximum of 3 channels with the TENS programme. <ul style="list-style-type: none"> • Electrodes positioned on the painful area. • Sufficient stimulation energy to produce a clear tingling sensation. <p>Once the +TENS combination has been activated, the message "TENS" appears on the screen with respect to the channel or channels where the treatment is active. The mi functions – apart from the mi-SCAN – are also no longer accessible.</p> <p>Take care to properly observe the correct order for switching on the modules, the order of switching on that corresponds to the numbering of the channels.</p>

13. AVAILABLE THERAPY PROGRAMS

REINFORCEMENT, LEVEL 1 (20 MIN)				
	WARM UP	CONTRACTION	ACTIVE REST	FINAL RECOVERY PHASE
FREQUENCY	6 Hz	75 Hz	4 Hz	3 Hz
DURATION OF RAMP-UP	1.5 s	1.5 s	0.5 s	1.5 s
DURATION OF PHASE	2 min	4 s	10 s	3 min
DURATION OF RAMP-DOWN	2 s	0.75 s	0.5 s	3 s

REINFORCEMENT, LEVEL 2 (20 MIN)				
	WARM UP	CONTRACTION	ACTIVE REST	FINAL RECOVERY PHASE
FREQUENCY	6 Hz	85 Hz	4 Hz	3 Hz
DURATION OF RAMP-UP	1.5 s	1.5 s	0.5 s	1.5 s
DURATION OF PHASE	2 min	4 s	8 s	3 min
DURATION OF RAMP-DOWN	2 s	0.75 s	0.5 s	3 s

13. AVAILABLE THERAPY PROGRAMS

CATEGORY	REHABILITATION
PROGRAM	PREVENTION OF DISUSE ATROPHY
WHEN?	After an operation or a bone fracture, a limb or a section of a limb is immobilised, the muscles of this part of the body are affected very quickly by disuse atrophy. This rapid decrease in muscle volume is mainly due to reflex inhibition and a total absence of muscle activity. It is also important to note that disuse atrophy tends to disproportionately affect type I fibres more than type II.
WHY?	To compensate for total or partial inactivity of the muscle following an osteoarticular injury.
HOW?	In order to prevent disuse atrophy, electrostimulation has to compensate for the total inactivity of the muscle by reproducing a series of contractions similar to the different ways in which the muscle functions when it is working normally. The main treatment phases are carried out with conventional operational frequencies for slow fibres to compensate for their tendency towards disuse atrophy.
PULSE WIDTH	To make it as comfortable as possible for the patient, use pulse widths equivalent to the chronaxies of the motor nerves of the muscles being stimulated. The mi-SCAN function can be used to determine the pulse widths suitable for the patient's muscles.
ELECTRODES	Electrodes positioned depending on the muscle to be stimulated, in accordance with the instructions.
INTENSITY	Use the maximum stimulation energies. The first and second sessions help the patient become accustomed to the method by gradually increasing the stimulation energy every 3 or 4 contractions. In the following sessions, it is important to support the patient's progress by setting targets which go beyond the energy levels reached in the previous session.
+TENS OPTION	<p>Yes.</p> <ul style="list-style-type: none"> - A minimum of 1 channel with muscular work imposed by the Disuse atrophy programme. - A maximum of 3 channels with the TENS programme. <ul style="list-style-type: none"> • Electrodes positioned on the painful area. • Sufficient stimulation energy to produce a clear tingling sensation. <p>Once the +TENS combination has been activated, the message "TENS" appears on the screen with respect to the channel or channels where the treatment is active. The mi functions – apart from the mi-SCAN – are also no longer accessible.</p> <p>Take care to properly observe the correct order for switching on the modules, the order of switching on that corresponds to the numbering of the channels.</p>

13. AVAILABLE THERAPY PROGRAMS

PREVENTION OF DISUSE ATROPHY, LEVEL 1 (54 MIN)				
	WARM UP	CONTRACTION	ACTIVE REST	FINAL RECOVERY PHASE
FREQUENCY	6 Hz	30 Hz	4 Hz	3 Hz
DURATION OF RAMP-UP	1.5 s	3 s	1.5 s	1.5 s
DURATION OF PHASE	2 min	5 s	14 s	3 min
DURATION OF RAMP-DOWN	2 s	1.5 s	1.5 s	3 s

PREVENTION OF DISUSE ATROPHY, LEVEL 2 (47 MIN)				
	WARM UP	CONTRACTION	ACTIVE REST	FINAL RECOVERY PHASE
FREQUENCY	6 Hz	40 Hz	4 Hz	3 Hz
DURATION OF RAMP-UP	1.5 s	3 s	0.5 s	1.5 s
DURATION OF PHASE	2 min	6 s	12 s	3 min
DURATION OF RAMP-DOWN	2 s	0.75 s	0.5 s	3 s

13. AVAILABLE THERAPY PROGRAMS

CATEGORY	REHABILITATION
PROGRAM	MUSCLE LESION
WHEN?	It is well known that early but well-controlled muscle work has a positive impact on the scarring process of the muscle fibres and the connective supporting tissues. The Muscle Lesion programme can be used as soon as the scar begins to form and is considered satisfactory, but as a general rule not until the 10th day after the initial lesion.
WHY?	To direct and speed up the scarring process and prevent disuse atrophy. To enable the patient to return to sport more quickly.
HOW?	The muscle lesion programme is designed to cause extremely gradual muscle contractions using a rate of tensioning 4 times longer than for standard programmes. This aims to reduce the risk of adverse secondary ruptures.
PULSE WIDTH	To make it as comfortable as possible for the patient, use pulse widths equivalent to the chronaxies of the motor nerves of the muscles being stimulated. The mi-SCAN function can be used to determine the pulse widths suitable for the patient's muscles.
ELECTRODES	Electrodes positioned depending on the muscle to be stimulated, in accordance with the instructions.
INTENSITY	Use the maximum stimulation energies. The first and second sessions help the patient become accustomed to the method by gradually increasing the stimulation energy every 3 or 4 contractions. In the following sessions, it is important to support the patient's progress by setting targets which go beyond the energy levels reached in the previous session.
+TENS OPTION	<p>Yes.</p> <ul style="list-style-type: none"> - A minimum of 1 channel with muscular work imposed by the Disuse atrophy programme. - A maximum of 3 channels with the TENS programme. <ul style="list-style-type: none"> • Electrodes positioned on the painful area. • Sufficient stimulation energy to produce a clear tingling sensation. <p>Once the +TENS combination has been activated, the message "TENS" appears on the screen with respect to the channel or channels where the treatment is active. The mi functions – apart from the mi-SCAN – are also no longer accessible.</p> <p>Take care to properly observe the correct order for switching on the modules, the order of switching on that corresponds to the numbering of the channels.</p>

13. AVAILABLE THERAPY PROGRAMS

MUSCLE LESION (30 MIN)				
	WARM UP	CONTRACTION	ACTIVE REST	FINAL RECOVERY PHASE
FREQUENCY	6 Hz	40 Hz	4 Hz	3 Hz
DURATION OF RAMP-UP	1.5 s	6 s	1.5 s	1.5 s
DURATION OF PHASE	2 min	3 s	10 s	3 min
DURATION OF RAMP-DOWN	2 s	1.5 s	1.5 s	3 s

13. AVAILABLE THERAPY PROGRAMS

CATEGORY	REHABILITATION
PROGRAM	MOTOR POINT
WHEN?	It is advisable to use this programme before all initial muscle electrostimulation sessions in order to precisely locate the motor points for each person. Locating the motor points is recommended especially for long muscles, such as those in the lower limbs (quadriceps, etc.).
WHY?	In order to guarantee optimum effectiveness of the programmes.
HOW?	A motor point pen must be used to locate the motor points. See the example on the section on specific indications.

MOTOR POINT (15 MIN)	
	CONTINUOUS STIMULATION
FREQUENCY	3 Hz

13. AVAILABLE THERAPY PROGRAMS

13.1.2 Program category PAIN RELIEF

CATEGORY	PAIN RELIEF
PROGRAM	100 Hz TENS OR FREQUENCY-MODULATED TENS
WHEN?	Gate control, which is activated during TENS stimulation, is particularly effective for the relief of localised pain of non-muscular origin. It is particularly effective for relieving neuropathic pain and inflammatory conditions. The sessions may be repeated at will and without restriction, depending upon the intensity of the pain.
WHY?	Pain relief is now a priority in therapy which must be provided by all healthcare professionals. As TENS treatment is generally palliative, it improves the patient's comfort and helps the therapist to start the process.
HOW?	The principle is to cause a significant influx of tactile sensitivity in order to restrict the entry of pain impulses upon their return to the posterior horn of the spinal cord. We must therefore stimulate the sensitivity fibres on the skin of the painful area. To do this, it is necessary to use a frequency that is the same as the operational frequencies for the tactile sensitivity nerve fibres, i.e. from 50 to 150 Hz.
PULSE WIDTH	Use very short pulse widths corresponding to the chronaxies of the tactile sensitivity fibres, i.e. 30, 50 or 70 μ s, depending on whether the patient is very sensitive, normal, or not very sensitive (level 1, 2 or 3 respectively).
ELECTRODES	As a general rule, the electrodes are placed on or near the painful area. The electrodes may also be placed at the nerve trunks depending on the conditions being treated.
INTENSITY	The intensity must be increased gradually until the patient perceives a tingling sensation that is pronounced without being painful. Acclimatisation is normal if a non-modulated TENS programme is used. In this case, it is advisable to slightly increase the stimulation energies on a regular basis so that the patient continues to feel a tingling sensation. The mi-TENS function prevents any kind of muscle contraction. If the sensor detects a muscle response, the stimulator automatically reduces the stimulation energy in order to stop the muscle response.
+TENS OPTION	No.

13. AVAILABLE THERAPY PROGRAMS

TENS			
FREQUENCY	LEVEL	PULSE WIDTH	TREATMENT TIME
100 Hz	1	30 μ s	20 min
100 Hz	2	50 μ s	20 min
100 Hz	3	70 μ s	20 min

FREQUENCY MODULATED TENS				
FREQUENCY	LEVEL	PULSE WIDTH	MODULATION TIME	TREATMENT TIME
50-150 Hz	1	30 μ s	2 s	20 min
50-150 Hz	2	50 μ s	2 s	20 min
50-150 Hz	3	70 μ s	2 s	20 min

13. AVAILABLE THERAPY PROGRAMS

CATEGORY	PAIN RELIEF
PROGRAM	PULSE WIDTH MODULATED TENS
WHEN?	Gate control, which is activated during TENS stimulation, is particularly effective for the relief of localised pain of non-muscular origin. It is particularly effective for relieving neuropathic pain and inflammatory conditions. The sessions may be repeated at will and without restriction, depending upon the intensity of the pain.
WHY?	Pain relief is now a priority in therapy which must be provided by all healthcare professionals. As TENS treatment is generally palliative, it improves the patient's comfort and helps the therapist to start the process.
HOW?	The principle is to cause a significant influx of tactile sensitivity in order to restrict the entry of pain impulses upon their return to the posterior horn of the spinal cord. We must therefore stimulate the sensitivity fibres on the skin of the painful area. To do this, it is necessary to use a frequency that is the same as the operational frequencies for the tactile sensitivity nerve fibres, i.e. from 50 to 150 Hz.
PULSE WIDTH	The pulse width varies continuously with this programme. This avoids habituation by using a system of stimulation that is perceived as more pleasant by some patients.
ELECTRODES	As a general rule, the electrodes are placed on or near the painful area. The electrodes may also be placed at the nerve trunks depending on the conditions being treated.
INTENSITY	The intensity must be increased gradually until the patient perceives a tingling sensation that is pronounced without being painful.
+TENS OPTION	No.

PULSE WIDTH MODULATED TENS			
FREQUENCY	PULSE WIDTH	MODULATION TIME	TREATMENT TIME
80 Hz	70-180 μ s	2 s	30 min

13. AVAILABLE THERAPY PROGRAMS

CATEGORY	PAIN RELIEF
PROGRAM	ENDORPHINIC
WHEN?	An increase in the tension of the contracted muscle fibres and the crushing of the capillary network resulting from this causes a decrease in the blood flow and a gradual accumulation of acid metabolites and free radicals. Without treatment, there is a risk that the contracture will become chronic and genuine atrophy of the capillary network may gradually occur.
WHY?	To relieve chronic muscle pain.
HOW?	Studying publications about reducing pain by increasing endorphin production shows that the pulses have to be large enough to excite type A δ nerve fibres as well as type A α , which is shown by the production of muscle twitches. The effects of endorphinic stimulation are described for frequencies between 2 and 8 Hz. In addition to the general effect of increasing endorphin production in the hypothalamus, which elevates the pain perception threshold, there is a very significant localised effect. The 5 muscle twitches induced every second by stimulation produce very significant hyperaemia, which drains the acid metabolites and free radicals that had accumulated in the chronically contracted muscle areas.
PULSE WIDTH	Endorphinic stimulation is primarily aimed at the sensitive A δ nerve fibres which are best stimulated with pulse width of 200 μ s. However the vascular effect is secondary to the co- activation of the motor units, which have a slightly higher chronaxy that is measured at the start of the session using the mi-SCAN function.
ELECTRODES	Electrodes must be placed after a thorough palpatory examination to locate the most painful point, where a small electrode preferably connected to the positive pole of the cable will be placed. The other electrode is placed at the end of muscle or muscle group being stimulated.
INTENSITY	An essential factor in the therapeutic efficacy is to cause visible muscle twitching, which may, in certain cases, require higher stimulation energies to be used. The mi-RANGE function can be used to determine the minimum level of energy required to produce an appropriate muscle response.

13. AVAILABLE THERAPY PROGRAMS

CATEGORY	PAIN RELIEF
+TENS OPTION	<p>Yes.</p> <ul style="list-style-type: none"> - A minimum of 1 channel with muscular work imposed by the Disuse atrophy programme. - A maximum of 3 channels with the TENS programme. <ul style="list-style-type: none"> • Electrodes positioned on the painful area. • Sufficient stimulation energy to produce a clear tingling sensation. <p>Once the +TENS combination has been activated, the message "TENS" appears on the screen with respect to the channel or channels where the treatment is active. The mi functions – apart from the mi-SCAN – are also no longer accessible.</p> <p>Take care to properly observe the correct order for switching on the modules, the order of switching on that corresponds to the numbering of the channels.</p>

ENDORPHINIC		
FREQUENCY	PULSE WIDTH	TREATMENT TIME
5 Hz	200 µs	20 min

13. AVAILABLE THERAPY PROGRAMS

CATEGORY	PAIN RELIEF
PROGRAM	BURST
WHEN?	The Burst programme is an type of endorphinic programme, which has a less pronounced vascular effect than endorphinic. It may be used in the same way to relieve pain following a chronic contracture.
WHY?	To relieve chronic muscle pain.
HOW?	The Burst mode involves replacing the emission of an isolated electric pulse by an emission of a very short burst of 8 pulses. In this way, the Burst programme emits 2 burst per second, which can produce the same endorphinic results as for a standard frequency of 2 Hz.
PULSE WIDTH	The pulse width for the programme is 180 μ s.
ELECTRODES	Electrodes must be placed after a thorough palpatory examination to locate the most painful point, where a small electrode preferably connected to the positive pole of the cable will be placed. The other electrode is placed at the end of muscle or muscle group being stimulated.
INTENSITY	An essential factor in the therapeutic efficacy is to cause visible muscle twitching, which may, in certain cases, require higher stimulation energies to be used.
+TENS OPTION	No.

BURST TENS		
FREQUENCY	PULSE WIDTH	TREATMENT TIME
2 Hz (2 pulse trains per second with an internal frequency of 80 Hz)	180 μ s	20 min

13. AVAILABLE THERAPY PROGRAMS

CATEGORY	PAIN RELIEF
PROGRAM	MIXED BURST / TENS ALTERNATED
WHEN?	Described by Han, modulated stimulation Burst TENS successively activates (every 3 seconds) the Gate control mechanism and releases endogenous opioid substances. This is a therapeutic option, which may be worth considering for poorly classified pain with multiple causes.
WHY?	To improve the patient's comfort and to enable the therapist to start the process more easily.
HOW?	Burst-modulated TENS is based on the Gate control theory (TENS effect) and on the release of morphine-like substances produced by the body, endorphins (Endorphinic effect). The stimulation frequencies vary every 3 seconds, producing a combined stimulation of 80 Hz and 2 Hz.
PULSE WIDTH	The pulse width for the programme is 180 µs.
ELECTRODES	As a general rule, the electrodes are placed on or near the painful area.
INTENSITY	The stimulation should produce a sharp but pleasant tingling sensation and visible muscle twitches. Please note: This programme has two distinct energy levels. First adjust the intensity level for 80 Hz (TENS) until a tingling sensation is felt, then repeat the procedure for 2 Hz (endorphinic) in order to produce visible muscle twitches.
+TENS OPTION	No.

MIXED TENS		
FREQUENCY	PULSE WIDTH	TREATMENT TIME
80 Hz 3 s / 2 Hz 3 s	180 µs	30 min

13. AVAILABLE THERAPY PROGRAMS

CATEGORY	PAIN RELIEF
PROGRAM	DECONTRACTURING
WHEN?	This type of treatment is indicated to relieve pain following acute muscle contractures (torticollis, lumbago, etc.). It will also reduce muscle tension in the contracted muscles to facilitate manual handling techniques.
WHY?	To decrease muscle tension.
HOW?	Current experiments show that muscles twitches caused by a very low frequency of 1 Hz can effectively remove contractures or decrease resting muscle tension of the stimulated muscle.
PULSE WIDTH	To make it as comfortable as possible for the patient, use pulse widths equivalent to the chronaxies of the motor nerves of the muscles being stimulated. The mi-SCAN function can be used to determine the pulse widths suitable for the patient's muscles.
ELECTRODES	Electrodes must be placed after a thorough palpatory examination to locate the most painful point, where a small electrode preferably connected to the positive pole of the cable will be placed. The other electrode is placed at the end of muscle or muscle group being stimulated. If a contracture affects all the muscle fibres, the electrodes suitable for neuromuscular stimulation can also be applied (please refer to the positions recommended for the muscle being stimulated).
INTENSITY	An essential factor in the therapeutic efficacy is to cause visible muscle twitching, which may, in certain cases, require higher stimulation energies to be used. The mi-RANGE function can be used to determine the minimum level of energy required to produce an appropriate muscle response.
+TENS OPTION	<p>Yes.</p> <ul style="list-style-type: none"> - A minimum of 1 channel with muscular work imposed by the Disuse atrophy programme. - A maximum of 3 channels with the TENS programme. <ul style="list-style-type: none"> • Electrodes positioned on the painful area. • Sufficient stimulation energy to produce a clear tingling sensation. <p>Once the +TENS combination has been activated, the message "TENS" appears on the screen with respect to the channel or channels where the treatment is active. The mi functions – apart from the mi-SCAN – are also no longer accessible.</p> <p>Take care to properly observe the correct order for switching on the modules, the order of switching on that corresponds to the numbering of the channels.</p>

13. AVAILABLE THERAPY PROGRAMS

DECONTRACTION	
FREQUENCY	TREATMENT TIME
1 Hz	20 min

13. AVAILABLE THERAPY PROGRAMS

13.1.3 Program category VASCULAR

CATEGORY	VASCULAR
PROGRAM	HEAVY LEGS
WHEN?	The problem of “heavy legs” occurs when venous blood return sometimes does not take place, but does not cause any damage to the body. Heat, certain stages of the menstrual cycle, prolonged standing and long continuous periods sitting down may cause swelling (stasis oedema) with a considerable feeling of heaviness in the lower limbs. A certain degree of muscle tension is often associated with this, and female patients can experience cramps in their calves.
WHY?	To accelerate venous blood return, re-oxygenate the tissues and produce a relaxing effect.
HOW?	During the treatment session, we move progressively and automatically through a series of clearly defined frequencies, requiring a large increase in the flow to allow acceleration of the venous blood return (7 Hz), produce an analgesic effect by increasing the production of endorphins (5 Hz) and end by relaxing the muscles (3 Hz), while keeping the blood flow noticeably high.
PULSE WIDTH	To make it as comfortable as possible for the patient, use pulse widths equivalent to the chronaxies of the motor nerves of the calf muscles. The mi-SCAN function can be used to determine the pulse widths suitable for the patient’s muscles.
ELECTRODES	A large electrode is placed transversely under the popliteal fossa and two small electrodes are positioned on the contour of the gastrocnemius muscles.
INTENSITY	An essential factor in the effectiveness of electrotherapy is the ability to cause visible muscle twitches. The mi-RANGE function can be used to determine the minimum level of energy required to produce an appropriate muscle response.
+TENS OPTION	No.

TENS			
	1ST SEQUENCE	2ND SEQUENCE	3RD SEQUENCE
FREQUENCY	7 Hz	5 Hz	3 Hz
DURATION OF RAMP-UP	1.5 s	1 s	1 s
DURATION OF PHASE	7 min	7 min	7 min
DURATION OF RAMP-DOWN	0.5 s	0.5 s	6 s

13. AVAILABLE THERAPY PROGRAMS

CATEGORY	VASCULAR
PROGRAM	VENOUS INSUFFICIENCY 1
WHEN?	In the event of venous insufficiency without oedema.
WHY?	To increase the general blood flow so as to improve the circulation of the interstitial fluid and increase oxygenation of the tissues and the intima of the veins. To drain the veins as much as possible in order to combat stasis.
HOW?	Send pulses so as to cause short tetanic contractions (to drain the deep veins), separated by long periods to increase the flow.
PULSE WIDTH	To make it as comfortable as possible for the patient, use pulse widths equivalent to the chronaxies of the motor nerves of the muscles being stimulated. The mi-SCAN function can be used to determine the pulse widths suitable for the patient's muscles.
ELECTRODES	Electrodes positioned according to the specific indication.
INTENSITY	Adjust the stimulation energy so as to produce appropriate muscle responses both in the tetanic contraction phase and in the phase to increase blood flow.
+TENS OPTION	No.

VENOUS INSUFFICIENCY 1 (21 MIN)		
	CONTRACTION	ACTIVE REST
FREQUENCY	50 Hz	8 Hz
DURATION OF RAMP-UP	1.5 s	1 s
DURATION OF PHASE	4 S	21 S
DURATION OF RAMP-DOWN	1.5 s	1 s

13. AVAILABLE THERAPY PROGRAMS

CATEGORY	VASCULAR
PROGRAM	VENOUS INSUFFICIENCY 2
WHEN?	In the event of venous insufficiency without oedema.
WHY?	To encourage drainage of the deep veins and of the oedema.
HOW?	Encourage venous blood return using a sequenced stimulation starting in the leg muscles and continuing to the thigh muscles, supporting the distal tetanic contraction to prevent regurgitation.
PULSE WIDTH	To make it as comfortable as possible for the patient, use pulse widths equivalent to the chronaxies of the motor nerves of the muscles being stimulated. The mi-SCAN function can be used to determine the pulse widths suitable for the patient's muscles.
ELECTRODES	Electrodes positioned according to the specific indication.
INTENSITY	Adjust the stimulation energy in order to produce pronounced but comfortable muscle contractions. The stimulation energies must be greater on channels 1 and 2 than on channels 3 and 4.
+TENS OPTION	No.
NOTE	Take care to properly observe the correct order for switching on the modules, the order of switching on that corresponds to the numbering of the channels. This program needs imperatively 4 stimulation channels. Not applicable with Wireless Professional 2CH.

VENOUS INSUFFICIENCY 2 (21 MIN)			
	1ST CONTRACTION (CH 1+2)	2ND CONTRACTION (CH 1+2+3+4)	REST
FREQUENCY	50 Hz	50 Hz	0 Hz
DURATION OF RAMP-UP	1.5 s	1.5 s	0 s
DURATION OF PHASE	3 s	3 s	19 s
DURATION OF RAMP-DOWN	0 s	1.5 s	0 s

13. AVAILABLE THERAPY PROGRAMS

CATEGORY	VASCULAR
PROGRAM	ARTERIAL INSUFFICIENCY 1
WHEN?	Arterial insufficiency in the lower limbs is conventionally divided into four clinical stages. These four stages (I, II, III, IV) depend on the approximate severity of the loss of blood flow and the tissue-related consequences. The arterial insufficiency 1 programme is to be used to treat Stage II. In Stage II, arterial occlusion is responsible for pain that occurs on exertion and is relieved by resting: this is known as intermittent claudication.
WHY?	To improve the absorption of oxygen by the muscles, increase tolerance on exertion and walking distance.
HOW?	To avoid further reducing the supply of oxygen to the muscle fibres, the contractions remain infra-tetanic (9 Hz) and are separated by long periods of active rest (3 Hz) in order to avoid muscular fatigue.
PULSE WIDTH	To make it as comfortable as possible for the patient, use pulse widths equivalent to the chronaxies of the motor nerves of the muscles being stimulated. The mi-SCAN function can be used to determine the pulse widths suitable for the patient's muscles.
ELECTRODES	Electrodes positioned according to the specific indication.
INTENSITY	Stimulation energies must be increased as high as possible whilst still remaining comfortable for the patient.
+TENS OPTION	No.

ARTERIAL INSUFFICIENCY 1 (14 MIN)		
	CONTRACTION	ACTIVE REST
FREQUENCY	9 Hz	3 Hz
DURATION OF RAMP-UP	1 s	1 s
DURATION OF PHASE	15 s	15 s
DURATION OF RAMP-DOWN	1 s	1 s

13. AVAILABLE THERAPY PROGRAMS

CATEGORY	VASCULAR
PROGRAM	ARTERIAL INSUFFICIENCY 2
WHEN?	Arterial insufficiency in the lower limbs is conventionally divided into four clinical stages. These four stages (I, II, III, IV) depend on the approximate severity of the loss of blood flow and the tissue- related consequences. The Arterial insufficiency 2 programme is used to treat Stage III. At Stage III the severity of the arterial occlusion causes constant pain which occurs even at rest.
WHY?	To improve oxygen uptake by the muscles, to reduce muscular pain at rest and partially restore muscular tolerance to exertion.
HOW?	To avoid further reducing the supply of oxygen to the muscle fibres, the contractions remain infra-tetanic (7 Hz) and are separated by long periods of active rest (2 Hz) in order to avoid muscular fatigue.
PULSE WIDTH	To make it as comfortable as possible for the patient, use pulse widths equivalent to the chronaxies of the motor nerves of the muscles being stimulated. The mi-SCAN function can be used to determine the pulse widths suitable for the patient's muscles.
ELECTRODES	Electrodes positioned according to the specific indication.
INTENSITY	Stimulation energies must be increased as high as possible whilst still remaining comfortable for the patient.
+TENS OPTION	No.

ARTERIAL INSUFFICIENCY 2 (14 MIN)		
	CONTRACTION	ACTIVE REST
FREQUENCY	7 Hz	2 Hz
DURATION OF RAMP-UP	1 s	1 s
DURATION OF PHASE	15 s	15 s
DURATION OF RAMP-DOWN	1 s	1 s

13. AVAILABLE THERAPY PROGRAMS

CATEGORY	VASCULAR
PROGRAM	CRAMP PREVENTION
WHEN?	For people suffering from cramps which may appear spontaneously at rest during the night or following prolonged muscular effort. These cramps can be partially due to an imbalance in the flow of blood through the muscles.
WHY?	To improve the circulatory system to prevent the occurrence of cramps.
HOW?	This programme consists of two different phases: an 8 Hz sequence to improve blood flow and develop blood capillaries. A 3 Hz sequence to relax muscular tonus and increase the well-being of the patient.
PULSE WIDTH	To make it as comfortable as possible for the patient, use pulse widths equivalent to the chronaxies of the motor nerves of the muscles being stimulated. The mi-SCAN function can be used to determine the pulse widths suitable for the patient's muscles.
ELECTRODES	Electrodes positioned depending on the muscle to be stimulated, in accordance with the instructions.
INTENSITY	An essential factor in the effectiveness of electrotherapy is the ability to cause visible muscle twitches. The mi-RANGE function can be used to determine the minimum level of energy required to produce an appropriate muscle response.
+TENS OPTION	No.

CRAMP PREVENTION (*40 MIN)		
	1ST SEQUENCE	2ND SEQUENCE
FREQUENCY	8 Hz	3 Hz
DURATION OF RAMP-UP	1.5 s	1.5 s
DURATION OF PHASE	8 min	2 min
DURATION OF RAMP-DOWN	1.5 s	1.5 s

* 1st and 2nd sequence loop 4 times

13. AVAILABLE THERAPY PROGRAMS

CATEGORY	VASCULAR
PROGRAM	CAPILLARISATION
WHEN?	<p>The 8 Hz frequency produces the greatest increase in blood flow in young patients who are in a good state of physical health. Use of the Capillarisation programme must therefore be restricted to sport rehabilitation and will be proposed in situations where a hyperaemia is desired e.g. to accelerate the scarring process. The Capillarisation programme can also be used for non-injured athletes as part of their physical preparation to achieve a variety of ends:</p> <ul style="list-style-type: none"> • To supplement endurance training • To optimise the overcompensation phase prior to an endurance or resistance competition. • Supplementary use of the Hypertrophy programme
WHY?	To induce the greatest circulatory activation in patients who are athletes. To increase the capillary network and make the muscle fibres more resistant to fatigue.
HOW?	When using low stimulation frequencies of 8 Hz, the increase in blood flow is greatest in young people who are in good physical condition. However a frequency of 8 Hz may cause early muscle fatigue and a depletion in the muscular response in patients with underperforming muscles.
PULSE WIDTH	To make it as comfortable as possible for the patient, use pulse widths equivalent to the chronaxies of the motor nerves of the muscles being stimulated. The mi-SCAN function can be used to determine the pulse widths suitable for the patient's muscles.
ELECTRODES	Electrodes positioned depending on the muscle to be stimulated, in accordance with the instructions.
INTENSITY	An essential factor in the effectiveness of electrotherapy is the ability to cause visible muscle twitches. The mi-RANGE function can be used to determine the minimum level of energy required to produce an appropriate muscle response.
+TENS OPTION	No.

13. AVAILABLE THERAPY PROGRAMS

CAPILLARISATION	
	CONTINUOUS STIMULATION
FREQUENCY	8 Hz
DURATION OF RAMP-UP	1.5 s
DURATION OF PHASE	25 min
DURATION OF RAMP-DOWN	1.5 s

13. AVAILABLE THERAPY PROGRAMS

13.1.4 CONDITIONING I

CATEGORY	CONDITIONING I
PROGRAM	RESISTANCE
WHEN?	For athletes wishing to increase their ability to sustain intense and prolonged exertion, or to develop their ability to maintain or repeat a muscular activity carried out at a high percentage of the maximum strength.
WHY?	Increased anaerobic (lactic) capacity in the muscles. Increased strength endurance.
PULSE WIDTH	To make it as comfortable as possible for the patient, use pulse widths equivalent to the chronaxies of the motor nerves of the muscles being stimulated. The mi-SCAN function can be used to determine the pulse widths suitable for the patient's muscles.
ELECTRODES	Electrodes positioned depending on the muscle to be stimulated, in accordance with the instructions.
INTENSITY	The maximum tolerable stimulation energy, which is one of the key factors determining the effectiveness of the treatment. The higher the stimulation energy, the higher the number of muscle fibres (motor units) being used.
+TENS OPTION	No.

RESISTANCE, LEVEL 1 (27 MIN)				
	WARM UP	CONTRACTION	ACTIVE REST	FINAL RECOVERY PHASE
FREQUENCY	5 Hz	50 Hz	5 Hz	3 Hz
DURATION OF RAMP-UP	1.5 s	1.5 s	0.5 s	1.5 s
DURATION OF PHASE	5 min	7 s	7 s	10 min
DURATION OF RAMP-DOWN	2 s	0.75 s	0.5 s	3 s

13. AVAILABLE THERAPY PROGRAMS

RESISTANCE, LEVEL 2 (28 MIN)				
	WARM UP	CONTRACTION	ACTIVE REST	FINAL RECOVERY PHASE
FREQUENCY	5 Hz	55 Hz	6 Hz	3 Hz
DURATION OF RAMP-UP	1.5 s	1.5 s	0.5 s	1.5 s
DURATION OF PHASE	5 min	8 s	7 s	10 min
DURATION OF RAMP-DOWN	2 s	0.75 s	0.5 s	3 s

RESISTANCE, LEVEL 3 (28 MIN)				
	WARM UP	CONTRACTION	ACTIVE REST	FINAL RECOVERY PHASE
FREQUENCY	5 Hz	60 Hz	7 Hz	3 Hz
DURATION OF RAMP-UP	1.5 s	1.5 s	0.5 s	1.5 s
DURATION OF PHASE	5 min	8 s	6 s	10 min
DURATION OF RAMP-DOWN	2 s	0.75 s	0.5 s	3 s

13. AVAILABLE THERAPY PROGRAMS

CATEGORY	CONDITIONING I
PROGRAM	STRENGTH
WHEN?	For athletes practising a discipline which requires strength and speed.
WHY?	An increase in maximum strength and muscle contraction speed.
PULSE WIDTH	To make it as comfortable as possible for the patient, use pulse widths equivalent to the chronaxies of the motor nerves of the muscles being stimulated. The mi-SCAN function can be used to determine the pulse widths suitable for the patient's muscles.
ELECTRODES	Electrodes positioned depending on the muscle to be stimulated, in accordance with the instructions.
INTENSITY	The maximum tolerable stimulation energy, which is one of the key factors determining the effectiveness of the treatment. The higher the stimulation energy, the higher the number of muscle fibres (motor units) being used.
+TENS OPTION	No.

STRENGTH, LEVEL 1 (33 MIN)				
	WARM UP	CONTRACTION	ACTIVE REST	FINAL RECOVERY PHASE
FREQUENCY	5 Hz	75 Hz	4 Hz	3 Hz
DURATION OF RAMP-UP	1.5 s	1.5 s	0.5 s	1.5 s
DURATION OF PHASE	5 min	4 s	19 s	10 min
DURATION OF RAMP-DOWN	2 s	0.75 s	0.5 s	3 s

13. AVAILABLE THERAPY PROGRAMS

STRENGTH, LEVEL 2 (35 MIN)				
	WARM UP	CONTRACTION	ACTIVE REST	FINAL RECOVERY PHASE
FREQUENCY	5 Hz	83 Hz	4 Hz	3 Hz
DURATION OF RAMP-UP	1.5 s	1.5 s	0.5 s	1.5 s
DURATION OF PHASE	5 min	4 s	23 s	10 min
DURATION OF RAMP-DOWN	2 s	0.75 s	0.5 s	3 s

STRENGTH, LEVEL 3 (38 MIN)				
	WARM UP	CONTRACTION	ACTIVE REST	FINAL RECOVERY PHASE
FREQUENCY	5 Hz	90 Hz	4 Hz	3 Hz
DURATION OF RAMP-UP	1.5 s	1.5 s	0.5 s	1.5 s
DURATION OF PHASE	5 min	4 s	27 s	10 min
DURATION OF RAMP-DOWN	2 s	0.75 s	0.5 s	3 s

13. AVAILABLE THERAPY PROGRAMS

CATEGORY	CONDITIONING I
PROGRAM	ACTIVE RECOVERY
WHEN?	To facilitate and accelerate muscle recuperation after intense exertion. Use this programme during the three hours which follow a period of intense training or a competition.
WHY?	Strong increase in blood flow, accelerated elimination of waste products from muscle contraction and a relaxing endorphinic effect.
PULSE WIDTH	To make it as comfortable as possible for the patient, use pulse widths equivalent to the chronaxies of the motor nerves of the muscles being stimulated. The mi-SCAN function can be used to determine the pulse widths suitable for the patient's muscles.
ELECTRODES	Precision in positioning the electrodes is less significant than for programmes aiming to develop muscle quality. The electrodes can be placed in an alternative way, reducing the number of electrodes needed and stimulating more muscles during a session.
INTENSITY	An essential factor in the effectiveness of electrotherapy is the ability to cause visible muscle twitches. The mi-RANGE function can be used to determine the minimum level of energy required to produce an appropriate muscle response.
+TENS OPTION	No.

ACTIVE RECOVERY (24 MIN)				
	1ST SEQUENCE	2ND SEQUENCE	3RD SEQUENCE	4TH SEQUENCE
FREQUENCY	9 Hz	8 Hz	7 Hz	6 Hz
TIME	2 min	2 min	2 min	3 min
	5TH SEQUENCE	6TH SEQUENCE	7TH SEQUENCE	8TH SEQUENCE
FREQUENCY	5 Hz	4 Hz	3 Hz	2 Hz
TIME	3 min	3 min	3 min	3 min

13. AVAILABLE THERAPY PROGRAMS

13.2 Full Version Programs and their usage (Indication Specific Programs)

Note

- The Full Version offers additional programs to the Standard Version.
- Additional programs to already at Standard version existing program categories are automatically included within the corresponding program category.

REHABILITATION II	146
Hip prosthesis	146
Patellofemoral syndrome	148
ACL	150
Rotator cuff	152
Lumbar stabilization	154
Cardiac rehabilitation	155
Atrophy (modulated frequency)	156
Reinforcement (modulated frequency)	158

AGONIST / ANTAGONIST	160
Atrophy	161
Reinforcement	162

PROG. FOR HAEMOPHILIACS	163
Atrophy	164
Reinforcement	165

NEUROLOGICAL	166
Hemiplegic foot	166
Spasticity	168
Hemiplegic shoulder	170
Slow start neuro rehabilitation	172

PERSONALIZED PROGRAMS	
If programs had been customized and synchronized with the remote control by using the SOFTWARE, they will be shown in this program category.	

13. AVAILABLE THERAPY PROGRAMS

PAIN RELIEF II	174
TENS (Gate control) 80Hz	174
Knee pain	175
Trapezius muscle pain	176
Shoulder pain	177
Fracture pain	178
Cervical pain	179
Thoracic back pain	180
Low back pain	181
Lumbosciatica	183
Lumbago	184
Epicondylitis	187
Torticollis	188
Arthralgia	189

CONDITIONING II	190
Potentialiation	190
Endurance	191
Explosive strength	193
Plyometry	195
Hypertrophy	196
Muscle building	198
Low back reinforcement	200
Core stabilization	202
Recovery plus	204
Toning massage	205
Relaxing massage	206
Anti-stress massage	207

13. AVAILABLE THERAPY PROGRAMS

13.2.1 REHABILITATION II

CATEGORY	REHABILITATION II
PROGRAM	HIP PROSTHESIS
WHEN?	Except where there are complications, as soon as possible following the surgical implantation of a total hip replacement.
WHY?	To restore the muscular qualities of the gluteus medius and gluteus maximus muscles, to recover stability when standing on one foot and to prevent limping.
HOW?	The three levels of the programme correspond to the Disuse atrophy (level 1 and 2) and Reinforcement (level 1) programmes for which the low frequencies have been removed so as not to cause vibration in the prosthesis.
PULSE WIDTH	To make it as comfortable as possible for the patient, use pulse widths equivalent to the chronaxies of the motor nerves of the gluteal muscles. The mi-SCAN function can be used to determine the pulse widths suitable for the patient's muscles.
ELECTRODES	Electrodes positioned on the gluteal muscles must correspond to the specific indication.
INTENSITY	The maximum tolerable stimulation energy, which is one of the key factors determining the effectiveness of the treatment. The higher the stimulation energy, the higher the number of muscle fibres (motor units) being used. Progressively increase the level of energy during the course of a treatment session.
+TENS OPTION	<p>Yes.</p> <ul style="list-style-type: none"> - A minimum of 1 channel with muscular work imposed by the Disuse atrophy programme. - A maximum of 3 channels with the TENS programme. <ul style="list-style-type: none"> • Electrodes positioned on the painful area. • Sufficient stimulation energy to produce a clear tingling sensation. <p>Once the +TENS combination has been activated, the message "TENS" appears on the screen with respect to the channel or channels where the treatment is active. The mi functions – apart from the mi-SCAN – are also no longer accessible.</p> <p>Take care to properly observe the correct order for switching on the modules, the order of switching on that corresponds to the numbering of the channels.</p>

13. AVAILABLE THERAPY PROGRAMS

HIP PROSTHESIS, LEVEL 1 (30 MIN)				
	WARM UP	CONTRACTION	REST	FINAL RECOVERY PHASE
FREQUENCY	-	35 Hz	-	-
DURATION OF RAMP-UP	-	1.5 s	-	-
DURATION OF PHASE	-	6 s	6 s	-
DURATION OF RAMP-DOWN	-	0.75 s	-	-

HIP PROSTHESIS, LEVEL 2 (30 MIN)				
	WARM UP	CONTRACTION	REST	FINAL RECOVERY PHASE
FREQUENCY	-	45 Hz	-	-
DURATION OF RAMP-UP	-	1.5 s	-	-
DURATION OF PHASE	-	6 s	6 s	-
DURATION OF RAMP-DOWN	-	0.75 s	-	-

HIP PROSTHESIS, LEVEL 3 (15 MIN)				
	WARM UP	CONTRACTION	REST	FINAL RECOVERY PHASE
FREQUENCY	-	75 Hz	-	-
DURATION OF RAMP-UP	-	1.5 s	-	-
DURATION OF PHASE	-	4 s	11 s	-
DURATION OF RAMP-DOWN	-	0.75 s	-	-

13. AVAILABLE THERAPY PROGRAMS

CATEGORY	REHABILITATION II
PROGRAM	PATELLOFEMORAL SYNDROME
WHEN?	In conjunction with the rehabilitation of centred (post-traumatic chondropathy) or decentred (external subluxation of the patella) patellofemoral syndromes.
WHY?	To restore the trophicity of muscle fibres altered during the muscle disuse atrophy process and to develop the active stability of the knee.
HOW?	Depending upon the diagnosis, stimulation will either involve all of the heads of the quadriceps muscle or it will be limited solely to the vastus medialis. The three levels of the programme correspond to the Disuse atrophy (level 1 and 2) programmes and the Reinforcement (level 1) programmes respectively, for which the low frequencies have been removed so as not to cause micro-trauma in the patella.
PULSE WIDTH	To make it as comfortable as possible for the patient, use pulse widths equivalent to the chronaxies of the motor nerves of the gluteal muscles. The mi-SCAN function can be used to determine the pulse widths suitable for the patient's muscles.
ELECTRODES	Electrodes positioned on the quadriceps or only on the vastus medialis in accordance with the specific indication.
INTENSITY	The maximum tolerable stimulation energy, which is one of the key factors determining the effectiveness of the treatment. The higher the stimulation energy, the higher the number of muscle fibres (motor units) being used. Progressively increase the level of energy during the course of a treatment session.
+TENS OPTION	<p>Yes.</p> <ul style="list-style-type: none"> - A minimum of 1 channel with muscular work imposed by the Disuse atrophy programme. - A maximum of 3 channels with the TENS programme. <ul style="list-style-type: none"> • Electrodes positioned on the painful area. • Sufficient stimulation energy to produce a clear tingling sensation. <p>Once the +TENS combination has been activated, the message "TENS" appears on the screen with respect to the channel or channels where the treatment is active. The mi functions – apart from the mi-SCAN – are also no longer accessible.</p> <p>Take care to properly observe the correct order for switching on the modules, the order of switching on that corresponds to the numbering of the channels.</p>

13. AVAILABLE THERAPY PROGRAMS

PATELLOFEMORAL SYNDROME LEVEL 1 = DISUSE ATROPHY, LEVEL 1 (30 MIN)				
	WARM UP	CONTRACTION	REST	FINAL RECOVERY PHASE
FREQUENCY	-	35 Hz	-	-
DURATION OF RAMP-UP	-	1.5 s	-	-
DURATION OF PHASE	-	6 s	6 s	-
DURATION OF RAMP-DOWN	-	0.75 s	-	-

PATELLOFEMORAL SYNDROME LEVEL 2 = DISUSE ATROPHY, LEVEL 2 (30 MIN)				
	WARM UP	CONTRACTION	REST	FINAL RECOVERY PHASE
FREQUENCY	-	45 Hz	-	-
DURATION OF RAMP-UP	-	1.5 s	-	-
DURATION OF PHASE	-	6 s	6 s	-
DURATION OF RAMP-DOWN	-	0.75 s	-	-

PATELLOFEMORAL SYNDROME LEVEL 3 = DISUSE ATROPHY, LEVEL 1 (15 MIN)				
	WARM UP	CONTRACTION	REST	FINAL RECOVERY PHASE
FREQUENCY	-	75 Hz	-	-
DURATION OF RAMP-UP	-	1.5 s	-	-
DURATION OF PHASE	-	4 s	11 s	-
DURATION OF RAMP-DOWN	-	0.75 s	-	-

13. AVAILABLE THERAPY PROGRAMS

CATEGORY	REHABILITATION II
PROGRAM	ACL
WHEN?	As a supplement to rehabilitation of a ligamentoplasty of the anterior cruciate ligament of the knee. The programme can be used early as it does not put any stress on the tendon graft.
WHY?	To restore the muscular qualities of the quadriceps and the hamstrings and recover a stable knee to allow the safe resumption of active sport.
HOW?	The ACL programme is specifically designed for the rehabilitation of ligamentoplasties. It allows intensive use of the quadriceps while protecting the tendon graft during the first few post-operative weeks due to co-activation of the hamstring muscles. Stimulation starts with the hamstrings (channels 1 and 2). While they are contracted, stimulation continues on the quadriceps (channels 3 and 4), thus preventing any risk of anterior draw movement.
PULSE WIDTH	To make it as comfortable as possible for the patient, use pulse widths equivalent to the chronaxies of the motor nerves of the quadriceps and hamstring muscles. The mi-SCAN function can be used to determine the pulse widths suitable for the patient's muscles.
ELECTRODES	Electrodes positioned on the gluteal muscles must correspond to the specific indication.
INTENSITY	The maximum tolerable stimulation energy on the 4 channels, which is one of the key factors determining the effectiveness of the treatment. The higher the stimulation energy, the higher the number of muscle fibres (motor units) being used. Progressively increase the level of energy during the course of a treatment session.
+TENS OPTION	No.
NOTE	Take care to properly observe the correct order for switching on the modules, the order of switching on that corresponds to the numbering of the channels. This programme only works with 4 modules switched on.

13. AVAILABLE THERAPY PROGRAMS

ACL (30 MIN)			
	1ST CONTRACTION (CH 1+2) HAMSTRINGS	2ND CONTRACTION (CH 1+2+3+4) HAMSTRINGS + QUADRICEPS	ACTIVE REST
FREQUENCY	40 Hz	40 Hz	4 Hz
DURATION OF RAMP-UP	1.5 s	3 s	0.5 s
DURATION OF PHASE	3 s	6 s	8 s
DURATION OF RAMP-DOWN	0 s	0.75 s	0.5 s

13. AVAILABLE THERAPY PROGRAMS

CATEGORY	REHABILITATION II
PROGRAM	ROTATOR CUFF
WHEN?	In addition to the rehabilitation of rotator cuff tendinopathies, after sedation of acute pain and manual correction of joint misalignment.
WHY?	To develop the active stability of the shoulder by restoring the functional attributes of the muscles supporting the glenohumeral joint.
HOW?	Selective stimulation of the infraspinatus and supraspinatus muscles using parameters adapted to their postural function (type I fibres). Combination with a TENS programme for a combined analgesic effect.
PULSE WIDTH	To make it as comfortable as possible for the patient, use pulse widths equivalent to the chronaxies of the motor nerves of the infraspinatus and supraspinatus muscles. The mi-SCAN function can be used to determine the pulse widths suitable for the patient's muscles.
ELECTRODES	Electrodes positioned according to the specific indication.
INTENSITY	The maximum tolerable stimulation energy on the 4 channels, which is one of the key factors determining the effectiveness of the treatment. The higher the stimulation energy, the higher the number of muscle fibres (motor units) being used. Progressively increase the level of energy during the course of a treatment session.
+TENS OPTION	<p>Yes.</p> <ul style="list-style-type: none"> - A minimum of 1 channel with muscular work imposed by the Disuse atrophy programme. - A maximum of 3 channels with the TENS programme. <ul style="list-style-type: none"> • Electrodes positioned on the painful area. • Sufficient stimulation energy to produce a clear tingling sensation. <p>Once the +TENS combination has been activated, the message "TENS" appears on the screen with respect to the channel or channels where the treatment is active. The mi functions – apart from the mi-SCAN – are also no longer accessible.</p> <p>Take care to properly observe the correct order for switching on the modules, the order of switching on that corresponds to the numbering of the channels.</p>

13. AVAILABLE THERAPY PROGRAMS

ROTATOR CUFF, LEVEL 1 (25 MIN)				
	WARM UP	CONTRACTION	ACTIVE REST	FINAL RECOVERY PHASE
FREQUENCY	6 Hz	35 Hz	4 Hz	3 Hz
DURATION OF RAMP-UP	1.5 s	1.5 s	0.5 s	1.5 s
DURATION OF PHASE	2 min	6 s	7 s	3 min
DURATION OF RAMP-DOWN	2 s	0.75 s	0.5 s	3 s

ROTATOR CUFF, LEVEL 2 (25 MIN)				
	WARM UP	CONTRACTION	ACTIVE REST	FINAL RECOVERY PHASE
FREQUENCY	6 Hz	45 Hz	4 Hz	3 Hz
DURATION OF RAMP-UP	1.5 s	1.5 s	0.5 s	1.5 s
DURATION OF PHASE	2 min	6 s	5 s	3 min
DURATION OF RAMP-DOWN	2 s	0.75 s	0.5 s	3 s

ROTATOR CUFF, LEVEL 3 (20 MIN)				
	WARM UP	CONTRACTION	ACTIVE REST	FINAL RECOVERY PHASE
FREQUENCY	6 Hz	75 Hz	4 Hz	3 Hz
DURATION OF RAMP-UP	1.5 s	1.5 s	0.5 s	1.5 s
DURATION OF PHASE	2 min	4 s	10 s	3 min
DURATION OF RAMP-DOWN	2 s	0.75 s	0.5 s	3 s

13. AVAILABLE THERAPY PROGRAMS

CATEGORY	REHABILITATION II
PROGRAM	BACK/TRUNK STABILISATION
WHEN?	After an episode of low back pain, once the pain has been relieved. Muscular work by electrostimulation has the advantage of being carried out isometrically with very little stress on the vertebral structures and discs.
WHY?	To develop the support qualities of the abdominal and lumbar muscles and to restore awareness of postural control.
HOW?	By simultaneously stimulating the abdominal and lumbar muscle groups, using parameters adapted to restoring the qualities of type I muscle fibres used in postural control.
PULSE WIDTH	To make it as comfortable as possible for the patient, use pulse widths equivalent to the chronaxies of the motor nerves of the abdominal and lumbar muscles. The mi-SCAN function can be used to determine the pulse widths suitable for the patient's muscles.
ELECTRODES	Electrodes positioned jointly on the abdominal and lumbar muscles in accordance with the specific indication.
INTENSITY	The maximum tolerable stimulation energy on the 4 channels, which is one of the key factors determining the effectiveness of the treatment. The higher the stimulation energy, the higher the number of muscle fibres (motor units) being used. Progressively increase the level of energy during the course of a treatment session.
+TENS OPTION	No.

BACK/TRUNK STABILISATION (30 MIN)				
	WARM UP	CONTRACTION	ACTIVE REST	FINAL RECOVERY PHASE
FREQUENCY	6 Hz	40 Hz	4 Hz	3 Hz
DURATION OF RAMP-UP	1.5 s	2 s	0.5 s	1.5 s
DURATION OF PHASE	2 min	6 s	12 s	3 min
DURATION OF RAMP-DOWN	2 s	1 s	0.5 s	3 s

13. AVAILABLE THERAPY PROGRAMS

CATEGORY	REHABILITATION II
PROGRAM	CARDIAC REHABILITATION
WHEN?	In addition to the aerobic exercises suggested during cardiac rehabilitation.
WHY?	Heart failure limits the capacity for exertion linked, in part, to changes in the peripheral muscles. Electrostimulation allows muscle qualities to be improved, in particular aerobic capacity, which contributes to improving tolerance of exertion and the quality of life in patients suffering from severe cardiac failure.
HOW?	The work regime imposed by the cardiac rehabilitation programme uses the oxidative metabolism through contractions which are of low power but very long and repeated over a long period (1 hour).
PULSE WIDTH	To make it as comfortable as possible for the patient, use pulse widths equivalent to the chronaxies of the motor nerves of the abdominal and lumbar muscles. The mi-SCAN function can be used to determine the pulse widths suitable for the patient's muscles.
ELECTRODES	The quadriceps muscles are a priority because of their volume and their functional importance. Electrodes must be positioned according to the specific indication.
INTENSITY	The maximum tolerable stimulation energy on the 4 channels, which is one of the key factors determining the effectiveness of the treatment. The higher the stimulation energy, the higher the number of muscle fibres (motor units) being used. Progressively increase the level of energy during the course of a treatment session.
+TENS OPTION	No.

CARDIO TRAINING (60 MIN)				
	WARM UP	CONTRACTION	REST	FINAL RECOVERY PHASE
FREQUENCY	-	10 Hz	-	-
DURATION OF RAMP-UP	-	2 s	-	-
DURATION OF PHASE	-	20 s	20 s	-
DURATION OF RAMP-DOWN	-	1 s	-	-

13. AVAILABLE THERAPY PROGRAMS

CATEGORY	REHABILITATION II
PROGRAM	ATROPHY (MODULATED FREQUENCY)
WHEN?	Use on weakened muscles following immobilisation or restricted activity.
WHY?	The programme imposes a work regime adapted to the physiology of the type I fibres where the qualities have been altered during muscle disuse atrophy.
HOW?	Progressive incrementation of the frequency (25-40Hz) at the beginning of each contraction may improve the comfort of the stimulation in hypersensitive patients.
PULSE WIDTH	To make it as comfortable as possible for the patient, use pulse widths equivalent to the chronaxies of the motor nerves of the abdominal and lumbar muscles. The mi-SCAN function can be used to determine the pulse widths suitable for the patient's muscles.
ELECTRODES	Electrodes positioned depending on the muscle to be stimulated, in accordance with the instructions.
INTENSITY	The maximum tolerable stimulation energy on the 4 channels, which is one of the key factors determining the effectiveness of the treatment. The higher the stimulation energy, the higher the number of muscle fibres (motor units) being used. Progressively increase the level of energy during the course of a treatment session.
+TENS OPTION	<p>Yes.</p> <ul style="list-style-type: none"> - A minimum of 1 channel with muscular work imposed by the Disuse atrophy programme. - A maximum of 3 channels with the TENS programme. <ul style="list-style-type: none"> • Electrodes positioned on the painful area. • Sufficient stimulation energy to produce a clear tingling sensation. <p>Once the +TENS combination has been activated, the message "TENS" appears on the screen with respect to the channel or channels where the treatment is active. The mi functions – apart from the mi-SCAN – are also no longer accessible.</p> <p>Take care to properly observe the correct order for switching on the modules, the order of switching on that corresponds to the numbering of the channels.</p>

13. AVAILABLE THERAPY PROGRAMS

ATROPHY, MODULATED FREQUENCY (30 MIN)				
	WARM UP	CONTRACTION	ACTIVE REST	FINAL RECOVERY PHASE
FREQUENCY	6 Hz	25-40 Hz	4 Hz	3 Hz
DURATION OF RAMP-UP	1.5 s	2 s	0.5 s	1.5 s
DURATION OF PHASE	2 min	4 s	8 s	3 min
DURATION OF RAMP-DOWN	2 s	1 s	0.5 s	3 s

13. AVAILABLE THERAPY PROGRAMS

CATEGORY	REHABILITATION II
PROGRAM	REINFORCEMENT (MODULATED FREQUENCY)
WHEN?	For use either on previously atrophied muscles which have regained their volume as a result of electrostimulation with disuse atrophy treatment programmes, or as a first-line treatment on non-atrophied muscles which have lost their strength and speed of contraction.
WHY?	The programme imposes a work regime adapted to the physiology of the type II fibres to restore contraction strength in the case of muscular insufficiency without marked disuse atrophy or following recovery of muscle volume.
HOW?	Progressive incrementation of the frequency (35-60 Hz) at the beginning of each contraction may improve the comfort of the stimulation in hypersensitive patients.
PULSE WIDTH	To make it as comfortable as possible for the patient, use pulse widths equivalent to the chronaxies of the motor nerves of the abdominal and lumbar muscles. The mi-SCAN can be used to determine the pulse widths suitable for the patient's muscles.
ELECTRODES	Electrodes positioned depending on the muscle to be stimulated, in accordance with the instructions.
INTENSITY	The maximum tolerable stimulation energy on the 4 channels, which is one of the key factors determining the effectiveness of the treatment. The higher the stimulation energy, the higher the number of muscle fibres (motor units) being used. Progressively increase the level of energy during the course of a treatment session.
+TENS OPTION	<p>Yes.</p> <ul style="list-style-type: none"> - A minimum of 1 channel with muscular work imposed by the Disuse atrophy programme. - A maximum of 3 channels with the TENS programme. <ul style="list-style-type: none"> • Electrodes positioned on the painful area. • Sufficient stimulation energy to produce a clear tingling sensation. <p>Once the +TENS combination has been activated, the message "TENS" appears on the screen with respect to the channel or channels where the treatment is active. The mi functions – apart from the mi-SCAN – are also no longer accessible.</p> <p>Take care to properly observe the correct order for switching on the modules, the order of switching on that corresponds to the numbering of the channels.</p>

13. AVAILABLE THERAPY PROGRAMS

FORCE, MOD. FREQUENCY (30 MIN)				
	WARM UP	CONTRACTION	ACTIVE REST	FINAL RECOVERY PHASE
FREQUENCY	6 Hz	35-60 Hz	4 Hz	3 Hz
DURATION OF RAMP-UP	1.5 s	3 s	0.5 s	1.5 s
DURATION OF PHASE	2 min	8 s	15 s	3 min
DURATION OF RAMP-DOWN	2 s	1 s	0.5 s	3 s

13. AVAILABLE THERAPY PROGRAMS

13.2.2 AGONIST / ANTAGONIST

CATEGORY	AGONIST / ANTAGONIST
PROGRAM	ATROPHY / REINFORCEMENT
WHEN?	The alternate stimulation of the two antagonistic muscle groups has the advantage of allowing the active mobilisation of a joint while inducing muscle work which is beneficial to functional recuperation.
WHY?	To combine muscle work aimed at successively restoring the two types of muscle fibres (disuse atrophy, then reinforcement) to give mobility across the full range of movement of the joint. This type of use is particularly interesting for combating adhesion.
HOW?	There are four different programmes: - Atrophy 1/1 and Reinforcement 1/1. These programmes produce identical length contractions for the agonist and the antagonist. - Atrophy 2/1 and Reinforcement 2/1. These programmes produce contractions for the agonist which are twice as long as for the antagonist.
PULSE WIDTH	To make it as comfortable as possible for the patient, use pulse widths equivalent to the chronaxies of the motor nerves of the abdominal and lumbar muscles. The mi-SCAN function can be used to determine the pulse widths suitable for the patient's muscles.
ELECTRODES	Electrodes positioned depending on the muscle to be stimulated, in accordance with the instructions.
INTENSITY	The stimulation energies must be adjusted successively for each muscle group to obtain joint mobility in the desired range.
+TENS OPTION	No.
NOTE	For 2-channel configuration, channels 1 and 2 alternate. Take care to properly position channel 1 on the agonist and channel 2 on the antagonist. For 4-channel configuration, channels 1+2 alternate with channels 3+4. Take care to properly position channels 1 and 2 on the agonist and channels 3 and 4 on the antagonist.

13. AVAILABLE THERAPY PROGRAMS

ATROPHY 1 (21 MIN)				
	SEQUENCE 1 AGONIST	SEQUENCE 1 ANTAGONIST	SEQUENCE 2 AGONIST	SEQUENCE 2 ANTAGONIST
FREQUENCY	35 Hz	0 Hz	0 Hz	35 Hz
DURATION OF RAMP-UP	1.5 s	0 s	0 s	1.5 s
DURATION OF PHASE	6 s	6 s	6 s	6 s
DURATION OF RAMP-DOWN	0.75 s	0 s	0 s	0.75 s

ATROPHY 2 (21 MIN)				
	SEQUENCE 1 AGONIST	SEQUENCE 1 ANTAGONIST	SEQUENCE 2 AGONIST	SEQUENCE 2 ANTAGONIST
FREQUENCY	35 Hz	0 Hz	0 Hz	35 Hz
DURATION OF RAMP-UP	1.5 s	0 s	0 s	1.5 s
DURATION OF PHASE	8 s	8 s	4 s	8 s
DURATION OF RAMP-DOWN	0.75 s	0 s	0 s	0.75 s

13. AVAILABLE THERAPY PROGRAMS

REINFORCEMENT 1 (16 MIN)				
	SEQUENCE 1 AGONIST	SEQUENCE 1 ANTAGONIST	SEQUENCE 2 AGONIST	SEQUENCE 2 ANTAGONIST
FREQUENCY	70 Hz	4 Hz	4 Hz	70 Hz
DURATION OF RAMP-UP	1.5 s	0.5 s	0.5 s	1.5 s
DURATION OF PHASE	4 s	3 s	3 s	4 s
DURATION OF RAMP-DOWN	0.75 s	0.5 s	0.5 s	0.75 s

REINFORCEMENT 2 (17 MIN)				
	SEQUENCE 1 AGONIST	SEQUENCE 1 ANTAGONIST	SEQUENCE 2 AGONIST	SEQUENCE 2 ANTAGONIST
FREQUENCY	70 Hz	4 Hz	70 Hz	4 Hz
DURATION OF RAMP-UP	1.5 s	0.5 s	1.5 s	0.5 s
DURATION OF PHASE	6 s	4 s	3 s	3 s
DURATION OF RAMP-DOWN	0.75 s	0.5 s	0.75 s	0.5 s

13. AVAILABLE THERAPY PROGRAMS

13.2.3 PROGRAMMES FOR HAEMOPHILIACS

CATEGORY	PROGRAMMES FOR HAEMOPHILIACS
PROGRAM	ATROPHY / REINFORCEMENT
WHEN?	To prevent disuse atrophy or restore muscular qualities in haemophilia patients suffering from arthropathy.
WHY?	Repeated episodes of haemarthrosis (intra-articular bleeding) may lead to actual cases of arthropathy which cripple haemophiliacs especially as they are usually accompanied by a loss of joint stability. Specific programmes for haemophiliacs aim to improve the active joint stability by restoring the qualities specific to each type of muscle fibre.
HOW?	The characteristic of the programmes for haemophiliacs is to induce muscular contractions very gradually to avoid any risk of causing microlesions in the muscle fibres and/or supporting connective tissue and secondary bleeds.
PULSE WIDTH	To make it as comfortable as possible for the patient, use pulse widths equivalent to the chronaxies of the motor nerves of the abdominal and lumbar muscles. The mi-SCAN function can be used to determine the pulse widths suitable for the patient's muscles.
ELECTRODES	Electrodes positioned depending on the muscle to be stimulated, in accordance with the instructions.
INTENSITY	The maximum tolerable stimulation energy, which is one of the key factors determining the effectiveness of the treatment. The higher the stimulation energy, the higher the number of muscle fibres (motor units) being used. Very gradually increase the level of energy during the course of a treatment session.
+TENS OPTION	<p>Yes.</p> <ul style="list-style-type: none"> - A minimum of 1 channel with muscular work imposed by the Disuse atrophy programme. - A maximum of 3 channels with the TENS programme. <ul style="list-style-type: none"> • Electrodes positioned on the painful area. • Sufficient stimulation energy to produce a clear tingling sensation. <p>Once the +TENS combination has been activated, the message "TENS" appears on the screen with respect to the channel or channels where the treatment is active. The mi functions – apart from the mi-SCAN – are also no longer accessible.</p> <p>Take care to properly observe the correct order for switching on the modules, the order of switching on that corresponds to the numbering of the channels.</p>

13. AVAILABLE THERAPY PROGRAMS

HAEMOPHILIA, DISUSE ATROPHY, LEVEL 1 (25 MIN)		
	CONTRACTION	REST
FREQUENCY	40 Hz	0 Hz
DURATION OF RAMP-UP	6 s	0 s
DURATION OF PHASE	3 s	10 s
DURATION OF RAMP-DOWN	1.5 s	0 s

HAEMOPHILIA, DISUSE ATROPHY, LEVEL 2 (32 MIN)		
	CONTRACTION	REST
FREQUENCY	45 Hz	0 Hz
DURATION OF RAMP-UP	6 s	0 s
DURATION OF PHASE	5 s	9 s
DURATION OF RAMP-DOWN	1.5 s	0 s

13. AVAILABLE THERAPY PROGRAMS

HAEMOPHILIA, REINFORCEMENT, LEVEL 1 (15 MIN)		
	CONTRACTION	REST
FREQUENCY	70 Hz	0 Hz
DURATION OF RAMP-UP	6 s	0 s
DURATION OF PHASE	3 s	10 s
DURATION OF RAMP-DOWN	1.5 s	0 s

HAEMOPHILIA, REINFORCEMENT, LEVEL 2 (20 MIN)		
	CONTRACTION	REST
FREQUENCY	80 Hz	0 Hz
DURATION OF RAMP-UP	6 s	0 s
DURATION OF PHASE	3 s	15 s
DURATION OF RAMP-DOWN	1.5 s	0 s

13. AVAILABLE THERAPY PROGRAMS

13.2.4 NEUROLOGICAL

CATEGORY	NEUROLOGICAL
PROGRAM	HEMIPLEGIC FOOT
WHEN?	<p>One of the problems faced by hemiplegics is the greater or lesser degree of difficulty in raising the toe of the foot. Consequently, this produces steppage during the swing phase of the gait.</p> <p>This programme is not recommended if:</p> <ol style="list-style-type: none"> the stimulation of the levator muscles in the foot causes a spasm in the muscles of the lower limb to reflex. the spasticity of the triceps surae is high. In such cases use a preparation programme which inhibits the tone.
WHY?	To prevent foot drop during the swing phase of the gait.
HOW?	By manually triggering an electrically induced tetanic contraction in the levator muscles of the foot that is synchronised with the gait phase where the foot is lifted off the ground.
PULSE WIDTH	To make it as comfortable as possible for the patient, use pulse widths equivalent to the chronaxies of the motor nerves of the abdominal and lumbar muscles. The mi-SCAN function can be used to determine the pulse widths suitable for the patient's muscles.
ELECTRODES	Electrodes positioned depending on the muscle to be stimulated, in accordance with the instructions.
INTENSITY	In this case, use an intensity that is sufficient to provide a degree of contraction that can cause dorsiflexion of the ankle during the swing phase of the gait.
+TENS OPTION	No.

13. AVAILABLE THERAPY PROGRAMS

HEMIPLEGIC FOOT (13 MIN, TRIGGERED)	
	CONTRACTION
FREQUENCY	50 Hz
DURATION OF RAMP-UP	0.5 s
DURATION OF PHASE	1.5 s
DURATION OF RAMP-DOWN	0.25 s

13. AVAILABLE THERAPY PROGRAMS

CATEGORY	NEUROLOGICAL
PROGRAM	SPASTICITY
WHEN?	Spastic hypertonia develops in the different types of lesions of the central nervous system pathways. Since it is no longer under the control of the higher nervous centres, the myotatic reflex becomes hyperactive and hypertension develops predominantly in the anti-gravity muscles. Over time, spasticity may lead to muscle contractures and a decreased range of movement.
WHY?	To reduce spasticity by inhibiting the motor neurons of the spastic muscle through reciprocal inhibition reflex.
HOW?	Stimulating the antagonistic muscle to the spastic muscle by reciprocal inhibitory reflex. This programme has a very gradual rate of tensioning and does not use low frequencies in order to avoid triggering the myotatic reflex (monosynaptic stretch reflex) of the spastic muscle.
PULSE WIDTH	To make it as comfortable as possible for the patient, use pulse widths equivalent to the chronaxies of the motor nerves of the abdominal and lumbar muscles. The mi-SCAN function can be used to determine the pulse widths suitable for the patient's muscles.
ELECTRODES	Electrodes positioned depending on the muscle to be stimulated, in accordance with the instructions.
INTENSITY	Use the necessary energy to produce a contraction that is capable of causing movement across the whole of its range. Care must always be taken to ensure that the stimulation does not spread as far as the spastic muscle.
+TENS OPTION	<p>Yes.</p> <ul style="list-style-type: none"> - A minimum of 1 channel with muscular work imposed by the Disuse atrophy programme. - A maximum of 3 channels with the TENS programme. <ul style="list-style-type: none"> • Electrodes positioned on the painful area. • Sufficient stimulation energy to produce a clear tingling sensation. <p>Once the +TENS combination has been activated, the message "TENS" appears on the screen with respect to the channel or channels where the treatment is active. The mi functions – apart from the mi-SCAN – are also no longer accessible.</p> <p>Take care to properly observe the correct order for switching on the modules, the order of switching on that corresponds to the numbering of the channels.</p>

13. AVAILABLE THERAPY PROGRAMS

SPASTICITY (21 MIN, TRIGGERED)		
	CONTRACTION	REST
FREQUENCY	35 Hz	0 Hz
DURATION OF RAMP-UP	4.5 s	0 s
DURATION OF PHASE	5 s	5 s
DURATION OF RAMP-DOWN	3 s	0 s

13. AVAILABLE THERAPY PROGRAMS

CATEGORY	NEUROLOGICAL
PROGRAM	HEMIPLEGIC SHOULDER
WHEN?	The shortage of suspensory muscles in the humeral head combined with spasticity of the pectoralis major can often be a cause of a lower subluxation of the shoulder in hemiplegic patients. This is always painful and often develops into a complex regional pain syndrome.
WHY?	To reduce shoulder pain and to treat or prevent subluxations of the shoulder.
HOW?	Stimulating the deltoid and the supraspinatus facilitates a reduction of spasticity in the pectoralis major by reciprocal inhibition reflex. This programme has a very gradual rate of tensioning and does not use low frequencies in order to avoid myotatic reflex stretching (monosynaptic stretch reflex) of the spastic muscle.
PULSE WIDTH	To make it as comfortable as possible for the patient, use pulse widths equivalent to the chronaxies of the motor nerves of the abdominal and lumbar muscles. The mi-SCAN function can be used to determine the pulse widths suitable for the patient's muscles.
ELECTRODES	Electrodes positioned according to the specific indication.
INTENSITY	Use the necessary energy to effect strong contractions of the deltoid and the supraspinatus to elevate the shoulder stump whilst ensuring that this electrically induced activation does not spread to the adductor and depressor muscles of the shoulder.
+TENS OPTION	<p>Yes.</p> <ul style="list-style-type: none"> - A minimum of 1 channel with muscular work imposed by the Disuse atrophy programme. - A maximum of 3 channels with the TENS programme. <ul style="list-style-type: none"> • Electrodes positioned on the painful area. • Sufficient stimulation energy to produce a clear tingling sensation. <p>Once the +TENS combination has been activated, the message "TENS" appears on the screen with respect to the channel or channels where the treatment is active. The mi functions – apart from the mi-SCAN – are also no longer accessible.</p> <p>Take care to properly observe the correct order for switching on the modules, the order of switching on that corresponds to the numbering of the channels.</p>

13. AVAILABLE THERAPY PROGRAMS

SHOULDER SUBLUXATION (25 MIN)		
	CONTRACTION	REST
FREQUENCY	40 Hz	0 Hz
DURATION OF RAMP-UP	3 s	0 s
DURATION OF PHASE	8 s	8 s
DURATION OF RAMP-DOWN	1.5 s	0 s

13. AVAILABLE THERAPY PROGRAMS

CATEGORY	NEUROLOGICAL
PROGRAM	SLOW START NEURO REHABILITATION
WHEN?	Electrostimulation is an excellent complement to traditional kinesiotherapy for many central neurological diseases such as hemiplegia. Treatment must be used in conjunction with passive mobilisation but should also preferably be combined with active movement as soon as the patient's recovery permits.
WHY?	To help facilitate motor control and motor relearning.
HOW?	The programme has a very gradual rate of tensioning followed by a long period of rest. Mobilisation must be synchronised with the contraction induced by the stimulation.
PULSE WIDTH	To make it as comfortable as possible for the patient, use pulse widths equivalent to the chronaxies of the motor nerves of the abdominal and lumbar muscles. The mi-SCAN function can be used to determine the pulse widths suitable for the patient's muscles.
ELECTRODES	Electrodes positioned depending on the muscle to be stimulated, in accordance with the instructions.
INTENSITY	The maximum tolerable stimulation energy, which is one of the key factors determining the effectiveness of the treatment. The higher the stimulation energy, the higher the number of muscle fibres (motor units) being used. Progressively increase the level of energy during the course of a treatment session.
+TENS OPTION	<p>Yes.</p> <ul style="list-style-type: none"> - A minimum of 1 channel with muscular work imposed by the Disuse atrophy programme. - A maximum of 3 channels with the TENS programme. <ul style="list-style-type: none"> • Electrodes positioned on the painful area. • Sufficient stimulation energy to produce a clear tingling sensation. <p>Once the +TENS combination has been activated, the message "TENS" appears on the screen with respect to the channel or channels where the treatment is active. The mi functions – apart from the mi-SCAN – are also no longer accessible.</p> <p>Take care to properly observe the correct order for switching on the modules, the order of switching on that corresponds to the numbering of the channels.</p>

13. AVAILABLE THERAPY PROGRAMS

NEURO REHAB (SLOW START), LEVEL 1 (20 MIN)				
	WARM UP	CONTRACTION	REST	FINAL RECOVERY PHASE
FREQUENCY	6 Hz	35 Hz	-	3 Hz
DURATION OF RAMP-UP	1.5 s	4 s	-	1.5 s
DURATION OF PHASE	2 min	5 s	15 s	3 min
DURATION OF RAMP-DOWN	2 s	2 s	-	3 s

NEURO REHAB (SLOW START), LEVEL 2 (20 MIN)				
	WARM UP	CONTRACTION	REST	FINAL RECOVERY PHASE
FREQUENCY	6 Hz	45 Hz	-	3 Hz
DURATION OF RAMP-UP	1.5 s	4 s	-	1.5 s
DURATION OF PHASE	2 min	5 s	15 s	3 min
DURATION OF RAMP-DOWN	2 s	2 s	-	3 s

13. AVAILABLE THERAPY PROGRAMS

13.2.5 PAIN RELIEF II

CATEGORY	PAIN RELIEF II
PROGRAM	TENS 80Hz
WHEN?	Gate control, which is activated during TENS stimulation, is particularly effective for the relief of localised pain of non-muscular origin. It is particularly effective for relieving neuropathic pain and inflammatory conditions. The sessions may be repeated at will and without restriction, depending upon the intensity of the pain.
WHY?	Without side effects, TENS Gate control effectively relieves pain and improves the patient's level of comfort. The sedation period that results from the stimulation allows the vicious, self-perpetuating cycle of pain to be broken.
HOW?	The principle involves causing high levels of sensitivity impulses in order to limit the input of pain impulses when they return to the posterior horn of the spinal cord. Apart from the 80 Hz frequency, this programme specifically tries to stimulate other sensory fibres (pressure, vibration) in addition to stimulation of the A β fibres (tactile sensitivity).
PULSE WIDTH	The pulse width for the programme is 180 μ s.
ELECTRODES	The electrodes are usually placed in such a way as to cover or surround the painful area.
INTENSITY	The intensity must be increased gradually until the patient feels a tingling sensation that is pronounced without being painful.
+TENS OPTION	No.

TENS			
FREQUENCY	PULSE WIDTH	MODULATION TIME	TREATMENT TIME
80 Hz	180 μ s	-	30 min

13. AVAILABLE THERAPY PROGRAMS

CATEGORY	PAIN RELIEF II
PROGRAM	KNEE PAIN
WHEN?	To relieve knee-joint pain, irrespective of its cause (gonarthrosis, rheumatoid polyarthritis, chondromalacia, etc.)
WHY?	For the relief of pain.
HOW?	Using the Gate control principle. This involves causing high levels of sensitivity impulses in order to limit the input of pain impulses when they return to the posterior horn of the spinal cord.
PULSE WIDTH	The pulse width varies continuously with this programme. This avoids habituation by using a system of stimulation that is perceived as more pleasant by some patients.
ELECTRODES	Depending upon the pain, four large electrodes placed around the patella produce a significant analgesic effect on all knee pain.
INTENSITY	The intensity must be increased gradually until the patient feels a tingling sensation that is pronounced without being painful.
+TENS OPTION	No.

KNEE PAIN			
FREQUENCY	PULSE WIDTH	MODULATION TIME	TREATMENT TIME
80 Hz	75-180 μ s	2 s	30 min

13. AVAILABLE THERAPY PROGRAMS

CATEGORY	PAIN RELIEF II
PROGRAM	TRAPEZIUS MUSCLE PAIN
WHEN?	As with all muscular pains, pain in the trapezius muscles can best be relieved by endorphin stimulation. However, TENS stimulation may be preferable for the first sessions if there is acute pain in an area of inflammation.
WHY?	For the relief of pain.
HOW?	Using the Gate control principle. This involves causing high levels of sensitivity impulses in order to limit the input of pain impulses when they return to the posterior horn of the spinal cord.
PULSE WIDTH	The pulse width varies continuously with this programme. This avoids habituation by using a system of stimulation that is perceived as more pleasant by some patients.
ELECTRODES	The electrodes must be placed on the painful area, preferably on the points of sensitivity.
INTENSITY	The intensity must be increased gradually until the patient feels a tingling sensation that is pronounced without being painful.
+TENS OPTION	No.

TRAPEZIUS PAIN			
FREQUENCY	PULSE WIDTH	MODULATION TIME	TREATMENT TIME
60 Hz	80-200 μ s	3 s	30 min

13. AVAILABLE THERAPY PROGRAMS

CATEGORY	PAIN RELIEF II
PROGRAM	SHOULDER PAIN
WHEN?	To relieve shoulder pain following a mechanical conflict, an inflammatory disorder, shoulder surgery, or inflammatory tendinopathy.
WHY?	For the relief of pain.
HOW?	Using the Gate control principle. This involves causing high levels of sensitivity impulses in order to limit the input of pain impulses when they return to the posterior horn of the spinal cord.
PULSE WIDTH	The pulse width varies continuously with this programme. This avoids habituation by using a system of stimulation that is perceived as more pleasant by some patients.
ELECTRODES	The electrodes must be positioned where the pain is located. Four large electrodes surrounding the joint produce a significant analgesic effect on all shoulder pain.
INTENSITY	The intensity must be increased gradually until the patient feels a tingling sensation that is pronounced without being painful.
+TENS OPTION	No.

SHOULDER PAIN			
FREQUENCY	PULSE WIDTH	MODULATION TIME	TREATMENT TIME
80 Hz	75-180 μ s	3 s	30 min

13. AVAILABLE THERAPY PROGRAMS

CATEGORY	PAIN RELIEF II
PROGRAM	FRACTURE PAIN
WHEN?	In addition to other analgesic treatments during the first few days after a simple immobilisation or osteosynthetic surgery on a fracture. Extended use for rib fractures where strict immobilisation is not possible, resulting in severe pain over several weeks.
WHY?	For the relief of pain.
HOW?	Using the Gate control principle. This involves causing high levels of sensitivity impulses in order to limit the input of pain impulses when they return to the posterior horn of the spinal cord.
PULSE WIDTH	The pulse width for the programme is 170 μ s.
ELECTRODES	Depending on the means of restraint and/or the size of the dressing used, access to the painful area may be awkward. It is important to surround the painful area as much as possible. Another possible strategy is to directly stimulate the large nerve trunks superior to the point of pain.
INTENSITY	The intensity must be increased gradually until the patient feels a tingling sensation that is pronounced without being painful. If the nerve trunks are stimulated, the stimulation should cause the tingling to radiate into the painful area.
+TENS OPTION	No.

FRACTURE PAIN			
FREQUENCY	PULSE WIDTH	MODULATION TIME	TREATMENT TIME
70 Hz	170 μ s	2 s	30 min

13. AVAILABLE THERAPY PROGRAMS

CATEGORY	PAIN RELIEF II
PROGRAM	CERVICAL PAIN
WHEN?	Neck pain most often results from chronic contractures of the levator scapulae muscle and/or the upper trapezius and is due, for example, to non-ergonomic work posture.
WHY?	For pain relief and relaxation of muscle contractures.
HOW?	Endorphin stimulation aids pain relief by increasing production of endogenous opioids. The associated vascular effect results in effective drainage of acidic metabolites and enables the elimination of muscular acidosis.
PULSE WIDTH	Endorphin stimulation first targets the sensitive A δ nerve fibres, which are best stimulated with a larger pulse of 200 μ s. However the vascular effect is secondary to the co-activation of the motor units, which have a slightly higher chronaxy that is measured at the start of the session using the mi-SCAN function.
ELECTRODES	Electrodes positioned according to the specific indication.
INTENSITY	An essential factor in the effectiveness of electrotherapy is the ability to cause visible muscle twitches. The mi-RANGE function can be used to determine the minimum level of energy required to produce an appropriate muscle response.
+TENS OPTION	<p>Yes.</p> <ul style="list-style-type: none"> - A minimum of 1 channel with muscular work imposed by the Disuse atrophy programme. - A maximum of 3 channels with the TENS programme. <ul style="list-style-type: none"> • Electrodes positioned on the painful area. • Sufficient stimulation energy to produce a clear tingling sensation. <p>Once the +TENS combination has been activated, the message "TENS" appears on the screen with respect to the channel or channels where the treatment is active. The mi functions – apart from the mi-SCAN – are also no longer accessible.</p> <p>Take care to properly observe the correct order for switching on the modules, the order of switching on that corresponds to the numbering of the channels.</p>

CERVICAL PAIN LO		
FREQUENCY	PULSE WIDTH	TREATMENT TIME
5 Hz	250 μ s	20 min

13. AVAILABLE THERAPY PROGRAMS

CATEGORY	PAIN RELIEF II
PROGRAM	THORACIC BACK PAIN
WHEN?	Thoracic back pain is most commonly a result of chronic contractures of the paravertebral back muscles (erector spinae) and is, for example, due to spinal osteoarthritis or postures where the spinal muscles remain tense for long periods of time.
WHY?	For pain relief and relaxation of muscle contractures.
HOW?	Endorphin stimulation aids pain relief by increasing production of endogenous opioids. The associated vascular effect results in effective drainage of acidic metabolites and enables the elimination of muscular acidosis.
PULSE WIDTH	Endorphin stimulation first targets the sensitive A δ nerve fibres, which are best stimulated with a larger pulse of 200 μ s. However the vascular effect is secondary to the co-activation of the motor units, which have a slightly higher chronaxy that is measured at the start of the session using the mi-SCAN function.
ELECTRODES	Electrodes positioned according to the specific indication.
INTENSITY	An essential factor in the effectiveness of electrotherapy is the ability to cause visible muscle twitches. The mi-RANGE function can be used to determine the minimum level of energy required to produce an appropriate muscle response.
+TENS OPTION	<p>Yes.</p> <ul style="list-style-type: none"> - A minimum of 1 channel with muscular work imposed by the Disuse atrophy programme. - A maximum of 3 channels with the TENS programme. <ul style="list-style-type: none"> • Electrodes positioned on the painful area. • Sufficient stimulation energy to produce a clear tingling sensation. <p>Once the +TENS combination has been activated, the message "TENS" appears on the screen with respect to the channel or channels where the treatment is active. The mi functions – apart from the mi-SCAN – are also no longer accessible.</p> <p>Take care to properly observe the correct order for switching on the modules, the order of switching on that corresponds to the numbering of the channels.</p>

THORACIC BACK PAIN		
FREQUENCY	PULSE WIDTH	TREATMENT TIME
5 Hz	250 μ s	20 min

13. AVAILABLE THERAPY PROGRAMS

CATEGORY	PAIN RELIEF II
PROGRAM	LOW BACK PAIN
WHEN?	Low back pain most frequently results from chronic contractures of the paravertebral lumbar muscles. It may be caused by a mechanical conflict, vertebral osteoarthritis, disc space narrowing, etc.
WHY?	For pain relief and relaxation of muscle contractures.
HOW?	Endorphin stimulation aids pain relief by increasing production of endogenous opioids. The associated vascular effect results in effective drainage of acidic metabolites and enables the elimination of muscular acidosis. TENS Gate control, applied using the third channel, improves comfort during endorphin stimulation.
PULSE WIDTH	Endorphinic stimulation is primarily aimed at the sensitive A δ nerve fibres which are best stimulated with pulse width of 200 μ s. However the vascular effect is secondary to the co- activation of the motor units which have a slightly higher chronaxy and which is measured at the start of the session using the mi-SCAN function . Channels 3 and 4 provide Gate control stimulation and use a larger pulse adapted to the chronaxy of the A β fibres.
ELECTRODES	Electrodes positioned according to the specific indication. Combining 2 stimulation currents.
INTENSITY	The intensity must first be set on channels 3 and 4, which deliver the TENS programme according to the usual TENS rules (tingling). It will be gradually increased on channels 1 or 2 until visible or palpable muscle twitches are produced. The mi-RANGE function can be used to determine the minimum level of energy required to produce an appropriate muscle response.
+TENS OPTION	<p>Yes.</p> <ul style="list-style-type: none"> - A minimum of 1 channel with muscular work imposed by the Disuse atrophy programme. - A maximum of 3 channels with the TENS programme. <ul style="list-style-type: none"> • Electrodes positioned on the painful area. • Sufficient stimulation energy to produce a clear tingling sensation. <p>Once the +TENS combination has been activated, the message "TENS" appears on the screen with respect to the channel or channels where the treatment is active. The mi functions – apart from the mi-SCAN – are also no longer accessible.</p> <p>Take care to properly observe the correct order for switching on the modules, the order of switching on that corresponds to the numbering of the channels.</p>

13. AVAILABLE THERAPY PROGRAMS

LOWER BACK PAIN		
FREQUENCY	PULSE WIDTH	TREATMENT TIME
5 Hz	250 μ s	20 min

13. AVAILABLE THERAPY PROGRAMS

CATEGORY	PAIN RELIEF II
PROGRAM	LUMBOSCIATICA
WHEN?	Patients with lumbosciatica have lumbar pain which is most commonly caused by chronic contractures of the paravertebral lumbar muscles. In addition, involvement of the spinal nerve root leads to irradiation of pain over a shorter or longer distance along the sciatic nerve and in some cases, along one or the other of its branches (common peroneal or tibial).
WHY?	For pain relief and relaxation of muscle contractures in the lumbar area and to relieve neurogenic sciatic pain.
HOW?	The release of endorphins and the elimination of acidic toxins allow lumbar pain to be treated effectively. The TENS Gate control effect works more specifically on sciatic nerve neuralgia.
PULSE WIDTH	Endorphinic stimulation is primarily aimed at the sensitive A δ nerve fibres which are best stimulated with pulse width of 200 μ s. However the vascular effect is secondary to the co- activation of the motor units, which have a slightly higher chronaxy that is measured at the start of the session using the mi-SCAN function . Channels 2, 3 and 4 provide Gate control stimulation and use a larger pulse adapted to the chronaxy of the A β fibres.
ELECTRODES	Electrodes positioned according to the specific indication. Combining 2 stimulation currents.
INTENSITY	The intensity must first be set on channels 2, 3 and 4, which deliver the TENS programme according to the usual TENS rules (tingling). It will be gradually increased on channel 1 until visible or palpable muscle twitches are produced. The mi-RANGE function can be used to determine the minimum level of energy required to produce an appropriate muscle response.

13. AVAILABLE THERAPY PROGRAMS

CATEGORY	PAIN RELIEF II
+TENS OPTION	<p>Yes.</p> <ul style="list-style-type: none"> - A minimum of 1 channel with muscular work imposed by the Disuse atrophy programme. - A maximum of 3 channels with the TENS programme. <ul style="list-style-type: none"> • Electrodes positioned on the painful area. • Sufficient stimulation energy to produce a clear tingling sensation. <p>Once the +TENS combination has been activated, the message "TENS" appears on the screen with respect to the channel or channels where the treatment is active. The mi functions – apart from the mi-SCAN – are also no longer accessible.</p> <p>Take care to properly observe the correct order for switching on the modules, the order of switching on that corresponds to the numbering of the channels.</p>

LUMBOSCIATICA		
FREQUENCY	PULSE WIDTH	TREATMENT TIME
5 Hz	250 µs	20 min

13. AVAILABLE THERAPY PROGRAMS

CATEGORY	PAIN RELIEF II
PROGRAM	LUMBAGO
WHEN?	This type of treatment is indicated to relieve pain following acute muscle contractures in the low back region. It will also reduce tension in the contracted muscles to facilitate manual handling techniques.
WHY?	To reduce muscular tension and to provide a relaxing effect.
HOW?	Highly individualised muscular twitching that is induced by a very low frequency (1 Hz) has a relaxing effect.
PULSE WIDTH	To make it as comfortable as possible for the patient, use pulse widths equivalent to the chronaxies of the motor nerves of the muscles in the lumbar region. The mi-SCAN function can be used to determine the pulse widths suitable for the patient's muscles.
ELECTRODES	A small electrode, preferably connected to the positive pole is placed on the most painful area of the paravertebral muscles which can be detected by palpation. The other electrode is placed on the same muscles 2 or 3 finger widths away from the first one.
INTENSITY	An essential factor in the therapeutic efficacy is to cause visible muscle twitching, which may, in certain cases, require higher stimulation energies to be used. The mi-RANGE function can be used to determine the minimum level of energy required to produce an appropriate muscle response.
+TENS OPTION	<p>Yes.</p> <ul style="list-style-type: none"> - A minimum of 1 channel with muscular work imposed by the Disuse atrophy programme. - A maximum of 3 channels with the TENS programme. <ul style="list-style-type: none"> • Electrodes positioned on the painful area. • Sufficient stimulation energy to produce a clear tingling sensation. <p>Once the +TENS combination has been activated, the message "TENS" appears on the screen with respect to the channel or channels where the treatment is active. The mi functions – apart from the mi-SCAN – are also no longer accessible.</p> <p>Take care to properly observe the correct order for switching on the modules, the order of switching on that corresponds to the numbering of the channels.</p>

13. AVAILABLE THERAPY PROGRAMS

LUMBAGO		
FREQUENCY	PULSE WIDTH	TREATMENT TIME
1 Hz	250 μ s	20 min

13. AVAILABLE THERAPY PROGRAMS

CATEGORY	PAIN RELIEF II
PROGRAM	EPICONDYLITIS
WHEN?	Epicondylitis is manifested by acute pain located at the point of insertion of the extensor muscles for the wrist and fingers onto the lateral epicondyle. The Epicondylitis programme is used during the acute and inflammatory phase of the complaint. It can also be used for localised pain at the medial epicondyle which results from functional overwork of the flexor muscles (epicondylitis or medial epicondylitis)
WHY?	To relieve pain during the acute and inflammatory phase of the complaint.
HOW?	Using the Gate control principle. This involves causing high levels of tactile sensitivity impulses in order to limit the input of pain impulses when they return to the posterior horn of the spinal cord. For this programme, the frequency is modulated (50-150 Hz) to avoid habituation.
PULSE WIDTH	This programme uses very short duration impulses (50 μ s) suitable for the higher level of excitability of the sensitive A β fibres.
ELECTRODES	Due to the small extent of the painful area, 2 small electrodes are usually sufficient to cover the whole of the desired area.
INTENSITY	The intensity must be increased gradually until the patient feels a tingling sensation that is pronounced without being painful. The mi-TENS function prevents any kind of muscle contraction. If the sensor detects a muscle response, the stimulator automatically reduces the stimulation energy in order to stop the muscle response.
+TENS OPTION	No.

EPICONDYLITIS			
FREQUENCY	PULSE WIDTH	MODULATION TIME	TREATMENT TIME
50-150 Hz	50 μ s	2 s	20 min

13. AVAILABLE THERAPY PROGRAMS

CATEGORY	PAIN RELIEF II
PROGRAM	TORTICOLLIS
WHEN?	This type of treatment is indicated to relieve pain following acute muscle contractures in the neck region. It will also reduce tension in the contracted muscles to facilitate manual handling techniques.
WHY?	To reduce muscular tension and to provide a relaxing effect.
HOW?	Highly individualised muscular twitching that is induced by a very low frequency (1 Hz) has a relaxing effect.
PULSE WIDTH	To make it as comfortable as possible for the patient, use pulse widths equivalent to the chronaxies of the motor nerves of the muscles in the lumbar region. The mi-SCAN function can be used to determine the pulse widths suitable for the patient's muscles.
ELECTRODES	A small electrode, preferably connected to the positive pole is placed on the most painful area which can be detected by palpation. A second electrode is placed on the paravertebral neck muscles.
INTENSITY	An essential factor in the therapeutic efficacy is to cause visible muscle twitching, which may, in certain cases, require higher stimulation energies to be used. The mi-RANGE function can be used to determine the minimum level of energy required to produce an appropriate muscle response.
+TENS OPTION	<p>Yes.</p> <ul style="list-style-type: none"> - A minimum of 1 channel with muscular work imposed by the Disuse atrophy programme. - A maximum of 3 channels with the TENS programme. <ul style="list-style-type: none"> • Electrodes positioned on the painful area. • Sufficient stimulation energy to produce a clear tingling sensation. <p>Once the +TENS combination has been activated, the message "TENS" appears on the screen with respect to the channel or channels where the treatment is active. The mi functions – apart from the mi-SCAN – are also no longer accessible.</p> <p>Take care to properly observe the correct order for switching on the modules, the order of switching on that corresponds to the numbering of the channels.</p>

TORTICOLLIS		
FREQUENCY	PULSE WIDTH	TREATMENT TIME
1 Hz	250 µs	20 min

13. AVAILABLE THERAPY PROGRAMS

CATEGORY	PAIN RELIEF II
PROGRAM	ARTHRALGIA
WHEN?	Various factors such as obesity, age, trauma, poor posture, etc. are detrimental to the joints. These detrimental factors may cause the joints to deteriorate and to become inflamed and painful.
WHY?	To relieve acute and chronic joint pain.
HOW?	The principle is to cause a significant influx of tactile sensitivity in order to restrict the entry of pain impulses upon their return to the posterior horn of the spinal cord. For this programme, the frequency is modulated (50-150 Hz) to avoid habituation.
PULSE WIDTH	This programme uses very short duration impulses (50 μ s) suitable for the higher level of excitability of the sensitive A β fibres.
ELECTRODES	The electrodes are usually placed in such a way as to cover or surround the painful area.
INTENSITY	The intensity must be increased gradually until the patient feels a tingling sensation that is pronounced without being painful. The mi-TENS function prevents any kind of muscle contraction. If the sensor detects a muscle response, the stimulator automatically reduces the stimulation energy in order to stop the muscle response.
+TENS OPTION	No.

ARTHRALGIA			
FREQUENCY	PULSE WIDTH	MODULATION TIME	TREATMENT TIME
50-150 Hz	50 μ s	2 s	20 min

13. AVAILABLE THERAPY PROGRAMS

13.2.6 CONDITIONING II

CATEGORY	CONDITIONING II
PROGRAM	POTENTIATION
WHEN?	For optimal muscle preparation immediately before a competition. The session should be carried out 10 minutes prior to the start.
WHY?	To increase the speed of contraction and increase power. Reduces nervous control to attain or maintain a specified level of exertion.
PULSE WIDTH	To make it as comfortable as possible for the patient, use pulse widths equivalent to the chronaxies of the motor nerves of the muscles being stimulated. The mi-SCAN function can be used to determine the pulse widths suitable for the patient's muscles.
ELECTRODES	Electrodes positioned depending on the muscle to be stimulated, in accordance with the instructions.
INTENSITY	The maximum tolerable stimulation energy, which is one of the key factors determining the effectiveness of the treatment. The higher the stimulation energy, the higher the number of muscle fibres (motor units) being used.
+TENS OPTION	No.

POTENTIATION (3 MIN)				
	WARM UP	CONTRACTION	ACTIVE REST	FINAL RECOVERY PHASE
FREQUENCY	1 Hz	7 peaks*	1 Hz	1 Hz
DURATION OF RAMP-UP	1.5 s	0 s	0 s	1.5 s
DURATION OF PHASE	30 s	7 s	10 s	20 s
DURATION OF RAMP-DOWN	2 s	0 s	0 s	3 s

* Contraction peak Hz: 1) 2-10 2) 2-15 3) 2-20 4) 2-25 5) 2-35 6) 2-45 7) 2-55 8) 2-65 9) 2-75

13. AVAILABLE THERAPY PROGRAMS

CATEGORY	CONDITIONING II
PROGRAM	ENDURANCE
WHEN?	For athletes who wish to improve their performance during long sporting trials/ disciplines.
WHY?	To improve the oxidative capacity of the stimulated muscles and to aid in developing the athlete's aerobic performance.
PULSE WIDTH	To make it as comfortable as possible for the patient, use pulse widths equivalent to the chronaxies of the motor nerves of the muscles being stimulated. The mi-SCAN function can be used to determine the pulse widths suitable for the patient's muscles.
ELECTRODES	Electrodes positioned depending on the muscle to be stimulated, in accordance with the instructions.
INTENSITY	The maximum tolerable stimulation energy, which is one of the key factors determining the effectiveness of the treatment. The higher the stimulation energy, the higher the number of muscle fibres (motor units) being used.
+TENS OPTION	No.

13. AVAILABLE THERAPY PROGRAMS

ENDURANCE, LEVEL 1 (55 MIN)				
	WARM UP	CONTRACTION	ACTIVE REST	FINAL RECOVERY PHASE
FREQUENCY	5 Hz	10 Hz	3 Hz	3 Hz
DURATION OF RAMP-UP	1.5 s	0.5 s	0 s	1.5 s
DURATION OF PHASE	5 min	8 s	2 s	10 min
DURATION OF RAMP-DOWN	2 s	0.5 s	0 s	3 s

ENDURANCE, LEVEL 2 (55 MIN)				
	WARM UP	CONTRACTION	ACTIVE REST	FINAL RECOVERY PHASE
FREQUENCY	5 Hz	12 Hz	3 Hz	3 Hz
DURATION OF RAMP-UP	1.5 s	0.5 s	0 s	1.5 s
DURATION OF PHASE	5 min	8 s	2 s	10 min
DURATION OF RAMP-DOWN	2 s	0.5 s	0 s	3 s

ENDURANCE, LEVEL 3 (55 MIN)				
	WARM UP	CONTRACTION	ACTIVE REST	FINAL RECOVERY PHASE
FREQUENCY	5 Hz	14 Hz	3 Hz	3 Hz
DURATION OF RAMP-UP	1.5 s	0.5 s	0 s	1.5 s
DURATION OF PHASE	5 min	8 s	2 s	10 min
DURATION OF RAMP-DOWN	2 s	0.5 s	0 s	3 s

13. AVAILABLE THERAPY PROGRAMS

CATEGORY	CONDITIONING II
PROGRAM	EXPLOSIVE STRENGTH
WHEN?	For athletes who practise a discipline where explosive strength is a significant performance factor. To increase the maximum capacity for instantaneous power.
WHY?	To increase the speed at which the maximum power is attained and to improve the effectiveness of explosive actions such as jumping, sprinting etc.
PULSE WIDTH	To make it as comfortable as possible for the patient, use pulse widths equivalent to the chronaxies of the motor nerves of the muscles being stimulated. The mi-SCAN function can be used to determine the pulse widths suitable for the patient's muscles.
ELECTRODES	Electrodes positioned depending on the muscle to be stimulated, in accordance with the instructions.
INTENSITY	The maximum tolerable stimulation energy, which is one of the key factors determining the effectiveness of the treatment. The higher the stimulation energy, the higher the number of muscle fibres (motor units) being used.
+TENS OPTION	No.

13. AVAILABLE THERAPY PROGRAMS

EXPLOSIVE STRENGTH, LEVEL 1 (32 MIN)				
	WARM UP	CONTRACTION	ACTIVE REST	FINAL RECOVERY PHASE
FREQUENCY	5 Hz	104 Hz	1 Hz	3 Hz
DURATION OF RAMP-UP	1.5 s	0.75 s	0.5 s	1.5 s
DURATION OF PHASE	5 min	3 s	28 s	10 min
DURATION OF RAMP-DOWN	2 s	0.5 s	0.5 s	3 s

EXPLOSIVE STRENGTH, LEVEL 2 (32 MIN)				
	WARM UP	CONTRACTION	ACTIVE REST	FINAL RECOVERY PHASE
FREQUENCY	5 Hz	108 Hz	1 Hz	3 Hz
DURATION OF RAMP-UP	1.5 s	0.75 s	0.5 s	1.5 s
DURATION OF PHASE	5 min	3 s	29 s	10 min
DURATION OF RAMP-DOWN	2 s	0.5 s	0.5 s	3 s

EXPLOSIVE STRENGTH, LEVEL 3 (34 MIN)				
	WARM UP	CONTRACTION	ACTIVE REST	FINAL RECOVERY PHASE
FREQUENCY	5 Hz	111 Hz	1 Hz	3 Hz
DURATION OF RAMP-UP	1.5 s	0.75 s	0.5 s	1.5 s
DURATION OF PHASE	5 min	3 s	32 s	10 min
DURATION OF RAMP-DOWN	2 s	0.5 s	0.5 s	3 s

13. AVAILABLE THERAPY PROGRAMS

CATEGORY	CONDITIONING II
PROGRAM	PLYOMETRY
WHEN?	To develop muscular explosive power by imposing a stress similar to that induced by voluntary plyometry exercises while reducing stress on joints and tendons.
WHY?	Increase the speed of contraction and the capacity to perform actions at maximum strength (jump, bound, shoot, etc.).
PULSE WIDTH	To make it as comfortable as possible for the patient, use pulse widths equivalent to the chronaxies of the motor nerves of the muscles being stimulated. The mi-SCAN function can be used to determine the pulse widths suitable for the patient's muscles.
ELECTRODES	Electrodes positioned depending on the muscle to be stimulated, in accordance with the instructions.
INTENSITY	The maximum tolerable stimulation energy, which is one of the key factors determining the effectiveness of the treatment. The higher the stimulation energy, the higher the number of muscle fibres (motor units) being used.
+TENS OPTION	No.

13. AVAILABLE THERAPY PROGRAMS

CATEGORY	CONDITIONING II
PROGRAM	HYPERTROPHY
WHEN?	For body-building enthusiasts and athletes wishing to increase their muscle mass. Possibility of combining this programme with voluntary training.
WHY?	Increase the volume of stimulated muscles and improve muscular resistance.
PULSE WIDTH	To make it as comfortable as possible for the patient, use pulse widths equivalent to the chronaxies of the motor nerves of the muscles being stimulated. The mi-SCAN function can be used to determine the pulse widths suitable for the patient's muscles.
ELECTRODES	Electrodes positioned depending on the muscle to be stimulated, in accordance with the instructions.
INTENSITY	The maximum tolerable stimulation energy, which is one of the key factors determining the effectiveness of the treatment. The higher the stimulation energy, the higher the number of muscle fibres (motor units) being used.
+TENS OPTION	No.

13. AVAILABLE THERAPY PROGRAMS

HYPERTROPHY, LEVEL 1 (31 MIN)				
	WARM UP	CONTRACTION	ACTIVE REST	FINAL RECOVERY PHASE
FREQUENCY	5 Hz	45 Hz	8 Hz	3 Hz
DURATION OF RAMP-UP	1.5 s	1.5 s	0 s	1.5 s
DURATION OF PHASE	5 min	4 s	8 s	10 min
DURATION OF RAMP-DOWN	2 s	1 s	0 s	3 s

HYPERTROPHY, LEVEL 2 (32 MIN)				
	WARM UP	CONTRACTION	ACTIVE REST	FINAL RECOVERY PHASE
FREQUENCY	5 Hz	50 Hz	9 Hz	3 Hz
DURATION OF RAMP-UP	1.5 s	1.5 s	0 s	1.5 s
DURATION OF PHASE	5 min	5 s	7 s	10 min
DURATION OF RAMP-DOWN	2 s	1 s	0 s	3 s

HYPERTROPHY, LEVEL 3 (33 MIN)				
	WARM UP	CONTRACTION	ACTIVE REST	FINAL RECOVERY PHASE
FREQUENCY	5 Hz	55 Hz	10 Hz	3 Hz
DURATION OF RAMP-UP	1.5 s	1.5 s	0 s	1.5 s
DURATION OF PHASE	5 min	6 s	6 s	10 min
DURATION OF RAMP-DOWN	2 s	1 s	0 s	3 s

13. AVAILABLE THERAPY PROGRAMS

CATEGORY	CONDITIONING II
PROGRAM	MUSCLE BUILDING
WHEN?	For those who wish to improve overall muscle quality in balance with a discrete effect on increasing muscular volume.
WHY?	To improve muscular trophicity, and increase the tone and volume of the muscles in a balanced way.
PULSE WIDTH	To make it as comfortable as possible for the patient, use pulse widths equivalent to the chronaxies of the motor nerves of the muscles being stimulated. The mi-SCAN function can be used to determine the pulse widths suitable for the patient's muscles.
ELECTRODES	Electrodes positioned depending on the muscle to be stimulated, in accordance with the instructions.
INTENSITY	The maximum tolerable stimulation energy, which is one of the key factors determining the effectiveness of the treatment. The higher the stimulation energy, the higher the number of muscle fibres (motor units) being used.
+TENS OPTION	No.

13. AVAILABLE THERAPY PROGRAMS

MUSCLE BUILDING, LEVEL 1 (23 MIN)				
	WARM UP	CONTRACTION	ACTIVE REST	FINAL RECOVERY PHASE
FREQUENCY	6 Hz	40 Hz	4 Hz	3 Hz
DURATION OF RAMP-UP	1.5 s	1.5 s	0.5 s	1.5 s
DURATION OF PHASE	2 min	5 s	10 s	3 min
DURATION OF RAMP-DOWN	2 s	0.75 s	0.5 s	3 s

MUSCLE BUILDING, LEVEL 2 (25 MIN)				
	WARM UP	CONTRACTION	ACTIVE REST	FINAL RECOVERY PHASE
FREQUENCY	6 Hz	45 Hz	4 Hz	3 Hz
DURATION OF RAMP-UP	1.5 s	1.5 s	0.5 s	1.5 s
DURATION OF PHASE	2 min	6 s	9 s	3 min
DURATION OF RAMP-DOWN	2 s	0.75 s	0.5 s	3 s

MUSCLE BUILDING, LEVEL 3 (26 MIN)				
	WARM UP	CONTRACTION	ACTIVE REST	FINAL RECOVERY PHASE
FREQUENCY	6 Hz	50 Hz	4 Hz	3 Hz
DURATION OF RAMP-UP	1.5 s	1.5 s	0.5 s	1.5 s
DURATION OF PHASE	2 min	7 s	8 s	3 min
DURATION OF RAMP-DOWN	2 s	0.75 s	0.5 s	3 s

13. AVAILABLE THERAPY PROGRAMS

CATEGORY	CONDITIONING II
PROGRAM	LOW BACK REINFORCEMENT
WHEN?	The low back muscles play an important role in protecting the lumbar region. Some sporting activities, such as rowing, require specific work from the low back muscles.
WHY?	Improve the active stability and contraction qualities of the lumbar region. This programme enables these muscles to be worked in an intense and isolated manner in order to maintain and improve the strength of the low back muscles.
PULSE WIDTH	To make it as comfortable as possible for the patient, use pulse widths equivalent to the chronaxies of the motor nerves of the muscles being stimulated. The mi-SCAN function can be used to determine the pulse widths suitable for the patient's muscles.
ELECTRODES	Place the electrodes on the paravertebral muscles of the low back area.
INTENSITY	The maximum tolerable stimulation energy, which is one of the key factors determining the effectiveness of the treatment. The higher the stimulation energy, the higher the number of muscle fibres (motor units) being used.
+TENS OPTION	No.

13. AVAILABLE THERAPY PROGRAMS

LOWER BACK REINFORCEMENT, LEVEL 1 (33 MIN)				
	WARM UP	CONTRACTION	ACTIVE REST	FINAL RECOVERY PHASE
FREQUENCY	5 Hz	40 Hz	4 Hz	3 Hz
DURATION OF RAMP-UP	1.5 s	1.5 s	0.5 s	1.5 s
DURATION OF PHASE	5 min	5 s	10 s	10 min
DURATION OF RAMP-DOWN	2 s	0.75 s	0.5 s	3 s

LOWER BACK REINFORCEMENT, LEVEL 2 (35 MIN)				
	WARM UP	CONTRACTION	ACTIVE REST	FINAL RECOVERY PHASE
FREQUENCY	5 Hz	45 Hz	4 Hz	3 Hz
DURATION OF RAMP-UP	1.5 s	1.5 s	0.5 s	1.5 s
DURATION OF PHASE	5 min	6 s	9 s	10 min
DURATION OF RAMP-DOWN	2 s	0.75 s	0.5 s	3 s

LOWER BACK REINFORCEMENT, LEVEL 3 (36 MIN)				
	WARM UP	CONTRACTION	ACTIVE REST	FINAL RECOVERY PHASE
FREQUENCY	5 Hz	50 Hz	4 Hz	3 Hz
DURATION OF RAMP-UP	1.5 s	1.5 s	0.5 s	1.5 s
DURATION OF PHASE	5 min	7 s	8 s	10 min
DURATION OF RAMP-DOWN	2 s	0.75 s	0.5 s	3 s

13. AVAILABLE THERAPY PROGRAMS

CATEGORY	CONDITIONING II
PROGRAM	CORE STABILISATION
WHEN?	The abdominal muscles and the muscles in the low back area are very important for all sporting activities. Good neuromuscular control and stabilisation of the trunk are essential for the optimal positioning of the lumbar spine and to ensure the effective transmission of strength in any complex movement.
WHY?	Increase postural control of the trunk muscles. May be combined with or supplement active dynamic exercises.
PULSE WIDTH	To make it as comfortable as possible for the patient, use pulse widths equivalent to the chronaxies of the motor nerves of the muscles being stimulated. The mi-SCAN function can be used to determine the pulse widths suitable for the patient's muscles.
ELECTRODES	Place the electrodes on the paravertebral muscles of the low back region and on the abdominal muscles.
INTENSITY	The maximum tolerable stimulation energy, which is one of the key factors determining the effectiveness of the treatment. The higher the stimulation energy, the higher the number of muscle fibres (motor units) being used.
+TENS OPTION	No.

13. AVAILABLE THERAPY PROGRAMS

CORE STABILISATION, LEVEL 1 (33 MIN)				
	WARM UP	CONTRACTION	ACTIVE REST	FINAL RECOVERY PHASE
FREQUENCY	5 Hz	40 Hz	4 Hz	3 Hz
DURATION OF RAMP-UP	1.5 s	1.5 s	0.5 s	1.5 s
DURATION OF PHASE	5 min	5 s	10 s	10 min
DURATION OF RAMP-DOWN	2 s	0.75 s	0.5 s	3 s

CORE STABILISATION, LEVEL 2 (35 MIN)				
	WARM UP	CONTRACTION	ACTIVE REST	FINAL RECOVERY PHASE
FREQUENCY	5 Hz	45 Hz	4 Hz	3 Hz
DURATION OF RAMP-UP	1.5 s	1.5 s	0.5 s	1.5 s
DURATION OF PHASE	5 min	6 s	9 s	10 min
DURATION OF RAMP-DOWN	2 s	0.75 s	0.5 s	3 s

CORE STABILISATION, LEVEL 3 (36 MIN)				
	WARM UP	CONTRACTION	ACTIVE REST	FINAL RECOVERY PHASE
FREQUENCY	5 Hz	50 Hz	4 Hz	3 Hz
DURATION OF RAMP-UP	1.5 s	1.5 s	0.5 s	1.5 s
DURATION OF PHASE	5 min	7 s	8 s	10 min
DURATION OF RAMP-DOWN	2 s	0.75 s	0.5 s	3 s

13. AVAILABLE THERAPY PROGRAMS

CATEGORY	CONDITIONING II
PROGRAM	RECOVERY PLUS
WHEN?	To promote muscle recuperation following an exhausting exertion that caused cramps or is likely to induce them when the activity is stopped.
WHY?	To increase blood flow to drain away toxins that have accumulated in the muscles. To relieve and/ or prevent aching pains. To promote muscle relaxation. To accelerate restoration of the muscular qualities following a workout or competition.
PULSE WIDTH	To make it as comfortable as possible for the patient, use pulse widths equivalent to the chronaxies of the motor nerves of the muscles being stimulated. The mi-SCAN function can be used to determine the pulse widths suitable for the patient's muscles.
ELECTRODES	Precision in positioning the electrodes is less significant than for programmes aiming to develop muscle quality. The electrodes can be placed in an alternative way, reducing the number of electrodes needed and stimulating more muscles during a session.
INTENSITY	An essential factor in the effectiveness of electrotherapy is the ability to cause visible muscle twitches. The mi-RANGE function can be used to determine the minimum level of energy required to produce an appropriate muscle response.
+TENS OPTION	No.

RECOVERY PLUS (25 MIN)				
	1ST SEQUENCE	2ND SEQUENCE	3RD SEQUENCE	4TH SEQUENCE
FREQUENCY	2 Hz	4 Hz	6 Hz	5 Hz
TIME	2 min	2 min	4 min	4 min
	5TH SEQUENCE	6TH SEQUENCE	7TH SEQUENCE	8TH SEQUENCE
FREQUENCY	4 Hz	3 Hz	2 Hz	1 Hz
TIME	4 min	3 min	3 min	3 min

13. AVAILABLE THERAPY PROGRAMS

CATEGORY	CONDITIONING II
PROGRAM	TONING MASSAGE
WHEN?	Specific massage programme that includes some short muscle contractions. This programme can supplement traditional heating or even replace it if traditional heating is difficult to use.
WHY?	Activates circulation and revives of the contractile properties of the muscles.
PULSE WIDTH	To make it as comfortable as possible for the patient, use pulse widths equivalent to the chronaxies of the motor nerves of the muscles being stimulated. The mi-SCAN function can be used to determine the pulse widths suitable for the patient's muscles.
ELECTRODES	Electrodes positioned depending on the muscle to be stimulated, in accordance with the instructions.
INTENSITY	Gradually increase the stimulation energy until there is clear visible muscle twitching. During the tetanic contraction phases, ensure that the energy stimulation is sufficient to impose significant muscle contractions.
+TENS OPTION	No.

TONING MASSAGE (29 MIN)				
	1ST SEQUENCE	2ND SEQUENCE	3RD SEQUENCE	4TH SEQUENCE
VIBRATIONS WITH FREQ. MODULATION 1-8 HZ	➔	-	➔	-
CONTRACTION / RELAXTION	-	10 reps ➔	-	8 reps ➔
	5TH SEQUENCE	6TH SEQUENCE	7TH SEQUENCE	8TH SEQUENCE
VIBRATIONS WITH FREQ. MODULATION 1-8 HZ	-	➔	-	➔
CONTRACTION / RELAXTION	7 reps ➔	-	6 reps ➔	-

13. AVAILABLE THERAPY PROGRAMS

CATEGORY	CONDITIONING II
PROGRAM	RELAXING MASSAGE
WHEN?	To eliminate uncomfortable or painful sensations resulting from an exaggerated increase in muscle tone.
WHY?	To allow a decrease in muscle tension. To drain away the toxins responsible for the increase in muscle tone. The programme produces a sense of well being and relaxation.
PULSE WIDTH	To make it as comfortable as possible for the patient, use pulse widths equivalent to the chronaxies of the motor nerves of the muscles being stimulated. The mi-SCAN function can be used to determine the pulse widths suitable for the patient's muscles.
ELECTRODES	Precision in positioning the electrodes is less significant than for programmes aiming to develop muscle quality. The electrodes can be placed in an alternative way, reducing the number of electrodes needed and stimulating more muscles during a session.
INTENSITY	An essential factor in the effectiveness of electrotherapy is the ability to cause visible muscle twitches. The mi-RANGE function can be used to determine the minimum level of energy required to produce an appropriate muscle response.
+TENS OPTION	No.

RELAXING MASSAGE (21 MIN)			
	1ST SEQUENCE	2ND SEQUENCE	3RD SEQUENCE
FREQUENCY	7 Hz	5 Hz	3 Hz
TIME	7 min	7 min	7 min

13. AVAILABLE THERAPY PROGRAMS

CATEGORY	CONDITIONING II
PROGRAM	ANTI-STRESS MASSAGE
WHEN?	This programme can be used for relaxation and well-being after physical activity or a stressful situation. It provides very effective muscle relaxation through comfortable stimulation of the muscles, which aids circulation and helps the muscles relax.
WHY?	Increases vascularisation of the tissues, reduces muscle tension.
PULSE WIDTH	To make it as comfortable as possible for the patient, use pulse widths equivalent to the chronaxies of the motor nerves of the muscles being stimulated. The mi-SCAN function can be used to determine the pulse widths suitable for the patient's muscles.
ELECTRODES	Precision in positioning the electrodes is less significant than for programmes aiming to develop muscle quality. The electrodes can be placed in an alternative way, reducing the number of electrodes needed and stimulating more muscles during a session.
INTENSITY	An essential factor in the effectiveness of electrotherapy is the ability to cause visible muscle twitches. The mi-RANGE function can be used to determine the minimum level of energy required to produce an appropriate muscle response.
+TENS OPTION	No.

13. AVAILABLE THERAPY PROGRAMS

ANTI-STRESS MASSAGE (21 MIN)				
	1ST SEQUENCE	2ND SEQUENCE	3RD SEQUENCE	4TH SEQUENCE
FREQUENCY	3 Hz	2 Hz	1 Hz	Freq. mod. 1-6 Hz
TIME	2 min	1 min	30 s	40 s
	5TH SEQUENCE	6TH SEQUENCE	7TH SEQUENCE	8TH SEQUENCE
FREQUENCY	Freq. mod. 1-3 Hz	1 Hz	Freq. mod. 1-6 Hz	1 Hz
TIME	30 s	30 s	90 s	30 s
	9TH SEQUENCE	10TH SEQUENCE	11TH SEQUENCE	12TH SEQUENCE
FREQUENCY	Freq. mod. 1-3 Hz	1 Hz	1 Hz	1 Hz intensity decrease
TIME	90 s	30 s	30 s	-

 These 3 sequences loop 5 times

 These 4 sequences loop 2 times

14. HOW TO USE THE WIRELESS PROFESSIONAL ON SPECIFIC INDICATIONS

14.1 Overview

Indication	Page
Disuse atrophy rehabilitation (standard protocol)	211
Rehabilitation of the peroneus muscles following an ankle sprain	213
Rehabilitation of low back muscles	216
Treatment of patellofemoral syndrome	219
1. Lateral tracking	219
2. Post-traumatic condition	222
ACL ligamentoplasty	224
Rehabilitation of the gluteal muscles following total hip replacement	228
Rehabilitation of the shoulder	230
1. Rotator cuff tendinopathy	231
2. Shoulder instability	235
3. Adhesive capsulitis	238
Cardiac rehabilitation	241
Reflex sympathetic dystrophy (or Complex regional pain syndrome)	244
Endorphinic treatment of Rachialgia and Radiculalgia	249
1. Endorphinic treatment of neck pain	251
2. Endorphinic treatment of thoracic back pain	253
3. Endorphinic treatment of low back pain	255
4. Treatment of lumbosciatic pain	258
Hemiplegia – Spasticity	261
1. Dorsiflexion of the hemiplegic foot	262
2. Spasticity	264
3. The hemiplegic hand	268
4. The hemiplegic shoulder	270

14. HOW TO USE THE WIRELESS PROFESSIONAL ON SPECIFIC INDICATIONS

Indication	Page
Treatment of venous insufficiency	273
1. Venous insufficiency without oedema	273
2. Venous insufficiency with oedema	275
Treatment of arterial insufficiency in the lower limbs	278
1. Stage II arterial insufficiency	279
2. Stage III arterial insufficiency	281

14. HOW TO USE THE WIRELESS PROFESSIONAL ON SPECIFIC INDICATIONS

14.2 Disuse atrophy rehabilitation (standard protocol)

Example: disuse atrophy of the quadriceps

Traumas of the locomotive system can be extremely diverse (fractures, sprains, dislocations, etc.) and have varied functional repercussions.

Despite immense progress in orthopaedic medicine, it is still common practice to have a period of immobilisation of the area concerned, which can be total or partial.

The result is always a significant reduction, in the normal activity of the muscles in the traumatised region. The rapid disuse atrophy which occurs (reduction in the muscle volume and the muscle tissue's ability to contract) can sometimes compromise the functional future of the patient.

The physiological mechanisms involved in the alteration of the different muscle fibres under such circumstances are well-known, and therefore extremely specific treatments can be proposed, which can produce optimum benefits on their own.

This standard protocol is recommended for the majority of cases of functional disuse atrophy. However, this protocol can be adapted depending on the pathology, the treatment objectives and the speed of the patient's recovery.

14.2.1 Protocol

Weeks 1 – 2: Disuse atrophy Level 1

During the first two weeks of treatment, the following 3 objectives must be worked towards and achieved:

- Eliminate muscle wastage.
- Familiarise the patient with the NMES technique so that the patient can work with high levels of stimulation energy.
- Obtain the first signs of regain of trophicity (slight increase in volume, improvement in tone).

Weeks 3 – 6: Disuse atrophy Level 2

The objective is the restoration of near-normal muscle volume.

Weeks 7 – 8: Reinforcement Level 1

The objective is to develop the maximum strength the muscle or muscle group can produce.

14.2.2 Treatment frequency

One to two sessions every day (if two sessions are carried out every day, enough time must be given to rest between the two sessions).

Minimum: three sessions per week.

14. HOW TO USE THE WIRELESS PROFESSIONAL ON SPECIFIC INDICATIONS

14.2.3 Electrode position

During neurostimulation for motor stimulation purposes, the general rule is to position a small electrode on the motor point of the muscle and the other electrode at one end of the same muscle.

For optimum effectiveness, the positive electrode should preferably be positioned on the motor point.

The precise location of the motor point(s) is easy to ascertain by following the instructions for the indication “Locating a motor point” in this manual.

This step ensures that the electrodes will be positioned to provide optimum comfort to the patient and optimum effectiveness of the therapy.

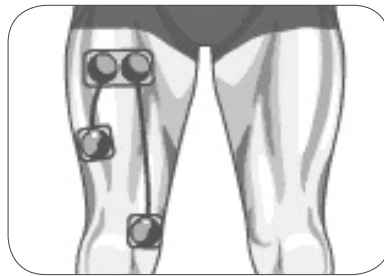

14.2.4 Patient position

The stimulation of a muscle when it is at its maximum inner range is uncomfortable and quickly becomes painful due to the sensation of cramp that results from this position. Consequently, this position must be avoided and the patient should be placed in a position in which the stimulated muscle is in a mid-range position. The end of the stimulated limb must be securely tied down so that the electrically induced contraction does not cause any movement.

The stimulation will therefore be carried out using isometric contractions.

14. HOW TO USE THE WIRELESS PROFESSIONAL ON SPECIFIC INDICATIONS

14.2.5 Stimulation energy

In NMES, the stimulation energy is directly responsible for spatial recruitment: the higher the stimulation energy, the higher the percentage of motor units recruited and the greater the impact of the progress. The general rule is to always try to increase the energy to the maximum level tolerated by the patient. The therapist plays a fundamental role by encouraging and reassuring the patient, who can then tolerate levels of energy that produce powerful contractions. The levels of energy reached must increase throughout the session, and also from session to session, because the patients quickly get used to the technique.

When the patient has difficulty in reaching satisfactory levels of stimulation energy, it can be useful to ask the patient to add voluntary co-contractions, which improves mediocre spatial recruitment and also makes the stimulation more comfortable.

The levels of energy can then be gradually increased over time.

For this, the mi-ACTION is a useful tool, because it requires the patient to contract his/her muscle voluntarily to initiate and/or accompany the electrically induced contraction depending on the given set-point.

14.3 Rehabilitation of the peroneus muscles following an ankle sprain

The purpose of the peroneus muscles is to maintain the stability of the talocrural joint and prevent the ankle from rotating inwards.

Following a sprain, due to the functional disability, reflex inhibition phenomena and immobilisation, these muscles can undergo partial disuse atrophy, a loss of proprioceptive reflexes and a considerable loss of strength.

Rehabilitation following such an accident must therefore focus essentially on the peroneus muscles in order to prevent recurrences.

To fulfil their function optimally, the peroneus muscles must effectively put up resistance to brief and powerful stresses. They must therefore be capable of responding with a powerful, short contraction at that very moment when the stress being applied to the foot risks making the ankle tilt inwards.

There are therefore two main aspects of the rehabilitation of these muscles:

1. The proprioceptive reflex:

Allows the peroneus muscles to sense the lower limb position relative to neighbouring parts and to contract at the right moment with an appropriate strength effort.

This aspect of rehabilitation consists of properly performing exercises on classic "balance boards", such as Freeman boards, a sufficient number of times (number of sessions).

14. HOW TO USE THE WIRELESS PROFESSIONAL ON SPECIFIC INDICATIONS

2. Muscle reinforcement:

Allows the peroneus muscles to contract with enough strength to oppose the stress applied to the ankle joint.

This aspect of rehabilitation consists of producing peroneus muscle contractions using electro-stimulation and using programmes designed for developing explosive force. Only this method is really capable of developing the strength of these muscles effectively, given the impossibility of feasibly being able to carry out active methods with this level of load!

14.3.1 Protocol

Treatment at an early stage:

- Weeks 1 – 2: Reinforcement Level 1
- Weeks 3 – 4: Reinforcement Level 2

Treatment at a late stage:

- Weeks 1 – 2: Disuse atrophy Level 2
- Weeks 3 – 4: Reinforcement Level 1
- Weeks 5 – 6: Reinforcement Level 2

If the patient is experiencing associated pain symptoms, TENS stimulation can be performed in addition on the other channels.

In this case, the specific practical rules for TENS (electrode placement, regulation of intensity) should be followed for each channel used for this purpose.

14.3.2 Treatment frequency

Three sessions per week, right after the proprioceptive session, or alternating one day on, one day off.

14. HOW TO USE THE WIRELESS PROFESSIONAL ON SPECIFIC INDICATIONS

14.3.3 Electrode position

A single channel is enough for the stimulation of the peroneus muscles.

A small electrode is placed under the head of the fibula, at the passage of the Common Peroneal nerve.

The large electrode is placed mid-way up the external lateral side of the leg.

For optimum effectiveness, the positive electrode should preferably be positioned on the motor point.

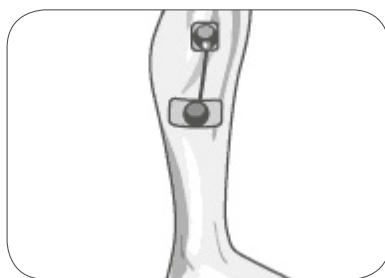

14.3.4 Patient position

First of all, the patient is seated on the rehabilitation table, barefoot and without touching the floor.

In this position, the therapist gradually increases the stimulation energy until a motor response is manifested by an eversion of the foot.

As soon as this response is obtained (most often after 2 or 3 contractions), the barefoot patient is put into standing position.

This position is particularly useful because it requires an associated proprioceptive effort, which can be of increasing difficulty (two feet, one foot, balance board, etc.)

14.3.5 Stimulation energy

In NMES, the stimulation energy is directly responsible for spatial recruitment: the higher the stimulation energy, the higher the percentage of motor units recruited and the greater the impact of the progress.

The general rule is to always try to increase the energy to the maximum level tolerated by the patient.

The therapist plays a fundamental role by encouraging and reassuring the patient, who can then tolerate levels of energy that produce powerful contractions.

The levels of energy reached must increase throughout the session, and also from session to session, because the patients quickly get used to the technique.

14. HOW TO USE THE WIRELESS PROFESSIONAL ON SPECIFIC INDICATIONS

14.4 Rehabilitation of low back muscles

Muscular insufficiency of the muscles that provide stability of the lumbar region is often the cause of common low back pain or identified as a contributing factor, which increases the risk of recurrence.

The particular benefit of electrostimulation is three-fold:

- It enables treatment to be started at an early stage because, unlike voluntary exercises, the stress applied to the stabilising muscles in the lumbar region through electrostimulation is initially carried out in isometric mode, which considerably reduces the mechanical stresses exerted on the vertebral and periarticular structures.
- It enables an appropriate work regime to be created to restore the quality of the postural muscles, i.e. the muscles that are essentially made up of type I, high-endurance fibres.
- It promotes motor re-learning and postural control by combining synchronised, electrically induced contractions of the abdominal and lumbar muscles with voluntary proprioception exercises.

14.4.1 Protocol

Weeks 1 – 2: Lumbar stabilisation Level 1

Weeks 3 – 4: Lumbar stabilisation Level 2

14.4.2 Treatment frequency

Three to five sessions a week for four weeks.

14. HOW TO USE THE WIRELESS PROFESSIONAL ON SPECIFIC INDICATIONS

14.4.3 Electrode position

Two channels are needed for the stimulation of the abdominal muscles:

Four large electrodes are positioned on the abdomen, one above, one below and one either side of the belly button.

For optimum effectiveness, the positive pole should preferably be positioned on the upper electrode.

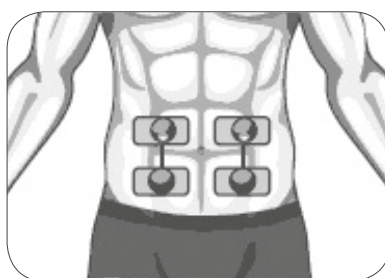

Two further channels are needed for the simultaneous stimulation of the lumbar muscles, one for the right side and the other for the left side.

Two small electrodes are placed on the muscle body at the level of the lowest lumbar vertebrae at one finger's breadth distance from the spinous processes on both sides. Two small electrodes are placed 2 finger's breadths above the body of the paravertebral muscles.

For optimum effectiveness, the positive pole should preferably be positioned on the lower electrodes.

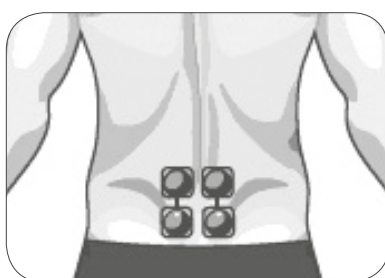

14.4.4 Patient position

For the first two weeks:

The patient is seated on a firm seat, with the forearms resting on armrests and a straight back, without leaning against the back of the chair.

For the following two weeks:

The patient is seated on a balance ball, feet resting on the ground, pelvis width apart.

14. HOW TO USE THE WIRELESS PROFESSIONAL ON SPECIFIC INDICATIONS

14.4.5 Associated exercises

For the first two weeks:

On each contraction induced by the stimulation, the patient must:

- Breathe out slowly
- Pull in the stomach
- Elongate the body along its axis

The patient then returns to the starting position during the rest phase and slowly breathes in.

For the following two weeks:

The basis of the exercises stays the same: combine an electrically-induced contraction with breathing out, pulling in the stomach and elongating the body.

Depending on the patient's progress, the following can gradually be added to the exercises:

- Additional movement of an upper limb: lifting up an arm
- Additional movement of a lower limb: taking one foot off the floor
- Quick movements of two upper limbs: throwing and catching a ball
- etc.

14.4.6 Stimulation energy

In NMES, the stimulation energy is directly responsible for spatial recruitment: the higher the stimulation energy, the higher the percentage of motor units recruited and the greater the impact of the progress.

The general rule is to always try to increase the energy to the maximum level tolerated by the patient.

The therapist plays a fundamental role by encouraging and reassuring the patient, who can then tolerate levels of energy that produce powerful contractions.

The levels of energy reached must increase throughout the session, and also from session to session, because the patients quickly get used to the technique.

14. HOW TO USE THE WIRELESS PROFESSIONAL ON SPECIFIC INDICATIONS

14.5 Treatment of patellofemoral syndrome

A distinction must be made between two types of patellofemoral syndrome:

1. With patellar mal tracking, which means the patella is not running centrally in the trochlear groove, commonly being pulled laterally.
2. Without patellar mal tracking, i.e. with a centred patellofemoral syndrome, as in post-traumatic chondropathy.

The proposed protocols are based mostly on the studies carried out by Dr. Gobelet (University Hospital of Lausanne, Switzerland, Physical Medicine Department) and by Dr. Drhezen (College of Physiotherapy, Liège, Belgium).

14.5.1 Lateral tracking

An essential cause of the mal tracking, of the patella is determined by an imbalance between the different heads of the quadriceps muscle.

A particularly significant weakness of the vastus medialis in comparison with the vastus lateralis creates a lateral displacement of the patella with hyperpressure between the lateral condyle and the adjacent retropatella surface.

Specific reinforcement of the vastus medialis is the ideal way to treat this pathology. It can be enhanced effectively with electrostimulation.

14.5.1.1 Protocol

Weeks 1 – 2: Patellofemoral syndrome Level 2

Weeks 3 – 4: Patellofemoral syndrome Level 3

If the patient is experiencing associated pain symptoms, TENS stimulation can be performed in addition on the other channels.

In this case, the specific practical rules for TENS (electrode placement, regulation of intensity) should be followed for each channel used for this purpose.

14.5.1.2 Treatment frequency

Three sessions per week.

14. HOW TO USE THE WIRELESS PROFESSIONAL ON SPECIFIC INDICATIONS

14.5.1.3 Electrode position

Only one channel is used.

- Place a small electrode on the distal motor point of the vastus medialis, which innervates the oblique fibres.
- A second electrode is placed at the upper end of the vastus medialis at around mid-thigh level.

For optimum effectiveness, the positive pole should preferably be positioned on the lower electrode corresponding to the distal motor point of the vastus medialis.

This placement of electrodes makes it possible to focus contraction of the vastus medialis, which cannot be achieved during voluntary exercises.



14.5.1.4 Patient position

The focused contraction of the vastus medialis moves the patella upward and inward, thus re-centring the kneecap and reducing the joint stresses in the lateral compartment of the knee.

This makes it possible to place the patient in a sitting position with the knee bent at 60 – 90° in order to apply high stimulation energies to the vastus medialis.

During stimulation, the patient's ankle will be tied firmly to the chair or the medical table on which he/she is seated.

In case the patient finds this position painful, the first sessions will be carried out with the knee in full extension.

After this, we will try to gradually put the knee in a flexed position.

14. HOW TO USE THE WIRELESS PROFESSIONAL ON SPECIFIC INDICATIONS

14.5.1.5 Stimulation energy

In NMES, the stimulation energy is directly responsible for spatial recruitment: the higher the stimulation energy, the higher the percentage of motor units recruited and the greater the impact of the progress. The general rule is to always try to increase the energy to the maximum level tolerated by the patient. The therapist plays a fundamental role by encouraging and reassuring the patient, who can then tolerate levels of energy that produce powerful contractions.

The levels of energy reached must increase throughout the session, and also from session to session, because the patients quickly get used to the technique.

With this programme, the stimulation starts directly with a tetanic contraction, because the warm-up phase has been eliminated so as not to produce muscle twitches that are likely to cause unwanted microtraumas to the kneecap.

14. HOW TO USE THE WIRELESS PROFESSIONAL ON SPECIFIC INDICATIONS

14.5.2 Post-traumatic condition

Repeated traumas to the knee joint, like those caused by the practice of certain sports, may entail cartilaginous lesions of the kneecap.

These lesions can lead to pain of varying intensity and the occurrence of reflex inhibition, which in turn can result in disuse atrophy of the entire quadriceps. The resulting insufficiency of the quadriceps negatively affects the active stability of the joint and increases pain.

This vicious circle can be interrupted through electrostimulation of the quadriceps using the Patellofemoral syndrome programme, the parameters of which are specially adapted to avoid any unwanted effects on the kneecap.

However, for irreversible cartilaginous lesions, it is always recommended that the benefits obtained should be maintained through maintenance treatments.

The protocol detailed below is also suitable for the rehabilitation of patello femoral atrophosies.

14.5.2.1 Protocol

- Week 1: Patellofemoral syndrome Level 1
- Weeks 2 – 3: Patellofemoral syndrome Level 2
- Week 4 then maintenance: Patellofemoral syndrome Level 3

If the patient is experiencing associated pain symptoms, TENS stimulation can be performed in addition on the fourth channel.

In this case, the specific practical rules for TENS (electrode placement, regulation of intensity) should be followed for this channel.

14.5.2.2 Treatment frequency

Five sessions per week during the first four weeks.

Then one session per week to maintain the results after week four.

14. HOW TO USE THE WIRELESS PROFESSIONAL ON SPECIFIC INDICATIONS

14.5.2.3 Electrode position

In this programme, 3 stimulation channels are used for the quadriceps.

This is because of the need to work with the knee extended in order not to cause excessive pressure on the posterior side of the patella.

Indeed, this position places the quadriceps in inner range, which is not generally favourable to electrostimulation techniques, since, in this position, the patient very often feels the contraction as being uncomfortable and even painful (cramp sensation).

The use of high stimulation energies that ensure significant spatial recruitment can be difficult to achieve in some patients.

The third stimulation channel overcomes this disadvantage by optimising spatial recruitment and therefore the effectiveness of the treatment.

- Three small electrodes are placed respectively on the motor points of the vastus medialis, the vastus lateralis and the rectus femoris.
- A large, two-way electrode is placed at the top of the thigh and a further small electrode is positioned just above.

For optimum effectiveness, the positive pole should preferably be positioned on the motor point.

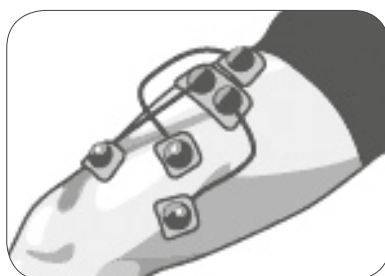

14.5.2.4 Patient position

For this indication, it is recommended to carry out the session with the patient's knee extended.

14.5.2.5 Stimulation energy

In NMES, the stimulation energy is directly responsible for spatial recruitment: the higher the stimulation energy, the higher the percentage of motor units recruited and the greater the impact of the progress.

The general rule is to always try to increase the energy to the maximum level tolerated by the patient. The therapist plays a fundamental role by encouraging and reassuring the patient, who can then tolerate levels of energy that produce powerful contractions. The levels of energy reached must increase throughout the session, and also from session to session, because the patients quickly get used to the technique.

With this programme, the stimulation starts directly with a tetanic contraction, because the warm-up phase has been eliminated so as not to produce muscle twitches that are likely to cause unwanted microtraumas to the kneecap.

14. HOW TO USE THE WIRELESS PROFESSIONAL ON SPECIFIC INDICATIONS

14.6 ACL ligamentoplasty

Ruptures of the Anterior Cruciate Ligament (ACL) of the knee are among the most common accidents in sports trauma.

Reconstructive surgery of the ACL has been subject to continuous developments in recent decades, with considerable progress, in particular owing to the use of arthroscopic techniques.

Associated with the improvement in the rehabilitation treatment of injured athletes, the return time to athletic activity continues to decrease significantly, and today is practically half what it was around ten years ago.

The return to athletic activity requires both satisfactory solidity of the tendon graft, which must be capable of supporting significant mechanical stresses, and, more importantly, good active joint stability.

This active joint stability requires muscles capable of opposing sometimes phenomenal stresses in the shortest time periods possible, by activating the proprioceptive reflex.

One of the potential consequences of the operative procedure is significant disuse atrophy of the quadriceps muscles, the treatment of which is one of the primary objectives of the rehabilitation therapist. However, during the first 3 - 4 months of quadriceps rehabilitation, there must be no open kinetic chain exercises due to the anterior drawer component of the tibia, which can endanger the tendon graft during the avascularisation phase.

The method described in this chapter is intended to describe an NMES protocol suitable for this particular problem of ACL ligamentoplasty, avoiding any risk of a secondary lesion to tissue.

This safety is ensured by using specific ACL programmes that consist of appropriate sequential stimulation of the quadriceps and hamstrings.

Note

This particular stimulation mode does not allow for work with mi-ACTION.

For ligamentoplasty using the patellar tendon as the graft, the NMES can be started promptly. When using doubled semitendinosus and gracilis tendons for ligamentoplasty, NMES must not be used before the standard healing period of these tendons.

14. HOW TO USE THE WIRELESS PROFESSIONAL ON SPECIFIC INDICATIONS

14.6.1 Protocol

Weeks 1 – 16: ACL

During the **first two weeks** of treatment, the following 3 objectives must be worked towards and achieved:

- Eliminate muscle wastage.
- Familiarise the patient with the NMES technique so that the patient can work with high levels of stimulation energy.
- Obtain the first signs of regaining trophicity (slight increase in volume, improvement in tone, etc.).

During **the following weeks**, the objective is the restoration of near-normal muscle volume.

When open kinetic chain exercises are permitted, which is normally **at the end of the fourth month** after the operation, NMES of the quadriceps can be continued using the Reinforcement programmes Level 1 then 2.

14.6.2 Treatment frequency

One to two sessions every day (if two sessions are carried out every day, enough time must be given to rest between the two sessions).

Minimum: three sessions per week.

14. HOW TO USE THE WIRELESS PROFESSIONAL ON SPECIFIC INDICATIONS

14.6.3 Electrode position

The stimulation sequence means that the order of channel numbers must be complied with, as the stimulation of the hamstrings must start before that of the quadriceps.

Channels 1 and 2 are used to stimulate the hamstrings, and channels 3 and 4 are used to stimulate the quadriceps.

For this program, it is therefore particularly important to follow the order of channel.

For each muscle group, it is recommended that the small electrodes be placed precisely on the motor points, as shown in the illustration, or better yet, that the motor points be found using the instructions for the indication "Locating a motor point" in this manual.

For optimum effectiveness, the positive pole should preferably be positioned on the motor point.

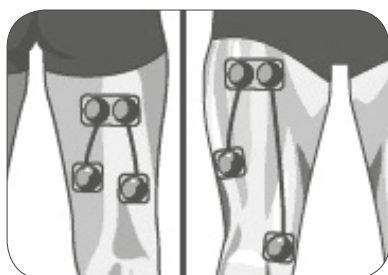

14.6.4 Patient position

The very first sessions, the primary objective of which is to eliminate muscle wastage, can be performed with the lower limb extended, with a small cushion placed under the popliteal fossa.

For the subsequent sessions, the patient will be placed in a sitting position with the knee bent at a comfortable angle. After satisfactory recovery of joint mobility, the knee is ideally bent between 60 and 90°.

14. HOW TO USE THE WIRELESS PROFESSIONAL ON SPECIFIC INDICATIONS

14.6.5 Stimulation energy

As always in NMES, the objective of the rehabilitation therapist is to motivate the patient to tolerate the highest possible stimulation energy level.

With the ACL programmes, and taking into account the particular sequential stimulation mode, it is not possible to adjust the energy levels of channels 3 and 4 without having previously increased levels on channels 1 and 2.

This is an additional safety feature that prevents contraction of the quadriceps if it is not preceded by contraction of the hamstrings.

As usual, a patient who tries to work with the maximum energies he/she is capable of tolerating will reach higher energy levels for channels 3 and 4 (quadriceps) than for channels 1 and 2 (hamstrings).

14. HOW TO USE THE WIRELESS PROFESSIONAL ON SPECIFIC INDICATIONS

14.7 Rehabilitation of the gluteal muscles following total hip replacement

Orthopaedic surgery to the hip and, in particular, the fitting of a prosthesis, results in disuse atrophy of the gluteus muscles with loss of strength in the active stability of the hip when standing on one foot and walking.

In addition to active physiotherapy exercises, neuromuscular electrical stimulation of the gluteus maximus and medius is a technique particularly indicated for the effective treatment of weakness in these muscles.

It is recommended to start treatment as soon as possible after the operation.

The very low frequency sequences such as the warm-up, active rest between tetanic contractions and final recovery phase at the end of the treatment sequences generate individualized muscle twitches producing vibration in the prosthetic material.

The three levels of the Hip prosthesis programme correspond respectively to the programmes:

- Disuse atrophy, Level 1
- Disuse atrophy, Level 2 and
- Reinforcement, Level 1,

from which the very low frequencies are removed.

The three levels of the Hip prosthesis programme therefore induce only tetanic contraction phases separated by complete rest phases.

14.7.1 Protocol

- Week 1: Hip prosthesis Level 1
- Weeks 2 – 3: Hip prosthesis Level 2
- Week 4: Hip prosthesis Level 3

If the patient is experiencing associated pain symptoms, TENS stimulation can be performed in addition on the other channels.

In this case, the specific practical rules for TENS (electrode placement, regulation of intensity) should be followed for each channel used for this purpose.

14.7.2 Treatment frequency

Once daily, 5 days per week, for 4 weeks.

14. HOW TO USE THE WIRELESS PROFESSIONAL ON SPECIFIC INDICATIONS

14.7.3 Electrode position

Two channels are used, one for stimulation of the gluteus maximus and the other for the gluteus medius.

- A small electrode is placed at the intersection of the orthogonal axes dividing the buttock into four quadrants with the same area (motor point of the gluteus maximus).
- A second small electrode is placed above and outside of the upper external quadrant of the buttock on the gluteus medius at the point where it passes over the gluteus maximus.

For optimum effectiveness, the positive pole should preferably be positioned on the motor point.

The other negative poles are connected to the two outputs of one large electrode positioned diagonally in the lower-lateral quadrant of the buttock, taking care to avoid placing this electrode on a scarred/wounded area.

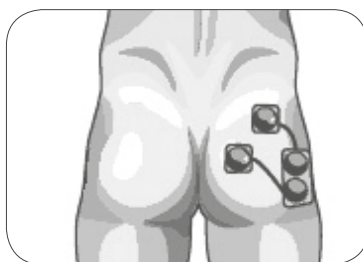

14.7.4 Patient position

If the patient's condition allows, the patient is placed in a standing position, which requires him/ her to exert additional effort that is beneficial for proprioceptive control.

If this is not possible, all or part of the session can be conducted in a side lying or prone position.

14.7.5 Stimulation energy

In NMES, the stimulation energy is directly responsible for spatial recruitment: the higher the stimulation energy, the higher the percentage of motor units recruited and the greater the impact of the progress. The general rule is to always try to increase the energy to the maximum level tolerated by the patient. The therapist plays a fundamental role by encouraging and reassuring the patient, who can then tolerate levels of energy that produce powerful contractions. The levels of energy reached must increase throughout the session, and also from session to session, because the patients quickly get used to the technique. With this programme, the stimulation starts directly with a tetanic contraction, because the warm-up phase has been eliminated so as not to produce muscle twitches that are likely to cause unwanted vibrations on the prosthesis.

14. HOW TO USE THE WIRELESS PROFESSIONAL ON SPECIFIC INDICATIONS

14.8 Rehabilitation of the shoulder

The “specific properties” of the shoulder joint are complex and particularly demanding at a functional level. The shoulder must be capable of providing significant mobility of the upper limb whilst providing a stable base.

The limited congruence of the joint surfaces (the humeral head within the glenoid cavity), although partially compensated by the labrum, exposes the joint to misalignment that the passive capsular/ligament elements cannot control.

Neuromuscular control must constantly compensate for the deficiencies in passive stability by maintaining coordinated forces capable of opposing the unstable component resulting from intrinsic forces (contraction of muscles generating translational forces: pectoralis major, biceps brachii, coracobrachialis, triceps brachii (caput longum), or extrinsic forces (fall, contact, etc.).

Owing to the numerous advances in the fields of biomechanics, physiology and physiopathology, the therapeutic approach to shoulder pathologies has evolved considerably in recent years.

In this chapter, we will discuss three pathological conditions of the shoulder, for which neuromuscular electrostimulation is a preferred treatment among the established rehabilitation techniques.

These three conditions are:

1. Rotator cuff tendinopathy
2. Shoulder instability
3. Adhesive capsulitis

The protocols proposed have been developed on the basis of the following publications:

- Flatow EL, Soslowky LJ, Ateshian GA, Pawluk RJ, Bigliani LU, Mow VC: Shoulder joint anatomy and the effect of subluxations and size mismatch on patterns of glenohumeral contact.; Orthop Trans 15: 803; 1991
- Harryman DT, Sidles JA, Clark JM, McQuade KJ, Gibbs TD, Matsen FA: Translation of the humeral head on the glenoid with passive glenohumeral motion; J Bone Joint Surg 72A: 1334; 1990
- Matsen F, Lippit S, Iserin A; Mécanismes patho-anatomiques de l'instabilité gléno-humérale ['Pathoanatomical mechanisms of glenohumeral instability'] 'Expansion scientifique française', Paris, Cahier d'enseignement de la SOFCOT [Teaching book of the French Society of Orthopaedic Surgery], pp 7 – 13
- Gibb TD, Sidles JA, Harryman DT, McQuade KJ, Matsen FA; The effect of capsular venting on glenohumeral laxity; Clin Orthop 268: 120 – 6; 1991
- Howell SM, Galinat BJ; The glenoid-labral socket. A constrained articular surface. Clin Orthop 243: 122; 1989
- Itoi E, Motzkin NE, Morrey BF, An KN; Bulk effect of rotator cuff on inferior glenohumeral stability as

14. HOW TO USE THE WIRELESS PROFESSIONAL ON SPECIFIC INDICATIONS

function of scapular inclination angle: a cadaver study; Tohoku J Exp Med 171 (4): 267 – 76; 1993

14.8.1 Rotator cuff tendinopathy

The anatomical location of the rotator cuff exposes it in particular to significant stress and rotator cuff tendinopathy therefore constitutes a real public health problem. A study conducted in the United Kingdom in 1986 showed that 20% of the population has consulted a doctor for shoulder problems. The pathogenesis of these cases of tendinopathy is associated with multiple factors: intrinsic factors (vascularisation deficiency, structural abnormality of collagen fibres, etc.) or extrinsic factors (excessive mechanical stress, kinematic defects, etc.), sometimes combined, these can be considered as causes of tendon dysfunctions.

Kinematic defects appear to play an important role, and most often involve limitations in range of motion, pain phenomena and functional constraint. The limitations in range of motion observed in specific tests involve flexion (elevation) and/or abduction.

A limitation in flexion shows anterosuperior misalignment, while a limitation in abduction shows misalignment in medial rotation spin. Recovery of range of motion is obtained after correction of the joint misalignment, which must be performed using appropriate techniques. Neuromuscular control work must be focused on the coordination muscles, the muscles depressing the humeral head and the lateral rotators. The priority given for many years to the latissimus dorsi and pectoralis major muscles is strongly disputed today due to the medial rotation component of these muscles.

In fact, the only muscles enabling these mechanical requirements to be satisfied are the supraspinous and infraspinous muscles, which neuromotor rehabilitation, including electrostimulation, will focus on as a primary objective.

14.8.1.1 Protocol

Phase 1: TENS (and Decontracture if required)

Phase 2: Rotator cuff Level 1 + TENS (in case of persistent pain)

Phase 3: Rotator cuff Level 2 + (mi-ACTION mode)

14. HOW TO USE THE WIRELESS PROFESSIONAL ON SPECIFIC INDICATIONS

14.8.1.2 Treatment frequency

Phase 1:

One to several consecutive TENS sessions for the first to third initial treatments, before performing the manual joint realignment techniques.

In case of hypertonicity of the pectoralis major muscle, a session can be carried out using the Decontracture programme on the pectoralis major muscle to reduce excessive muscular tension that could impede the medial spin correction techniques.

Phase 2:

Three to five sessions per week until the pain disappears

Phase 3:

Three to five sessions per week until the end of treatment

When the patient has recovered good motor control of the stabilizing muscles, it is beneficial to perform the last sessions of the treatment in mi-ACTION mode. When this function is active, the initiation of the electrically induced contraction requires voluntary contraction on the part of the patient. For this exercise, it is recommended that the mi-sensor be positioned on the electrode placed on the infraspinous muscle and to ask the patient to perform a voluntary isometric contraction of his/her lateral rotators.

14.8.1.3 Electrode position

Phase 1

Four large electrodes are placed in such a way as to cover the whole shoulder as well as possible.

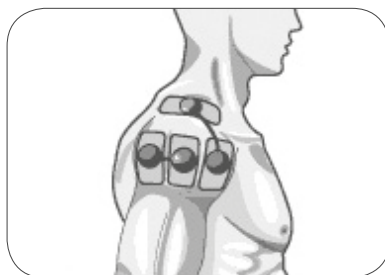

Phase 2

A small electrode is placed on the fleshiest part of the infraspinous fossa and the other small electrode is positioned on the external part of the supraspinous fossa but not over rear deltoid as this result in unwanted shoulder extension. For optimum effectiveness, the positive pole should preferably be positioned on the infraspinous muscle.

If the patient is still experiencing pain, TENS can be combined using the other channels. The specific placement of electrodes for TENS used for phase 1 will be applied to channels 2 and 3.

14. HOW TO USE THE WIRELESS PROFESSIONAL ON SPECIFIC INDICATIONS

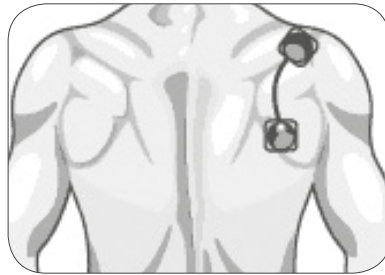

And, in case of persistent pain:



Phase 3

Continuation of the stimulation of the supraspinous and infraspinous muscles. The electrodes are positioned in the same way as for phase 2.

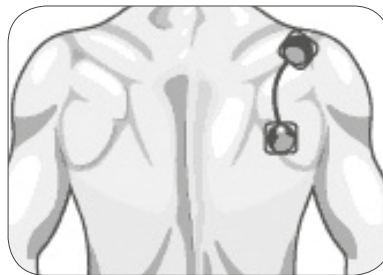

14.8.1.4 Patient position

The patient is seated with the arm against his/her body, the forearm and the hand resting on an armrest, the upper limb is placed in the reference position with neutral rotation. In phases 2 and 3, and on the condition that the position remains painless, the arm can gradually be placed in slight abduction, not exceeding 30°.

14. HOW TO USE THE WIRELESS PROFESSIONAL ON SPECIFIC INDICATIONS

14.8.1.5 Stimulation energy

Phase 1:

The stimulation energy must be gradually increased to obtain a clear tingling sensation.

Phase 2 and 3:

The stimulation energy must be gradually increased to the patient's maximum sub-painful threshold for the stimulation of the infraspinous and supraspinatus muscles (channel 1) and until they experience a tingling sensation for the channels using TENS (phase 2 in case of associated pain).

14. HOW TO USE THE WIRELESS PROFESSIONAL ON SPECIFIC INDICATIONS

14.8.2 Shoulder instabilities

Shoulder instabilities are one of the most common pathologies, and their treatment remains a difficult challenge.

Trauma, repeated microtraumas or a constitutional laxity can compromise the stability of the shoulder either by injuring the passive structures (distension or tear of the inferior glenohumeral ligament, detachment of the labrum, progressive stretching of the capsule, etc.) or by disturbing the motor systems, causing a reduction in the coordination component resulting from the action of the scapular and scapulohumeral muscles.

The supra- and infraspinous muscles are the main coordination muscles of the glenohumeral joint; however, their efficacy is reinforced by the tone and muscle mass of the deltoid.

Unlike in the rehabilitation of rotator cuff tendinopathy, in which the work of the deltoid must be prescribed due to the subacromial interference, combined muscular electrostimulation of the deltoid and the supra- and infraspinous muscles is beneficial in this case because it allows for the stabilising musculature of the shoulder to be optimised.

14.8.2.1 Protocol

Phase 1: Disuse atrophy Level 1 until full, painless mobility is obtained

Phase 2: Disuse atrophy Level 2 until there is no pain during physical examination

Phase 3: Disuse atrophy Level 2 (+ mi-ACTION mode). Stimulation of the infra- and supraspinous muscles combined with voluntary proprioception exercises until the recovery of strength and endurance corresponding to functional requirements.

14.8.2.2 Treatment frequency

Three to five sessions per week.

14. HOW TO USE THE WIRELESS PROFESSIONAL ON SPECIFIC INDICATIONS

14.8.2.3 Electrode position

Phases 1 and 2:

Three channels for stimulation of the deltoid and the spinal muscles.

For the deltoid:

- one small electrode is placed on the anterior bundle of the deltoid and another small electrode is placed on the middle bundle.
- a large two-way electrode is placed on the shoulder above the acromion.

For optimum effectiveness, the positive poles should preferably be positioned on the small electrodes.

For the spinal muscles:

- a small electrode is placed on the fleshiest part of the infraspinous fossa connected to the positive pole.
- a small electrode is positioned at the external part of the supraspinous fossa connected to the negative pole but not over the rear deltoid.

For optimum effectiveness, the positive pole should preferably be positioned on the infraspinous muscle.

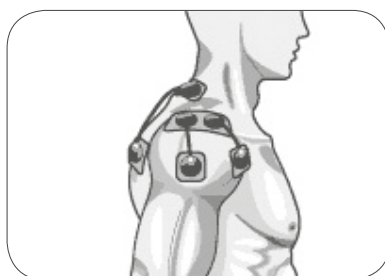

Phase 3:

- A small electrode is placed on the fleshiest part of the infraspinous fossa and
- The other small electrode is positioned on the external part of the supraspinous fossa.

For optimum effectiveness, the positive pole should preferably be positioned on the infraspinous muscle.

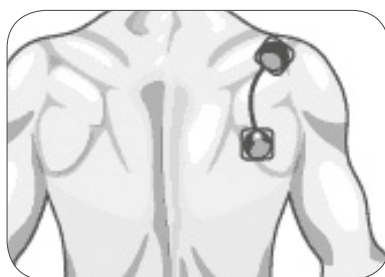

14. HOW TO USE THE WIRELESS PROFESSIONAL ON SPECIFIC INDICATIONS

14.8.2.4 Patient position

Phases 1 and 2:

The first stimulation sessions are conducted on a patient seated, with the upper limb in the reference position, the forearm resting on an armrest.

In subsequent sessions, the arm will gradually be placed in increasing abduction to 60°. The patient's position during stimulation should prevent any stress on the scar tissue and should always remain painless.

Phase 3:

The stimulation of the infra- and supraspinous muscles can be performed simultaneously with active work, such as, for example, proprioception exercises.

The patient can be placed in the push-up position, with the hands resting on a trampoline. In this position, he/she is asked to bounce in time with the phase of electrically induced contraction of the spinal muscles. This exercise is always performed after warm-up and will first be performed with two-handed support, then one-handed support.

The mi-ACTION function can be used to greatly facilitate the combination of voluntary exercises with the stimulation.

14.8.2.5 Stimulation energy

The stimulation energy must be gradually increased to the maximum of the patient's sub-painful threshold.

14. HOW TO USE THE WIRELESS PROFESSIONAL ON SPECIFIC INDICATIONS

14.8.3 Adhesive capsulitis

The SECEC (European Society for Surgery of the Shoulder and the Elbow) gives the following clinical definition for retractile capsulitis: limited active and passive mobility, by a minimum of 30%, in the 3 planes, for more than 3 months.

This limitation results from the thickening (inspissation) and fibrosis of the joint capsule with recess disappearance, which translates into a loss of active and passive shoulder mobility.

This affliction is idiopathic in a third of cases, but in the other two thirds there is a prior shoulder pathology that can be of a highly variable nature (shoulder trauma, shoulder surgery, hemiplegia, subacromioncoracoid impingement, etc.). The diabetic population is particularly at risk, with 20% of this population presenting capsulitis at some stage. Note that the initial development is a reflex sympathetic dystrophy (even if this does not exactly conform with a strict definition of the term, since it essentially affects the limb extremities); this reflex sympathetic dystrophy then regresses as the capsule fibrosis and the joint ankylosis develops.

Clinically, we see the development of a first entirely painful acute phase, then the shoulder gradually loses mobility as the pain recedes; then, the shoulder is just stiff and painless. At this point there is a loss of active and passive mobility affecting especially the abduction and external rotation of the shoulder (external rotation is reduced to at least 50% compared to the healthy side).

There is spontaneous evolution towards recovery for a period of time that varies from 3 months to 2 years, depending essentially on the quality of the rehabilitation treatment used.

The objectives of rehabilitation are first to relieve pain in the acute phase, and then to restore the biomechanical and neuromuscular qualities of the shoulder.

14.8.3.1 Protocol

Phase 1 (Acute phase): TENS

The criterion for moving from phase 1 to phase 2 is achieving a shoulder that is not painful at rest. Clinical examination often exposes a set of symptoms similar to those of rotator cuff tendinopathy, for which the same therapeutic approach can be used. This clinical presentation is the result of the compensatory mechanisms established during the acute phase.

Phase 2: Disuse atrophy Level 1, then Disuse atrophy Level 2.

14.8.3.2 Treatment frequency

Three to five sessions per week.

14. HOW TO USE THE WIRELESS PROFESSIONAL ON SPECIFIC INDICATIONS

14.8.3.3 Electrode position

Phase 1:

Four large electrodes are placed in such a way as to cover the whole shoulder as well as possible.

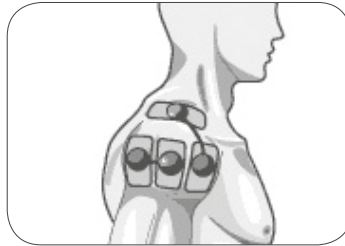

Phase 2:

One stimulation channel for the infraspinous and supraspinous muscles.

- One small electrode is placed on the fleshiest part of the infraspinous fossa.
- The other small electrode is positioned on the external part of the supraspinous fossa.

For optimum effectiveness, the positive pole should preferably be positioned on the infraspinous muscle.

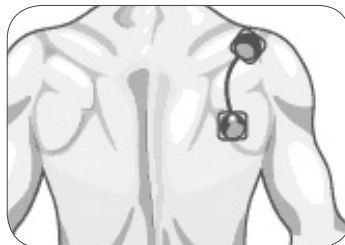

14.8.3.4 Patient position

Phase 1:

The patient is placed in the most comfortable position for him or her.

Phase 2:

The patient is seated with the arm against his/her body, the forearm and the hand resting on an armrest, the upper limb is placed in the reference position with neutral rotation. In phase 2, and on the condition that the position remains painless, the arm can gradually be placed in slight abduction, not exceeding 30°.

14. HOW TO USE THE WIRELESS PROFESSIONAL ON SPECIFIC INDICATIONS

14.8.3.5 Stimulation energy

Phase 1:

The stimulation energy must be gradually increased to obtain a clear tingling sensation.

Phase 2:

The stimulation energy must be gradually increased to the maximum threshold the patient can tolerate.

14. HOW TO USE THE WIRELESS PROFESSIONAL ON SPECIFIC INDICATIONS

14.8.4 Cardiac Rehabilitation

Chronic heart failure causes functional impairment associated with the intricate physiopathological mechanisms involved between the cardiac dysfunction and the peripheral changes associated with a deconditioning syndrome.

The skeletal muscle abnormalities are morphological and functional. They include a reduction in muscle mass, a reduction in slow-twitch type I fibres and a reduction in capillary density.

Metabolically, the muscle changes are characterised by a reduction in the density of the mitochondria and a reduction in the mitochondrial oxidative capacity.

Appropriate physical exercise, which improves one's capacity for exertion, is known to be one of the essential components in the treatment of chronic heart failure.

However, some patients are excluded from the cardiac rehabilitation programmes due to the severity of their cardiac condition or due to co-morbidities limiting the practice of physical exercise. It is because of this that neuromuscular electrostimulation has been proposed as an alternative or complementary treatment to physical exercise for heart failure, as it enables muscular performance and capacity for exertion to be improved.

The protocols proposed have been developed on the basis of the following publications:

1. Karavidas A, Arapi SM, Pyrgakis V, Adamopoulos S.

Functional electrical stimulation of lower limbs in patients with chronic heart failure.

Heart Fail Rev. 2010 Nov;15(6):563-79. Review

2. Banerjee P, Clark A, Witte K, Crowe L, Caulfield B.

Electrical stimulation of unloaded muscles causes cardiovascular exercise by increasing oxygen demand.

Eur J Cardiovasc Prev

Rehabil 2005 ; 12: 503-508

3. Quittan M, Wiesinger G, Sturm B, et al.

Improvement of thigh muscles by neuromuscular electrical stimulation in patients with refractory heart failure.

Am J Phys Med Rehabil 2001;80(3): 206-214

4. Maillefert JF, Eicher JC, Walker P et al.

Effects of low-frequency electrical stimulation of quadriceps and calf muscles in patients with chronic heart failure.

J Cardiopulm Rehabil 1998;18(4): 277-282

5. Deley G, Kervio G, Verges B et al.

Comparison of low-frequency electrical myostimulation and conventional aerobic exercise training in patients with chronic heart failure.

Eur J Cardiovasc Prev Rehabil 2005 ;12(3): 226-233

14. HOW TO USE THE WIRELESS PROFESSIONAL ON SPECIFIC INDICATIONS

14.8.4.1 Protocol

Cardiac rehabilitation.

14.8.4.2 Treatment frequency

Three to six sessions a week for four to eight weeks.

14.8.4.3 Electrode position

The quadriceps are the priority muscles due to their functional importance and their high volume of muscle mass.

Two channels are needed per thigh for quadriceps stimulation.

- Two small electrodes are placed on the motor points of the vastus medialis and the vastus lateralis.
- Two large electrodes are positioned at the top of the thigh.

For optimum effectiveness, the positive pole should preferably be positioned on the motor point.

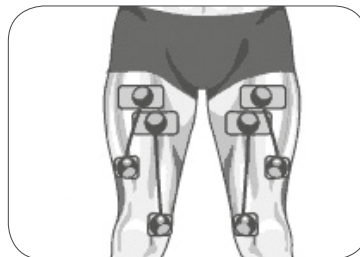

14.8.4.4 Patient position

The patient should preferably be placed in a sitting position with his/her knees bent at approximately 90°, the ankles must be restrained to avoid the knees from being extended, which can induce contractions. If the patient is not able to stay seated, the session can be carried out in a lying position, taking care to place a large cushion under the popliteal fossae so that the knees are flexed.

14. HOW TO USE THE WIRELESS PROFESSIONAL ON SPECIFIC INDICATIONS

14.8.4.5 Stimulation energy

In NMES, the stimulation energy is directly responsible for spatial recruitment: the higher the stimulation energy, the higher the percentage of motor units recruited and the greater the impact of the progress. The general rule is to always try to increase the energy to the maximum level tolerated by the patient. The therapist plays a fundamental role by encouraging and reassuring the patient, who can then tolerate levels of energy that produce powerful contractions. The levels of energy reached must increase throughout the session, and also from session to session, because the patients quickly get used to the technique.

14. HOW TO USE THE WIRELESS PROFESSIONAL ON SPECIFIC INDICATIONS

14.9 Reflex sympathetic dystrophy (or Complex regional pain syndrome)

Reflex sympathetic dystrophy (RSD) is a disease that physiotherapists frequently see and which they must be able to diagnose and treat at an early stage.

The protocols proposed have been developed on the basis of the following publications:

1. Abram S, Asiddao C, Reynolds A,
Increased Skin Temperature during Transcutaneous Electrical Stimulation. *Anesthesia and Analgesia* 59: 22 - 25, 1980
2. Owens S, Atkinson R, Lees DE,
Thermographic Evidence of Reduced Sympathetic Tone with Transcutaneous Nerve Stimulation. *Anesthesiology* 50: 62 - 65, 1979
3. Owens S, Atkinson R, Lees DE,
Thermographic Evidence of Reduced Sympathetic Tone with Transcutaneous Nerve Stimulation. *Anesthesiology* 50: 62 - 65, 1979
4. Abram S,
Increased Sympathetic Tone Associated with Transcutaneous Electrical Stimulation. *Anesthesiology* 45: 575 - 577, 1976
5. Meyer GA, Fields HL,
Causalgia treated by selective large fibre stimulation of peripheral nerve. *Brain* 9: 163 - 168, 1972

Diagnostic / definition

RSD is a complication which most often occurs following a trauma. In most cases, this trauma is to the bone or joints of the limbs. The type of trauma is generally a fracture or operation, but may also involve dislocations, wounds, burns, phlebitis, infections, etc.

RSD does not start immediately after the trauma or the operation, but appears some time later. In general, it starts when physiotherapy begins.

This is why the role of the physiotherapist is vital.

The main sign of RSD is pain. The pain is most often located at the end of the traumatised limb. It is described by the patient as a burning pain. The intensity of the pain is high and often disproportionate to the initial trauma. It increases with stress and activity and decreases when the patient is calm and resting. Mobilisation and massage accentuate it; simply touching the skin may be very painful.

14. HOW TO USE THE WIRELESS PROFESSIONAL ON SPECIFIC INDICATIONS

Depending on the stage of development, other signs may appear:

- The skin becomes cold with sweating, oedema and cyanosis developing in the more advanced stages.
- The muscles in the affected area become atrophied.
- The underlying bone develops osteoporosis (Sudeck's atrophy).

The precise mechanism of development of RSD is not yet exactly known. However, it is well established that the sympathetic nervous system plays a major role.

Indeed, vasomotor disorders associated with hyperactivity of the orthosympathetic system innervating the region concerned have been observed.

Treatment

There are two aspects to the treatment of RSD: the relief of pain and the reduction in the activity of the orthosympathetic system.

However, mobilisations, massages and all techniques likely to cause or accentuate the pain must be ruled out, as they could potentially aggravate the RSD.

Few therapeutic methods meet these criteria, which makes transcutaneous electrical nerve stimulation (TENS) the first treatment of choice available to physiotherapists for treating RSD.

However, it is essential here to limit the stimulation to the myelinated nerve fibres of the tactile sensory system only, the type A β fibres, as these are the only fibres which have an inhibiting affect on the orthosympathetic system. This is not the case for the other nerve fibres (A δ , B, C), as these activate this orthosympathetic nervous system.

This selective targeting of the A β fibres, which are the most excitable nerve fibres (tactile sensory system), is possible if very short pulse widths ($\leq 50 \mu\text{s}$) are used, i.e. the TENS programme.

14.9.1 Protocol

TENS 1: for very sensitive or hyperalgesic patients

TENS 2: for all other patients

14.9.2 Treatment frequency

A minimum of 20 to 40 minutes of treatment every day.

14. HOW TO USE THE WIRELESS PROFESSIONAL ON SPECIFIC INDICATIONS

14.9.3 Electrode position

Use three channels

- Two channels are used with four large electrodes to cover the painful area.
- The third channel uses small electrodes to excite the nerve path(s) supplying the extremity of the limb concerned.

Upper limb:

Distal RSD of the upper limb:

- Four large electrodes are used to cover the palms and backs of the hand and fingers.
- Two small electrodes a finger's width apart are placed as high as possible on the inner side of the arm; the upper electrode is thus positioned at the level of the brachial wall of the axilla.

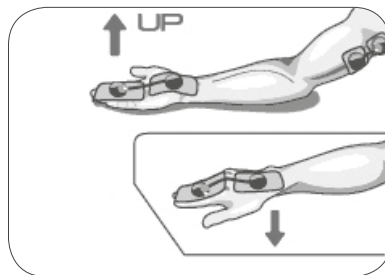

RSD of the shoulder:

- Four large electrodes are used to cover the whole shoulder.
- A small electrode is placed at the level of the supraclavicular cavity, and another small electrode is positioned on the bony protrusion of the acromion.

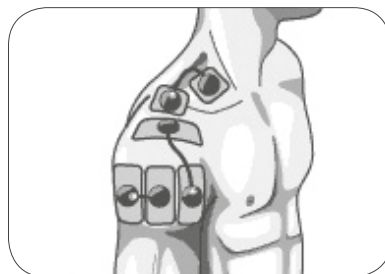

14. HOW TO USE THE WIRELESS PROFESSIONAL ON SPECIFIC INDICATIONS

Lower limb:

Distal RSD of the lower limb:

- Four large electrodes are used to surround the ankle and foot.
- A small electrode is placed in the middle of the popliteal fossa; another small electrode is placed similarly one finger's breadth above.

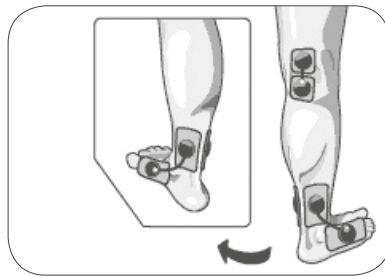

RSD of the knee:

- Four large electrodes are used to cover the knee and surround the kneecap.
- A small electrode is placed at the level of the inguinal fossa just beside the femoral artery, and another small electrode is placed similarly one finger's breadth above it.

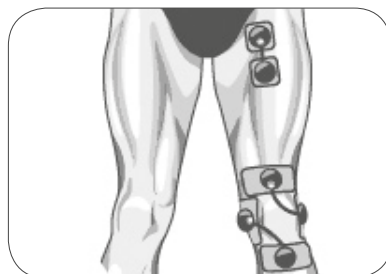

14.9.4 Patient position

The most comfortable position for the patient.

To improve the irradiation of the tingling sensation caused by neural stimulation, it is recommended to exert a slight pressure on the small electrodes placed on the nerve being targeted (bag of sand weighing 1 or 2 kg, cushion placed between the chest and arm, etc.)

14. HOW TO USE THE WIRELESS PROFESSIONAL ON SPECIFIC INDICATIONS

14.9.5 Stimulation energy

The stimulation energy must first be adjusted on the third channel, which stimulates the target nerve at the axilla, supraclavicular, popliteal or inguinal regions. The energy level is gradually increased until the patient feels paresthesia (tingling) at the end of the limb being treated.

Then, the energy level is adjusted on the other two channels so that the patient feels an increase in the tingling sensation.

During the session, because of the habituation phenomenon, the sensation of paresthesia will gradually be reduced and even disappear. It is then recommended that the energy be increased slightly to maintain the sensation, but without causing muscle contractions.

The mi-TENS function eliminates this possibility by automatically reducing the stimulation energy to below the motor excitation threshold.

14. HOW TO USE THE WIRELESS PROFESSIONAL ON SPECIFIC INDICATIONS

14.10 Endorphinic treatment of Rachialgia and Radiculalgia

This chapter deals with the analgesic treatment of spinal pain (Rachialgia) and nerve root pain (Radiculalgia).

The practical methods of treatment described in this chapter are based on the following reference publications:

1. Holtt V., Przewlocki R., Herz A.
Radioimmunoassay of beta-endorphin basal and stimulated levels in extracted rat plasma. *Naunyn Schmiedebergs Arch Pharmacol* 1978; 303 (2): 171 - 174
2. Viru A., Tenzegolskis Z.
Plasma endorphin species during dynamic exercise in humans. *Clin Physiol* 1995; 15 (1): 73 - 79
3. Pierce E.F., Eastman N.W., Tripathi H.T., Olson K.G., Dewey W.L.
Plasma beta-endorphin immunoreactivity: response to resistance exercise. *J Sports Sci* 1993; 11 (6): 499 - 452
4. Dzampaeva E.T.
Hearing loss correction by endogenous opioid stimulation. *Vestn Otorinolaringol* 1998; (3): 13 - 16
5. Ulett G.A., Han S., Han J.S.
Electroacupuncture: mechanisms and clinical application. *Biol Psychiatry* 1998; 44 (2): 129 - 138
6. Wang H.H., Chang Y.H., Liu D.M., Ho Y.J.
A clinical study on physiological response in electroacupuncture analgesia and meperidine analgesia for colonoscopy. *Am J Chin Med* 1997; 25 (1): 13 - 20
7. Chen B.Y., Yu J.
Relationship between blood radioimmunoreactive beta-endorphin and hand skin temperature during the electroacupuncture induction of ovulation. *Acupunct Electrother Res* 199; 16 (1 - 2): 1 - 5
8. Boureau F., Luu M. , Willer J.C.
Electroacupuncture in the treatment of pain using peripheral electrostimulation. *J Belge Med Phys Rehabil* 1980; 3 (3): 220 - 230
9. Wu G.C., Zhu J., Cao X.
Involvement of opioid peptides of the preoptic area during electroacupuncture analgesia. *Acupunct Electrother Res* 1995; 20 (1): 1 - 6

Spinal pain is an extremely common painful state that can result from a wide variety of anatomical lesions

14. HOW TO USE THE WIRELESS PROFESSIONAL ON SPECIFIC INDICATIONS

and various physiopathological mechanisms.

Whatever the triggering factors, the quasi-systematic occurrence of contracture of the paravertebral muscles is often directly responsible for spinal pain.

The increase in the tension of the contracted muscle fibres and the crushing of the capillary network resulting from this causes a decrease in the blood flow and a gradual accumulation of acid metabolites and free radicals. This muscular "acidosis" is directly responsible for the pain, which in turn sustains and reinforces the degree of contracture. If left untreated, there is a risk that the contracture will become chronic and real atrophy of the capillary network will gradually develop; the aerobic metabolism of the muscle fibres deteriorates, giving way to glycolytic metabolism, which gradually becomes predominant. This mechanism of chronic contracture is summarised in the following diagram:

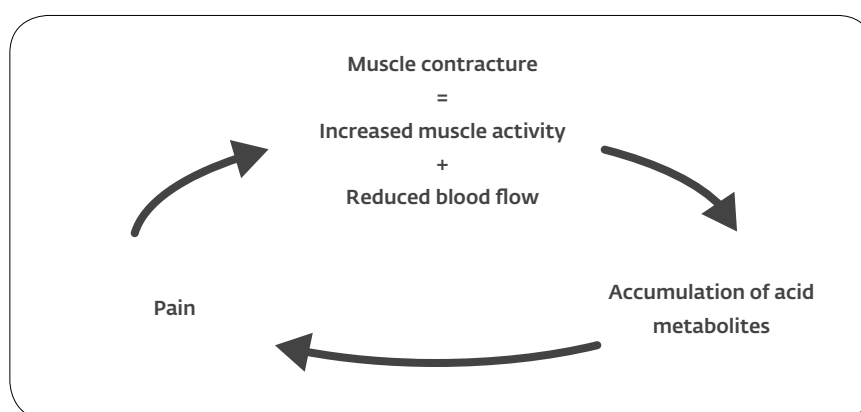

In addition to the general effect of increasing endorphin production (which raises the pain perception threshold), stimulation with an endorphinic programme produces marked local hyperaemia and allows drainage of acid metabolites and free radicals.

The major analgesic effect obtained in this way during each session should not, however, lead to premature termination of treatment. Indeed, in order to restore the atrophic capillary network, the treatment must be continued for a minimum of ten sessions or so.

14. HOW TO USE THE WIRELESS PROFESSIONAL ON SPECIFIC INDICATIONS

14.10.1 Endorphinic treatment of cervical pain

Chronic contractures of the levator scapulae and/or superior trapezius are often responsible for the painful symptoms in patients with neck pain. The use of endorphinic treatment on these contracted muscles is thus the treatment of choice for this condition.

However, it must be ensured that the stimulation energy levels are sufficient to obtain clearly visible muscle twitches (leading to a marked hyperaemic effect) so that the acid metabolites swamping the capillary bed of the contracted muscle can be drained away.

This treatment should be continued for at least ten sessions in order to restore the capillary network, which is usually atrophic in chronically contracted muscles.

14.10.1.1 Protocol

Cervical pain: 10 to 12 weeks

14.10.1.2 Treatment frequency

Three to five sessions per week for two to three weeks (10 to 12 sessions in total).

Each session should last at least 20 minutes. Ideally, it may be beneficial to carry out two successive stimulation sessions with the Neck pain programme, ensuring a ten-minute rest period is taken between the two sessions to allow the stimulated muscles to recover.

14.10.1.3 Electrode position

Depending on the location of the pain (unilateral or bilateral), one or two stimulation channels are used:

- A small electrode is placed on the most painful point that can be found by palpation. In most cases this point of maximum contracture is found in the levator scapulae or superior trapezius.
- In the case of bilateral pain, another small electrode is likewise placed on the most painful point. For optimum effectiveness, the positive pole of each channel should preferably be positioned on the painful area.

One or two small electrodes are placed on the cervical paravertebral muscles at C3 - C4 level.

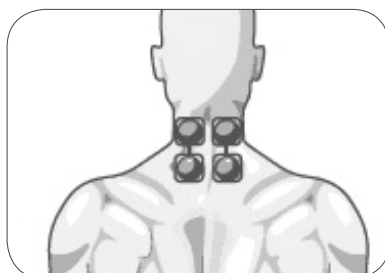

14. HOW TO USE THE WIRELESS PROFESSIONAL ON SPECIFIC INDICATIONS

14.10.1.4 Patient position

The patient is placed in the position most comfortable for him/her: prone position or seated facing a medical table with a chest support.

14.10.1.5 Stimulation energy

The energy must be increased gradually until it causes clearly visible muscle twitches, which are required to induce hyperaemia.

The mi-RANGE function makes it possible to work with certainty within a therapeutically effective range.

The stimulator prompts you to firstly increase the level of energy:

- a beep sound accompanies the flashing "+" symbols.
- When it detects that the muscles have started to pump, the "+" symbols will stop flashing. You are at the minimum level of energy that provides therapeutic results.

If the stimulation is well tolerated by the patient, it is advised to increase the energy level slightly.

At the end of the treatment or during a break, a statistic showing the percentage of time spent in the effective range will appear on the screen.

14. HOW TO USE THE WIRELESS PROFESSIONAL ON SPECIFIC INDICATIONS

14.10.2 Endorphinic treatment of thoracic back pain

Whatever the trigger, chronic contractures of the dorsal paravertebral muscles (erector spinae) are responsible for the pain that incapacitates patients suffering from thoracic back pain.

Provided that sufficient stimulation energy is used to obtain clear muscle twitches, the dorsalgia treatment - thanks to the remarkable hyperaemia it causes - will be particularly effective for draining the metabolic acids that have built up in the contracted muscle.

A significant analgesic effect will therefore usually be observed in the first treatment sessions.

This treatment should however be continued for at least ten sessions in order to restore the capillary network, which is usually atrophied in chronically contracted muscles.

14.10.2.1 Protocol

Thoracic back pain: 10 to 12 sessions.

14.10.2.2 Treatment frequency

Three to five sessions per week for two to three weeks (10 to 12 sessions in total).

A session should last at least 20 minutes. Ideally, it may be beneficial to carry out two successive stimulation sessions within the Thoracic back pain programme, ensuring however a ten-minute rest period between the two sessions to allow the stimulated muscles to recover.

14.10.2.3 Electrode position

The points of maximum contraction are usually bilateral but not always symmetrical; therefore, two stimulation channels are used.

- Two small electrodes are placed on the most painful points, which can be easily located by palpatory examination of the painful area.

For optimum effectiveness, the positive pole should preferably be positioned on the painful area.

- Two other electrodes, also small ones, are placed on the top of the erector spinae muscles, a few centimetres above or below the electrodes placed on the painful points, depending on whether the pain radiates towards the neck or the lumbar region.

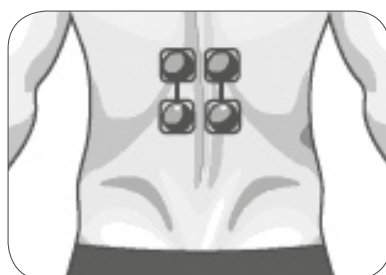

14. HOW TO USE THE WIRELESS PROFESSIONAL ON SPECIFIC INDICATIONS

14.10.2.4 Patient position

The patient is placed in a position he/she finds the most comfortable: in the prone or side lying position, or seated.

14.10.2.5 Stimulation energy

The energy must be increased gradually until it causes clearly visible muscle twitches, which are required to induce hyperaemia.

The mi-RANGE function makes it possible to work with certainty within a therapeutically effective range. The stimulator prompts you to firstly increase the level of energy:

- a beep sound accompanies the flashing "+" symbols.
- When it detects that the muscles have started to pump, the "+" symbols will stop flashing. You are at the minimum level of energy that provides therapeutic results.

If the stimulation is well tolerated by the patient, it is advised to increase the energy level slightly. At the end of the treatment or during a break, a statistic showing the percentage of time spent in the effective range will appear on the screen.

14. HOW TO USE THE WIRELESS PROFESSIONAL ON SPECIFIC INDICATIONS

14.10.3 Endorphinic treatment of low back pain

Chronically contracted lumbar paravertebral muscles are often the source of pain felt by patients with lumbago. Although a physiotherapist must naturally find the cause of the pain and treat it accordingly, treatment of these chronic contractions using the Low back pain programme brings about fast, significant pain relief. In the lumbar region, the stimulation currents required to obtain visible (or at least palpable) muscle twitches are generally high and can be difficult to tolerate by some patients. This is why it is generally recommended to combine TENS treatment with the Low back pain programme to make treatment more comfortable for the patient.

This treatment should be continued for at least ten sessions in order to restore the capillary network, which is usually atrophic in chronically contracted muscles.

14.10.3.1 Protocol

Low back pain + TENS : 10 to 12 sessions

The Low back pain programme is designed to provide endorphinic stimulation on the first two channels and TENS stimulation on the other two channels.

14.10.3.2 Treatment frequency

Three to five sessions per week for two to three weeks (10 to 12 sessions in total), a session should last at least 20 minutes.

Ideally, it may be beneficial to carry out two successive stimulation sessions within the Low back pain programme, ensuring a ten-minute rest period is taken between the two sessions to allow the stimulated muscles to recover.

14. HOW TO USE THE WIRELESS PROFESSIONAL ON SPECIFIC INDICATIONS

14.10.3.3 Electrode position

Three stimulation channels are used.

In the Low back pain programme, endorphinic stimulation is always used on channels 1 and 2, while the TENS stimulation is provided on channels 3 and 4.

For endorphinic treatment:

- Two small electrodes are placed on the most painful points, which can be easily located by palpating the lumbar paravertebral muscles.
For optimum effectiveness, the positive pole should preferably be positioned on the painful area.
- Two large electrodes with two outputs are placed a finger-width outside the small electrodes and are attached to the negative poles of the two previous channels.

For the TENS treatment:

The free outputs of the two large electrodes are used to connect the third channel.



14.10.3.4 Patient position

The patient is placed in the position he/she finds the most comfortable: in the side lying or prone position, taking care to use a cushion or a specially designed table to prevent lordosis.

14. HOW TO USE THE WIRELESS PROFESSIONAL ON SPECIFIC INDICATIONS

14.10.3.5 Stimulation energy

The energy must firstly be adjusted on the third channel (TENS). The energy is gradually increased until the patient feels a strong tingling sensation in the lumbar region.

The energy is then adjusted on channels 1 and 2 (endorphinic).

The energy is gradually increased in order to cause muscle twitches, visible if possibly (or at least palpable).

If the patient finds it hard to tolerate the energy increase, due to the discomfort it can cause, it is recommended to temporarily stop increasing the energy on the first two channels. The energy is then increased again on the third channel (TENS) in order to increase the feeling of paresthesia in the lumbar region.

After a minute or two, the energy can be increased again on the first two stimulation channels so that the muscle twitches can be seen.

It is essential to increase the energy on channels 1 and 2 sufficiently to cause visible (or at least palpable) muscle twitches. In fact, these muscle twitches are directly responsible for the significant hyperaemia effect and therefore guarantee the effectiveness of the treatment.

Note

When TENS is used in combination with an endorphinic programme (such as the Low back pain programme in this case) the mi-TENS function is inactive.

14. HOW TO USE THE WIRELESS PROFESSIONAL ON SPECIFIC INDICATIONS

14.10.4 Treatment of lumbosciatic pain

Patients suffering from lumbosciatic pain most often present lumbar pain that commonly originates from chronic contractures of the lumbar paravertebral muscles.

In addition, involvement of the spinal nerve root leads to irradiation of pain over a shorter or longer distance along the sciatic nerve and in some cases, along one or the other of its branches (common peroneal or tibial).

The combination of the Lumbosciatica programme and the TENS programme is the preferred treatment, as it produces - through its endorphinic effect (Lumbosciatic programme) – a significant analgesic effect on chronic contractures of the lumbar region and – through the TENS programme – reduces the medullar input of the nociceptive impulse (Gate control) due to painful irradiation of the sciatic nerve.

Combining endorphinic stimulation with TENS stimulation is entirely appropriate here as on one hand, it treats low back pain caused by chronic contractures of the muscles in that area, and on the other hand, relieves neurogenic pain of the sciatic nerve, for which TENS is the treatment of choice.

14.10.4.1 Protocol

Lumbosciatica: 10 to 12 sessions.

The Lumbosciatica programme is designed to provide endorphinic stimulation on the first channel and TENS stimulation on the other three channels.

14.10.4.2 Treatment frequency

Three to five sessions per week for two to three weeks (10 to 12 sessions in total), a session should last at least 20 minutes.

Ideally, it may be beneficial to carry out two successive stimulation sessions within the Lumbosciatica programme, ensuring a ten-minute rest period is taken between the two sessions to allow the stimulated muscles to recover.

14. HOW TO USE THE WIRELESS PROFESSIONAL ON SPECIFIC INDICATIONS

14.10.4.3 Electrode position

Two stimulation channels are used, ensuring they are switched on in the correct order, as this determines the order in which the channels deliver stimulation. With the Lumbosciatica programme, the endorphinic stimulation is always provided on channel 1, whereas the TENS stimulation is delivered by channels 2, 3 and 4.

For endorphinic treatment:

- A small electrode is placed on the top of the root of the sciatic nerve, which is painful to palpate. For optimum effectiveness, the positive pole should preferably be positioned on this painful area.
- Another small electrode is placed two finger-widths above the previous electrode and is attached to the negative pole of the same channel

For TENS treatment:

Two large electrodes are placed on the path of the sciatic nerve:

- one on the lower part of the buttock and
- the other on the posterior thigh.
- The second channel is connected to these large, single-output electrodes.

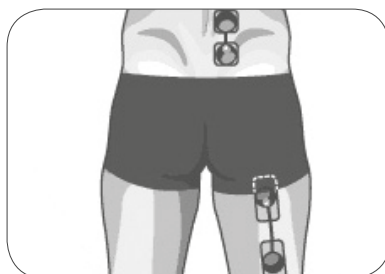

Note

The 3rd and/or 4th channel (TENS) can be used in two situations:

- In the event of more extensive irradiation in the common peroneal or tibial nerves. Two large electrodes are therefore placed longitudinally on the calf (tibial) or laterally (common peroneal) on the lower leg and are connected by a channel.
- If the patient does not like endorphinic stimulation in the lumbar region two large electrodes are placed to the lumbar region and are connected by a channel.

14.10.4.4 Patient position

The patient is placed in the position he/she finds the most comfortable: in the prone position (with a cushion or on a specially designed table to prevent lordosis) or in the side lying position.

14. HOW TO USE THE WIRELESS PROFESSIONAL ON SPECIFIC INDICATIONS

14.10.4.5 Stimulation energy

The energy is gradually increased on the second channel (TENS), in order to cause a distinctive tingling sensation along the painful irradiation of the sciatic nerve.

The gradual energy increase on the first channel must be sufficient to obtain visible (or at least palpable) muscle twitches of the muscles of the lumbar region, which cause hyperaemia.

Note

When TENS is used in combination with an endorphinic programme (such as the Low back pain programme in this case) the mi-TENS function is inactive.

14. HOW TO USE THE WIRELESS PROFESSIONAL ON SPECIFIC INDICATIONS

14.11 Hemiplegia - Spasticity

This chapter examines the treatment of problems specific to the hemiplegic patient, including spasticity, which is found not only in hemiplegic patients but also in most disorders of the central nervous system (tetraplegia, paraplegia, multiple sclerosis, etc.).

The practical methods of treatment described in this chapter are based on the following reference publications:

1. Wal J.B.
Modulation of Spasticity: Prolonged Suppression of a Spinal Reflex by Electrical Stimulation. *Science* 216: 203 - 204, 1982
2. Baker L.L., Yeh C., Wilson D., Waters R.L.
Electrical Stimulation of Wrist and Fingers for Hemiplegic Patients. *Physical Therapy* 59: 1495 - 1499, 1979
3. Alfieri V.
Electrical Treatment of Spasticity. *Scand. J Rehab Med* 14: 177 - 182,
4. Carnstan B., Larsson L., Prevec T.
Improvement of Gait Following Electrical Stimulation. *Scand J Rehab Med* 9: 7 - 13, 1977
5. Waters R., McNeal D., Perry J. Experimental Correction of Foot Drop by Electrical Stimulation of the Peroneal Nerve. *J Bone Joint Surg (Am)* 57: 1047 - 54, 1975
6. Liberson WT, Holmquest HJ, Scot D
Functional Electrotherapy: Stimulation of the Peroneal Nerve Synchronized with the Swing Phase of the Gait Hemiplegic Patient. *Arch Phys Med Rehabil* 42: 101 - 105, 1961
7. Levin MG, Knott M, Kabat H
Relaxation of Spasticity by Electrical Stimulation of Antagonist Muscles. *Arch Phys Med* 33: 668 - 673, 1952

The treatments discussed in this chapter are applicable through the programmes in the Neurological Rehabilitation category and some of these programmes require each contraction to be manually triggered.

All programmes used reduce spasticity as long as they are applied correctly to the muscles antagonistic to the spastic muscles. Some of these programmes are intended solely for the treatment of spasticity, while others are intended to treat situations or complications specific to the hemiplegic patient, namely: functional neuromuscular electrical stimulation of the foot and subluxation of the shoulder.

14. HOW TO USE THE WIRELESS PROFESSIONAL ON SPECIFIC INDICATIONS

14.11.1 Dorsiflexion of the hemiplegic foot

One of the problems in hemiplegic patients is the greater or lesser degree of difficulty that they encounter when raising the foot voluntarily, or even the total inability to do so.

For this reason, the foot drops when walking during heel strike.

Neuromuscular electrical stimulation (NMES) in the area of the flexor muscles of the foot (tibialis anterior, extensors of the toe) allows for dorsiflexion to be achieved.

This NMES is functional (FES) if the dorsiflexion achieved is synchronised with the gait so as to stop the foot from dropping when lifted from the ground.

The aim of FES is to teach the hemiplegic patient to walk again by creating a functional gait pattern that the patient is then able to reproduce more easily.

However, this method of gait rehabilitation using FES is not suitable for all hemiplegic patients. Two types of case must be considered:

1. If the stimulation of the muscles lifting the foot produces a spasm reflex in the muscles of the lower limb, this technique should no longer be used (this phenomenon is rare in hemiplegics but more common in paraplegics).
2. If the spasticity of the soleus muscle is considerable, to the point where satisfactory dorsiflexion cannot be achieved, programmes for the treatment of spasticity in the lower limb must be used initially, before resuming work on the gait with FES when spasticity of the triceps surae has been sufficiently reduced.

14.11.1.1 Protocol

The hemiplegic foot. USE CHANNEL 1 (other channels are inactive for this programme)

14.11.1.2 Treatment frequency

Minimum of three sessions per week, the length of treatment varies greatly depending on progress.

14. HOW TO USE THE WIRELESS PROFESSIONAL ON SPECIFIC INDICATIONS

14.11.1.3 Electrode position

A single channel is sufficient to stimulate the levator muscles of the foot.

A small electrode is placed on the motor point of the tibialis anterior.

For optimum effectiveness, the positive pole should preferably be positioned on the lower electrode, which corresponds to the motor point of the tibialis anterior.

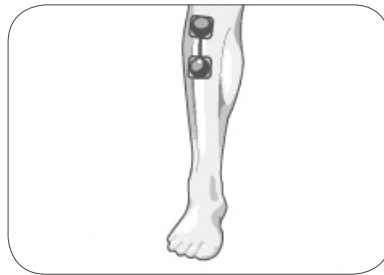

14.11.1.4 Stimulation energy

Use the energy necessary to achieve slight dorsiflexion that is enough to prevent the foot from dropping while walking. In this application, there is nothing to be gained from producing a more powerful contraction that might diffuse into the antagonists.

Activate the contraction by pressing any key on any channel. As this contraction phase is very short, rapidly increase the energy of channel 1 until satisfactory dorsiflexion is achieved.

14. HOW TO USE THE WIRELESS PROFESSIONAL ON SPECIFIC INDICATIONS

14.11.2 Spasticity

Reminder

Spasticity or spastic hypertonia is a term which describes the condition of paretic or paralysed muscles showing different symptoms to varying degrees, including in particular, an increase in muscle tonus mainly in the antigravity muscles, hyperreflexia, and clonus.

During passive stretching of a spastic muscle, there is resistance at the beginning of the movement, which then diminishes in the course of extension.

The more rapid the passive stretching movement, the stronger this resistance.

If passive stretching is very rapid and is maintained, clonus may occur, i.e. a contractile oscillation of 5 to 7 Hz, which persists for 40 to 60 cycles for as long as the stretching is maintained.

Spasticity is caused by a lesion in the central nervous system which affects the tractus pyramidalis (cerebral-spinal tract).

This interruption in central control releases the activity of the myotatic stretch reflex, which becomes hyperactive. As this stretch reflex is responsible for muscular tonus, hypertonia develops affecting mainly the antigravity muscles (extensions of the lower limbs and flexors of the upper limbs), since these contain more neuromuscular spindles than their antagonist muscles.

In time, spasticity leads to the shortening of muscle-tendon structures and a reduction in the range of articular movement, which can lead to stiffening and misalignment of the joints.

Use of neuromuscular electrical stimulation (NMES)

Starting in the neuromuscular bundles are afferent proprioceptive nerve fibres, which are directly associated with the α motor neurons of the same muscle and which are indirectly associated (via interneurons) with the α motor neurons of the antagonist muscle.

Stretching a muscle therefore stimulates the afferent proprioceptive nerve fibres of the neuromuscular bundles and they monosynaptically activate the α motor neurons of the muscle being stretched (myotatic stretch reflex) and inhibit, via an interneuron, the α motor neurons of the antagonist muscle (reciprocal inhibition reflex).

NMES of a muscle excites not only the α motor neurons of that muscle but also, and even more readily, the afferent proprioceptive nerve fibres which are contained in the neuromuscular bundle of the muscle and which have a lower stimulation threshold.

Stimulating these activates the α motor neurons of this muscle and also inhibits the α motor neurons of the antagonist muscle (reciprocal inhibition reflex). It is this last action that NMES uses in the treatment of spasticity: NMES of a muscle antagonist to a spastic muscle makes it possible to reduce the spasticity by inhibiting the α motor neurons of the spastic muscle via the reciprocal inhibition reflex.

This phenomenon of inhibiting α motor neurons through NMES of the antagonist muscle is clearly demonstrated by electromyography.

14. HOW TO USE THE WIRELESS PROFESSIONAL ON SPECIFIC INDICATIONS

In fact, Hoffmann's reflex in a muscle, produced by a stimulus, is reduced in amplitude when the motor nerve of the antagonist muscle is stimulated.

NMES is an effective technique in the treatment of spasticity, not only because it reduces hypertonia, but also because it allows strengthening of the antagonist muscle as well preventive or curative stretching of the retraction of the spastic muscles; this is much more effective than the conventional passive methods.

However, care must be taken in the treatment of spasticity to ensure that NMES is used correctly to achieve a positive effect. It is particularly necessary to avoid stimulating spastic muscle by diffusion, which can occur when the electrical energy is too high. It is also necessary that the antagonist muscle is tensed extremely gradually to avoid over-stretching the spastic muscle and thereby increasing its spasticity. This is achieved through the gradual rate of contraction specific to the Spasticity programme. Another particularity of this programme is the absence of all low frequencies, which can also increase spasticity by generating repeated micro-stretches of the spastic muscle.

Spasticity mainly affects the antigravity muscles of the lower limbs and the flexor muscles of the upper limbs, but out of these muscles, the ones most affected and the severity of spasticity vary greatly depending on the type of disorder of the cerebro-spinal tract (hemiplegia, tetraplegia, paraplegia or multiple sclerosis). Moreover, for the same type of disorder of the cerebro-spinal tract, the severity of spasticity and the muscles in which it is most apparent varies from one patient to another. For these reasons, each case has to be considered individually. It is therefore the task of the therapist to carry out an accurate clinical evaluation of each patient in order to select the muscles on which the treatment is to be concentrated.

In general, spasticity mainly affects the following muscles:

In the lower limbs:

- triceps surae
- quadriceps
- adductors
- gluteus maximus

In the shoulder:

- pectoralis major
- latissimus dorsi

In the upper limbs:

- biceps brachii
- flexors of the fingers and wrist

In the treatment of spasticity, NMES is applied to one or more of the following muscles, depending on the patient: tibialis anterior, extensor of the toes, lateral peroneal, hamstrings, tensor fascia lata, deltoid, supraspinatus, triceps brachii, extensors of the fingers and wrist.

14. HOW TO USE THE WIRELESS PROFESSIONAL ON SPECIFIC INDICATIONS

14.11.2.1 Protocol

Spasticity: length of treatment to be adjusted depending on progress.

If the patient is experiencing associated pain symptoms, TENS stimulation can be performed in addition on the other channels.

In this case, the specific practical rules for TENS (electrode placement, regulation of intensity) should be followed for each channel used for this purpose.

14.11.2.2 Treatment frequency

One or two 20 to 30-minute sessions per day.

14.11.2.3 Electrode position

Place the electrodes on the muscle antagonist to the spastic muscle to be treated. The stimulation does not act on the spastic muscle, but on its antagonist.

14.11.2.4 Patient position

The patient and body part being treated are positioned in such a way as to achieve the maximum range of motion. In fact, unlike the conventional rules for using NMES, it is worthwhile for these treatments to allow for isotonic contraction of the antagonist muscle, causing movement to the maximum range of motion, thus causing maximum stretching of the spastic muscle.

Lower limb:

leg: patient seated

thigh: prone position

Pelvic girdle:

supine position

Shoulder girdle:

patient seated, arm abducted at 30° to the body, elbow resting on an armrest

Upper limb:

patient seated

triceps: elbow in supination;

Extensors of the fingers and wrist: wrist in pronation

14. HOW TO USE THE WIRELESS PROFESSIONAL ON SPECIFIC INDICATIONS

14.11.2.5 Stimulation energy

Always work with an energy that is too low to produce muscle fibre stimulation in the spastic muscles. The stimulation energy must however be adjusted manually so that the isotonic contraction of the antagonist muscle causes movement to the maximum range of motion, thus creating maximum stretch of the spastic muscle.

This action cannot be carried out if the agonist-antagonist imbalance is too great; this occurs when spasticity of a muscle exceeds the contraction strength of its atrophied antagonist. Stimulation then only allows for more or less reduced movement or even no movement at all.

However, the treatment should be carried out even in this situation, because stimulation, even subliminal, has a beneficial effect on the reduction of spasticity.

14.11.2.6 Manual activation of stimulation

When the mi-SCAN is activated, the stimulation session starts automatically with a measurement of the chronaxy. This is a short test lasting around ten seconds, which allows the optimum duration of the stimulation pulse to be adjusted, ensuring maximum comfort. The energy should then be gradually increased to cause the first contraction of the antagonist muscle.

Each contraction is followed by a five-second rest period. Once this rest period has finished, press any button on any channel to trigger the next contraction.

By doing so, each contraction is triggered and therefore controlled by a manual action. This technique provides a clear psychological benefit for the patient, who can trigger contractions with his/her good hand, and it also makes it possible to work synchronously with the associated movements.

14.11.2.7 Associated actions

Passive mobilisation:

When the severity of spasticity causes a marked imbalance between the spastic muscle and its antagonist, and there is a risk of joint stiffness, the therapist can complete the movement induced by stimulation using passive mobilisation or gravity assisted posture

14. HOW TO USE THE WIRELESS PROFESSIONAL ON SPECIFIC INDICATIONS

14.11.3 The hemiplegic hand

In hemiplegic patients, the hand and wrist show paresis or even paralysis with more or less pronounced spasticity of the flexor muscles and atrophy of the extensors. This highly debilitating situation can develop into retraction, stiffening and misalignment if regular treatment is not initiated.

This specific indication is an example of using the Spasticity programme for the area most commonly affected by debilitating spasticity.

14.11.3.1 Protocol

Spasticity

If the patient is experiencing associated pain symptoms, TENS stimulation can be performed in addition on the other channels.

In this case, the specific practical rules for TENS (electrode placement, regulation of intensity) should be followed for each channel used for this purpose.

14.11.3.2 Treatment frequency

One to two 20-minute sessions per day.

14.11.3.3 Electrode position

A single channel is sufficient to stimulate the extensor muscles of the fingers and the wrist.

- A small electrode is placed on the fleshy part of the epicondylar muscles approximately two finger-widths below the epicondyle.
- The second electrode, also small, is placed on the dorsal aspect of the forearm, where the lower and middle thirds meet.

The position of these electrodes must be adjusted so as to firstly obtain extension of the fingers, and then extension of the wrist.

Extension of the wrist alone with flexion of the proximal and distal interphalangeal joints will not produce optimum results.

Extension of the interphalangeal joints is therefore the first objective.

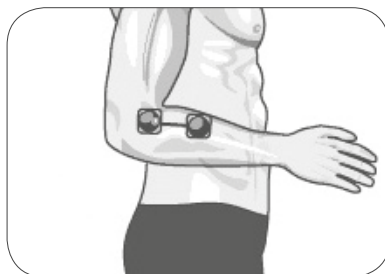

14. HOW TO USE THE WIRELESS PROFESSIONAL ON SPECIFIC INDICATIONS

14.11.3.4 Patient position

The patient is seated beside a table. The elbow and forearm rest on the table, the shoulder is in a functional position, with the elbow bent and the hand in pronation.

14.11.3.5 Stimulation energy

Always work with an energy that is too low to produce diffusion of stimulation to the flexors of the fingers and wrist.

Ideally, the stimulation energy should be adjusted so that the contraction of the extensors extends the fingers and wrist to the maximum range of movement.

The complete movement cannot be carried out if the spasticity of the flexor muscles exceeds the contraction strength of the atrophied extensors. Stimulation will only cause reduced movement, or even no movement at all in extreme cases.

Treatment with NMES should be carried out even in this situation, because even subliminal stimulation has a beneficial effect on the reduction of spasticity.

To complete the extension, passive stretching is also necessary.

Combined treatment of stimulation and passive motion is therefore given.

14.11.3.6 Manual activation of stimulation

When the mi-SCAN is activated, the stimulation session starts automatically with a measurement of the chronaxy. This is a short test lasting around ten seconds, which allows the optimum duration of the stimulation pulse to be adjusted, ensuring maximum comfort. The energy should then be gradually increased to cause the first contraction of the antagonist muscle.

Each contraction is followed by a five-second rest period.

Once this rest period has finished, press any button on any channel to trigger the next contraction.

By doing so, each contraction is triggered and therefore controlled by a manual action. This technique provides a clear psychological benefit for the patient, who can trigger contractions with his/her good hand, and it also makes it possible to work synchronously with the associated movements.

14.11.3.7 Associated actions

Passive mobilisation:

When contraction of the extensors is insufficient to mobilise the fingers and wrist to their maximum range, the movement should be completed by passive extension.

The electrically-induced contraction is allowed to develop until the maximum extension it can produce is achieved.

The movement is then completed by applying gentle and gradual pressure.

14. HOW TO USE THE WIRELESS PROFESSIONAL ON SPECIFIC INDICATIONS

14.11.4 The hemiplegic shoulder

Reminder

One of the specific problems commonly encountered in hemiplegic patients is subluxation of the paretic or paralysed shoulder.

Atrophy with loss of strength which affects the abductor muscles of the arms (deltoid and supraspinatus muscles) results in an inability to provide satisfactory support for the head of the humerus. In addition, more or less pronounced spasticity of the depressor muscles of the shoulder (pectoralis major and latissimus dorsi) causes a downward pull on the head of the humerus, which adds to the pull caused by the weight of the limb.

This situation commonly leads to the displacement of the head of the humerus from the glenoid cavity.

Radiologically, it is clear that the axis of the anatomical neck of the humerus no longer passes through the centre of the glenoid cavity.

This is inferior subluxation.

This subluxated shoulder can often cause pain. The pain can remain localised around the shoulder, but can also radiate into the upper limb towards the hand through stretching of branches of the brachial plexus. Vasomotor and trophic disorders of the hand, such as those seen in algoneurodystrophy (complex regional pain syndrome) may be combined, resulting in classic shoulder-hand syndrome.

Use of neuromuscular electrical stimulation (NMES)

NMES of the abductor muscles of the arm (deltoid and supraspinatus) may be used to prevent or treat atrophy and reduce spasticity in the latissimus dorsi and pectoralis major muscles.

This technique is indicated in the prevent or treatment of subluxation of the shoulder in hemiplegic patients. Radiological investigations show evidence of re-centring of the humeral head in relation to the glenoid cavity.

Moreover, pain in the shoulder and upper limb often associated with subluxation is effectively reduced by this type of treatment. However, in the event of pain radiating in the upper limb, the analgesic action can be supported by using TENS (Gate control), which is programmed on the third and fourth channel.

In shoulder-hand syndrome, in addition to shoulder pain, which is itself a secondary problem associated with hemiplegia, complex regional pain syndrome (CRPS) can occur, which affects the hand. In this situation, CRPS should be treated using the programmes and method described in this chapter, which deal with this disorder (algoneurodystrophy).

14.11.4.1 Protocol

The hemiplegic shoulder

14. HOW TO USE THE WIRELESS PROFESSIONAL ON SPECIFIC INDICATIONS

14.11.4.2 Treatment frequency

One 25-minute session per day, five days per week, for 4 weeks.

Regular treatment carried out in one single session per week may then be necessary in the absence of significant recovery or the persistence of considerable spasticity of the pectoralis major muscle.

14.11.4.3 Electrode position

Two channels are used to stimulate the abductor muscles of the arm.

One channel for the deltoid and the other for the supraspinatus.

- A small electrode is placed on the lateral aspect of the shoulder, in the middle of the deltoid muscle;
- another small electrode is placed on the outer part of the supraspinatous fossa.

For optimum effectiveness, the positive pole should preferably be positioned on the small electrodes which correspond to motor points. The negatives poles are connected to the two outputs of a large electrode placed on the acromion like an epaulette.

If there is painful irradiation towards the hand and forearm, TENS stimulation is available on channels 3 and 4.

For TENS, two large electrodes are used for each channel, positioned to cover or follow the painful area or irradiation.

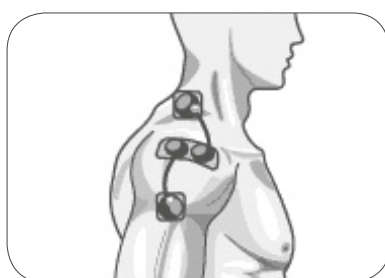

14.11.4.4 Patient position

The patient is seated beside a table, with his/her elbow and forearm resting on a cushion on the table.

14. HOW TO USE THE WIRELESS PROFESSIONAL ON SPECIFIC INDICATIONS

14.11.4.5 Stimulation energy

The energy is gradually increased for each contraction until the maximum tolerable energy level is reached. The therapist plays a fundamental role in encouraging and reassuring the patient, who can then tolerate levels of energy that produce powerful contractions.

If the TENS programme is used on channels 3 and 4, the energy will be adjusted on these channels so that the patient clearly feels moving tingling.

However, care must be taken to ensure that the energy is low enough to avoid any muscle contraction.

14. HOW TO USE THE WIRELESS PROFESSIONAL ON SPECIFIC INDICATIONS

14.12 Treatment of venous insufficiency

Unlike occasionally experiencing heavy legs, venous insufficiency is a result of organic damage to the vein walls which clinically manifests as large or small varicose veins. These are the result of a permanent dilation, secondary to the hyperpressure and stasis of the venous blood, to which is added progressive hypoxia of the intima (inner layer of the wall).

The deficiency of the valves of the deep veins and the perforating veins is behind this process. Their role in preventing the regurgitation of venous blood is no longer guaranteed. Hydrostatic pressure is accentuated and muscle contractions are no longer sufficient to evacuate the venous blood.

The blood stagnates and causes hyperpressure in the superficial veins until varicose distensions are produced.

Stasis oedema is often associated with venous insufficiency, but not always. Moreover, this oedema may be present or absent in the same patient, depending on the time of day and how much time the patient has spent standing up.

We must therefore distinguish between:

- e. Venous insufficiency without oedema.
- f. Venous insufficiency with oedema.

The implications for the type of the electrostimulation programme are different depending on whether there is or is not an oedema associated with varicose veins.

The electrode placements for these programs are proposed with 4 stimulation channels (WIRELESS PROFESSIONAL 4CH devices)

14.12.1 Venous insufficiency without oedema

On one hand, electrical stimulation must allow for an increase in the general blood flow (arterial as well as venous) so as to improve the circulation of the interstitial fluid and increase oxygenation of the tissues and the intima of the veins. On the other hand, it is necessary to drain the veins as much as possible to combat stasis. The increase in arterial flow (and therefore capillary flow, and therefore venous flow) is achieved by means of the optimum low frequency for increase of flow, i.e. 8 Hz.

The deep veins are drained by being compressed, which is caused by tetanic contractions of the leg muscles. The programme therefore consists of short tetanic contractions of the leg muscles, separated by long active pauses to increase the flow.

14.12.1.1 Protocol

Venous insufficiency 1

14. HOW TO USE THE WIRELESS PROFESSIONAL ON SPECIFIC INDICATIONS

14.12.1.2 Treatment frequency

3 to 6 sessions per week for approximately 6 weeks to treat the acute episode. It is then recommended to keep up treatment with a few weekly sessions.

14.12.1.3 Electrode position

Two channels are required for each leg.

- A small electrode is placed just under the head of the fibula on the common peroneal nerve, and
- another small electrode in the upper part of the popliteal fossa over the tibial nerve.
For optimum effectiveness, the positive poles should preferably be positioned on these two small electrodes.
- The two other negative poles are connected to the two outputs of a large electrode placed on the upper part of the calf, just below the popliteal fossa.



14.12.1.4 Patient position

The patient must be in a supine position with his/her legs inclined so that gravity encourages venous return.

14.12.1.5 Stimulation energy

For the draining stage (contraction): the energy must be gradually increased until a significant and balanced contraction is being caused for all stimulated muscles.

For the activation stage of blood circulation: the energy must be increased until clearly visible muscle twitches are obtained.

14. HOW TO USE THE WIRELESS PROFESSIONAL ON SPECIFIC INDICATIONS

14.12.2 Venous insufficiency with oedema

The presence of oedema, particularly when it does not go upon wakening, completely changes the electrical stimulation programme.

Oedema is caused by blood plasma leaking through the venous membranes, due to hyperpressure in the distal veins. In this case, it is not possible to use the low arterial flow increase frequencies because they reduce peripheral vascular resistance, increase the perfusion pressure of the capillaries and risk aggravating the oedema.

On the other hand, tetanic contractions encourage drainage of the deep veins and drainage of the oedema, provided they are carried out in a certain order and under certain conditions.

The most effective way consists of producing an initial ejection effect in the leg and then in the thigh, without relaxing the compression of the deep veins in the leg.

In this way, the venous blood is pushed in the first stage towards the thigh by a contraction of the leg muscles.

Then, in the second stage, the contraction of the thigh muscles eject the blood upwards, provided however that the leg muscles remain contracted to prevent regurgitation.

14.12.2.1 Protocol

Venous insufficiency 2

14.12.2.2 Treatment frequency

3 to 6 sessions per week for approximately 6 weeks to treat the acute episode.

It is then recommended to keep up treatment with a few weekly sessions.

14.12.2.3 Electrode position

It is necessary to work in staggered contractions mode.

This means that only channels 1 and 2 start to produce a tetanic contraction, while channels 3 and 4 are at rest.

After 3 seconds of tetanic contraction via channels 1 and 2, the contraction starts only on channels 3 and 4, while the contraction induced by channels 1 and 2 continues.

After 3 seconds of simultaneous contraction on the four channels, there is a complete rest phase of 20 seconds on the four channels.

14. HOW TO USE THE WIRELESS PROFESSIONAL ON SPECIFIC INDICATIONS

For this program, it is therefore particularly important to follow the order of channel numbers below:

For the calf (channels 1 and 2):

- A small electrode is placed just under the head of the fibula on the common peroneal nerve, and
- another small electrode in the upper part of the popliteal fossa over the tibial nerve.

For optimum effectiveness, the positive pole should preferably be positioned on these two small electrodes.

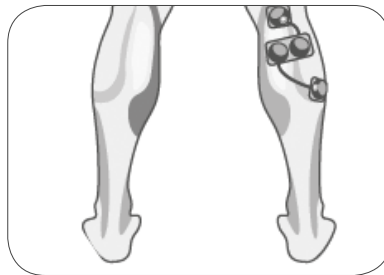

For the thigh (channels 3 and 4):

For the quadriceps (channel 3):

- a large electrode is placed diagonally on the lower third of the quadriceps,
- a second large electrode is placed at the top of the thigh.

For optimum effectiveness, the positive pole should preferably be positioned on the large lower electrode.

For the hamstrings (channel 4):

- a large electrode is placed diagonally on the lower third of the hamstrings,
- a second large electrode is placed diagonally on the upper third of these muscles. For optimum effectiveness, the positive pole should preferably be positioned on the large lower electrode.

14. HOW TO USE THE WIRELESS PROFESSIONAL ON SPECIFIC INDICATIONS

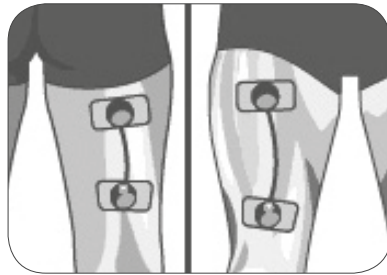

The two other negative poles are connected to the two outputs of a large electrode placed on the upper part of the calf, just below the popliteal fossa.

14.12.2.4 Patient position

The patient must be in a supine position with his/her legs inclined so that gravity encourages venous return.

14.12.2.5 Stimulation energy

Adjust the stimulation energy to obtain significant contractions for the 4 channels and if possible, at a higher level on channels 1 and 2 than on channels 3 and 4.

14. HOW TO USE THE WIRELESS PROFESSIONAL ON SPECIFIC INDICATIONS

14.13 Treatment of arterial insufficiency in the lower limbs

We will limit this chapter to insufficiency of the arteries in the lower limbs.

High blood pressure, smoking, cholesterol and diabetes are among the main causes of progressive deterioration of the arterial walls (arteriosclerosis).

This presents as narrowing of the arteries with, consequently, a reduction in the blood flow in the tissues downstream of the narrowed arteries.

The less well irrigated tissues suffer and become hypoxic, all the more so because the width of the arteries has shrunk and more intense activity requires more oxygen.

Arterial insufficiency in the lower limbs is conventionally divided into four clinical stages. These four stages (I, II, III, and IV) depend on the approximate severity of the loss of blood flow and the tissue-related consequences.

Stage I is asymptomatic. In a clinical examination, an arterial murmur can be heard, which is evidence of narrowing, although the patient has no complaint.

In **Stage II**, the reduction in the flow causes pain in the legs when walking. At rest, the flow is sufficient, but it cannot meet tissue requirements during physical activity: the patient suffers from "intermittent claudication" (IC).

This means that pain occurs after walking a certain distance (the shorter the distance, the more severe the condition); in the end, this pain makes the patient stop: then, after a recovery period, the pain lessens and the person can resume walking until the cycle starts again.

Stage III is characterised by constant pain, including when at rest. Blood flow is so reduced that the tissues constantly suffer from hypoxia with a continual presence of acid metabolites.

Stage IV corresponds to suffering that is so advanced that tissue necrosis with gangrene occurs. This is then called critical ischaemia, a condition which often leads to amputation.

Only Stages II and III can benefit from treatment by electrostimulation.

Stage IV is an emergency situation and requires surgical treatment.

Stage I is asymptomatic and the patient has no complaint.

14. HOW TO USE THE WIRELESS PROFESSIONAL ON SPECIFIC INDICATIONS

14.13.1 Stage II arterial insufficiency

With intermittent claudication (Stage II), the muscle fibres suffer from an oxygen shortage during physical activity.

The narrowed arteries cannot meet the fibres' need for oxygen, which increases with walking.

With a chronic reduction in blood flow and a lack of oxygen, the capillary network degenerates and the fibres lose their oxidative power.

They use the little oxygen that they still receive increasingly badly.

Therefore, the problem becomes twofold: very little oxygen provided and poor use of what oxygen there is. Low frequency stimulation can act on the fibres' capacity to use oxygen.

Considerable studies have shown that low frequency stimulation leads to an improvement in the oxidative capacity of the stimulated muscle (increase in the number and size of mitochondria, increase in oxidative enzymatic activity). Electrostimulation therefore improves the tolerance of muscle fibres to physical activity in the case of arterial insufficiency and thus increases the walking range of patients suffering from intermittent claudication.

14.13.1.1 Protocol

Arterial insufficiency 1

14.13.1.2 Treatment frequency

5 sessions per week for 12 weeks to treat the acute episode.

It is then recommended to keep up treatment with a few weekly sessions.

14. HOW TO USE THE WIRELESS PROFESSIONAL ON SPECIFIC INDICATIONS

14.13.1.3 Electrode position

Two stimulation channels are required for each leg.

- A small electrode is placed just under the head of the fibula on the common peroneal nerve, and
- another small electrode in the upper part of the popliteal fossa at the nerve trunk of the tibial nerve. For optimum effectiveness, the positive pole should preferably be positioned on these two small electrodes.
- The two other negative poles are connected to the two outputs of a large electrode placed on the upper part of the calf, just below the popliteal fossa.

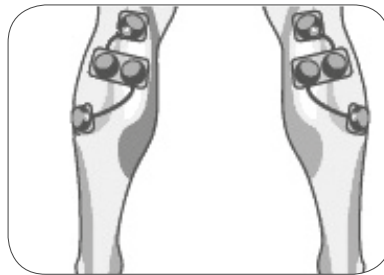

14.13.1.4 Patient position

Place the patient in a comfortable position.

14.13.1.5 Stimulation energy

Adjust the stimulation energy to the maximum level the patient can tolerate, to recruit as many fibres as possible.

14. HOW TO USE THE WIRELESS PROFESSIONAL ON SPECIFIC INDICATIONS

14.13.2 Stage III arterial insufficiency

The same benefit can be obtained using low frequency electrostimulation in Stage III arterial insufficiency. In this case, because of the more severe obstruction of the arterial width and the more serious deterioration of the muscle qualities, stimulation frequencies lower than those used for intermittent claudication must be used.

To carry out a Stage III arterial insufficiency session, we will proceed in the same way as in stage II, but using a programme adapted to more severe deterioration of the arterial capital.

14.13.2.1 Protocol

Arterial insufficiency 2

The protocol is absolutely identical, apart from the patient position.

14.13.2.2 Patient position

The difficulty with which the arterial blood is transported to the distal extremities makes it preferable to position the patient in such a way that gravity aids the arterial circulation.

The patient is therefore placed on a comfortable seat in such a way that does not compress the posterior arterial trunks.

DJO GLOBAL

AUSTRALIA:

T: +1300 66 77 30
F: +1300 66 77 40
E: customerservice.au@DJOglobal.com

BENELUX:

T: Belgium 0800 18 246
T: Netherlands 0800 0229442
T: Luxembourg 8002 27 42
E: benelux.orders@DJOglobal.com

CANADA:

T: +1 866 866 5031
F: +1 866 866 5032
E: canada.orders@DJOglobal.com

CHINA:

T: (8621) 6031 9989
F: (8621) 6031 9709
E: information_china@DJOglobal.com

DENMARK, FINLAND, NORWAY & SWEDEN:

T: Denmark 89 88 48 57
T: Finland +46 40 39 40 00
T: Norway 23 96 09 27
T: Sweden 040 39 40 00
E: info.nordic@DJOglobal.com

FRANCE:

T: +33 (0)5 59 52 80 88
F: +33 (0)5 59 52 62 99
E: physio@DJOglobal.com

GERMANY:

T: +49 761 4566 01
F: +49 761 456655 01
E: infoservice@DJOglobal.com

ITALY:

T: +39 02 484 63386
F: +39 02 484 09217
E: vendite@DJOglobal.com

INDIA:

T: +91 44 6693 6882
E: customercare.india@DJOglobal.com

SOUTH AFRICA:

T: +27 (0) 87 3102480
F: +27 (0) 86 6098891
E: info.southafrica@DJOglobal.com

SPAIN:

T: +34 934 803 202
F: +34 934 733 667
E: ventas@DJOglobal.com

SWITZERLAND:

T: +41 (0) 21 695 2360
F: +41 (0) 21 695 2361
E: info@compex.ch

UK & IRELAND:

T: +44 (0)1483 459 659
F: +44 (0)1483 459 470
E: ukorders@DJOglobal.com

UNITED STATES:

T: +1 800 336 6569
F: +1 800 936 6569
E: customercare@DJOglobal.com

DJO GLOBAL, EXPORT CENTRES

ASIA-PACIFIC:

DJO Asia-Pacific Limited
Unit 1905, 19/F, Tower II
Grand Central Plaza
138 Shatin Rural Committee Road
Shatin
HONG KONG
T: +852 3105 2237
F: +852 3105 1444
E: info.asia@DJOglobal.com

EUROPE, MIDDLE EAST & AFRICA:

DJO Benelux
Welvaartstraat 8
2200 Herentals
BELGIUM
T: +32 (0) 14248350
F: +32 (0) 14248358
E: info.emea@DJOglobal.com

LATIN AMERICA:

DJO Global, Inc
1430 Decision Street
Vista
CA 92081-8553
U.S.A.
T: 1 800 336 6569
F: 1 800 936 6569
E: info.latam@DJOglobal.com

