

TIG Series

TIG 400 Pulse (JT-400P)

Operator Manual



Intertek

CE

UK
CA



Your new product

Thank you for selecting this Jasic product.

This product manual has been designed to ensure that you get the most from your new product. Please ensure that you are fully conversant with the information provided paying particular attention to the safety precautions. The information will help protect yourself and others against the potential hazards that you may come across.

Please ensure that you carry out daily and periodic maintenance checks to ensure years of reliable and trouble free operation.

Please call your Jasic distributor in the unlikely event of a problem occurring.
Please record below the details from your product as these will be required for warranty purposes and to ensure you get the correct information should you require assistance or spare parts.

Date purchased _____

From where _____

Serial number _____

(The serial number is normally located on the top or underside of the machine and will begin with AA)

For further information on your Jasic product warranty registration please visit:

www.jasic-warranty.co.uk

Disclaimer

Whilst every effort has been made to ensure that the information contained within this manual is complete and accurate, no liability can be accepted for any errors or omissions.

Please note:

Products are subject to continual development and may be subject to change without notice.

Regularly check our product pages at www.Jasic.co.uk for revision updated operating manuals.

No part of this manual may be copied or reproduced by any means without the written permission of Wilkinson Star Limited.

CONTENTS

Index	Page
Your New Product	2
Index	3
Safety Instruction	4
General electrical safety	4
General operating safety	4
PPE	5
Welding processes lens shade selector guide	5
Fume and welding gases	6
Fire risks	6
The working environment	7
Protection from moving parts	7
Magnetic fields	7
Compressed gas cylinders and regulators	7
RF declaration	8
LF declaration	8
Materials and their disposal	8
Product Overview	9
Technical Specifications	10
Description of Controls	11
Functions	13
Installation	16
Operation MMA	18
Operation TIG	20
Remote Control Socket	27
Guide to MMA Welding	28
MMA Welding Problems	32
Guide to TIG Welding	33
TIG Welding Torch	39
TIG Welding Problems	40
Maintenance	42
Error Codes	43
Service Schedule Record	43
Troubleshooting	44
WEEE Disposal	45
RoHS Compliance Declaration	45
UKCA Declaration of Conformity	45
EC Declaration of Conformity	46
Statement of Warranty	47
Options and Accessories	48
Notes	49
Jasic Contact Details	50

SAFETY INSTRUCTION

These general safety norms cover both arc welding machines and plasma cutting machines unless otherwise noted.

It is important that users of this equipment protect yourselves and others from harm or even death. The equipment must only be used for the purpose it was designed for. Using it in any other way could result in damage or injury and in breach of the safety rules.

Only suitably trained and competent persons should use the equipment.

Pacemaker wearers should consult your doctor prior to using this equipment.

PPE and workplace safety equipment must be compatible for the application of work involved.

Always carry out a risk assessment before undertaking any welding or cutting activity

General electrical safety



The equipment should be installed by a qualified person and in accordance with current standards in accordance with current standards in operation. It is the users responsibility to ensure that the equipment is connected to a suitable power supply. Consult with your utility supplier if required. Do not use the equipment with the covers removed.

Do not touch live electrical parts or parts which are electrically charged.

Turn off all equipment when not in use.

In the case of abnormal behaviour of the equipment, the equipment should be checked by a suitably qualified service engineer.

If earth bonding of the work piece is required, bond it directly with a separate cable with a current carrying capacity capable of carrying the maximum capacity of the machine current.

Cables (both primary supply and welding) should be regularly checked for damage and overheating.

Never use worn, damaged, under sized or poorly jointed cables.

Insulate yourself from work and earth using dry insulating mats or covers big enough to prevent any physical contact.

Never touch the electrode if you are in contact with the work piece return.

Do not wrap cables over your body.

Ensure that you take additional safety precautions when you are welding in electrically hazardous conditions such as damp environments, wearing wet clothing and metal structures.

Try to avoid welding in cramped or restricted positions.

Ensure that the equipment is well maintained. Repair or replace damaged or defective parts immediately.

Carry out any regular maintenance in accordance with the manufacturers instructions.

The EMC classification of this product is class A in accordance with electromagnetic compatibility standards CISPR 11 and IEC 60974-10 and therefore the product is designed to be used in industrial environment only.

WARNING: This class A equipment is not intended for use in residential locations where the electrical power is provided by a public low-voltage supply system. In those locations it may be difficult to ensure the electromagnetic compatibility due to conducted and radiated disturbances.

General operating safety

Never carry the equipment or suspend it by the carrying strap or handles during welding.

Never pull or lift the machine by the welding torch or other cables. Always use the correct lift points or handles. Always use the transport under gear as recommended by the manufacturer.

Never lift a machine with the gas cylinder mounted on it.

If the operating environment is classified as dangerous, only use S-marked welding equipment with a safe idle voltage level. Such environments may be for example: humid, hot or restricted accessibility spaces.

SAFETY INSTRUCTION

Use of Personal Protective Equipment (PPE)

Welding arc rays from all welding processes produce intense, visible and invisible (ultraviolet and infrared) rays that can burn eyes and skin.

- Wear an approved welding helmet fitted with an appropriate shade of filter lens to protect your face and eyes when welding or watching.
- Wear approved safety glasses with side shields under your helmet.
- Never use broken or faulty welding helmets.
- Always ensure there are adequate protective screens or barriers to protect others from flash, glare and sparks from the welding area.
- Ensure that there are adequate warnings that welding or cutting is taking place.
- Wear suitable protective flame resistant clothing, gloves and footwear.
- Check and be sure the area is safe and clear of inflammable material before carrying out any welding.

Some welding and cutting operations may produce noise. Wear safety ear protection to protect your hearing if the ambient noise level exceeds the local allowable limit (e.g: 85 dB).



Welding and Cutting Lens Shade Selector Guide

CURRENT	MMA ELECTRODES	MIG LIGHT ALLOYS	MIG HEAVY METALS	MAG	TIG ON ALL METALS	PLASMA CUTTING	PLASMA WELDING	GOUGING ARC/AIR
10	8							
15								
20	9	10	10	10	10			
30								
40	10					11	11	10
60								
80	11	11	11	12	11			
100								
125	12	12	12	13	12		13	11
150								
175	13	13						12
200								
225	14	14	13	14	13	12	14	13
250								
275	15	15	14	15	14			14
300								
350	13	14	13	14	14	13	14	13
400								
450	14	15	14	15				14
500								

SAFETY INSTRUCTION

Safety against fumes and welding gases



Warning
Fumes and
Gases

The HSE have identified welders as being an 'at risk' group for occupational diseases arising from exposure to dusts, gases, vapours and welding fumes. The main identified health effects are pneumonia, asthma, chronic obstructive pulmonary disease (COPD), lung and kidney cancer, metal fume fever (MFF) and lung function changes.

During welding and hot cutting 'hot work' operations, fumes are produced which are collectively known as welding fume. Depending upon the type of welding process being performed, the resultant fume generated is a complex and highly variable mixture of gases and particulates.

Regardless of the length of welding being carried out, all welding fume, including mild steel welding requires suitable engineering controls to be in place which is usually Local Exhaust Ventilation (LEV) extraction to reduce the exposure to welding fume indoors and where LEV does not adequately control exposure it should also be enhanced by using suitable respiratory protective equipment (RPE) to assist with protecting against residual fume.

When welding outdoors appropriate RPE should be used.

Prior to undertaking any welding tasks an appropriate risk assessment should be carried out to ensure expected control measures are in place.

Locate the equipment in a well-ventilated position and keep your head out of the welding fume.

Do not breathe the welding fume.

Ensure the welding zone is well-ventilated and provision should be made for suitable local fume extraction system to be in place.

If ventilation is poor, wear an approved airfed welding helmet or respirator.

Read and understand the Material Safety Data Sheets (MSDS's) and the manufacturer's instructions for metals, consumable, coatings, cleaners and de-greasers.

Do not weld in locations near any de-greasing, cleaning or spraying operations.

Be aware that heat and rays of the arc can react with vapours to form highly toxic and irritating gases.

For further information please refer to the HSE website www.hse.gov.uk for related documentation.

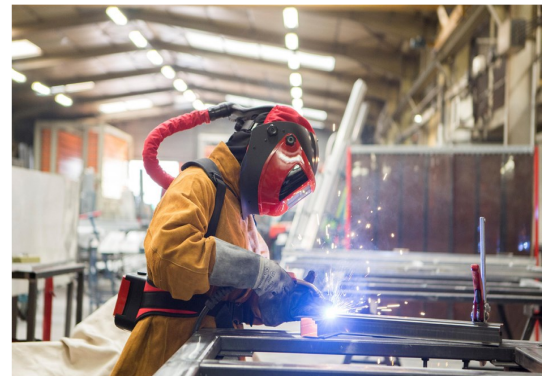

An example of personal fume protection

Precautions against fire and explosion



Warning
Fire Risk

Avoid causing fires due to sparks and hot waste or molten metal.

Ensure that appropriate fire safety devices are available near the welding and cutting area.

Remove all flammable and combustible materials from the welding, cutting and surrounding areas.

Do not weld or cut fuel and lubricant containers, even if empty. These must be carefully cleaned before they can be welded or cut.

Always allow the welded or cut material to cool before touching it or placing it in contact with combustible or flammable material.

Do not work in atmospheres with high concentrations of combustible fumes, flammable gases and dust. Always check the work area half an hour after cutting to make sure that no fires have begun.

Take care to avoid accidental contact of electrode to metal objects. This could cause arcs, explosion, overheating or fire.



Understand your fire extinguishers

SAFETY INSTRUCTION

The Working environment

Ensure the machine is mounted in a safe and stable position allowing for cooling air circulation.

Do not operate equipment in an environment outside the laid down operating parameters.

The welding power source is not suitable for use in rain or snow.

Always store the machine in a clean, dry space.

Ensure the equipment is kept clean from dust build up.

Always use the machine in an upright position.

Protection from moving parts

When the machine is in operation keep away from moving parts such as motors and fans.

Moving parts, such as the fan, may cut fingers and hands and snag garments.

Protections and coverings may be removed for maintenance and controls only by qualified personnel after first disconnecting the power supply cable.

Replace the coverings and protections and close all doors when the intervention is finished and before starting the equipment.

Take care to avoid getting fingers trapped when loading and feeding wire during set up and operation.

When feeding wire be careful to avoid pointing it at other people or towards your body.

Always ensure machine covers and protective devices are in operation.

Risks due to magnetic fields



The magnetic fields created by high currents may affect the operation of pacemakers or electronically controlled medical equipment.

Wearers of vital electronic equipment should consult their physician before beginning any arc welding, cutting, gouging or spot welding operations.

Do not go near welding equipment with any sensitive electronic equipment as the magnetic fields may cause damage.

Keep the torch cable and work return cable as close to each other as possible throughout their length.

This can help minimise your exposure to harmful magnetic fields.

Do not wrap the cables around the body.

Handling of compressed gas cylinders and regulators

Mishandling gas cylinders can lead to rupture and the release of high pressure gas.

Always check the gas cylinder is the correct type for the welding to be carried out.

Always store and use cylinders in an upright and secure position.

All cylinders and pressure regulators used in welding operations should be handled with care.

Never allow the electrode, electrode holder or any other electrically “hot” parts to touch a cylinder.

Keep your head and face away from the cylinder valve outlet when opening the cylinder valve.

Always secure the cylinder safely and never move with regulator and hoses connected.

Use a suitable trolley for moving cylinders.

Regularly check all connections and joints for leaks.

Full and empty cylinders should be stored separately.

Never deface or alter any cylinder

SAFETY INSTRUCTION

RF Declaration

Equipment that complies with directive 2014/30/EU concerning electromagnetic compatibility (EMC) and the technical requirements of EN60974-10 is designed for use in industrial buildings and not those for domestic use where electricity is provided via the low voltage public distribution system. Difficulties may arise in assuring class A electromagnetic compatibility for systems installed in domestic locations due to conducted and radiated emissions. In the case of electromagnetic problems, it is the responsibility of the user to resolve the situation. It may be necessary to shield the equipment and fit suitable filters on the mains supply.

LF Declaration

Consult the data plate on the equipment for the power supply requirements. Due to the elevated absorbance of the primary current from the power supply network, high power systems affect the quality of power provided by the network. Consequently, connection restrictions or maximum impedance requirements permitted by the network at the public network connection point must be applied to these systems. In this case, the installer or the user is responsible for ensuring the equipment can be connected, consulting the electricity provider if necessary.

Materials and their disposal

Welding equipment is manufactured with BSI published standards meeting CE requirements materials which do not contain any toxic or poisonous materials dangerous to the operator. Do not dispose of the equipment with normal waste. The European Directive 2012/19/EU on Waste Electrical and Electronic Equipment states the electrical equipment that has reached its end of life must be collected separately and returned to an environmentally compatible recycling facility for disposal.

For more detailed information please refer to the HSE website www.hse.gov.uk

PRODUCT OVERVIEW

The Jasic TIG inverter range of welding machines have been designed as integrated and portable welding power supply units incorporating the most advanced IGBT inverter technology in power electronics with easy operation and adjustment due to friendly user interface.

Unique electric structure and air channel design in this series of machines can speed up the heat dissipation of the power device as well as improving the duty cycles of the machines. The unique heat rejection efficiency of the air channel can effectively prevent the power devices and control circuits from being damaged by the dust absorbed by the fan and thereby, the reliability of the machine is greatly improved.

The front panel and the rear panel of the machine and the handle are coated with rubber oil, so the machine has soft texture, good hand feeling that feels warm and comfortable to hold.

Jasic TIG 400P Product Features:

- Modern, user friendly control panel, modular design with trolley and water cooler included
- Both DC TIG with pulse and DC MMA are available for excellent weld characteristics
- MMA with VRD function, suitable for a wide range of electrodes in MMA
- 2T/4T latch and spot time facility
- DC TIG pulse with adjustable frequency
- Advanced IGBT inverter technology
- 40Khz inverter frequency, high efficiency
- Adjustable upslope, downslope, pre and post flow gas function
- 8 weld programmable storage channels
- Auto compensation for mains voltage fluctuation
- On demand fan and water cooling
- Front panel remote control sockets
- Built in hot start arc ignition function which ensures excellent arc ignition in MMA for easier and more reliable arc starting
- Built in adjustable arc force technology which maintains the optimum MMA arc conditions during welding even with long cables
- Easy arc starting, low spatter and stable current which offers good weld bead shape
- Generator friendly
- High quality tactile finish to mouldings and handle
- Water cooled package supplied with inverter power source, trolley, water cooler, 12' Titanium 18 TIG torch, gas regulator, work return lead and clamp, operating instructions
- Air cooled package supplied with inverter power source, 12' WP26 TIG torch, gas regulator, work return lead and clamp, operating instructions



Please note:

The Jasic TIG JT-400PA air cooled power source cannot be upgraded to be used with the water cooler.

TECHNICAL SPECIFICATIONS

Parameters		Unit	TIG 400P
Input	Rated input power supply	V	Three phase AC400V 50/60Hz
	Rated input current I _{max}	A	26
	Rated input current I _{eff}	A	14
	Rated input capacity	kVA	17.9
	Power factor	cosφ	0.96
MMA output	Rated no-load voltage	V	68 (15V with VRD on)
	Rated maximum output	A/V	400/36
	Welding current range	A	30 - 400
	Arc force current range	A	0 - 200
	Arc ignition current range	A	0 - 200
	Output characteristic	-	CC
TIG output	Rated maximum output	A/V	400/26
	Welding current range	A	5 - 400
	Pre flow time range	S	0 - 15
	Initial current range	A	5 - 400
	Pilot arc current range	A	5 - 400
	Upslope time range	S	0 - 10
	Base current range	A	5 - 400
	Peak current range	A	5 - 400
	Downslope time range	S	0 - 10
	Post flow time range	S	0 - 15
	Pulse frequency range	Hz	0.5 - 200
	Pulse duration ratio range	%	10 - 90
	Spot welding time	S	0.1 - 10
	Arc ignition mode	-	HF/Lift arc ignition
	Output characteristic	-	CC
Environment	Working temperature range	°C	-10 - +40
	Storage temperature range	°C	-25 - +55
	Humidity	-	≤90% (no water condensate)
Structure	Remote control option	-	Yes
	Enclosure ingress protection	-	IP21S
	Cooling mode	-	Forced air cooling
	Rated duty cycle	%	MMA:30 TIG:50 (40°C)
	Efficiency	%	87
	Idle State Power	W	< 50
	Insulation grade	-	F
	Overall size (L x W x H)	mm	595 x 297 x 528
	Weight	Kg	90

Please Note

Due to variations in manufactured products all claimed performance ratings, capacities, measurements, dimensions and weights quoted are approximate only. Achievable performance and ratings when in use can depend upon correct installation, applications and use along with regular maintenance and service.

CONTROLS

Front view Jasic TIG 400P

1. Digital display weld parameters and protection indication display area
2. Welding mode selection area
3. Weld parameter selection switch
4. Torch trigger selection
5. Water cooler switch
6. HF selection switch
7. "+" Output terminal
8. Control socket for the TIG torch switch and remote control devices i.e. foot pedal
9. N/A
10. Welding gas connection outlet
11. "-" Output terminal
12. MMA parameters
13. VRD indicator
14. Parameter adjustment dial
15. Channel (memory) selection switch

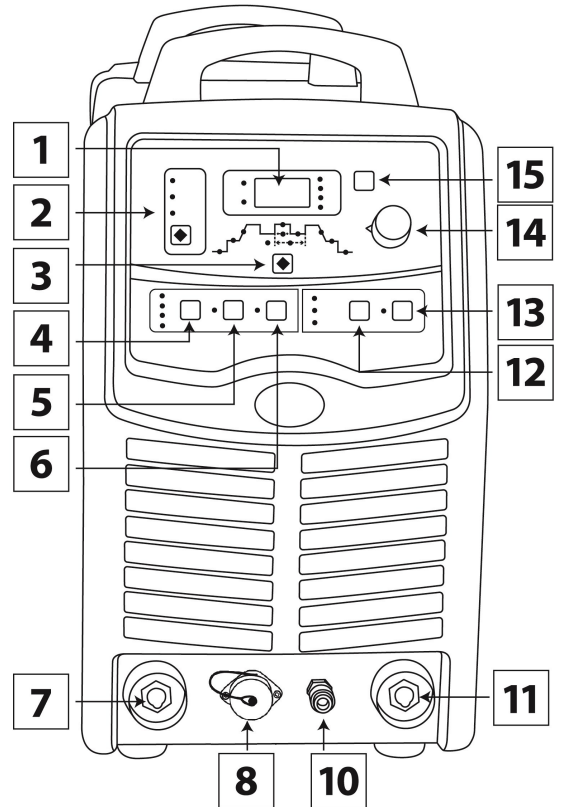

Rear view Jasic TIG 400P

16. Welding gas connection inlet
17. Mains power cable inlet
18. Power on/off switch
19. Fuse holder

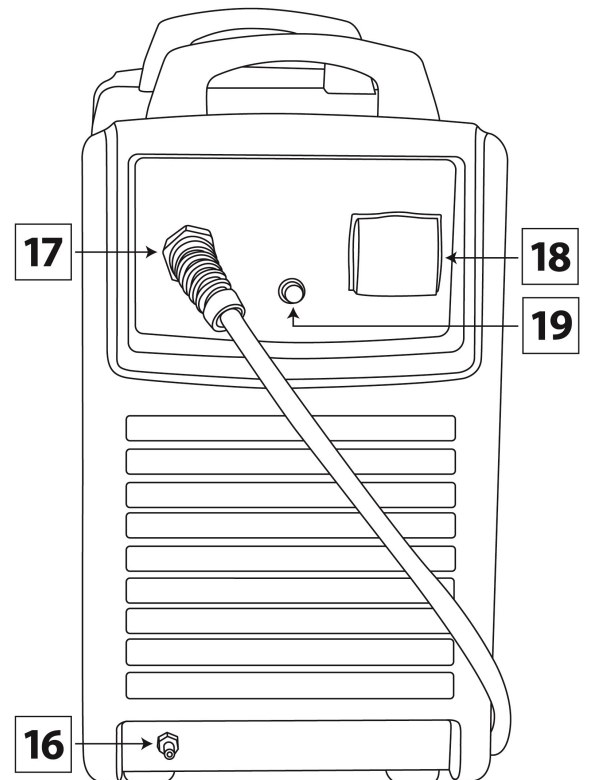

CONTROLS

Control panel view Jasic TIG 400P

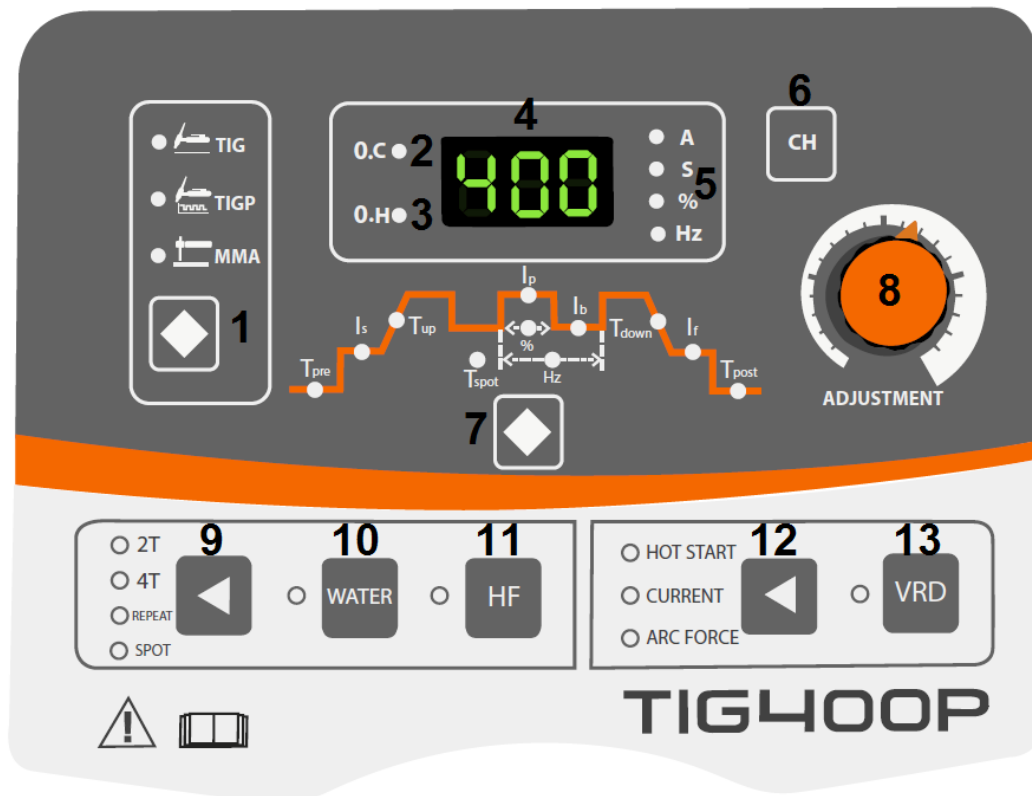

1. Welding mode selection zone: This area contains the welding mode indicators and selection switch
2. Overcurrent LED: The overcurrent LED indicates that the machine is under overcurrent protection status when illuminated
3. Thermal overload indicator: Overheating LED when on indicates that the temperature inside the machine is too high and the machine is under overheating protection status
4. Digital meter: Displays preset and actual current before and during welding. Also used to display parameter adjustment settings along with any error codes
5. Parameter selection indicators: When on these indicate that the selected parameter is ready to be adjusted on the digital display
6. CH switch: The TIG400P is equipped with 8 welding parameter storage channels for DC TIG, pulsed TIG and MMA
7. Parameter selection switch: Pressing this switch will highlight the LED of the parameter to be adjusted in the selection area via the control dial (8)
8. Parameter adjustment control dial: This control dial allows you to adjust the selected welding parameter to be adjusted via the rotary dial (8)
9. Latch/Spot selector switch: Use this selector to choose 2T, 4T, repeat or spot mode trigger modes
10. Water cooling switch: Using this switch will turn on/off the fitted TIG water cooler
11. HF arc ignition switch: When you press this switch and the indicator turns on, you have entered HF arc ignition, if the indicator is off, you are in lift arc TIG mode
12. MMA parameter selection zone: By pressing this switch you will have access to adjust hot start, current and arc force in MMA mode
13. VRD switch and indicator: By pressing the VRD switch in MMA mode the output voltage will be lowered to 19V DC

FUNCTIONS

Welding mode selection switch

Welding mode selection zone contains welding mode indicators and selection switch. Welding modes include TIG DC, TIG Pulse and MMA.

Press the welding mode selection key to choose the according welding mode. The welding mode being selected LED will be lit when selected and there is welding current flowing.

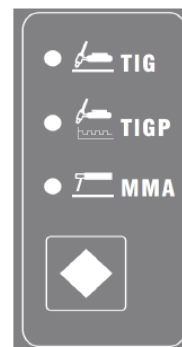

MMA parameters selection zone

This area contains the MMA parameters selection and VRD switch.

1. Ensure you are in MMA mode (as described above).
2. By pressing the  key you will circulate through hot start, current and arc force functions.
3. By pressing the VRD button, the indicator will come on and in MMA you will have entered VRD mode and OCV is now 19V.



These functions are not available in TIG and TIGP modes.

The display and parameter area

This area contains the display meter, unit parameters indicators and the warning indicator.

1. The window in the middle is a display to show all user parameters.
2. O.C on the left is over current protection indicator.
3. O.H on the left is over heat protection indicator.
4. A is current, S is time in seconds, % is percentage and Hz is frequency respectively.
5. Error codes will also be shown on this display.



TIG options selection zone

This zone include 3 parts: TIG torch trigger mode selection, water cooling switch key and arc ignition switch for either HF ignition or lift TIG arc starting.

1. TIG welding modes: 2T, 4T, repeat and spot. Press  to select the required welding mode.
2. Water cooling switch (TIG mode only for the JT-400P water cooled package).



- (a) Press the key and indicator is ON to enter water cooling mode.

When using a water cooled TIG torch the water cooling system will monitor the water flow and if for some reason the cooling tank is empty or flow stops or there is flow restriction then E-5 warning will show and the machines welding output will stop. The user should then check the cooling system.

- (b) Every time the user presses the 'water' key, the gas valve will function to offer gas purge.

3. Arc ignition type selection.

- (a) Press this key and when the indicator is ON, you have engaged HF arc ignition.

- (b) Press this key and when this indicator is OFF, you have entered lift arc ignition. When in this mode, place the torch to contact work piece, pull torch trigger then lift the torch slowly to achieve arc ignition.

FUNCTIONS

TIG parameters selection zone

Press  to circulate clockwise and select the required TIG parameter.

- Tpre: Pre flow time
- Is: Initial current
- Tup: Upslope time
- Ip: Peak current
- Ib: Base current
- Tdown: Downslope time
- If: Final current
- Tpost: Post flow time
- Hz: Pulse frequency
- %: Pulse duty factor
- Tspot: Spot welding time

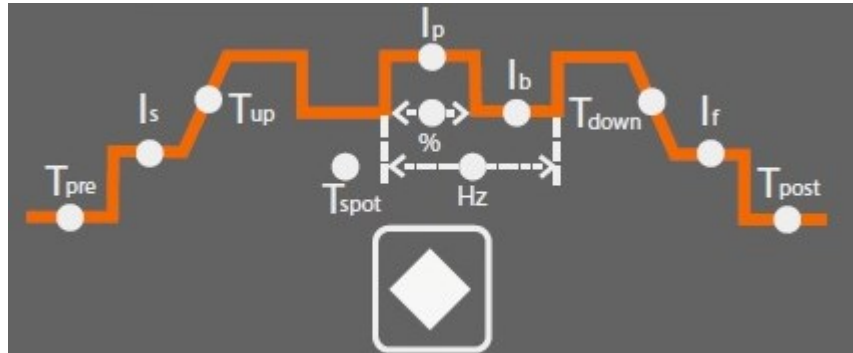

Please note: Ib, Hz & % is only available when in TIG pulse mode.

Parameter adjustment rotary knob

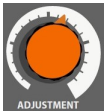

Parameter adjustment rotary knob is for adjusting all welding parameter available to the user.

Channel key



The TIG 400P is equipped with 8 welding parameters storage channels for DC TIG, Pulse TIG and DC MMA.

When the TIG 400P is turned on, it will be working in a certain stored channel which will be the channel previously used prior to being turned off.

To check the channel number, press the channel  key when the machine is in standby mode and the display window will show the current working channel. e.g. When the current working channel is number 6, then the display will show CH-6.

To change the channel number: press the channel key when machine is under standby and the display window will show the current working channel. Then change by using the rotary adjustment knob to change the working channel from either 1 to 8.

To exit channel management just re-press the CH key.

To load channel parameters press the channel key when machine is under standby mode and the display window will show the current working channel. Then adjust the rotary knob to change the working channel from 1 to 8. Re-press the CH key after selecting the required channel number and system will show all the parameters under this channel for operator's usage.

To store your channel parameters, this is done by choosing the required channel number then adjusting the required user welding parameters, the user then has to start the welding process to save the current parameters.

PLEASE NOTE

If the operator does not strike an arc after making parameter adjustments on a selected channel number, the system will not save the current parameters which means, if the machine is turned off then turned back on, it will automatically revert back to the previous channel number and welding parameters.

FUNCTIONS

Water cooler

The TIG 400P package is supplied with a TIG torch water cooler which mounts on a trolley with the Jasic inverter power source mounted above.

The water cooler front panel includes a work indicator, control fuse and connectors for water output (blue) and water input (red) quick connector.

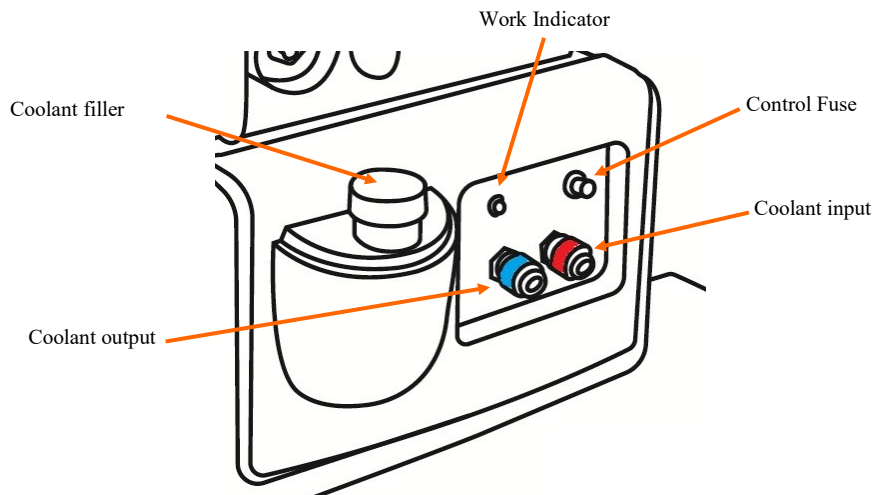

1. The work indicator is a visual means of letting the user know if the water cooler is in operation or not.
 - If the work indicator is ON, then the water cooler is pumping coolant around the TIG torch
 - If the work indicator is OFF, then it means the water cooler is not functioning.
2. The water cooler operation status is controlled by the Jasic power source. When the machine power source is under TIG water cooling, which is to say, the indicator is ON, the options are:
 - When there is current output from the power source the water cooler work indicator is on.
 - When the preset current is lower than 250A and also there is no current output, the water cooler will stop working after 2 minutes and the work indicator will be off.
 - When preset current is higher than 250A and also there is no current output, the water cooler will stop working after 4 minutes and the work indicator will be off.
 - When there is no water flow and also there is no current output, the water cooler will stop working after 10 minutes and the work indicator will be off.
3. The fuse rating is 5A.
4. Output (supply): This quick connector socket has a blue base and is used to connect to the water supply hose of the TIG torch quick connect plug (the TIG torch's blue quick connector or it may be labelled water supply hose).
5. Input (return): This quick connector socket has a red base and is used to connect the return water cooling hose of the TIG torch, this may be an extension of the power cable hose of the torch as this hose carries the returning 'hot' water from the torch via a dinse adaptor connected to the '-' dinse socket. See page 17 for connection layout.

Please Note:

The water cooler is not an optional extra for the Jasic TIG JT-400PA air cooled power source and cannot be added as an after market offering.

INSTALLATION

Unpacking

Check the packaging for any signs of damage.

Carefully remove the machine and retain the packaging until the installation is complete.

Location

The machine should be located in a suitable position and environment. Care should be taken to avoid moisture, dust, steam, oil or corrosive gases.

Place on a secure level surface and ensure that there is adequate clearance around the machine to ensure natural airflow.

Input connection

Before connecting the machine you should ensure that the correct supply is available.

Details of the machine requirements can be found on the data plate of the machine or in the technical parameters shown in the manual.

The equipment should be connected by a suitably qualified competent person. Always ensure the equipment has a proper grounding.

Never connect the machine to the mains supply with the panels removed.

Output connections

Electrode polarity

In general when using manual arc welding electrodes the electrode holder is connected to the positive terminal and the work return to the negative terminal.

"+" output terminal: For MMA connect the electrode holder

"-" output terminal: For MMA connect the work return lead

Always consult the electrode manufacturer's data sheet if you have any doubts.

When using the machine for TIG welding the TIG torch should be connected to the negative terminal and the work return to the positive terminal.

"+" output terminal: For TIG connect the work return lead

"-" output terminal: For TIG connect the TIG torch

Gas connections

Connect the gas hose to the regulator/flowmeter located on the shield gas cylinder and connect the other end to the TIG 400P input gas fitting on the rear panel of the machine.

Please Note:

Check these power connections daily to ensure they have not become loose otherwise arcing may occur when used under load.

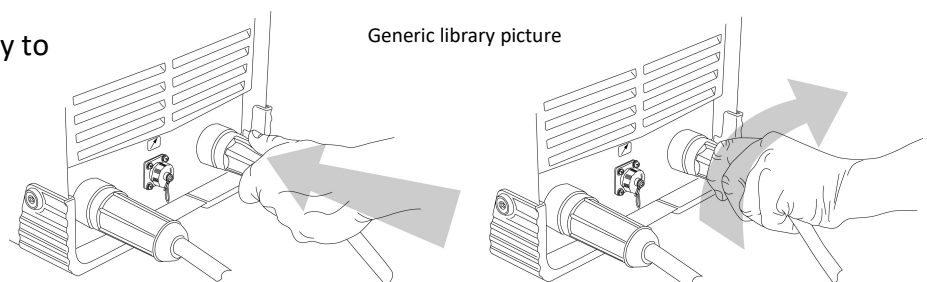

INSTALLATION

Machine set up for MMA and TIG Welding

MMA welding

This illustration right shows the set up for MMA stick welding.

Insert the cable plug with electrode holder into the “+” socket on the front panel of the welding machine and tighten it clockwise.

Insert the cable plug of the work return lead into the “-” socket on the front panel of the welding machine and tighten it clockwise as shown in the example shown.

TIG welding

The illustration below shows the set up for TIG welding for the water cooled package.

Insert the cable plug with the work clamp into the “+” socket on the front panel of the welding machine and tighten it clockwise.

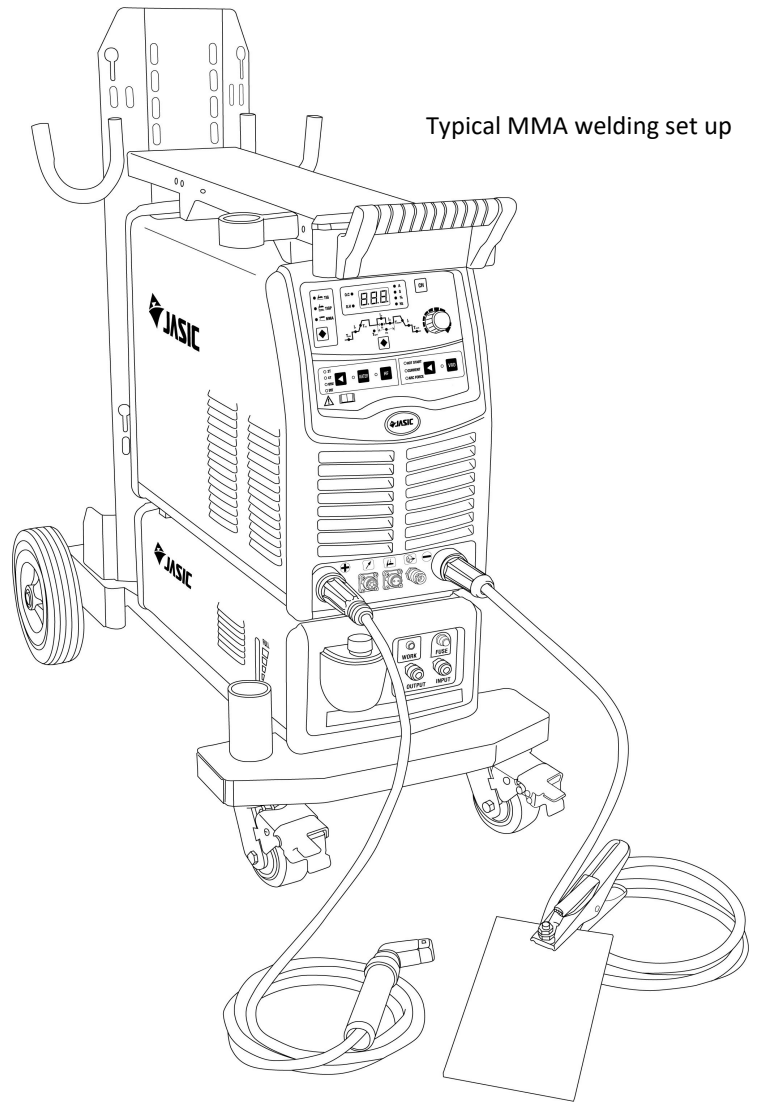

Typical MMA welding set up

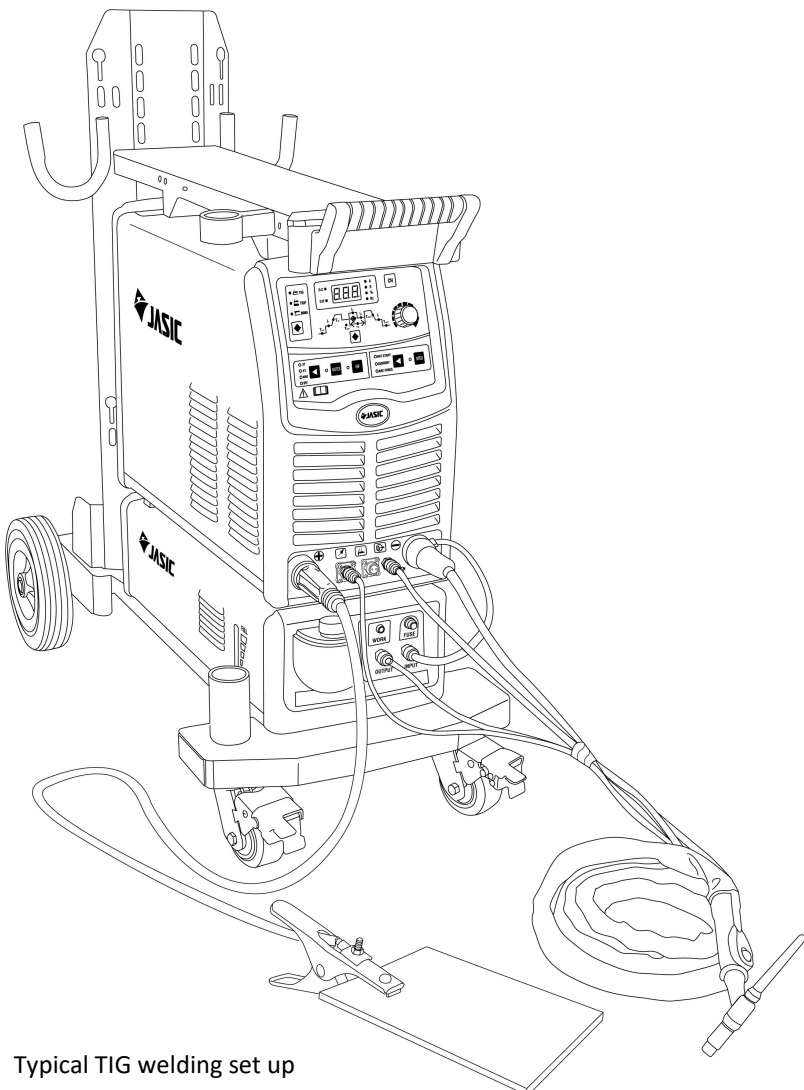

Typical TIG welding set up

Insert the power cable dinse adapter plug of the TIG torch into the “-” socket on the front panel of the machine and tighten clockwise.

Connect the gas quick connector into the outlet on the machine front.

Connect the torch switch plug into the socket on the front panel.

Connect the water supply hose of the TIG torch to the blue output quick connector on the front panel of the water cooler.

Connect the water hose from the dinse adapter/power cable of the TIG torch to the red input quick connector on the front panel of the water cooler.

Connect the gas hose to the regulator/flowmeter located on the shield gas cylinder and connect the other end of the hose to the gas input fitting mounted on the rear panel of the machine.

OPERATION - MMA



Before starting any welding activity ensure that you have suitable eye protection and protective clothing. Also take the necessary steps to protect any persons within the welding area.

MMA welding mode

Terms used: MMA (Manual Metal Arc),
SMAW (Shielded Metal Arc Welding)
Stick Welding.

Stick welding is an arc welding process which melts and joins metals by heating them with an arc between a covered metal electrode and the work.

Shielding is obtained from the electrode outer coating, often called flux. Filler metal is primarily obtained from the electrode core.

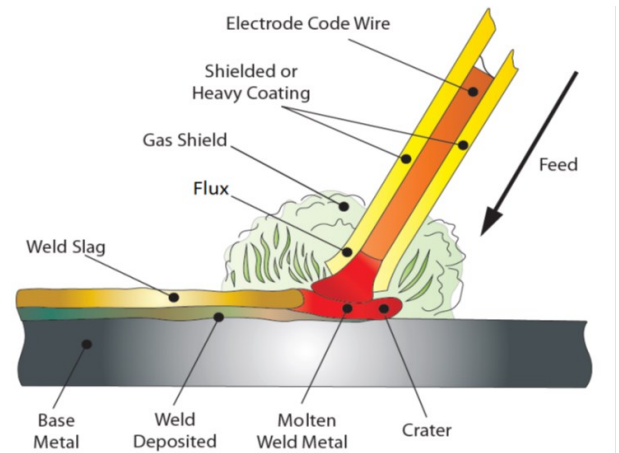

The electrodes outer coating called flux assists in creating the arc and provides a shielding gas, on cooling forms a slag covering to protect the weld from contamination.

When the electrode is moved along the work piece at the correct speed the metal core deposits a uniform layer called the weld bead.

After connecting the welding leads as detailed you will need to switch the power switch on the back panel to "ON".

Select MMA by pressing the mode switch to the MMA welding mode (See welding mode selection zone page 13). There is now voltage output at both output terminals.

- TIG
- TIGP
- MMA

Ensure you check that you have the electrode polarity correct and that you set the amperage on the machine suitable for the electrode being used.



Please see the guide below for amperages required, although this MMA welding electrode guide can vary depending on material, work piece thickness, welding position and joint form.

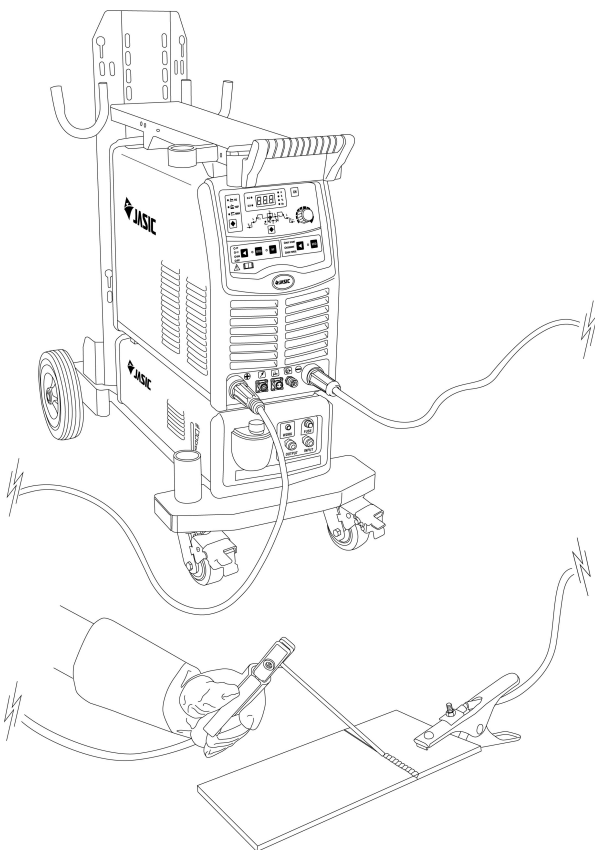

○ HOT START

○ CURRENT

○ ARC FORCE



The TIG400P also features hot start and arc force to ensure that you obtain the best MMA welding results, please see the following page which describes these welding parameters as shown above.

Electrode Diameter (mm)	Recommended Welding Current (A)	Recommended Welding Voltage (V)
1.0	20 ~ 60	20.8 ~ 22.4
1.6	44 ~ 84	21.76 ~ 23.46
2.0	60 ~ 100	22.4 ~ 24
2.5	80 ~ 120	23.2 ~ 24.8
3.2	108 ~ 148	24.32 ~ 24.92
4.0	140 ~ 180	24.6 ~ 27.2

OPERATION - MMA



Before starting any welding activity ensure that you have suitable eye protection and protective clothing. Also take the necessary steps to protect any persons within the welding area.

MMA welding mode

Turn on the power switch of the welding machine. The cooling fan will then start up and the display will light up.

Switch the welding mode switch on the front panel of the welding machine to MMA position.





The display meter will then show preset welding current.

Adjust the welding parameters to the appropriate values according to the welding applications.

After the above steps are finished, welding can be carried out. The current meter will display the actual welding current when the arc is established.

Attention: This machine is equipped with anti-sticking function. When arc voltage is too low and a short circuit occurs the machine output is reduced to 10A to prevent the electrode sticking enabling it to be broken away easily.

Welding parameters for MMA welding

Adjustable parameter	Adjusting range	Description
Arc ignition current <input checked="" type="radio"/> HOT START <input type="radio"/> CURRENT <input type="radio"/> ARC FORCE 	0-200A	When the selected arc ignition current is lower than the welding current, it will output the welding current automatically when igniting arc; when the selected arc ignition current is higher than the welding current, it will output the arc ignition current when igniting arc. If the arc ignition arc is overly low, it is hard to ignite arc and the success rate in arc ignition is low; if the arc ignition current is overly high, the work piece will be easily burned through. Therefore, the arc ignition current should be set properly according to practical.
Welding current <input type="radio"/> HOT START <input checked="" type="radio"/> CURRENT <input type="radio"/> ARC FORCE 	30-400A	The MMA output current control which allows the user to set his required current demand for MMA welding. The adjustment current range for MMA is 30 - 400 amps and once this is selected the current is adjusted via the rotary dial.
Arc force current <input type="radio"/> HOT START <input type="radio"/> CURRENT <input checked="" type="radio"/> ARC FORCE 	0-200A	If the arc force current is overly low, electrode sticking will occur during welding and the arc is weak; if the arc force current is overly high, excessive spatter will be caused. Therefore, the arc force current should be set according to the welding application.
VRD <input checked="" type="radio"/> VRD 	Reduces the OCV to 19V when the power supply is in idle	When MMA mode is selected and you press the VRD switch the VRD light will come on to indicate that VRD is on and your open circuit voltage (OCV) has reduced to 19V. Please note: When in TIG mode, VRD is off.

OPERATION - TIG



Before starting any welding activity ensure that you have suitable eye protection and protective clothing. Also take the necessary steps to protect any persons within the welding area.

TIG welding mode

Terms used: TIG – Tungsten Inert Gas.

GTAW – Gas Tungsten Arc Welding.

TIG welding is an arc welding process that uses a non-consumable tungsten electrode to produce the heat for welding. The weld area is protected from atmospheric contamination by a shielding gas (usually an inert gas such as argon or helium) and a filler rod matching the base material is normally used, though some welds, known as autogenous welds, are carried out without the need for filler wire.

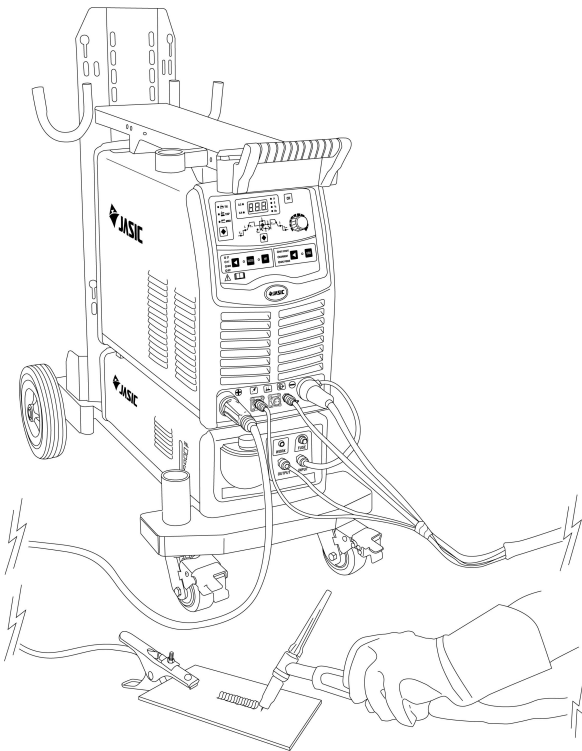
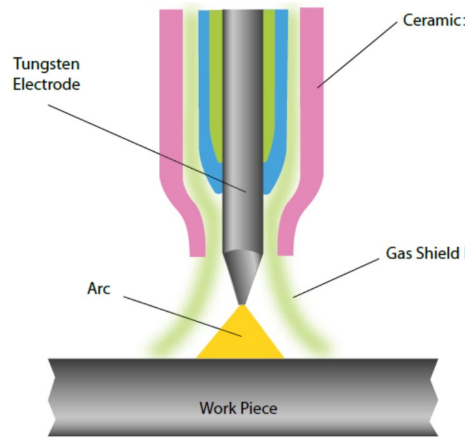

TIG process can be either:

- DC or AC modes (TIG 400P is DC only)
- DC - Direct current is for welding steel, stainless steel, copper etc.
- AC - Alternating current for welding aluminium and it's alloys.

To set the TIG 400P for TIG, connect the TIG torch leads as shown left.

Ensure that a suitable inert gas supply for your application is connected.

Turn the power switch located on the back panel to "ON", the machine will then power up with the display lighting up and the fan working.

Select TIG by pressing the MMA/TIG switch to TIG mode by pressing the switch to the TIG welding mode (see welding mode selection zone page 13).

Open the gas valve of the cylinder and adjust the gas regulator to obtain the desired flow rate.

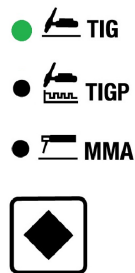

Press the torch trigger briefly, the solenoid valve will operate and gas will flow.

Adjust the welding current according to the tungsten and the thickness of the work material to be welded (for a guide to welding parameters, please refer to the table below).

Hold the torch 2-4mm away from the work piece and then press the torch trigger. After arc is ignited, the HF discharge will cease, the current will maintain the preset value and welding can be carried out.

After releasing the torch trigger, the welding arc stops but gas continues flowing for the post flow time and the welding ends.

Adjust the downslope time to change the time according to the welding process requirements.

The amperage guide for TIG welding tungsten sizes can vary depending on material, work piece thickness, welding position and joint form.

Tungsten Size	DC – Electrode Negative
1.0mm	15 – 80A
1.6mm	70 – 150A
2.4mm	150 – 250A
3.2mm	250A – 400A
4.0mm	400A – 500A
6.0mm	750A – 1000A

OPERATION - TIG



Before starting any welding activity ensure that you have suitable eye protection and protective clothing. Also take the necessary steps to protect any persons within the welding area.

TIG operation steps



Select the DC TIG mode by pressing the welding mode selecting key. 



TIGP



MMA



Select the 2T mode by pressing the operation mode selecting key. 

● 2T

○ 4T

○ REPEAT

○ SPOT



Select the pre flow time setting function by pressing the welding parameter selecting key and set the pre flow time. The gas pre flow parameter range is 0-15 seconds as indicated on the front panel digital display.

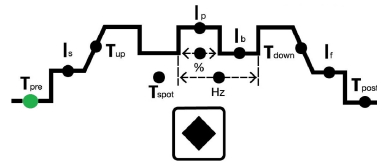

Select the initial current setting function by pressing the welding parameter selecting key and set the initial current. The initial current parameter range is 5-100 amps as indicated on the front panel digital display.

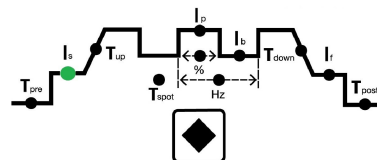

Select the upslope time setting function by pressing the welding parameter selecting key and set the upslope time. The upslope time parameter range is 0-10 seconds as indicated on the front panel digital display.

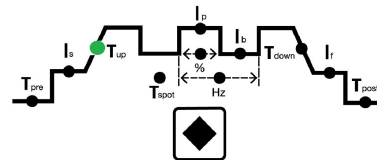

Select the welding current setting function by pressing the welding parameter selecting key and set the welding current. The welding current parameter range is 5-400 amps as indicated on the front panel digital display.

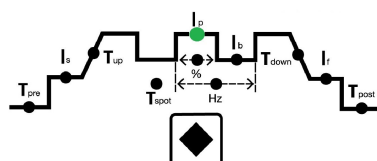

OPERATION - TIG



Before starting any welding activity ensure that you have suitable eye protection and protective clothing. Also take the necessary steps to protect any persons within the welding area.

TIG operation steps

Select the downslope time setting function by pressing the welding parameter selecting key and set the downslope time. The downslope parameter range is 0-10 seconds as indicated on the front panel digital display.

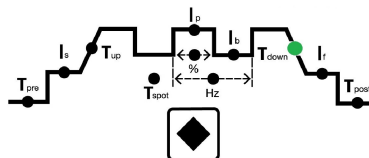

Select the crater current setting function by pressing the welding parameter selecting key and set the pilot arc current. The crater current parameter range is 5-400 amps as indicated on the front panel digital display.

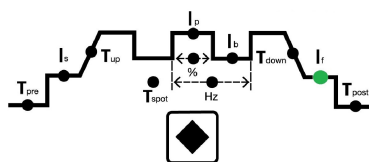

Select the post flow time setting function by pressing the welding parameter selecting key and set the post flow time. The gas post flow parameter range is 0-15 seconds as indicated on the front panel digital display.

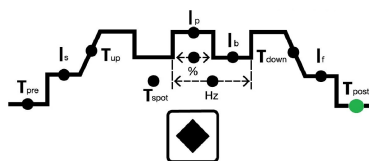

TIG spot welding

●  TIG Select the DC TIG mode by pressing the welding mode selecting key. 

●  TIGP

●  MMA



Select the spot mode by pressing the operation mode selecting key. 

○ 2T

○ 4T

○ REPEAT

● SPOT



Select the spot welding time setting function by pressing the welding parameter selecting key and set the spot time. The spot time parameter range is 0.1-10 seconds.

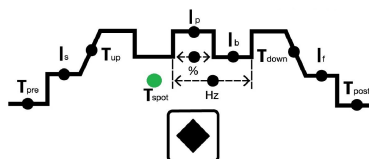

Please note: Spot welding can only be carried out HF TIG mode only.

OPERATION - TIG





Before starting any welding activity ensure that you have suitable eye protection and protective clothing. Also take the necessary steps to protect any persons within the welding area.

TIG operation steps

Pulse TIG

Select the pulsed TIG mode by pressing the welding mode selecting key  until TIGP lights up.

-  TIG
-  TIGP
-  MMA



2T

4T

REPEAT

SPOT



Then select the 2T mode by pressing the operation mode selecting key  until 2T lights up.

Proceed with the set up as for standard TIG. The welding current setting now becomes the peak welding current of the pulse. The next step will allow setting of the base current. This is only allowed when the pulse mode is selected.

Select the peak welding current setting function by pressing the welding parameter selecting key and set the peak welding current.

The peak welding current parameter range is 5-400 amps as indicated on the front panel digital display.

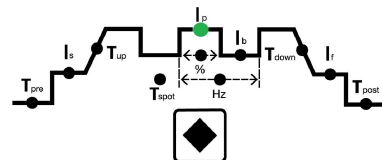

Select the base current setting function by pressing the welding parameter selecting key and set the base current.

The base current parameter range is 5-400 amps as indicated on the front panel digital display.

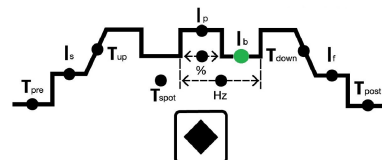

Select the downslope time, crater current and post flow gas time as standard TIG.

Select pulse duty ratio setting function by pressing the welding parameter selecting key and set the pulse duty ratio.

The pulse duration ratio parameter range is 10-90% as indicated on the front panel digital display.

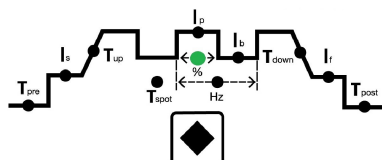

Select pulse frequency setting function by pressing the welding parameter selecting key and set the pulse frequency.

The pulse frequency parameter range is 0.5-200Hz as indicated on the front panel digital display.

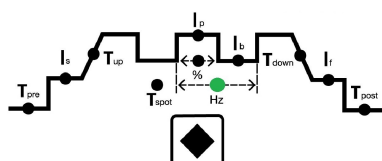

OPERATION - TIG



Before starting any welding activity ensure that you have suitable eye protection and protective clothing. Also take the necessary steps to protect any persons within the welding area.

TIG operation steps

HF and Lift TIG mode

The TIG 400P features HF arc ignition which is available in TIG 2T, 4T, Repeat and Spot modes. The 400P is also equipped with lift arc ignition, which is another form of arc starting the welding arc by allowing the tungsten to touch (short circuits) to the work piece with current being kept at a small level and then lifting the tungsten off the work piece to create arc ignition. The biggest advantage of this arc starting method is to avoid HF interference and lower work piece's tungsten pollution, but when compared with HF arc ignition it offers a lower successful rate. If unnecessary, please take HF arc ignition as your first choice.

Arc ignition type selection.

- ⇒ Press the HF switch and the indicator is on to enter TIG HF TIG arc ignition function.
- ⇒ Press the HF switch and indicator is off to enter lift TIG arc ignition function.



When in HF TIG mode (2T)

Keep the torch tungsten 2-4mm away from the work piece and then press and hold the torch trigger. Gas will flow followed by the high frequency (HF) and the arc is ignited. Once the arc is ignited the HF will cease and the current rises up to the preset values set by the user and welding is then carried out. After releasing the torch trigger, the current begins to decrease automatically to the final (crater) current value. The welding arc will then stop with gas still flowing until the gas post flow time ends and welding is finished.

When in lift TIG mode (2T)

In this mode, place the torch tungsten in contact with the work piece and then press and hold the torch trigger. Gas will flow and then you can lift the tungsten slowly away from the work piece to initiate the welding arc and the current rises up to the preset values set by the user and welding is then carried out. After releasing the torch trigger, the current begins to decrease automatically to the final (crater) current value. The welding arc will then stop with gas still flowing until the gas post flow time ends and welding is finished.

OPERATION - TIG



Before starting any welding activity ensure that you have suitable eye protection and protective clothing. Also take the necessary steps to protect any persons within the welding area.

TIG operation steps

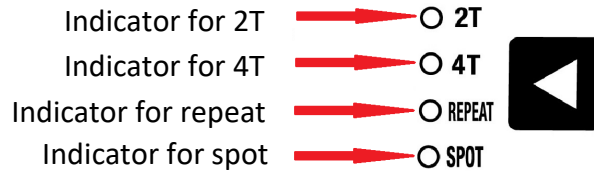

2T (normal trigger control)

The 2T light will illuminate when the power source is in 2T welding mode. In this mode, the torch trigger must remain pressed (closed) for the welding output to be active. See example below:

Press and hold the torch trigger to activate the power source, the gas valve and gas will flow. After the gas pre flow time ends, HF discharge begins and then the welding arc will ignite and then the current rises up (slope up time) to the welding current value gradually until you achieve the preset welding current.

When the torch switch is released, the current begins to drop gradually (slope down time) and when it drops to the minimum current value, the welding output is cut off and the gas valve will close, once the post flow time ends, this is the end of the welding process.

If the torch switch is pressed down during the current downslope period, the current will rise up again to the preset welding current value and the slope out process will only start again once the torch switch to be released.

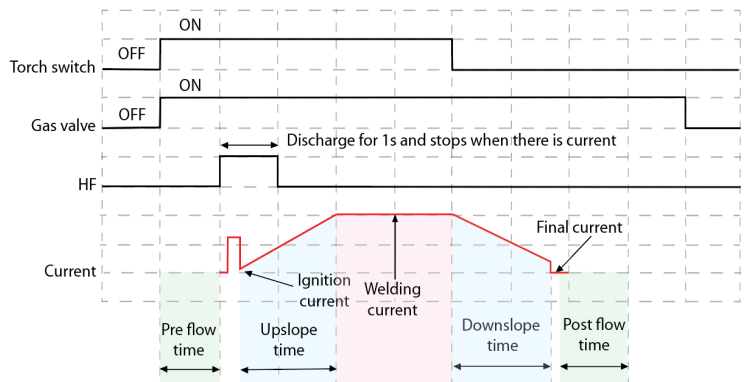

4T (latch trigger control)

The 4T light will illuminate when the power source is in 4T welding mode, this trigger mode is mainly used for long welding runs to assist in reducing operator finger fatigue. In this mode the user can press and release the torch trigger and the output will remain active until the trigger switch is depressed again and released.

In 4T mode, the gas valve opens when the torch switch is pressed down, after the pre flow time ends, HF discharge occurs which ignites the welding arc. Once the welding arc has successfully ignited the initial current value is active and the torch switch can now be released, the welding current rises up to the preset welding current value gradually and you will continue to weld your material. To finish welding, simply press the torch switch down again and the current will begin to gradually drop (slope out time) to the final current value. When the torch switch is released the current output is cut off and the gas will continue to flow until your preset post flow time has elapsed.

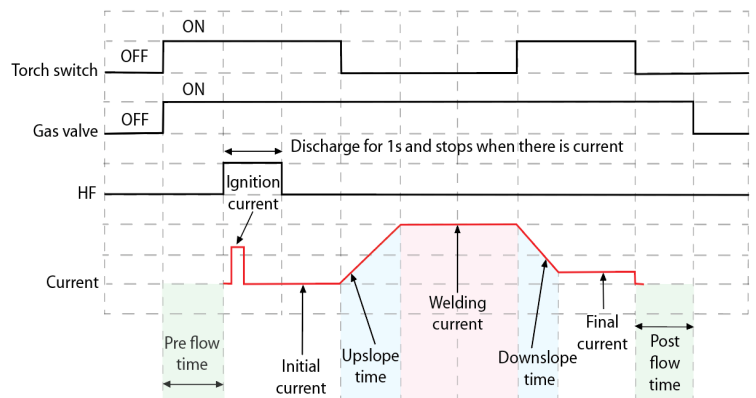

OPERATION - TIG



Before starting any welding activity ensure that you have suitable eye protection and protective clothing. Also take the necessary steps to protect any persons within the welding area.

TIG operation steps

Repeat

The repeat light will illuminate when the power source is in repeating mode, upon pressing the torch trigger switch the gas valve opens and after the pre flow time ends, HF discharge will engage the welding arc. Once the welding arc is ignited successfully, the initial current is present then after the operator releases the torch switch the welding current rises up to the preset welding current value gradually (depending on preset upslope time). When the torch switch is pressed down again, the current begins to drop gradually to the final current arc value.

When the torch switch is released again, the current will rise gradually up to the welding current value again. 'Repeating' means the welding current varies between the final arc current value and the welding current value.

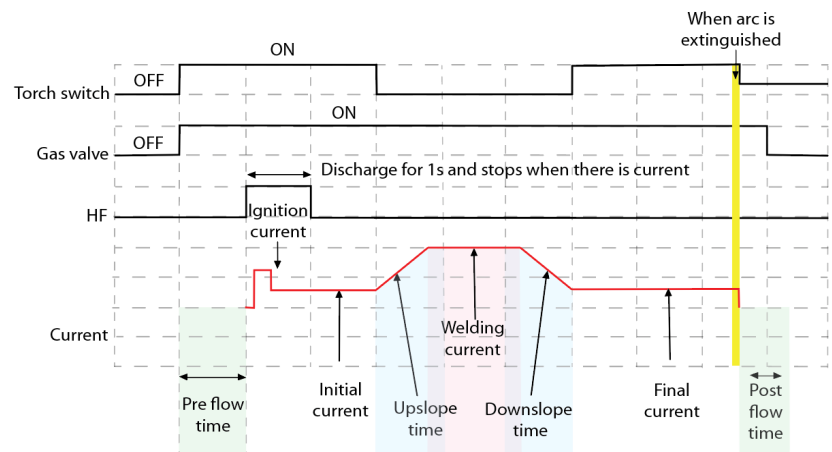

To extinguish the welding arc, press and release the torch trigger briefly (within 1/5 of a second) and the arc will be extinguished immediately and the current output will be shut off. The gas valve will then close when the post flow time ends and the welding process ends.

Spot welding

The spot light will illuminate when the power source is in spot welding mode. To set the spot welding time setting, refer to page 20 for selecting and setting the spot time.

On pressing the torch trigger, gas will flow and at the end of the gas pre flow time HF will initiate the welding arc.

Once the welding arc is ignited the welding current is present and no matter if the torch switch is on or off the machine will still offer welding current until the preset spot welding time the user set has timed out and then the welding arc will be extinguished. The gas will continue until the post flow time ends when the welding process ends.

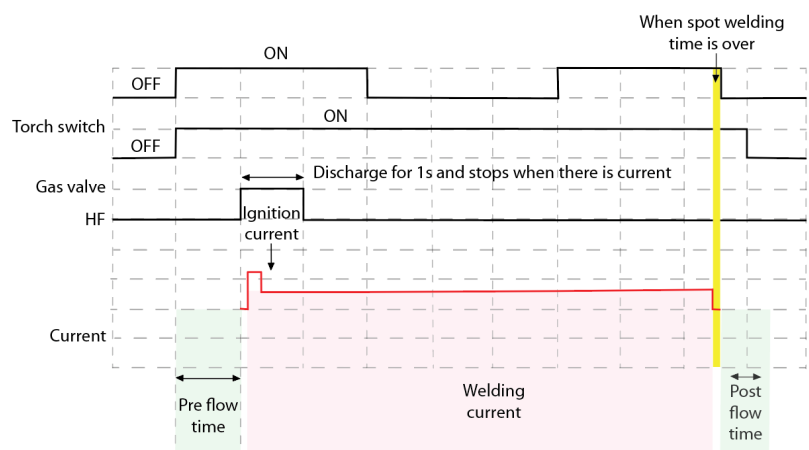

Please note: Lift arc ignition is not available in spot welding.

REMOTE CONTROL SOCKET



Before starting any welding activity ensure that you have suitable eye protection and protective clothing. Also take the necessary steps to protect any persons within the welding area.

TIG 400P remote control socket

- The 9 pin control socket located on the front panel is used to connect the TIG torch trigger plug, this socket can also be used to connect a TIG torch with inbuilt remote current control as well as a foot pedal or similar remote device.



Optional

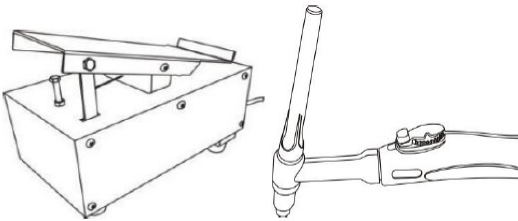

Remote current control

Plug the TIG torch or the foot pedal's 9 pin plug into the matching socket mounted on the front of the 400P and you are now in remote current control mode.

9 Pin Remote Plug Wiring	
Pin No	Description
1	Potentiometer (min)
2	Potentiometer wiper
3	Potentiometer (max)
4	Link with pin 5
5	Link with pin 4
6	N/A
7	N/A
8	Torch switch
9	Torch switch

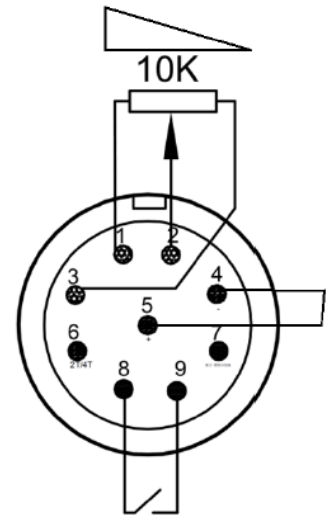

Remote plug wiring configuration

Foot pedal operation

Upon connecting the foot pedal control plug into the 9 pin remote socket, set the machine torch mode to 2T. Press the foot pedal down to start the machine output functions. The foot control potentiometer controls the welding current up to the preset level already set on the welding power source control panel. The panel digital ammeter will only display minimum preview amps until the foot control is depressed then it displays actual welding current when welding.

Pressing the foot pedal increases the welding current, letting up on the foot pedal decreases the welding current then releasing the pedal completely will extinguish the arc which in turn will initiate the post flow shielding gas time.

TIG torch with remote current control operation

Upon connecting the TIG torch control plug into the 9 pin remote socket, set the machine torch mode to 2T. Press the torch switch with your index finger to start the machine welding. Then using your thumb on the potentiometer control to either increase or decrease the welding current to the desired level of your application in which the current will be noted on the control panels ammeter.

Please note: The maximum output current must be set on the power source control panel by the user prior to the foot control pedal being connected.

When in TIG 2T mode with the optional TIG torch with remote or with a foot pedal connected to the machine you then have the ability of manually controlling the slope up/down time and welding current during TIG welding mode.

The welding current and slope times are determined by the user by either pressing and depressing the foot pedal or using the current control thumb wheel on the TIG torch handle.

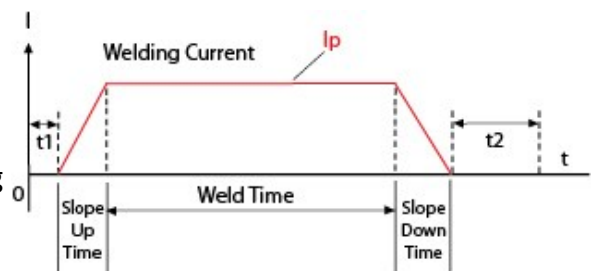

GUIDE TO MMA WELDING



Before starting any welding activity ensure that you have suitable eye protection and protective clothing. Also take the necessary steps to protect any persons within the welding area.

Notes for the welding beginner

This section is designed to give the beginner who has not yet done any welding some information to get them going. The simplest way to start is to practice by running weld beads on a piece of scrap plate. Start by using mild steel (paint free) plate of 6.0mm thick and using 3.2mm electrodes. Clean any grease, oil and loose scale from the plate and fix firmly to your work bench so that welding can be carried out. Make sure that the work return clamp is secure and making good electrical contact with the mild steel plate, either directly or through the work table. For best results always clamp the work lead directly to the material being welded, otherwise a poor electrical circuit may create itself.

Welding position

When welding, ensure you place yourself in a comfortable position for welding and your welding application before you begin to weld. This may be by sitting at a suitable height which often is the best way to weld ensuring you're relaxed and not tense. A relaxed posture will ensure the welding task becomes much easier.

Please ensure you always wear suitable PPE and use suitable fume extraction when welding.

Place the work so that the direction of welding is across, rather than to or from your body. The electrode holder lead should always be clear of any obstruction so that you can move your arm freely along as the electrode burns down. Some welders prefer to have the welding lead over their shoulder, this allows greater freedom of movement and can reduce the weight from your hand.

Always inspect your welding equipment, welding cables and electrode holder before each use to ensure it's not faulty or worn as you may be at risk of an electric shock.

MMA process features and benefits

The versatility of the process and the skill level required to learn, basic simplicity of the equipment make the MMA process one of the most common used throughout the world.

The MMA process can be used to weld a wide variety of materials and is normally used in the horizontal position but can be used in vertical or overhead with the correct selection of electrode and current. In addition, it can be used to weld at long distances from the power source subject to the correct cable sizing. The self shielding effect of the electrode coating makes the process suitable for welding in external environments. It is the dominant process used in maintenance and repair industries and is used extensively in structural and fabrication work.

The process is well able to cope with less than ideal material conditions such as dirty or rusty material. Disadvantages of the process are the short welds, slag removal and stop/starts which lead to poor weld efficiency which is in the region of 25%. The weld quality is also highly dependent on the skill of the operator and many welding problems can exist.

GUIDE TO MMA WELDING



Before starting any welding activity ensure that you have suitable eye protection and protective clothing. Also take the necessary steps to protect any persons within the welding area.

MMA process tips and guides

Typical welder set up

1. Electrode holder
2. Work return clamp
3. Work piece
4. Weld material covered by electrode flux or slag
5. Electrode
6. Distance from work to electrode (arc Length)

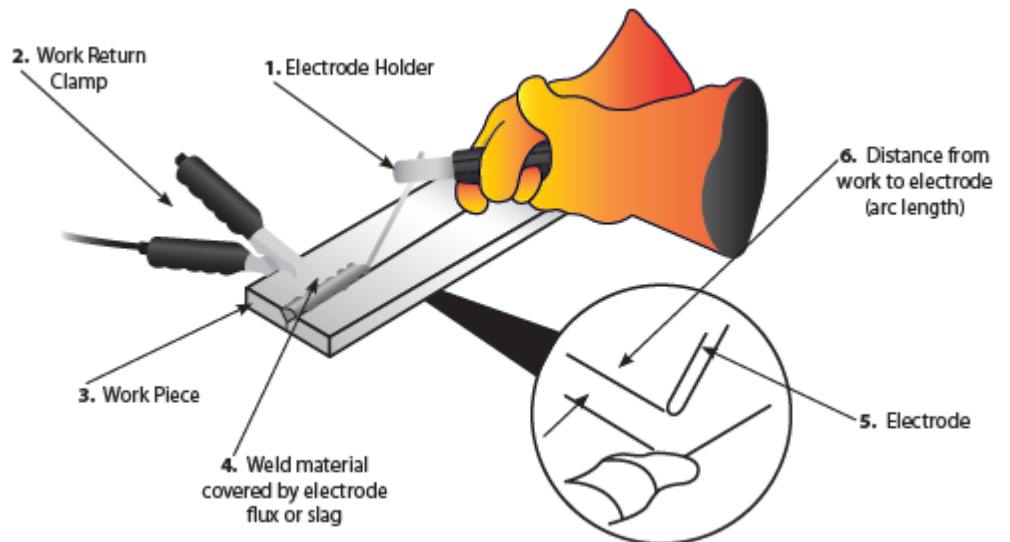

Welding current will flow in the circuit as soon as the electrode contacts the work piece. The welder should always ensure a good connection of the work clamp. The nearer the clamp is placed to the welding area the better.

When the arc is struck the distance between the end of the electrode and the work will determine the arc voltage and also affect the weld characteristic. As a guide the arc length for electrodes up to 3.2mm diameter should be around 1.6mm and over 3.2mm around 3mm.

Upon completion of the weld the welding flux or slag will need to be removed usually with a chipping hammer and wire brush.

Joint form in MMA

In MMA welding, the common basic joint forms: butt joint, corner joint, lap joint & T joint.

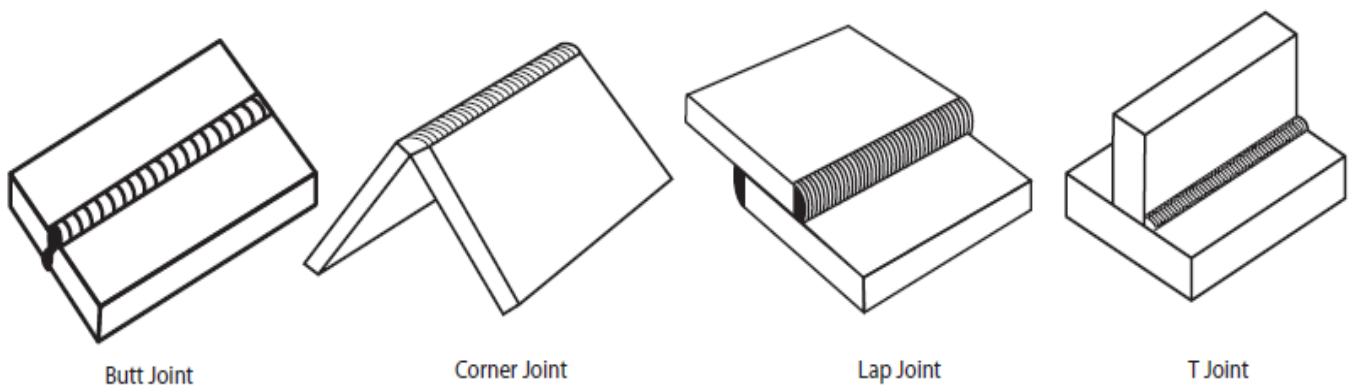

Butt Joint

Corner Joint

Lap Joint

T Joint

GUIDE TO MMA WELDING



Before starting any welding activity ensure that you have suitable eye protection and protective clothing. Also take the necessary steps to protect any persons within the welding area.

MMA arc striking

Tap technique - Lift the electrode upright and bring it down to strike the work piece. After forming short circuit, quickly lift up about 2~4mm and arc will be ignited. This method is difficult to master.

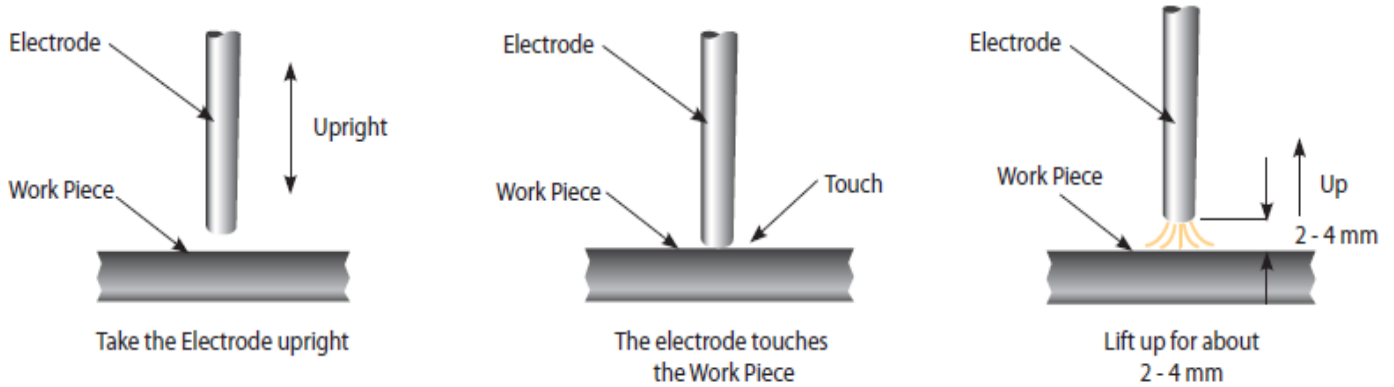

Scratch technique - Drag the electrode and scratch the work piece as if striking a match. Scratching the electrode may cause the arc to burn along the scratch path, so care should be taken to scratch in the weld zone. When the arc is struck adopt the correct welding position.

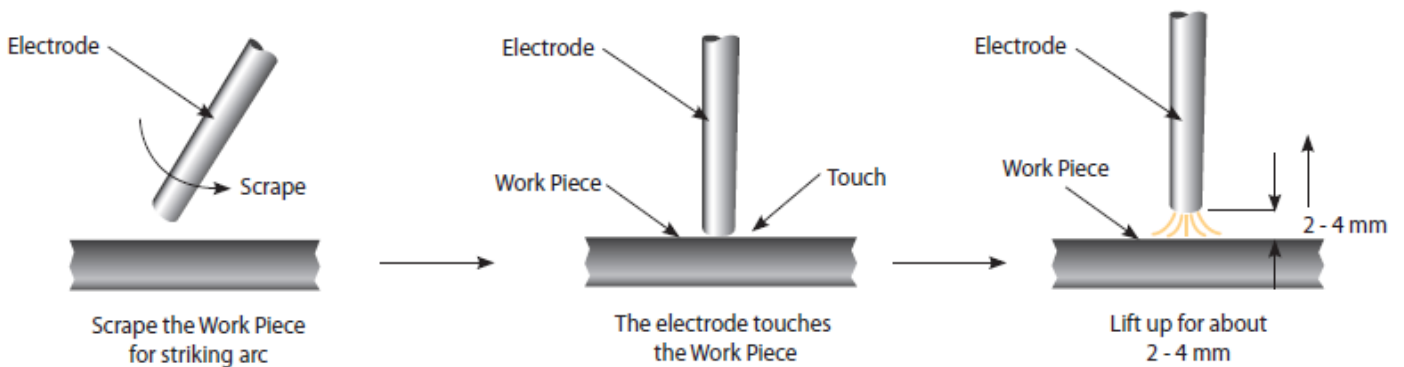

Electrode positioning

Horizontal or flat position

The electrode should be positioned at right angles to the plate and inclined in the direction of travel at around 10°-30°.

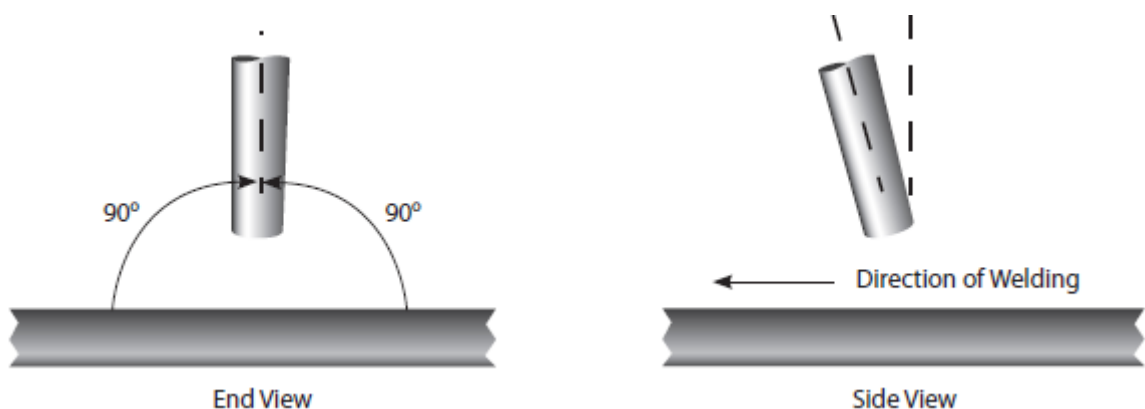

GUIDE TO MMA WELDING



Before starting any welding activity ensure that you have suitable eye protection and protective clothing. Also take the necessary steps to protect any persons within the welding area.

Fillet welding

The electrode should be positioned to split the angle i.e. 45° . Again the electrode should be inclined in the direction of travel at around 10° - 30° .

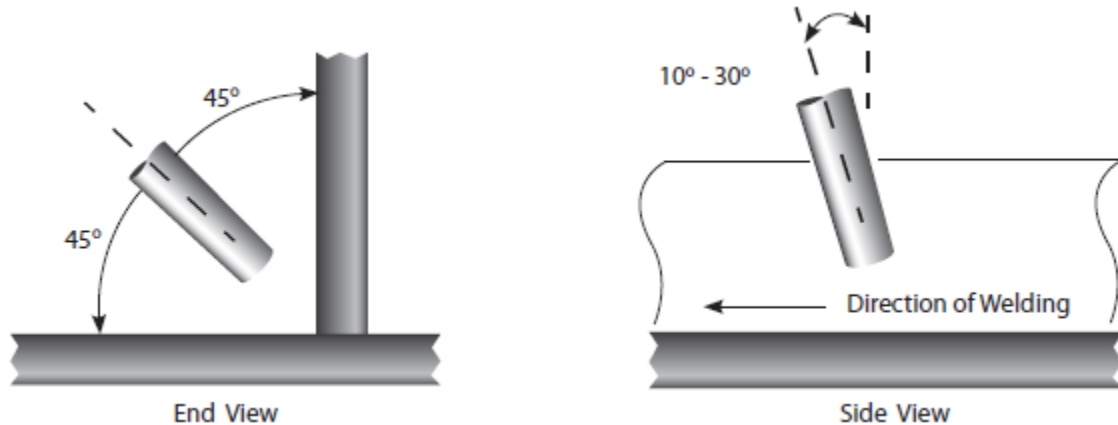

Manipulation of electrode

In MMA welding there are three motions used at the end of electrode:

1. The electrode feeding to the molten pool along axis
2. The electrode swing right and left
3. The electrode moving in the weld direction

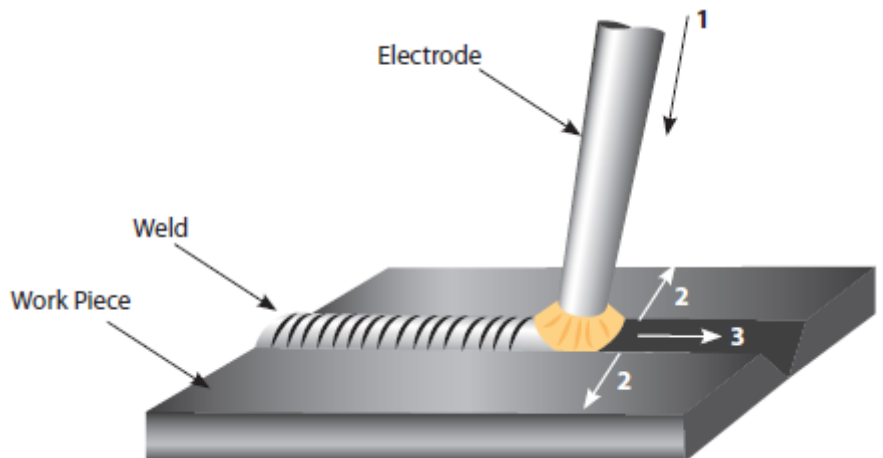

The operator can choose the manipulation of electrode based on welding joint, welding position, electrode spec, welding current and operation skill etc.

Weld characteristics

A good weld bead should exhibit the following characteristics:

1. Uniform weld bead
2. Good penetration into the base material
3. No overlap
4. Fine spatter level

A poor weld bead should exhibit the following characteristics:

1. Uneven and erratic bead
2. Poor penetration into the base material
3. Bad overlap
4. Excessive spatter levels
5. Weld crater

MMA WELDING PROBLEMS



Before starting any welding activity ensure that you have suitable eye protection and protective clothing. Also take the necessary steps to protect any persons within the welding area.

Arc welding defects and prevention methods

<u>Defect</u>	<u>Possible cause</u>	<u>Action</u>
Excessive spatter (beads of metal scattered around the weld area)	Amperage too high for the selected electrode	Reduce amperage or utilise larger diameter electrode
	Voltage too high or arc length too long	Reduce arc length or voltage
Uneven and erratic weld bead and direction	Weld bead is inconsistent and misses joint due to operator	Operator training required
Lack of penetration – The weld bead fails to create complete fusion between material to be welded, often surface appears okay but weld depth is shallow	Poor joint preparation	Joint design must allow for full access to the root of the weld
	Insufficient heat input	Material too thick Increase the amperage or increase the electrode size and amperage
	Poor weld technique	Reduce travel speed Ensure the arc is on the leading edge of the weld puddle
Porosity – Small holes or cavities on the surface or within the weld material	Work piece dirty	Remove all contaminant from the material i.e. oil, grease, rust, moisture prior to welding
	Electrode is damp	Replace or dry the electrode
	Arc length is excessive	Reduce the arc length
Excessive penetration – The weld metal is below the surface level of the material and hangs below	Heat input too high	Reduce the amperage or use a smaller electrode and lower amperage
	Poor weld technique	Use correct welding travel speed
Burning through – Holes within the material where no weld exists	Heat input too high	Use lower amperage or smaller electrode Use correct welding travel speed
Poor fusion – Failing of weld material to fuse either with the material to be welded or previous weld beads	Insufficient heat level	Increase the amperage or increase the electrode size and amperage
	Poor welding technique	Joint design must allow for full access to the root of the weld Alter welding technique to ensure penetration such as weaving, arc positioning or stringer bead technique
	Work piece dirty	Remove all contaminant from the material i.e. oil, grease, rust, moisture prior to welding

GUIDE TO DC TIG WELDING



Before starting any welding activity ensure that you have suitable eye protection and protective clothing. Also take the necessary steps to protect any persons within the welding area.

DC TIG welding

Direct current welding is when the current flows in one direction only. Compared with AC welding the current once flowing will not go to zero until welding has ended.

The Jasic TIG Series polarity should generally be set up for Direct Current - Electrode Negative (DCEN) as this method of welding can be used for a wide range of materials.

The TIG welding torch is connected to the negative output of the machine and the work return cable to the positive output.

When the arc is established the current flows in the circuit and the heat distribution in the arc is around 33% in the negative side of the arc (the welding torch) and 67% in the positive side of the arc (the work piece). This balance gives deep arc penetration of the arc into the work piece and reduces heat in the electrode.

This reduced heat in the electrode allows more current to be carried by smaller electrodes compared to other polarity connections. This method of connection is often referred to as straight polarity and is the most common connection used in DC welding.

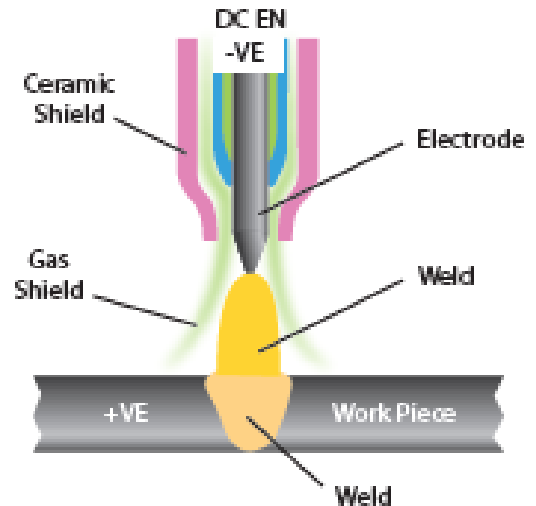

TIG welding techniques

- Before welding (especially with mild steel) you should ensure all material being welded are clean, as particulates can weaken the weld.
- The torch angle is best kept at 15 - 20° (from vertical) away from the direction of travel. This assists with visibility of the weld area and allows easier access for the filler material.
- The filler metal should be fed in at a low angle to help avoid touching the tungsten electrode and contaminating it.
- The TIG welding arc melts the base material and the molten puddle melts the filler rod, it is important you resist the urge to melt the filler material directly into the welding arc.
- For thinner sheet materials, a filler material may not be needed.
- Prepare the tungsten correctly, using a diamond grinding wheel will give you the best results for a sharp point (see page 35).
- For welding stainless steel, be careful of applying too much heat. If the colour is dark grey and looks dirty and heavily oxidized then too much heat has been applied, this could also cause the material to warp. Reducing the amperage and increase travel speed may correct this problem, you could also consider using a smaller diameter filler material, as that will require less energy to melt.

See the following page for a TIG DC welding amperage guide

GUIDE TO DC TIG WELDING



Before starting any welding activity ensure that you have suitable eye protection and protective clothing. Also take the necessary steps to protect any persons within the welding area.

Manual DC TIG Welding Amperage Guide- Mild Steel and Stainless Steel

Base Metal Thickness mm	Base Metal Thickness Inch	Tungsten Electrode Diameter	Output Polarity	Filler Wire Diameter (If Required)	Argon Gas Flow Rate (Litres/Min)	Joint Types	Amperage Range
1.6mm	1/16"	1.6mm	DC	1.6mm	5 - 8	Butt	50 - 80
1.6mm	1/16"	1.6mm	DC	1.6mm	5 - 8	Corner	50 - 80
1.6mm	1/16"	1.6mm	DC	1.6mm	5 - 8	Fillet	60 - 90
1.6mm	1/16"	1.6mm	DC	1.6mm	5 - 8	Lap	60 - 90
2.4mm	3/32"	1.6/2.4mm	DC	1.6/2.4mm	5 - 9	Butt	80 - 110
2.4mm	3/32"	1.6/2.4mm	DC	1.6/2.4mm	5 - 9	Corner	80 - 110
2.4mm	3/32"	1.6/2.4mm	DC	1.6/2.4mm	5 - 9	Fillet	90 - 120
2.4mm	3/32"	1.6/2.4mm	DC	1.6/2.4mm	5 - 9	Lap	90 - 120
3.2mm	1/8"	2.4mm	DC	2.4mm	5 - 10	Butt	80 - 120
3.2mm	1/8"	2.4mm	DC	2.4mm	5 - 10	Corner	90 - 120
3.2mm	1/8"	2.4mm	DC	2.4mm	5 - 10	Fillet	100 - 140
3.2mm	1/8"	2.4mm	DC	2.4mm	5 - 10	Lap	100 - 140
4.8mm	3/16"	2.4mm	DC	2.4mm	6 - 11	Butt	120 - 200
4.8mm	3/16"	2.4mm	DC	2.4mm	6 - 11	Corner	150 - 200
4.8mm	3/16"	2.4mm	DC	2.4mm	6 - 11	Fillet	170 - 220
4.8mm	3/16"	2.4mm	DC	2.4mm	6 - 11	Lap	150 - 200
6.4mm	1/4"	2.4mm	DC	3.2mm	7 - 12	Butt	225 - 300
6.4mm	1/4"	2.4mm	DC	3.2mm	7 - 12	Corner	250 - 300
6.4mm	1/4"	2.4mm	DC	3.2mm	7 - 12	Fillet	250 - 320
6.4mm	1/4"	2.4mm	DC	3.2mm	7 - 12	Lap	250 - 320
9.5mm	3/8"	3.2mm	DC	3.2mm	7 - 12	Butt	250 - 360
9.5mm	3/8"	3.2mm	DC	3.2mm	7 - 12	Corner	260 - 360
9.5mm	3/8"	3.2mm	DC	3.2mm	7 - 12	Fillet	270 - 380
9.5mm	3/8"	3.2mm	DC	3.2mm	7 - 12	Lap	230 - 380
12.7mm	1/2"	3.2/4mm	DC	3.2mm	8 - 13	Butt	300 - 400
12.7mm	1/2"	3.2/4mm	DC	3.2mm	8 - 13	Corner	320 - 420
12.7mm	1/2"	3.2/4mm	DC	3.2mm	8 - 13	Fillet	320—420
12.7mm	1/2"	3.2/4mm	DC	3.2mm	8 - 13	Lap	320 - 420

Please Note:

- All above guide settings are approximate and will vary depending on application, prep, passes and type of welding equipment used.
- The welds would need to be tested to ensure they comply to your welding specifications.

GUIDE TO TIG WELDING



Before starting any welding activity ensure that you have suitable eye protection and protective clothing. Also take the necessary steps to protect any persons within the welding area.

TIG torch body and components

The torch body holds the various welding consumables in place as shown and is covered by either a rigid phenolic or rubberised covering.

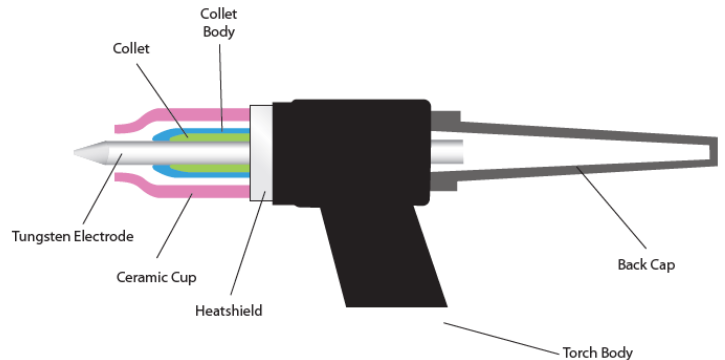

Collet body



The collet body screws into the torch body. It is replaceable and is changed to accommodate the different sizes tungstens and their respective collets.

Collets



The welding electrode (tungsten) is held in the torch by the collet. The collet is usually made of copper or a copper alloy. The collet's grip on the electrode is secured when the torch back cap is tightened in place. Good electrical contact between the collet and tungsten electrode is essential for good welding current transfer.

Gas lens body

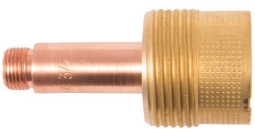

A gas lens is a device that can be used in place of the normal collet body. It screws into the torch body and is used to reduce turbulence in the flow of shield gas and produce a stiff column of undisturbed flow of shielding gas. A gas lens will allow the welder to move the nozzle further away from the joint allowing increased visibility of the arc.

A much larger diameter nozzle can be used which will produce a large blanket of shielding gas. This can be very useful in welding material like titanium. The gas lens will also enable the welder to reach joints with limited access such as inside corners.

Ceramic cups



Gas cups are made of various types of heat resistant materials in different shapes, diameters and lengths. The cups are either screwed onto the collet body or gas lens body or in some cases pushed in place. Cups can be made of ceramic, metal, metal-jacketed ceramic, glass or other materials. The ceramic type is quite easily broken so take care when putting the torch down.

Gas cups must be large enough to provide adequate shielding gas coverage to the weld pool and surrounding area. A cup of a given size will allow only a given amount of gas to flow before the gas flow becomes disturbed due to the speed of flow. Should this condition exist the size of cup should be increased to allow the flow speed to reduce and once again establish an effective regular shield.

Back cap

The back cap screws into the rear on the torch head and applies pressure to the back end of the collet which in turn forces up against the collet body, the resulting pressure holds the tungsten in place to ensure it does not move during the welding process.

Back caps are made from a rigid phenolic material and generally come in 3 sizes, short, medium and long.

GUIDE TO TIG WELDING



Before starting any welding activity ensure that you have suitable eye protection and protective clothing. Also take the necessary steps to protect any persons within the welding area.

TIG welding electrodes

TIG welding electrodes are a 'non consumable' as it is not melted into the weld pool and great care should be taken not to let the electrode contact the welding pool to avoid weld contamination. This would be referred to as tungsten inclusion and may result in weld failure.

Electrodes will often contain small quantities of metallic oxides which can offer the following benefits:

- Assist in arc starting
- Improve current carrying capacity of the electrode
- Reduce the risk of weld contamination
- Increase electrode life
- Increase arc stability

Oxides used are primarily zirconium, thorium, lanthanum or cerium. These are added usually 1% - 4%.



Tungsten Electrode Colour Chart - DC

Welding Mode	Tungsten Type	Colour
DC or AC/DC	Ceriated 2%	Grey
DC or AC/DC	Lanthanated 1%	Black
DC or AC/DC	Lanthanated 1.5%	Gold
DC or AC/DC	Lanthanated 2%	Blue
DC	Thoriated 1%	Yellow
DC	Thoriated 2%	Red

Tungsten Electrode Current Ranges

Tungsten Electrode Size	DC Current Amp
1.0mm	30 - 60
1.6mm	60 - 115
2.4mm	100 - 165
3.2mm	135 - 200
4.0mm	190 - 280
4.8mm	250 - 340

Tungsten electrode preparation - DC

When welding at low current the electrode can be ground to a point. At higher current a small flat on the end of the electrode is preferable as this helps with arc stability.

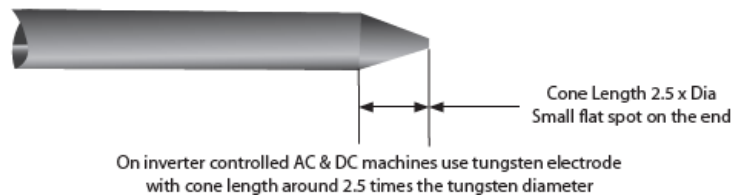

Electrode grinding

It is important when grinding the electrode to take all necessary precautions such as wearing eye protection and ensuring adequate protection against breathing in any grinding dust.

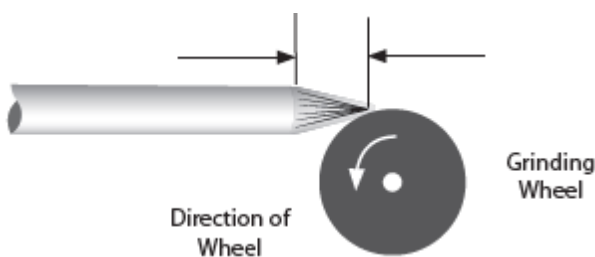

Tungsten electrodes should always be ground lengthwise (as shown) and not in a radial operation. Electrodes ground in a radial operation tend to contribute to arc wander due to the arc transfer from the grinding pattern. Always use a grinder solely for grinding electrodes to avoid contamination.

GUIDE TO TIG WELDING



Before starting any welding activity ensure that you have suitable eye protection and protective clothing. Also take the necessary steps to protect any persons within the welding area.

TIG welding consumables

The consumables of the TIG welding process are filler wires and shield gas.

Filler wires

Filler wires come in many different material types and usually as cut lengths, unless some automated feeding is required where it will be in reel form. Filler wire is generally fed in by hand. Always consult the manufacturer's data and welding requirements.

Filler Wire Diameter	DC Current Range (Amps)
1.0mm	20-90
2.4mm	65-115
3.2mm	100-165
4.8mm	200-350

Filler Wire Selection Guide

Gases

Shielding gas is required when welding to keep the weld pool free of oxygen. Whether you are welding mild steel or stainless steel the most commonly used shielding gas used in TIG welding is argon, for more specialised applications an argon helium mix or pure helium maybe used.

TIG welding - arc starting

The TIG process can use both non contact and contact methods to provide arc starting. Depending on the Jasic model, the options are indicated on a selector switch on the front control panel of the power source. The most common method of arc starting is 'HF' start. This term is often used for a variety of starting methods and covers many different types of start.

Arc starting - scratch start

This system is where the electrode is scratched along the work piece like striking a match. This is a basic way of turning any DC stick welder into a TIG welder without much work. It is not considered suitable for high integrity welding due to the fact that the tungsten can be melted on the work piece thereby contaminating the weld.

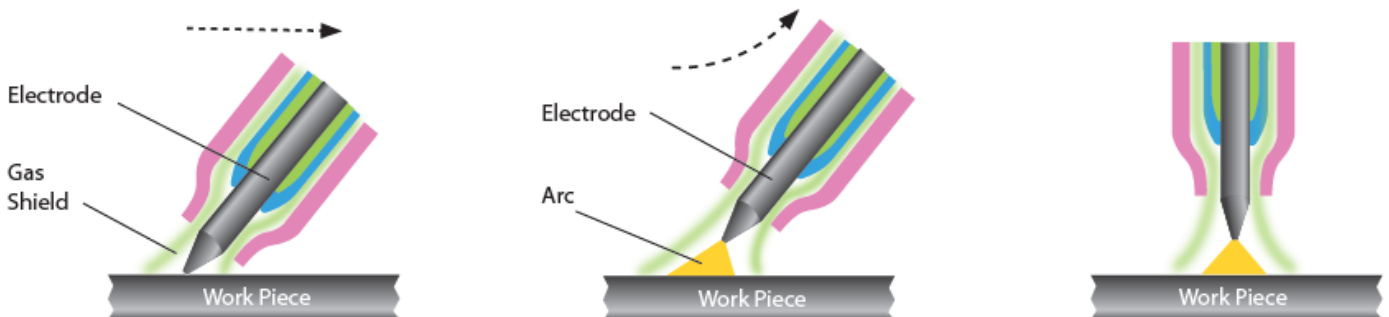

The main challenge with scratch start TIG welding is keeping your electrode clean. While a quick strike with the electrode on the metal is essential and then not lifting it more than 3mm away to create the arc will help, you also need to ensure your metal is completely clean.

GUIDE TO TIG WELDING



Before starting any welding activity ensure that you have suitable eye protection and protective clothing. Also take the necessary steps to protect any persons within the welding area.

Arc starting - lift TIG (lift arc)

Not to be confused with scratch start, this arc starting method allows the tungsten to be in direct contact with the work piece first but with minimal current so as not to leave a tungsten deposit when the tungsten is lifted and an arc is established.

With lift TIG start the open circuit voltage (OCV) of the welder folds back to a very low voltage output when the unit senses it has made continuity with the work piece. Once the torch is lifted the unit increases output as the tungsten leaves the surface. This creates little contamination and preserves the point on the tungsten although this is still not a 100% clean process. The tungsten still can get contaminated but lift TIG is still a much better option than scratch starting, for mild and stainless steel although these methods of arc starting are not a good option when welding aluminium.

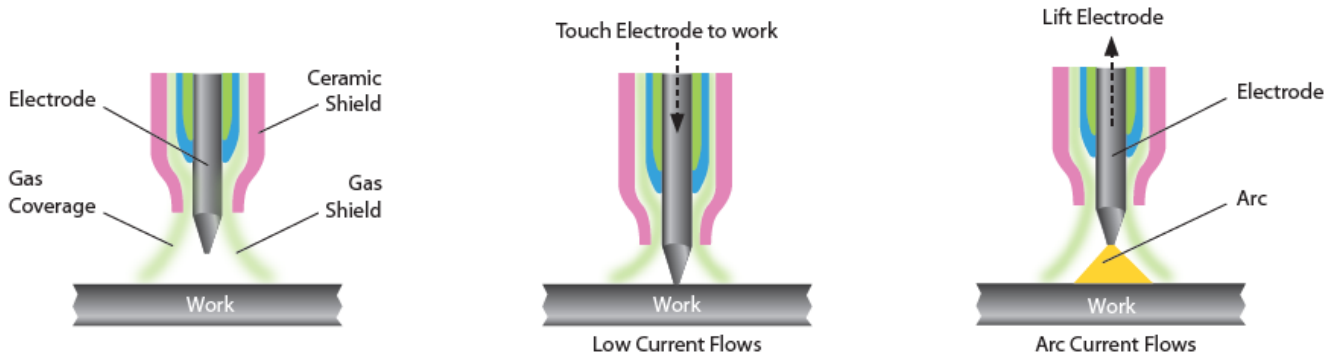

Arc starting - HF start

Non contact High Frequency (HF) start method is a high voltage and low amperage generated using a spark gap assembly and is the most popular and generally considered best TIG arc starting method. The High Frequency (HF) start generates a high frequency arc that ionizes the gas bridging the gap between the tungsten point and the work piece. This touch-less method creates almost no contamination unless the tungsten has been over sharpened or the start amperage is too high. It is an excellent choice for all material being welded especially aluminium although unless you need to weld aluminium, you don't have to use HF start steel/stainless.

The HF frequency varies with the spark gap and can be around 16000 Hz to 100000 Hz depending on spark gap width so consideration should be given with this method as it can cause electrical interference to nearby electrical equipment such as computers, CNC controls and phone systems.

If the spark gap is widened, the HF can become erratic.



TIG TORCH SPARE PARTS LIST



TIG Welding Torch Water Cooled - Model TIG83

Rating 350A DC, 260A AC @ 100% Duty Cycle EN60974-7 • 0.5mm to 4.0mm Electrodes

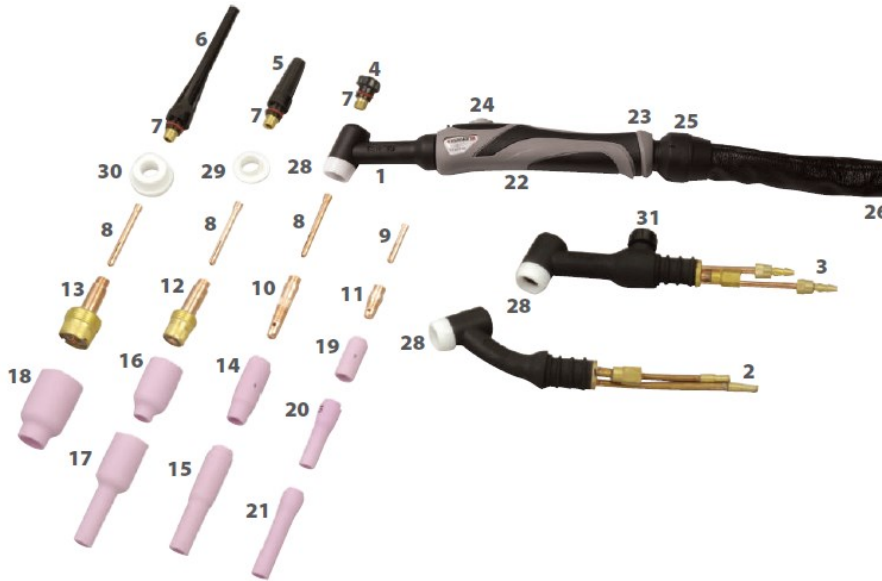

Main Consumables

Code	Description	Pack Qty
1	WP18 Rigid Torch Body	1
2	WP18F Flexible Torch Body	1
3	WP18V Torch Body c/w Argon Valve	1
4	57Y04 Short Back Cap	1
5	300M Medium Back Cap	1
6	57Y02 Long Back Cap	1
7	96W18 Back Cap O' Ring	10

Collets

Code	Description	Pack Qty
8	10N21 Standard .020" (0.5mm)	5
	10N22 Standard .040" (1.0mm)	5
	10N23 Standard 1/16" (1.6mm)	5
	10N26 Standard 5/64" (2.0mm)	5
	10N24 Standard 3/32" (2.4mm)	5
	10N25 Standard 1/8" (3.2mm)	5
	54N20 Standard 5/32" (4.0mm)	5
9	10N21S Stubby .020" (0.5mm)	5
	10N22S Stubby .040" (1.0mm)	5
	10N23S Stubby 1/16" (1.6mm)	5
	10N24S Stubby 3/32" (2.4mm)	5
	10N25S Stubby 1/8" (3.2mm)	5

Collet Bodies

Code	Description	Pack Qty
10	10N29 Standard .020" (0.5mm)	5
	10N30 Standard .040" (1.0mm)	5
	10N31 Standard 1/16" (1.6mm)	5
	10N31M Standard 5/64" (2.0mm)	5
	10N32 Standard 3/32" (2.4mm)	5
	10N28 Standard 1/8" (3.2mm)	5
	406488 Standard 5/32" (4.0mm)	5
11	17CB20 Stubby .020" - 1/8" (0.5 - 3.2mm)	5

Gas Lens Bodies

Code	Description	Pack Qty
12	45V29 Standard .020" (0.5mm)	1
	45V24 Standard .040" (1.0mm)	1
	45V25 Standard 1/16" (1.6mm)	1
	45V25M Standard 5/64" (2.0mm)	1
	45V26 Standard 3/32" (2.4mm)	1
	45V27 Standard 1/8" (3.2mm)	1
	45V28 Standard 5/32" (4.0mm)	1
13	45V0204 Large Dia .020"-.040" (0.5 - 1.0mm)	1
	45V116 Large Dia 1/16" (1.6mm)	1
	45V64 Large Dia 3/32" (2.4mm)	1
	995795 Large Dia 1/8" (3.2mm)	1
	45V63 Large Dia 5/32" (4.0mm)	1

Ceramic Cups

Code	Description	Pack Qty
14	10N50 Standard Cup 1/4" Bore	10
	10N49 Standard Cup 5/16" Bore	10
	10N48 Standard Cup 3/8" Bore	10
	10N47 Standard Cup 7/16" Bore	10
	10N46 Standard Cup 1/2" Bore	10
	10N45 Standard Cup 5/8" Bore	10
	10N44 Standard Cup 3/4" Bore	10
15	10N50L Long Cup 1/4" Bore	10
	10N49L Long Cup 5/16" Bore	10
	10N48L Long Cup 3/8" Bore	10
	10N47L Long Cup 7/16" Bore	10

Gas Lens Cups

Code	Description	Pack Qty
16	54N18 Standard Cup 1/4" Bore	10
	54N17 Standard Cup 5/16" Bore	10
	54N16 Standard Cup 3/8" Bore	10
	54N15 Standard Cup 7/16" Bore	10
	54N14 Standard Cup 1/2" Bore	10
	54N19 Standard Cup 11/16" Bore	10
17	54N17L Long Cup 5/16" Bore	10
	54N16L Long Cup 3/8" Bore	10
	54N15L Long Cup 7/16" Bore	10
	54N14L Long Cup 1/2" Bore	10
18	57N75 Large Dia Cup 3/8" Bore	5
	57N74 Large Dia Cup 1/2" Bore	5
	53N88 Large Dia Cup 5/8" Bore	5
	53N87 Large Dia Cup 3/4" Bore	5

Ceramic Cups for use with item 11

Code	Description	Pack Qty
19	13N08 Standard Cup 1/4" Bore	10
	13N09 Standard Cup 5/16" Bore	10
	13N10 Standard Cup 3/8" Bore	10
	13N11 Standard Cup 7/16" Bore	10
	13N12 Standard Cup 1/2" Bore	10
	13N13 Standard Cup 5/8" Bore	10
20	796F70 Long Cup 3/16" Bore	10
	796F71 Long Cup 1/4" Bore	10
	796F72 Long Cup 5/16" Bore	10
	796F73 Long Cup 3/8" Bore	10
21	796F74 X - Long Cup 3/16" Bore	10
	796F75 X - Long Cup 1/4" Bore	10
	796F76 X - Long Cup 5/16" Bore	10
	796F77 X - Long Cup 3/8" Bore	10

Secondary Consumables

Code	Description	Pack Qty
22	SP9110 LH & RH Handle Shell	1
23	SP9111 Handle Screw	1
24	SP9120 Single Button Switch	1
	SP9121 2 Button Switch	1
	SP9122 5K Potentiometer Switch	1
	SP9123 10K Potentiometer Switch	1
	SP9128 47K Potentiometer Switch	1
	SP9129 4 Button Switch	1
25	SP9114 Handle Ball Joint	1
26	SP9117 Leather Cover 800mm	1
27	SP9119 Cable Cover Joint (not illustrated)	1
28	18CG Standard Heat Shield	1
29	54N01 Gas Lens Heat Shield	1
30	54N63 Large Gas Lens Insulator	1
31	VS-1 Valve Stem WP18V	1
32	40V64 Power Cable Assy 12.5ft - 3/8" Bsp	1
	41V29 Power Cable Assy 25ft - 3/8" Bsp	1
33	45V07 Argon Hose Assy 12.5ft - 3/8" Bsp	1
	45V08 Argon Hose Assy 25ft - 3/8" Bsp	1
34	40V74 Water Hose Assy 12.5ft - 3/8" Bsp	1
	41V32 Water Hose Assy 25ft - 3/8" Bsp	1
35	0315071 Insulation Boot	5
36	6091 Neoprene Protective Cover	1m
37	SP9126 4m Switch Cable c/w 5 Pin Receptacle	1
	SP9127 8m Switch Cable c/w 5 Pin Receptacle	1

TIG WELDING PROBLEMS



Before starting any welding activity ensure that you have suitable eye protection and protective clothing. Also take the necessary steps to protect any persons within the welding area.

TIG welding defects and prevention methods

<u>Defect</u>	<u>Possible cause</u>	<u>Action</u>
Excessive tungsten use	Set up for DCEP	Change to DCEN
	Insufficient shield gas flow	Check for gas restriction and correct flow rates. Check for drafts in the weld area.
	Electrode size too small	Select correct size
	Electrode contamination during cooling time	Extend post flow gas time
Porosity/weld contamination	Loose torch or hose fitting	Check and tighten all fittings
	Inadequate shield gas flow	Adjust flow rate - normally 8-12L/m
	Incorrect shield gas	Use correct shield gas
	Gas hose damaged	Check and repair any damaged hoses
	Base material contaminated	Clean material properly
	Incorrect filler material	Check correct filler wire for grade of use
No operation when torch switch is operated	Torch switch or cable faulty	Check the torch switch continuity and repair or replace as required
	ON/OFF switch turned off	Check position of ON/OFF switch
	Mains fuses blown	Check fuses and replace as required
	Fault inside the machine	Call for a repair technician
Low output current	Loose or defective work clamp	Tighten/replace clamp
	Loose cable plug	Check and tighten all plugs
	Power source faulty	Call a repair technician
High frequency will not strike the arc	Weld/power cable open circuit	Check all cables and connections for continuity, especially the torch cables
	No shield gas flowing	Check cylinder contents, regulator and valves, also check the power source
Unstable arc when welding in DC	Tungsten contaminated	Break off contaminated end and regrind the tungsten
	Arc length incorrect	Arc length should be between 3-6mm
	Material contaminated	Clean all base and filler material
	Electrode connected to the wrong polarity	Reconnect to correct polarity
Arc is difficult to start	Incorrect tungsten type	Check and fit correct tungsten
	Incorrect shield gas	Use argon shield gas

TIG WELDING PROBLEMS



Before starting any welding activity ensure that you have suitable eye protection and protective clothing. Also take the necessary steps to protect any persons within the welding area.

TIG welding defects and prevention methods

<u>Defect</u>	<u>Possible cause</u>	<u>Action</u>
Excessive bead build up, poor penetration or poor fusion at the edges of the weld	Weld current too low	Increase the welding amperage Poor material prep
Weld bead flat and too wide or undercut at the weld edge or burning through	Weld current too high	Decrease the welding amperage
Weld bead too small or insufficient penetration	Welding travel speed too fast	Reduce your welding travel speed
Weld bead too wide or excessive bead build up	Welding travel speed too slow	Increase your welding travel speed
Uneven leg length in fillet joint	Wrong placement of filler rod	Re-position filler rod
Tungsten melts or oxidises when welding arc is made	TIG torch lead connected to + Little or no gas flow to weld pool Gas cylinder or hoses contain impurities The tungsten is too small for the weld current TIG/MMA selector set to MMA	Connect to - polarity Check gas apparatus as well as torch and hoses for breaks or restrictions Change gas cylinder and blow out torch and gas hoses Increase the size of the tungsten Ensure you have the power source set to TIG function

MAINTENANCE



The following operation requires sufficient professional knowledge on electric aspects and comprehensive safety knowledge. Make sure the input cable of the machine is disconnected from the electricity supply and wait for 5 minutes before removing the machine covers.

In order to guarantee that the arc welding machine works efficiently and in safety, it must be maintained regularly. Operators should understand the maintenance methods and means of arc welding machine operation. This guide should enable customers to carry out simple examination and safeguarding by oneself, try to reduce the fault rate and repair times of the arc welding machine, so as to lengthen service life of arc welding machines.

Period

Maintenance item

Daily examination	<ul style="list-style-type: none"> • Check the condition of the machine, mains cables, welding cables and connections. • Check for any warnings LEDs and machine operation. <p>Any repair work required, should always be carried out by a suitably qualified competent person.</p>
Monthly examination	<ul style="list-style-type: none"> • Disconnect from the mains supply and wait for at least 5 minutes before removing the cover. • Check internal connections and tighten if required. • Clean the inside of the machine with a soft brush and vacuum cleaner. • Take care not to remove any cables or cause damage to components. • Ensure that ventilation grills are clear. • Carefully replace the covers and test the unit. <p>This work should be carried out by a suitably qualified competent person.</p>
Yearly examination	<ul style="list-style-type: none"> • Carry out an annual service to include safety check in accordance with the manufacturers standard (EN 60974-1). <p>This work should be carried out by a suitably qualified competent person.</p>

⇒ Ensure the power is disconnected before working on the machine.

⇒ Always wait 5 minutes after power switch off before opening the case.

Please Note:

Check these power connections daily to ensure they have not become loose otherwise arcing may occur when used under load.

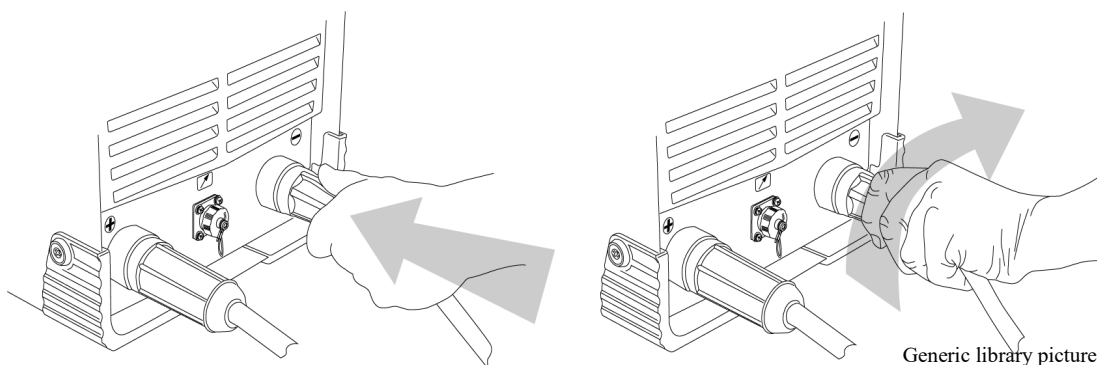

ERROR CODES



The following operation requires sufficient professional knowledge on electric aspects and comprehensive safety knowledge. Make sure the input cable of the machine is disconnected from the electricity supply and wait for 5 minutes before removing the machine covers.

ERROR CODES

An error code is displayed on the digital meter when a problem occurs with the machine.

Error Code	Error code description	Possible cause	Remedy
E-0	Over current on input	Long welding arc Low input mains supply, should be 400V +/-10%	Reduce welding arc length Have a technician check the mains input voltages
E-3	Over heating error	Machine has exceeded its duty cycle Fan not working Air vent blocked	Allow machine to cool down Check fan function Check and unblock vents
E-5	Water cooling error	Water cooler turned off No water flow detected	Check the water cooler is turned on and running Check for restrictions or blockages

SERVICE SCHEDULE RECORD

Please use the table below to record all service and maintenance work carried out on your product.

Date	Type of service and work carried out	Serviced by	Due date for next check

TROUBLESHOOTING



The following operation requires sufficient professional knowledge on electric aspects and comprehensive safety knowledge. Make sure the input cable of the machine is disconnected from the electricity supply and wait for 5 minutes before removing the machine covers.

Before arc welding machines are dispatched from the factory, they have already been checked thoroughly. The machine should not be tampered with or altered. Maintenance must be carried out carefully. If any wire becomes loose or is misplaced, it maybe potentially dangerous to the user!

Only professional maintenance personnel should repair the machine!

Description of fault	Possible cause
The power LED is OFF and the fan is not functioning	The primary supply voltage has not been switched ON or input fuse has blown The welding power source input switch is switched OFF Loose connections internally
The fault LED is ON and the fan is running	The machine is under over-heating protection status. It can recover automatically after the welding machine is cooled Check incoming mains supply to ensure its within 400V +/- 15%
No high frequency is produced	Process selection switch is set to manual metal arc (MMA) Torch trigger switch lead is disconnected or switch/lead is faulty High frequency spark gap too wide or short circuited
Welding current reduces when welding	Poor work lead connection to the work piece
TIG electrode melts when arc is struck	TIG torch is connected to the (+) VE terminal
No gas flow when the TIG torch trigger switch is depressed	Empty gas cylinder Gas regulator is turned off Gas hose is blocked or cut Torch trigger switch lead is disconnected or switch/lead is faulty
Difficult to ignite the arc	The arc ignition current is too low or the arc ignition time is too short
The electrode holder becomes very hot	The rated current of the electrode holder is smaller than its actual working current, replace it with a higher rated current capacity
Excessive spatter in MMA welding	The output polarity connection is incorrect, exchange the polarity
Other malfunction	Contact your supplier

- Ensure the power is disconnected before working on the machine.
- Always wait 5 minutes after power switch off before opening the case.

WEEE disposal

The equipment is manufactured with materials which do not contain any toxic or poisonous materials dangerous to the operator.

When the equipment is scrapped, it should be dismantled separating components according to the type of materials.

Do not dispose of the equipment with normal waste. The European Directive 2002/96/EC and United Kingdom's Directive The Waste Electrical and Electronic Equipment (WEEE) regulations 2013 states that electrical equipment that has reached its end of life must be collected separately and returned to an environmentally compatible recycling facility.

Jasic has a relevant recycling system which is compliant and registered in the UK with the environment agency. Our registration reference is WEEMM3813AA.

In order to comply with WEEE regulations outside the UK you should contact your supplier.

RoHS Compliance Declaration

We herewith confirm, that the above mentioned product does not contain any of the restricted substances as listed in EU Directive 2011/65/EU and the UK directive ROHS Regulations 2012 in concentrations above the limits as specified therein.

UKCA Declaration of Conformity

The manufacturer, or its legal representative Wilkinson Star Limited, declares that the equipment described below is designed and produced according to following UK legislation:

- Electrical equipment safety 2016
- Electromagnetic compatibility (EMC) regulations 2016
- The restrictions of the use of certain hazardous substances in electrical and electronic equipment regulations 2012

And inspected according to following designated standards:

- EN 60 974-1:2018+A1:2019
- EN 60 974-10:2014+A1:2015

Any alteration or change to these machines by any unauthorized person makes this declaration invalid.

Model:

JT-400P

Authorised Representative:

Wilkinson Star Limited
Shield Drive
Wardley Industrial Estate
Worsley
Manchester
M28 2WD

Disclaimer:

Please note that this confirmation is given to the best of our present knowledge and belief. Nothing herein represents and/or may be interpreted as warranty within the meaning of the applicable warranty law.

EC Declaration of Conformity

EC DECLARATION OF CONFORMITY

The manufacturer, or its legal representative **Wilkinson Star Limited**, declares that the equipment described below is designed and produced according to following EU Directives:

- Low Voltage Directive (LVD), No.: 2014/35/EU
- Electromagnetic compatibility (EMC) Directive, No.: 2014/30/EU

And inspected according to following

EU - Norms:

- EN 60 974-1:2012
- EN 60 974-10:2014+A1

Any alteration or change to these machines by any unauthorized person makes this Declaration invalid.

Wilkinson Star model
JT-400P

Jasic Model
TIG 400P (W322)

Authorised Representative

Wilkinson Star Limited
Shield Drive, Wardley Industrial Estate,
Worsley, Manchester M28 2WD
Tel 0161 793 8127

Signature

Dr John A Wilkinson OBE

Position Chairman

Manufacturer

Shenzhen Jasic Technology Co LTD
Np3 Qinglan, 1st Road
Pingshan District
Shenzhen, China

Signature

Shenzhen Jasic Technology Co LTD

Position

Date



Company stamp

Date

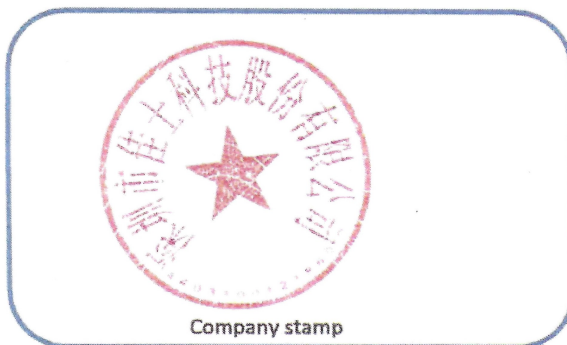

Company stamp

STATEMENT OF WARRANTY

All new JASIC welders, plasma cutters and multi-process units sold through our partner Wilkinson Star Limited within the United Kingdom and Ireland shall be warranted to the original owner, non transferable, against failure due to defective materials or production. The warranty period is 5 years following the date of purchase. We recommend you register your product within 28 days of purchase. The original invoice is documentation for the standard warranty period. The warranty period is based on a single shift pattern.

Defective units shall be repaired or replaced by the company at our workshop. The company may opt to refund the purchase price (less any costs and depreciation due to use and wear). The company reserves the right to alter the warranty conditions at any time with effect for the future.

A prerequisite for the full warranty is that products are operated in accordance with the operating instructions supplied, observing the relevant installation and any legal requirements recommendations and guidelines and carrying out the maintenance instructions shown in the operator manual. This should be carried out by a suitably qualified competent person.

In the unlikely event of a problem, this should be reported to Jasic technical support team to review the claim.

The customer has no claim to loan or replacement products whilst repairs are being performed.

The following falls outside the scope of the warranty:

- Defects due to natural wear and tear
- Failure to observe the operating and maintenance instructions
- Connection to an incorrect or faulty mains supply
- Overloading during use
- Any modifications that are made to the product without the prior written consent
- Software errors due incorrect operation
- Any repairs that are carried out using non-approved spare parts
- Any transport or storage damage
- Direct or indirect damage as well as any loss of earnings are not covered under the warranty
- External damage such as fire or damage due to natural causes e.g. flooding

NOTE: Under the terms of the warranty, welding torches, their consumable parts, wire feed unit drive rolls and guide tubes, work return cables and clamps, electrode holders, connection and extension cables, mains and control leads, plugs, wheels, coolant etc. are covered with a 3 month warranty.

Jasic shall in no event be responsible for any third party expenses or expenses/costs or any indirect or consequential expenses/costs.

Jasic will submit an invoice for any repair work performed outside the scope of the warranty. A quotation for any non warranty will be raised prior to any repairs being carried out.

The decision about repair or replacement of the defective part(s) is made by Jasic. The replaced part(s) remain(s) Jasic property.

Warranty extends only to the machine, its accessories and parts contained inside. No other warranty is expressed or implied. No warranty is expressed or implied in regards to the fitness of the product for any particular application or use.

For further information on Jasic product warranty terms and product warranty registration please visit:

www.jasic-warranty.co.uk/terms

www.jasic-warranty.co.uk

OPTIONS AND ACCESSORIES

Part Number	Description
---	TIG torch options for JT-400P water cooled package
TIG-83ERGO	Titanium 18 TIG Torch 12.5ft c/w Adaptor + Jasic 9 Plug
TIG-83ERGO-FLEXI	Titanium 18 Flexi TIG Torch 12.5ft c/w Adaptor + Jasic 9 Plug
TIG-83-8MERGO	Titanium 18 TIG Torch 25ft c/w Swivel Dinse + Jasic 9 Plug
TIG-83F-8MERGO	Titanium 18F TIG Torch 25ft c/w Swivel Dinse + Jasic 9 Plug
---	TIG torch options for JT-400P air cooled package
TIG-82	WP26 TIG Torch 12.5ft c/w Dinse Adaptor + Jasic 9 Plug
TIG-82-8M	WP26 TIG Torch 25ft c/w Dinse Adaptor + Jasic 9 Plug
Part Number	Description
JSG-PLUG-9PIN	TIG Torch Plug (9 Pin)
JSG-PLUG-9PIN	Foot Pedal Plug (9 Pin)
WCS50-5	Welding Cable Set (MMA) 5m (50mm Cable)
WC-5-05	Electrode Holder and Lead 5m
EC-5-05	Work Return Lead and Clamp 5m (50mm Cable)
CP5070	Cable Plug 50-70mm
SSARG1GPS	Single Stage 1 Gauge Argon Pre Set Regulator
FLOW14	0-14LPM Flowmeter
JFC-09	Remote Foot Control
JH-HDX	Jasic HD True Colour Auto Darkening Welding Helmet



JH-HDX
Jasic Auto Darkening HD
Welding Helmet with True
Colour Technology



JFC-07
Jasic Remote Foot Control

Wilkinson Star Limited

Shield Drive

Wardley Industrial Estate

Worsley

Manchester

UK

M28 2WD

+44 (0)161 793 8127



www.jasic.co.uk

November 2022 - Issue 8