

A close-up photograph of several orange plastic carver clamps. The clamps are arranged in a way that shows their curved, ergonomic shape and the textured grip areas. The lighting is bright, highlighting the smooth plastic surface and the intricate details of the tool's design.

CARVER CLAMPS

PRODUCT RANGE



CARVER CLAMPS



FOR OVER 50 YEARS CARVER & CO. (ENGINEERS) LIMITED HAS MANUFACTURED THE UK'S LEADING RANGE FOR TRUSTED, DURABLE CLAMPS FOR USE IN THE WELDING, FABRICATION AND ENGINEERING SECTORS – CARVER CLAMPS.

With a wide range of options to suit every work-holding solution, all designed to withstand the rigours of heavy industrial use, our clamps are renowned worldwide.

The Carver Clamps name is synonymous with quality, well designed products fit for the job in hand.

The complete Carver Clamps range includes Rack and Bar Clamps, T-Slot and Buttress Clamps as well as Machine Vices.



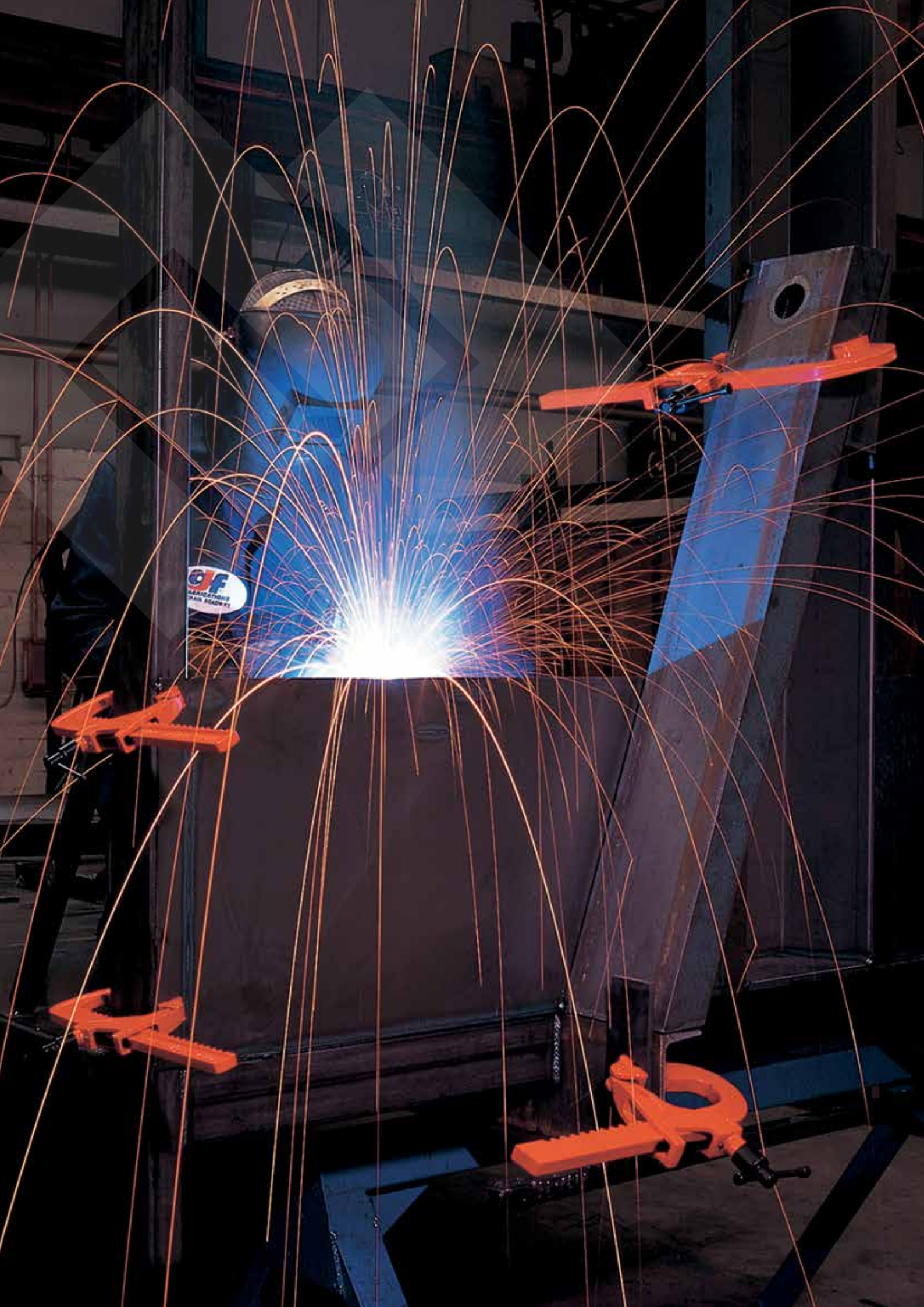

CONTENTS

 RACK CLAMPS	01
 BAR CLAMPS	02
 T-SLOT CLAMPS	03
 BUTTRESS CLAMPS	04
 MACHINE CLAMPS	05
 MULTICLAMP	06
 SPARE PARTS	07

CARVER CLAMPS



RACK CLAMPS

Designed to cope with the toughest of engineering requirements the Carver Rack Clamp is widely used in fabrication, welding and maintenance. In fact, it is a vital addition to any toolroom or maintenance department.





With a length capacity of 0-1350mm (54") the Rack Clamp is available in standard, medium and heavy-duty specification. Throat depth variations are also available across the standard and medium duty formats.

Its features include a unique anti-spatter shield to prevent the clamp-adjusting screw from weld spatter damage. The clamp's spring-loaded jaw stays in position when pressure is removed, yet the design still allows the jaw to move to securely clamp angled surfaces. Aside to this any tightening actions will not rotate the workpiece giving you complete control.





RACK CLAMPS

	Part No.	Model No.	Alternative Model No.	Capacity (S) mm (Inch)	Reach (B1) mm (Inch)	Overall Length mm (Inch)	Weight kg
Standard Duty 1130 daN 	C301003	T186-6	T186-150	150 (6)	60 (2.3/8)	245 (9.5/8)	1.4
	C301005	T186-12	T186-300	300 (12)	60 (2.3/8)	395 (15.1/2)	1.8
	C301009	T186-20	T186-500	500 (20)	60 (2.3/8)	640 (25.1/8)	2.5
	C301012	T186-30	T186-750	750 (30)	60 (2.3/8)	890 (35.1/8)	3.2
Standard Duty Long Reach 565 daN 	C301101	T321-10	T321-250	250 (10)	120 (4.3/4)	360 (14.1/8)	2.0
	C301313	T321-24	T321-600	600 (24)	120 (4.3/4)	715 (28.1/8)	3.5
Medium Duty 1800 daN 	C301046	T290-9	T290-225	225 (9)	90 (3.1/2)	420 (16.1/2)	5.5
	C301049	T290-18	T290-450	450 (18)	90 (3.1/2)	655 (25.3/4)	7.0
	C301052	T290-30	T290-750	750 (30)	90 (3.1/2)	959 (37.3/4)	8.5
	C301055	T290-40	T290-1000	1000 (40)	90 (3.1/2)	1216 (47.7/8)	10.5
Medium Duty Long Reach 900 daN 	C301035	T285-9	T285-225	225 (9)	200 (8)	420 (16.1/2)	7.1
	C301037	T285-18	T285-450	450 (18)	200 (8)	655 (25.3/4)	8.5
	C301039	T285-30	T285-750	750 (30)	200 (8)	959 (37.3/4)	10.0
	C301041	T285-40	T285-1000	1000 (40)	200 (8)	1216 (47.7/8)	11.5
Heavy Duty 2700 daN 	C301172	T257-6	T257-150	150 (6)	115 (4.1/2)	403 (15.7/8)	9.8
	C301173	T257-12	T257-300	300 (12)	115 (4.1/2)	555 (21.7/8)	10.9
	C301174	T257-18	T257-450	450 (18)	115 (4.1/2)	710 (27.3/4)	12.2
	C301175	T257-24	T257-600	600 (24)	115 (4.1/2)	850 (33.1/2)	13.1
	C301176	T257-36	T257-900	900 (36)	115 (4.1/2)	1165 (45.3/4)	15.8
	C301177	T257-54	T257-1350	1350 (54)	115 (4.1/2)	1615 (63.1/2)	19.1

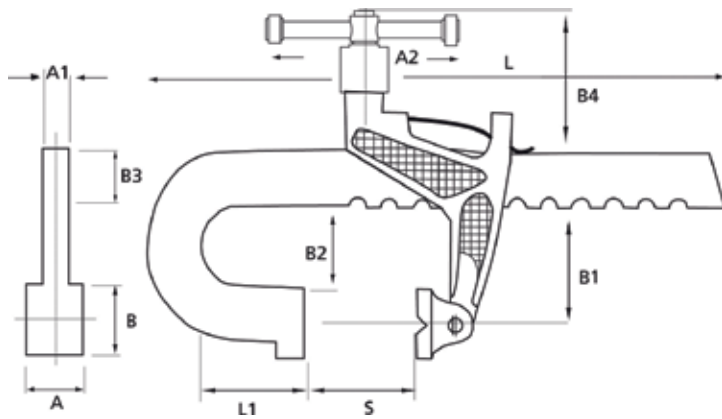

1 daN=1kgf / 1 daN=2.2lbf / 1 daN=10 N

FOR TOUGH JOBS IN ENGINEERING INCLUDING:

- ✦ Fabrication
- ✦ Welding
- ✦ Machining
- ✦ Maintenance
- ✦ Toolroom

Model No.	A mm	A1 mm	A2 mm	B mm	B2 mm	B3 mm	B4 mm	L mm	L1 mm
T186-6	25	13	76	32	43	33	76	245	20
T186-12	25	13	76	32	43	33	76	395	20
T186-20	25	13	76	32	43	30	76	680	80
T186-30	25	13	76	32	43	30	76	930	80
T321-10	25	13	76	35	102	33.5	76	360	25
T321-24	25	13	76	32	98	30	76	715	8
T290-9	40	20	140	60	65	40	105	420	75
T290-18	40	20	140	60	65	40	105	640	75
T290-30	40	20	140	60	65	40	105	930	75
T290-40	40	20	140	60	65	40	105	1200	75
T285-9	40	20	140	60	180	40	105	430	75
T285-18	40	20	140	60	180	40	105	655	75
T285-30	40	20	140	60	180	40	105	955	75
T285-40	40	20	140	60	180	40	105	1205	75
T257-6	51	22	187	60	85	51	127	403	100
T257-12	51	22	187	60	85	51	127	555	100
T257-18	51	22	187	60	85	51	127	710	100
T257-24	51	22	187	60	85	51	127	850	100
T257-36	51	22	187	60	85	51	127	1165	100
T257-54	51	22	187	60	85	51	127	1635	100



BAR CLAMPS

With its simple reverse jaws for a spreading action the Carver Bar Clamp has unsurpassed holding power. As with our Rack Clamps the spring-loaded jaw stays in position when pressure is removed and yet the jaw moves to securely clamp angled surfaces.

The Bar Clamp's design ensures that:



- ❖ Working parts are not exposed to weld spatter
- ❖ No long screws to bend
- ❖ Any tightening action will not rotate the workpiece

With a length capacity of 0-2700mm (108") the Bar Clamp is available in standard, medium and heavy-duty specification. Throat depth variations are also available across the standard and medium duty formats.

The Bar Clamp also supports a series of optional extras including bar connecting boxes for when you need to create extra length for the standard and medium duty formats.





	Part No.	Model No.	Alternative Model No.	Capacity (S) mm (Inch)	Reach (B1) mm (Inch)	Weight kg
Standard Duty 1130 daN 	C301179	T186-24	T186-600	600 (24)	60 (2.3/8)	3.4
	C301180	T186-36	T186-900	900 (36)	60 (2.3/8)	4.4
	C301182	T186-60	T186-1500	1500 (60)	60 (2.3/8)	5.8
	C301184	T186-84	T186-2100	2100 (84)	60 (2.3/8)	7.6
	C301185	T186-96	T186-2400	2400 (96)	60 (2.3/8)	8.8
Standard Duty Long Reach 565 daN 	C301187	T321-24	T321-600	600 (24)	120 (4.3/4)	3.5
	C301188	T321-36	T321-900	900 (36)	120 (4.3/4)	4.5
	C301190	T321-60	T321-1500	1500 (60)	120 (4.3/4)	5.9
	C301192	T321-84	T321-2100	2100 (84)	120 (4.3/4)	7.7
	C301193	T321-96	T321-2400	2400 (96)	120 (4.3/4)	8.9
Medium Duty 1800 daN 	C301195	T290-36	T290-900	900 (36)	90 (3.1/2)	10.5
	C301196	T290-48	T290-1200	1200 (48)	90 (3.1/2)	12.1
	C301197	T290-60	T290-1500	1500 (60)	90 (3.1/2)	14.0
	C301199	T290-84	T290-2100	2100 (84)	90 (3.1/2)	18.0
Medium Duty Long Reach 900 daN 	C301203	T285-36	T285-900	900 (36)	200 (8)	11.5
	C301204	T285-48	T285-1200	1200 (48)	200 (8)	13.0
	C301205	T285-60	T285-1500	1500 (60)	200 (8)	15.0
	C301207	T285-84	T285-2100	2100 (84)	200 (8)	19.0
Heavy Duty 2700 daN 	C301210	T257-84	T257-2100	2100 (84)	115 (4.1/2)	27.2
	C301212	T257-108	T257-2700	2700 (108)	115 (4.1/2)	32.0

BAR CLAMPS

**FOR TOUGH JOBS IN
ENGINEERING INCLUDING:**

- ✦ Fabrication
- ✦ Welding
- ✦ Machining
- ✦ Maintenance
- ✦ Toolroom

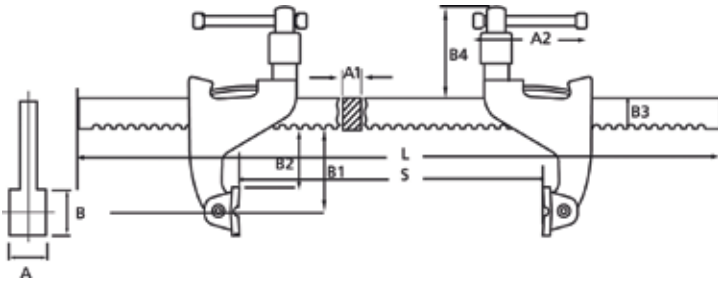

1 daN=1kgf / 1 daN=2.2lbf / 1 daN=10 N

Model No.	A mm	A1 mm	A2 mm	B mm	B2 mm	B3 mm	B4 mm	L mm
T186-24	25	12	76	32	44	30	76	710
T186-36	25	12	76	32	44	30	76	1020
T186-60	25	12	76	32	44	30	76	1625
T186-84	25	12	76	32	44	30	76	2235
T186-96	25	12	76	32	44	30	76	2540
T321-24	25	12	76	32	104	30	76	710
T321-36	25	12	76	32	104	30	76	1020
T321-60	25	12	76	32	104	30	76	1625
T321-84	25	12	76	32	104	30	76	2235
T321-96	25	12	76	32	104	30	76	2540
T290-36	38	20	140	51	65	40	105	1070
T290-48	38	20	140	51	65	40	105	1390
T290-60	38	20	140	51	65	40	105	1690
T290-84	38	20	140	51	65	40	105	2290
T285-36	38	20	140	51	180	40	105	1070
T285-48	38	20	140	51	180	40	105	1390
T285-60	38	20	140	51	180	40	105	1690
T285-84	38	20	140	51	180	40	105	2290
T257-84	51	22	187	63.5	83	52	127	2335
T257-108	51	22	187	63.5	83	52	127	2945



T-SLOT CLAMPS

The Carver T-Slot Clamp is a popular solution for drilling, grinding, machining and planing applications. The secure holding power and unique design of the T-Slot offers a quicker and safer solution than using packers and bolts, eliminating any loose pieces in the working space.

The T-Slot is highly flexible and can be used at any angle, with the head creating a 'push' action when reversed.

With a height capacity of 0 – 1500mm (60") the T-Slot is available in standard and heavy duty applications, as well as with a choice of standard and long reach variations.





T-SLOT CLAMPS

	Part No.	Model No.	Alternative Model No.	Clamping Height		Reach mm (Inch)	Weight kg
				min mm (Inch)	max mm (Inch)		
Standard Duty 2270 daN 	C301213	T400-4	T400-100	25 (1)	100 (4)	19 (3/4) OR with base reversed 35 (1.5/8)	2.3
	C301227	T400-6	T400-150	25 (1)	150 (6)		2.5
	C301228	T400-8	T400-200	62 (2.1/2)	200 (8)		2.6
Standard Duty Long Reach 1600 daN 	C301214	T600-4	T600-100	12 (1/2)	100 (4)	57 (2.1/4) OR with base reversed 73 (2.7/8)	2.7
	C301215	T600-6	T600-150	12 (1/2)	150 (6)		2.9
	C301216	T600-8	T600-200	50 (2)	200 (8)		3.0
Heavy Duty 3630 daN 	C301217	T402-6	T402-150	0 (0)	150 (6)	44 (1.3/4) OR with base reversed 66 (2.5/8)	6.3
	C301218	T402-12	T402-300	0 (0)	300 (12)		8.0
	C301219	T402-18	T402-450	150 (6)	450 (18)		8.8
	C301220	T402-24	T402-600	300 (12)	600 (24)		10.0
	C301221	T402-30	T402-750	450 (18)	750 (30)		11.7
	C301222	T402-36	T402-900	600 (24)	900 (36)		13.0
	C301223	T402-42	T402-1050	750 (30)	1050 (42)		14.5
	C301224	T402-48	T402-1200	900 (36)	1200 (48)		15.7
	C301225	T402-54	T402-1350	1050 (42)	1350 (54)		16.7
	C301226	T402-60	T402-1500	1200 (48)	1500 (60)		18.5
Heavy Duty 2500 daN 	C301229	T602-6	T602-150	0 (0)	150 (6)	95 (3.3/4) OR with base reversed 117 (4.3/8)	7.3
	C301230	T602-12	T602-300	0 (0)	300 (12)		9.0
	C301231	T602-18	T602-450	150 (6)	450 (18)		9.8
	C301232	T602-24	T602-600	300 (12)	600 (24)		11.0
	C301233	T602-30	T602-750	450 (18)	750 (30)		12.7
	C301234	T602-36	T602-900	600 (24)	900 (36)		14.0
	C301235	T602-42	T602-1050	750 (30)	1050 (42)		15.5
	C301236	T602-48	T602-1200	900 (36)	1200 (48)		16.7
	C301237	T602-54	T602-1350	1050 (42)	1350 (54)		17.7
	C301238	T602-60	T602-1500	1200 (48)	1500 (60)		19.5

T-SLOT CLAMPS

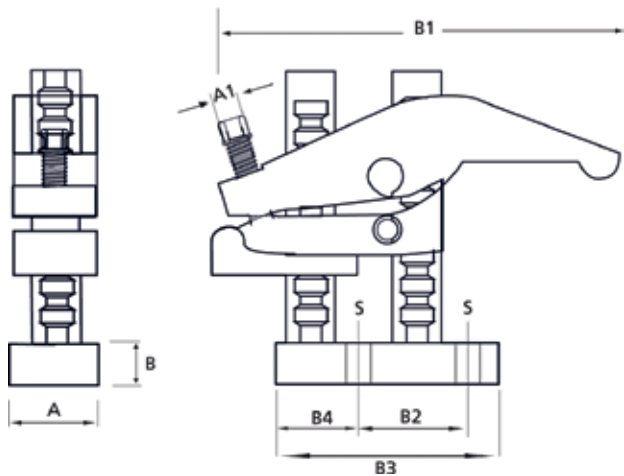

HOLDS WORK SECURELY ON MANY MACHINES INCLUDING:

- ◆ Horizontal and vertical boring machines
- ◆ Planners
- ◆ Millers
- ◆ Lathes
- ◆ Power Presses
- ◆ Radial Drills

1 daN=1kgf / 1 daN=2.2lbf / 1 daN=10 N

Model No.	A mm	A1 mm	B mm	B1 mm	B2 mm	B3 mm	B4 mm	S								
T400-4 T400-6 T400-8	51	13 A/F Hex	16	162	54	96.25	31.75	For M12 bolt								
T600-4 T600-6 T600-8									51	13 A/F Hex	16	200	54	96.25	31.75	For M12 bolt
T402-6 T402-12 T402-18 T402-24 T402-30 T402-36 T402-42 T402-48 T402-54 T402-60																
T602-6 T602-12 T602-18 T602-24 T602-30 T602-36 T602-42 T602-48 T602-54 T602-60	76	19 A/F Hex	19	308	71	140	54	For M16 bolt								



BUTTRESS CLAMPS

The Buttruss Clamp holds press tools on all types of power press and makes it a popular choice for drilling, grinding, machining, lathe faceplates and planing applications. It has the ability to clamp work from 0-75mm (3") deep.



One key feature is the self-aligning captive pivot which ensures a constant clamping ratio between workpiece and table, whilst its H-shaped heads four-point contact resists the tendency for the workpiece to rotate giving you added stability.

The Buttruss Clamp is available in three sizes – standard, medium and heavy Duty.





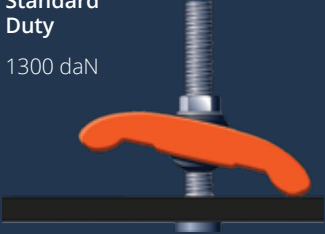
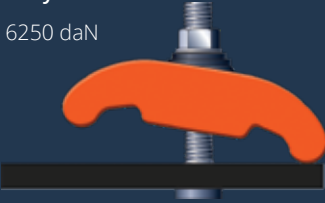

BUTTRESS CLAMPS

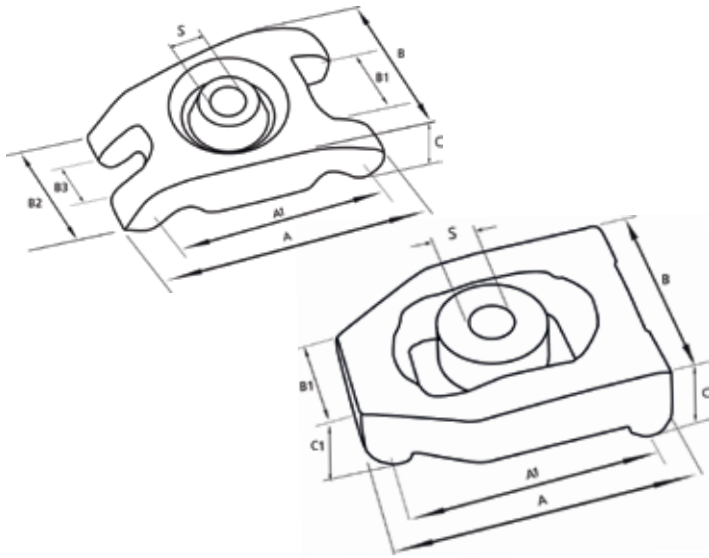
	Part No.	Model No.	Max Safe Working Height mm (Inch)	Max Fixing Bolt Diameter mm (Inch)	Clamp Weight kg
Standard Duty 1300 daN 	C301160	T614-0	25 (1)	M12 (1/2)	0.6
Medium Duty 6250 daN 	C301161	T614-1	57 (2.1/4)	M16 (5/8) or M20 (3/4)	2.7
Heavy Duty 8000 daN 	C301162	T614-2	75 (3)	M24 (1)	4.3



- ◆ Holds press tools on all types of power press.
- ◆ Clamps work up to 75mm (3") deep to drilling machines and lathe faceplates.
- ◆ Constant clamping force ratio between workpiece and table, thanks to self-aligning captive pivot.
- ◆ h-shaped head's 4-point contact resists tendency for workpiece to rotate.

1 daN=1kgf / 1 daN=2.2lbf / 1 daN=10 N

Model No.	A mm	A1 mm	A2 mm	B mm	B2 mm	B3 mm	C mm	C1 mm	S mm
T614-0 	110	90	66	36	40	20	26	-	13
T614-1 	160	134	100	53	65	29	46	-	21
T614-2 	170	148	130	65	-	-	50	40	26



MACHINE VICES

Carver Machine Vices effortlessly handle work where conventional vices cannot which makes them a perfect solution for drilling, grinding, machines and planing applications.

With its two-plane operation the vice's horizontal jaws tighten on work, while the vertical adjustment brings the work firmly down onto the machine table.



The vice's low profile gives maximum cutter access and this flexibility is further added to by the fact that the individual fixed and moving abutments offer infinite vice capacities.

The vice has a maximum horizontal clamping force of 45kg and is available as two solutions – low profile and heavy duty for those jobs which require greater clamping force. The heavy duty option also enables the full length of the machine bed to be used.





MACHINE VICES

	Part No.	Model No.	Horizontal Clamping Force daN	Downward Force daN	Jaw Height mm (inch)	Fixing Bolts mm (inch)	Weight kg
Low Profile Horizontal 2250 daN Vertical 900 daN 	C301150	T500	2250	900	27 (1.1/16)	M12 (1/2)	3.8
Heavy Duty Horizontal 4500 daN Vertical 1800 daN 	C301153	T550	4500	1800	70 (2.1/2)	M16 (5/8) OR M20 (3/4)	24

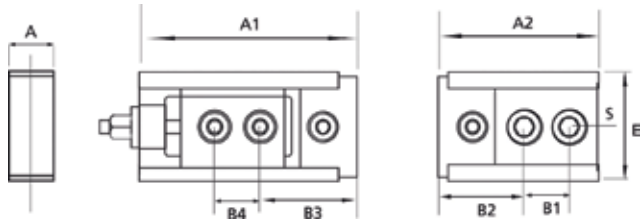

T500

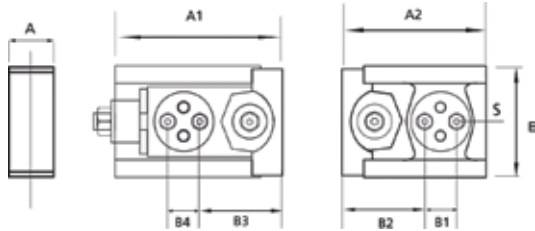



T550

1 daN=1kgf / 1 daN=2.2lbf / 1 daN=10 N

EFFORTLESSLY HANDLE WORK WHERE CONVENTIONAL VICES CANNOT:

- ◆ Milling
- ◆ Grinding
- ◆ General surface operations
- ◆ Operates on two planes:
 - ◆ Horizontal – jaws tighten on work
 - ◆ Vertical – bringing work firmly down onto machine table

Model No.	A mm	A1 mm	A2 mm	B mm	B1 mm	B2 mm	B3 MIN mm	B3 MAX mm	B4 mm	S HOLE mm
T500 	30	150	109	67	35	55	55	65	35	13
	77	245	195	151	57	93.5	89.5	114.5	57	16.2
T550 	77	245	195	151	53	95.5	91.5	116.5	53	20.2

CARVER CLAMPS

MULTICLAMP

The Multiclamp is a combination of three of the most popular Clamps in the Carver range. It includes the 150mm (6"), 250mm (10") and 300mm (12") Long Reach Clamps.

The Carver Multiclamp is a multi-functional unit with interchangeable heads all contained in a dedicated carry case for easy transportation and storage.





**FOR TOUGH JOBS
IN ENGINEERING INCLUDING:**

- ◆ Fabrication
- ◆ Welding
- ◆ Machining
- ◆ Maintenance
- ◆ Toolroom
- ◆ Clamping force:
 - ◆ Standard Reach: 8500 daN
 - ◆ Long Reach: 425 daN

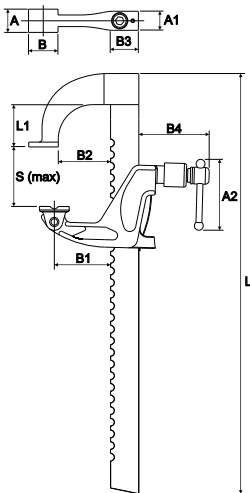

Configuration	S mm	A mm	A1 mm	A2 mm	B mm	B1 mm	B2 mm	B3 mm	B4 mm	L mm	L1 mm
STANDARD REACH	320	25	21.5	76	32	65	55	32	76	450	45
LONG REACH	320	25	21.5	76	32	65	55	32	76	450	45

WEIGHT CASE+ CLAMPS = 4.0KG SIZE: CASE 420MM X 370MM X 110MM

SPARE PARTS

We offer a full range of spare parts across the Carver Clamps product range.

These parts are available worldwide through our distributor network.

Part No.	Model No.	Alternate Model No.	Description
C301004	T186-6-1	T186-150-1	Standard Duty 150mm Jay
C301006	T186-12-1	T186-300-1	Standard Duty 300mm Jay
C301010	T186-20-1	T186-500-1	Standard Duty 500mm Jay
C301013	T186-30-1	T186-750-1	Standard Duty 750mm Jay
C301000	T186-2	-	Standard Duty Moveable Jaw
C301102	T312-10-1	T321-250-1	Standard Duty Long Reach 250mm Jay
C301316	T321-24-1	T321-600-1	Standard Duty Long Reach 600mm Jay
C301100	T321-2	-	Standard Duty Long Reach Moveable Jaw
C301047	T290-9-1	T290-225-1	Medium Duty 225mm Jay
C301050	T290-18-1	T290-450-1	Medium Duty 450mm Jay
C301053	T290-30-1	T290-750-1	Medium Duty 750mm Jay
C301056	T290-40-1	T290-1000-1	Medium Duty 1000mm Jay
C301043	T290-2	-	Medium Duty Moveable Jaw
C301036	T285-9-1	T285-225-1	Medium Duty Long Reach 225mm Jay
C301038	T285-18-1	T285-450-1	Medium Duty Long Reach 450mm Jay
C301040	T285-30-1	T285-750-1	Medium Duty Long Reach 750mm Jay
C301042	T285-40-1	T285-1000-1	Medium Duty Long Reach 1000mm Jay
C301034	T285-2	-	Medium Duty Long Reach Moveable Jaw
C301024	T257-6-1	T257-150-1	Heavy Duty 150mm Jay
C301025	T257-12-1	T257-300-1	Heavy Duty 300mm Jay
C301026	T257-18-1	T257-450-1	Heavy Duty 450mm Jay
C301027	T257-24-1	T257-600-1	Heavy Duty 600mm Jay
C301028	T257-36-1	T257-900-1	Heavy Duty 900mm Jay
C301029	T257-54-1	T257-1350-1	Heavy Duty 1350mm Jay
C301021	T257-2	-	Heavy Duty Moveable Jaw
C301011	T186-24-1	T186-600-1	Standard Duty 600mm Bar
C301014	T186-36-1	T186-900-1	Standard Duty 900mm Bar
C301016	T186-60-1	T186-1500-1	Standard Duty 1500mm Bar
C301018	T186-84-1	T186-2100-1	Standard Duty 2100mm Bar
C301019	T186-96-1	T186-2400-1	Standard Duty 2400mm Bar
C301000	T186-2	-	Standard Duty Moveable Jaw
C301007	T186-13	-	Box Connector
C301100	T321-2	-	Standard Duty Long Reach Moveable Jaw
C301054	T290-36-1	T290-900-1	Medium Duty 900mm Bar
C301057	T290-48-1	T290-1200-1	Medium Duty 1200mm Bar
C301058	T290-60-1	T290-1500-1	Medium Duty 1500mm Bar
C301060	T290-84-1	T290-2100-1	Medium Duty 2100mm Bar
C301043	T290-2	T290-2	Medium Duty Moveable Jaw
C301048	T290	T290-13	Box Connector

Part No.	Model No.	Alternate Model No.	Description
C301034	T285-2	-	Medium Duty Long Reach Moveable Jaw
C301031	T257-84-1	T257-2100-1	Heavy Duty 2100mm Bar
C301033	T257-108-1	T257-2700-1	Heavy Duty 2700mm Bar
C301021	T257-2	-	Heavy Duty Moveable Jaw
C301121	T400-4-1	T400-100-1	Tee Slot Standard Duty 100mm Base Unit
C301122	T400-6-1	T400-150-1	Tee Slot Standard Duty 150mm Base Unit
C301123	T400-8-1	T400-200-1	Tee Slot Standard Duty 200mm Base Unit
C301120	T400-2	-	Tee Slot Standard Duty Head Unit
C301157	T600-2	-	Tee Slot Standard Duty Long Reach Head Unit
C301131	T402-6-1	T402-150-1	Tee Slot Heavy Duty 150mm Base Unit
C301132	T402-12-1	T402-300-1	Tee Slot Heavy Duty 300mm Base Unit
C301133	T402-18-1	T402-450-1	Tee Slot Heavy Duty 450mm Base Unit
C301134	T402-24-1	T402-600-1	Tee Slot Heavy Duty 600mm Base Unit
C301135	T402-30-1	T402-750-1	Tee Slot Heavy Duty 750mm Base Unit
C301136	T402-36-1	T402-900-1	Tee Slot Heavy Duty 900mm Base Unit
C301137	T402-42-1	T402-1050-1	Tee Slot Heavy Duty 1050mm Base Unit
C301138	T402-48-1	T402-1200-1	Tee Slot Heavy Duty 1200mm Base Unit
C301139	T402-54-1	T402-1350-1	Tee Slot Heavy Duty 1350mm Base Unit
C301140	T402-60-1	T402-1500-1	Tee Slot Heavy Duty 1500mm Base Unit
C301130	T402-2	-	Tee Slot Heavy Duty Head Unit
C301239	T602-6F	T602-150F	Heavy Duty 150mm Long Reach (Fabricated Head)
C301240	T602-12F	T602-300F	Heavy Duty 600mm Long Reach (Fabricated Head)
C301241	T602-2F	-	Tee Slot Heavy Duty Long Reach Head Unit (Fabricated)
C301158	T602-2	-	Tee Slot Heavy Duty Long Reach Head Unit
C301160	T614-0	-	Buttress Clamp Standard Duty
C301161	T614-1	-	Buttress Clamp Medium Duty
C301162	T614-2	-	Buttress Clamp Heavy Duty
C301150	T500	-	Machine Vice Low Profile
C301151	T500-1	-	Machine Vice Low Profile Moving Abutment
C301152	T500-2	-	Machine Vice Low Profile Fixed Abutment
C301153	T550	-	Machine Vice Heavy Duty
C301154	T550-1	-	Machine Vice Heavy Duty Moving Abutment
C301155	T550-2	-	Machine Vice Heavy Duty Fixed Abutment
C301242		-	Multiclamp 15mm-300mm Multifunctional Clamp
C301001	T186-03	-	Screw Assembly Standard Duty
C301022	T257-03	-	Screw Assembly Heavy Duty
C301044	T290-03	-	Screw Assembly Medium Duty

Part No.	Model No.	Alternate Model No.	Description
C603300	T805100	-	Spring Rivet Standard Duty
C603302	T805102	-	Spring Rivet Medium/Heavy Duty
C603330	T810100	-	Spring Standard Duty
C603331	T810101	-	Spring Medium Duty
C603332	T810300	-	Spring Heavy Duty
C301171	T62024160	-	T402/T602 M16 Tee Nut
C301300	T105400	-	T440/T600 Fulcrum Pin
C301301	T109400	-	T400/T600 Safety Catch Kit
C301303	T2134001	-	T400/T600 Adjuster Screw
C301304	T104400	-	T400/T600 Rack Box & Safety Catch Assembly
C301305	T105401	-	T402/T602 Fulcrum Pin
C301306	T109402	-	T402/T602 Safety Catch Kit
C301308	T2134011	-	T402/T602 Adjuster Screw
C301309	T104401	-	T402/T602 Rack Box & Safety Catch Assembly
C301310	T813400	-	T402/T602 Column Bracket
C604253	T801402	-	T402/T602 M16 x 50mm Socket Head Cap Screw
C604252	T801401	-	T500/T400/T600 M12 Cap Head Screw
C604271	T802401	-	T614-00 M12 Tee Bolt
C604272	T802402	-	T614-01/T550 M16 Tee Bolt
C604273	T802403	-	T614-01/T550 M20 Tee Bolt
C604274	T802404	-	T614-02 M24 Tee Bolt
C604278	T803600	-	T500 M12 Collar Nut
C604280	T803602	-	T550 M20 Collar Nut
C301156	T550-03-2	-	T550 Serrated Jaw
C301170	T61620120	-	T500/T400/T600 M12 Tee Nut
C504185	T500-03-2	-	T500 Jaw
C603305	T806600	-	T500 Jaw Circlip
C604254	T801600	-	T500 Button Head Jaw Screw
C301243	-	-	Bar
C301244	-	-	Standard Reach Head
C301245	-	-	Long Reach Head
C301000	-	-	Standard Duty Moveable Jaw
C301100	-	-	Standard Duty Long Reach Moveable Jaw
C301246	-	-	M10 x 1.5 x 45 Socket head Screw
C301247	-	-	M10 Helicoil
C301248	-	-	Split Spring Tension Pin
C301249	-	-	Allen Key

CARVER CLAMPS



CARVER & CO. (ENGINEERS) LTD

St. Mary's Road
Nuneaton
Warwickshire
CV11 5AU

T +44 (0) 24 7637 7540

www.carver-clamps.com