

MIG Series

MIG 250P Compact (JM-250P)

Operator Manual



Intertek

CE

UK
CA



Your new product

Thank you for selecting this Jasic product.

This product manual has been designed to ensure that you get the most from your new product. Please ensure that you are fully conversant with the information provided paying particular attention to the safety precautions. The information will help protect yourself and others against the potential hazards that you may come across.

Please ensure that you carry out daily and periodic maintenance checks to ensure years of reliable and trouble free operation.

Please call your Jasic distributor in the unlikely event of a problem occurring.
Please record below the details from your product as these will be required for warranty purposes and to ensure you get the correct information should you require assistance or spare parts.

Date purchased _____

From where _____

Serial number _____

(The serial number is normally located on the top or underside of the machine and will begin with AA).

For further information on your Jasic product warranty registration please visit:

www.jasic-warranty.co.uk

Disclaimer

Whilst every effort has been made to ensure that the information contained within this manual is complete and accurate, no liability can be accepted for any errors or omissions.

Please note:

Products are subject to continual development and may be subject to change without notice.
Regularly check our product pages at www.Jasic.co.uk for revision updated operating manuals.

No part of this manual may be copied or reproduced by any means without the written permission of Wilkinson Star Limited.

CONTENTS

Index	Page
Your New Product	2
Index	3
Safety Instruction	4
General electrical safety	4
General operating safety	4
PPE	5
Welding processes lens shade selector guide	5
Fume and welding gases	6
Fire risks	6
The working environment	7
Protection from moving parts	7
Magnetic fields	7
Compressed gas cylinders and regulators	7
RF declaration	8
LF declaration	8
Materials and their disposal	8
Product Overview	9
Technical Specifications	10
Description of Controls	11
Error Codes	16
Secondary menu	17
Torch trigger operation modes	19
Installation	20
Operation MIG	22
MIG quick set-up guides	24
Guide to MIG/MAG Welding	30
Spool Gun Operation	34
MIG Welding Guide	35
MIG Welding Problems	36
MIG Torch Spare Parts List	38
Operation MMA	39
Guide to MMA Welding	40
MMA Welding Problems	44
Operation TIG	45
Guide to TIG Welding	46
TIG Welding Problems	50
Maintenance and Service Schedule Record	52
Troubleshooting	53
WEEE Disposal	54
RoHS Compliance Declaration	54
UKCA Declaration of Conformity	54
EC Declaration of Conformity	55
Statement of Warranty	56
Schematic	57
Options and Accessories	58
Notes	59
Jasic Contact Details	60

SAFETY INSTRUCTION

These general safety norms cover both arc welding machines and plasma cutting machines unless otherwise noted.

It is important that users of this equipment protect yourselves and others from harm or even death. The equipment must only be used for the purpose it was designed for. Using it in any other way could result in damage or injury and in breach of the safety rules.

Only suitably trained and competent persons should use the equipment.

Pacemaker wearers should consult your doctor prior to using this equipment.

PPE and workplace safety equipment must be compatible for the application of work involved.

Always carry out a risk assessment before undertaking any welding or cutting activity

General electrical safety



The equipment should be installed by a qualified person and in accordance with current standards in accordance with current standards in operation. It is the users responsibility to ensure that the equipment is connected to a suitable power supply. Consult with your utility supplier if required. Do not use the equipment with the covers removed.

Do not touch live electrical parts or parts which are electrically charged.

Turn off all equipment when not in use.

In the case of abnormal behaviour of the equipment, the equipment should be checked by a suitably qualified service engineer.

If earth bonding of the work piece is required, bond it directly with a separate cable with a current carrying capacity capable of carrying the maximum capacity of the machine current.

Cables (both primary supply and welding) should be regularly checked for damage and overheating.

Never use worn, damaged, under sized or poorly jointed cables.

Insulate yourself from work and earth using dry insulating mats or covers big enough to prevent any physical contact.

Never touch the electrode if you are in contact with the work piece return.

Do not wrap cables over your body.

Ensure that you take additional safety precautions when you are welding in electrically hazardous conditions such as damp environments, wearing wet clothing and metal structures.

Try to avoid welding in cramped or restricted positions.

Ensure that the equipment is well maintained. Repair or replace damaged or defective parts immediately.

Carry out any regular maintenance in accordance with the manufacturers instructions.

The EMC classification of this product is class A in accordance with electromagnetic compatibility standards CISPR 11 and IEC 60974-10 and therefore the product is designed to be used in industrial environment only.

WARNING: This class A equipment is not intended for use in residential locations where the electrical power is provided by a public low-voltage supply system. In those locations it may be difficult to ensure the electromagnetic compatibility due to conducted and radiated disturbances.

General operating safety

Never carry the equipment or suspend it by the carrying strap or handles during welding.

Never pull or lift the machine by the welding torch or other cables. Always use the correct lift points or handles. Always use the transport under gear as recommended by the manufacturer.

Never lift a machine with the gas cylinder mounted on it.

If the operating environment is classified as dangerous, only use S-marked welding equipment with a safe idle voltage level. Such environments may be for example: humid, hot or restricted accessibility spaces.

SAFETY INSTRUCTION

Use of Personal Protective Equipment (PPE)

Welding arc rays from all welding processes produce intense, visible and invisible (ultraviolet and infrared) rays that can burn eyes and skin.

- Wear an approved welding helmet fitted with an appropriate shade of filter lens to protect your face and eyes when welding or watching.
- Wear approved safety glasses with side shields under your helmet.
- Never use broken or faulty welding helmets.
- Always ensure there are adequate protective screens or barriers to protect others from flash, glare and sparks from the welding area.
- Ensure that there are adequate warnings that welding or cutting is taking place.
- Wear suitable protective flame resistant clothing, gloves and footwear.
- Check and be sure the area is safe and clear of inflammable material before carrying out any welding.

Some welding and cutting operations may produce noise. Wear safety ear protection to protect your hearing if the ambient noise level exceeds the local allowable limit (e.g: 85 dB).



Welding and Cutting Lens Shade Selector Guide

CURRENT	MMA ELECTRODES	MIG LIGHT ALLOYS	MIG HEAVY METALS	MAG	TIG ON ALL METALS	PLASMA CUTTING	PLASMA WELDING	GOUGING ARC/AIR
10	8							
15								
20	9	10	10	10	10			
30								
40	10					11	11	10
60								
80	11	11		11	11			
100								
125	12	12	11	12	12		12	
150								
175	13	13		12			13	11
200								
225	14	14	12	13	13	12		12
250								
275	15	15						13
300								
350	13	14	13	14	14	13	14	14
400								
450	14	15	14	15				15
500								

SAFETY INSTRUCTION

Safety against fumes and welding gases



Warning
Fumes and
Gases

The HSE have identified welders as being an 'at risk' group for occupational diseases arising from exposure to dusts, gases, vapours and welding fumes. The main identified health effects are pneumonia, asthma, chronic obstructive pulmonary disease (COPD), lung and kidney cancer, metal fume fever (MFF) and lung function changes.

During welding and hot cutting 'hot work' operations, fumes are produced which are collectively known as welding fume. Depending upon the type of welding process being performed, the resultant fume generated is a complex and highly variable mixture of gases and particulates.

Regardless of the length of welding being carried out, all welding fume, including mild steel welding requires suitable engineering controls to be in place which is usually Local Exhaust Ventilation (LEV) extraction to reduce the exposure to welding fume indoors and where LEV does not adequately control exposure it should also be enhanced by using suitable respiratory protective equipment (RPE) to assist with protecting against residual fume.

When welding outdoors appropriate RPE should be used.

Prior to undertaking any welding tasks an appropriate risk assessment should be carried out to ensure expected control measures are in place.

Locate the equipment in a well-ventilated position and keep your head out of the welding fume.

Do not breathe the welding fume.

Ensure the welding zone is well-ventilated and provision should be made for suitable local fume extraction system to be in place.

If ventilation is poor, wear an approved airfed welding helmet or respirator.

Read and understand the Material Safety Data Sheets (MSDS's) and the manufacturer's instructions for metals, consumable, coatings, cleaners and de-greasers.

Do not weld in locations near any de-greasing, cleaning or spraying operations.

Be aware that heat and rays of the arc can react with vapours to form highly toxic and irritating gases.

For further information please refer to the HSE website www.hse.gov.uk for related documentation.



An example of personal fume protection

Precautions against fire and explosion



Warning
Fire Risk

Avoid causing fires due to sparks and hot waste or molten metal. Ensure that appropriate fire safety devices are available near the welding and cutting area.

Remove all flammable and combustible materials from the welding, cutting and surrounding areas.

Do not weld or cut fuel and lubricant containers, even if empty. These must be carefully cleaned before they can be welded or cut.

Always allow the welded or cut material to cool before touching it or placing it in contact with combustible or flammable material.

Do not work in atmospheres with high concentrations of combustible fumes, flammable gases and dust. Always check the work area half an hour after cutting to make sure that no fires have begun.

Take care to avoid accidental contact of electrode to metal objects. This could cause arcs, explosion, overheating or fire.



Understand your fire extinguishers

SAFETY INSTRUCTION

The working environment

Ensure the machine is mounted in a safe and stable position allowing for cooling air circulation.

Do not operate equipment in an environment outside the laid down operating parameters.

The welding power source is not suitable for use in rain or snow.

Always store the machine in a clean, dry space.

Ensure the equipment is kept clean from dust build up.

Always use the machine in an upright position.

Protection from moving parts

When the machine is in operation keep away from moving parts such as motors and fans.

Moving parts, such as the fan, may cut fingers and hands and snag garments.

Protections and coverings may be removed for maintenance and controls only by qualified personnel after first disconnecting the power supply cable.

Replace the coverings and protections and close all doors when the intervention is finished and before starting the equipment.

Take care to avoid getting fingers trapped when loading and feeding wire during set up and operation.

When feeding wire be careful to avoid pointing it at other people or towards your body.

Always ensure machine covers and protective devices are in operation.

Risks due to magnetic fields



The magnetic fields created by high currents may affect the operation of pacemakers or electronically controlled medical equipment.

Wearers of vital electronic equipment should consult their physician before beginning any arc welding, cutting, gouging or spot welding operations.

Do not go near welding equipment with any sensitive electronic equipment as the magnetic fields may cause damage.

Keep the torch cable and work return cable as close to each other as possible throughout their length.

This can help minimise your exposure to harmful magnetic fields.

Do not wrap the cables around the body.

Handling of compressed gas cylinders and regulators

Mishandling gas cylinders can lead to rupture and the release of high pressure gas

Always check the gas cylinder is the correct type for the welding to be carried out.

Always store and use cylinders in an upright and secure position.

All cylinders and pressure regulators used in welding operations should be handled with care.

Never allow the electrode, electrode holder or any other electrically “hot” parts to touch a cylinder.

Keep your head and face away from the cylinder valve outlet when opening the cylinder valve.

Always secure the cylinder safely and never move with regulator and hoses connected.

Use a suitable trolley for moving cylinders.

Regularly check all connections and joints for leaks.

Full and empty cylinders should be stored separately.

Never deface or alter any cylinder

SAFETY INSTRUCTION

RF Declaration

Equipment that complies with directive 2014/30/EU concerning electromagnetic compatibility (EMC) and the technical requirements of EN60974-10 is designed for use in industrial buildings and not those for domestic use where electricity is provided via the low voltage public distribution system. Difficulties may arise in assuring class A electromagnetic compatibility for systems installed in domestic locations due to conducted and radiated emissions. In the case of electromagnetic problems, it is the responsibility of the user to resolve the situation. It may be necessary to shield the equipment and fit suitable filters on the mains supply.

LF Declaration

Consult the data plate on the equipment for the power supply requirements. Due to the elevated absorbance of the primary current from the power supply network, high power systems affect the quality of power provided by the network. Consequently, connection restrictions or maximum impedance requirements permitted by the network at the public network connection point must be applied to these systems. In this case, the installer or the user is responsible for ensuring the equipment can be connected, consulting the electricity provider if necessary.

Materials and their disposal

Welding equipment is manufactured with BSI published standards meeting CE requirements materials which do not contain any toxic or poisonous materials dangerous to the operator. Do not dispose of the equipment with normal waste. The European Directive 2012/19/EU on Waste Electrical and Electronic Equipment states the electrical equipment that has reached its end of life must be collected separately and returned to an environmentally compatible recycling facility for disposal.

For more detailed information please refer to the HSE website www.hse.gov.uk

PRODUCT OVERVIEW

The Jasic Compact MIG inverter range of welding machines have been designed as integrated and portable welding power supply units incorporating the most advanced IGBT inverter technology in power electronics with easy operation and adjustment due to friendly user interface.

Unique electric structure and air channel design in this series of machines can speed up the heat dissipation of the power devices as well as improving the duty cycles of the machines. The unique heat rejection efficiency of the air channel can effectively prevent the power devices and control circuits from being damaged by the dust absorbed by the fan and thereby, the reliability of the machine is greatly improved.

The front panel is naturally integrated via large-radius transition manner. The front panel of the machine and the handle is coated with rubber oil, so the machine has soft texture, good hand feeling that feels warm and comfortable to hold.



Jasic MIG 250P Compact Product Features:

- Advanced IGBT multi process inverter technology
- Compact modern design 26.5kHz inverter
- The JM-250P is a single phase 230V AC machine
- Welding modes include DC Pulse MIG/MAG, MMA and Lift TIG
- Functions such as accurate preset current/voltage, 2T/4T, spot operation trigger modes, synergic, gas selection, wire diameter selection, electronic inductance adjustment and on-demand fan are available
- With synergic MIG, welding parameters can be automatically selected based on wire feed speed.
- Synergic curves for common materials and wires
- Designed for gas and gasless MIG welding wires
- Four roll wire drive unit
- Built in hot start arc ignition function which ensures excellent arc ignition in MMA for easier and more reliable arc starting
- Built in self adaptive arc force technology which maintains the optimum MMA arc conditions during operation even with long welding cables
- DC MMA suitable for a wide range of electrodes in MMA
- Inbuilt VRD (MMA and TIG mode only)
- Excellent weld characteristics
- Auto compensation for mains voltage fluctuation with automatic protective functions including over-current, overload etc.
- Easy arc starting, low spatter, stable current which offers good weld bead shape
- High quality tactile finish to mouldings and handle
- Spool gun interface
- The MIG 250P is supplied with a MIG torch model T250-3, gas regulator, gas hose, work return lead and clamp

TECHNICAL SPECIFICATIONS

Parameter	Unit	Jasic MIG 250P (JM-250P)
Rated input voltage	V	AC230V±15% 50/60Hz
Rated input power	kVA	9.13
Rated input current I _{max}	A	46.3
Rated input current I _{eff}	A	29.2
Output voltage range	V	13.5 ~ 36
Welding current range	A	MIG-MIG Pulsed 40 ~ 250 MMA 15 ~ 220 Lift TIG 15 ~ 250
No-load voltage	V	MIG - 75 MMA - 75 MMA (VRD) - 17 Lift TIG - 20
Output characteristic	-	MIG/MAG - CV MMA/TIG - CC
Rated duty cycle (40°C)	%	MIG 250A @ 40% MMA 220A @ 40% Lift TIG 250A @ 40%
Suitable wire size	mm	0.8 ~ 1.2
Wire feed range	m/min	3 ~ 16
Wire feed drive	-	4 Roll
Wire spool size/weight	mm/Kg	300mm / 15Kg
Efficiency	%	81
Idle State Power	W	< 50
Power factor	cosφ	0.76
Standard	-	EN60974-1
Protection class	IP	IP21S
Insulation class	-	F
Noise	dB	<70
Operating temperature range	°C	-10 ~ +40
Storage temperature	°C	-25 ~ +55
Overall size	mm	900 x 450 x 755
Weight	Kg	49.7

Please Note

Due to variations in manufactured products all claimed performance ratings, capacities, measurements, dimensions and weights quoted are approximate only. Achievable performance and ratings when in use can depend upon correct installation, applications and use along with regular maintenance and service.

CONTROLS

Front view Jasic MIG 250P

1. Digital ammeter
2. Adjusting knob
3. Gas check button
4. Welding parameter selector button
5. Welding mode selector button
6. Welding material selector button
7. Euro torch connector
8. Spool gun control socket
9. Digital voltmeter
10. Adjusting knob
11. Synergic selector button
12. MIG trigger mode selector button
13. Wire diameter selector button
14. "+" Output terminal
15. Polarity selector cable
16. "-" Output terminal

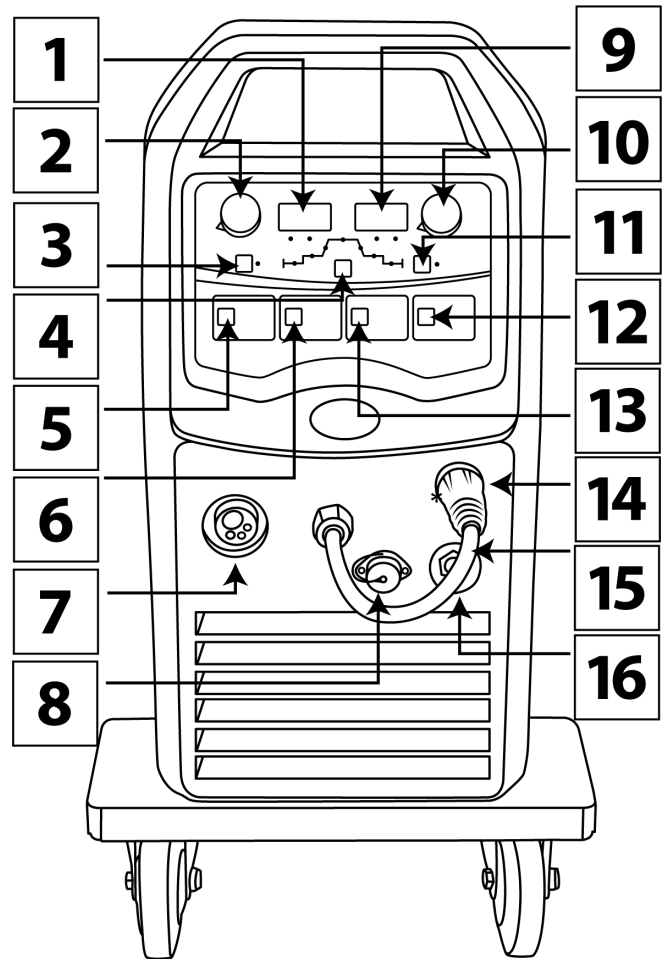

Rear view Jasic MIG 250P

17. Mains power ON/OFF switch
18. Power cable
19. Heater power socket (when fitted)
20. Shield gas inlet
21. Cooling fan

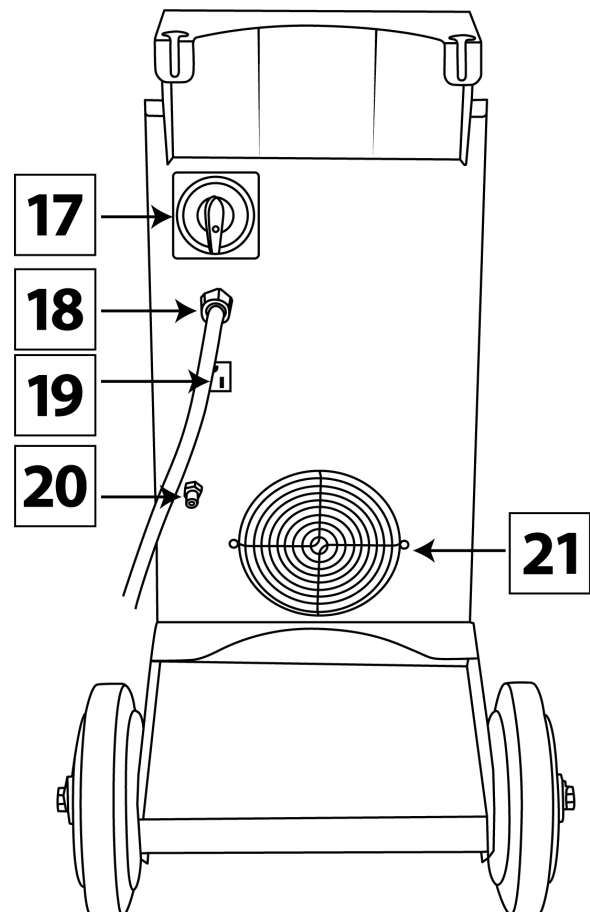

CONTROLS

Inside view Jasic MIG 250P

1. Wire spool holder and tensioner:
Allows a 15Kg (300mm dia) reel of wire to be located in place via an alignment pin and then locked in place with the locking nut. The spool holder also has a brake arrangement to ensure correct tension of the wire, this is done by turning the central bolt with an Allen key clockwise (to tighten) or anti clockwise (to loosen)

2. Wire inch button. This is used to feed wire during set up

3. N/A

4. Drive assembly feed motor and gearbox

5. Drive roll tensioner: Allows the correct amount of tension to be applied to the top roller to ensure good feed of the wire through the MIG torch

6. Inlet wire guide: The welding wire is fed through the inlet guide prior to feeding through the drive rollers

7. Outlet feed adaptor: Part of the Euro outlet connector which contains the inner outlet guide which ensures smooth wire feed from the drive assembly through to the MIG torch

8. Drive gear: Geared roll drives the feed roll system

9. Wire feed roller and retaining nut*: Secures and holds the grooved drive rolls in place

10. Pressure roll assembly*: Holds the upper drive roll in place which applies pressure to the welding wire via the installed grooved drive roll

11. Intermediate wire guide: Ensures the wire passes in between the 2 feed rollers smoothly

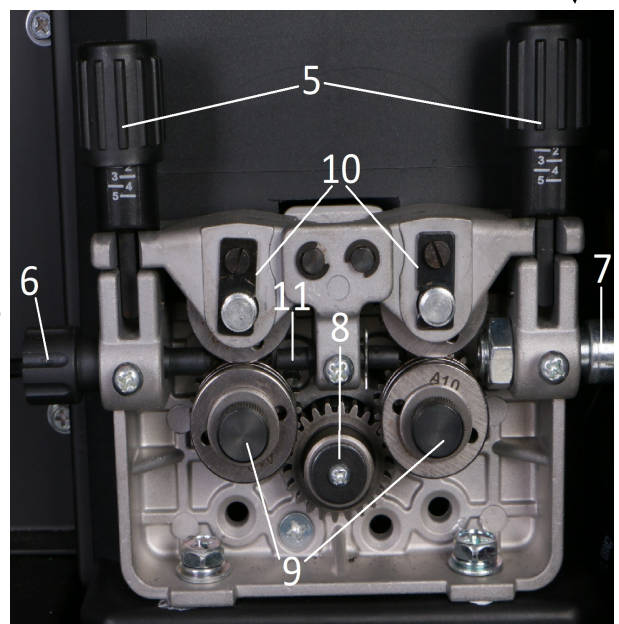
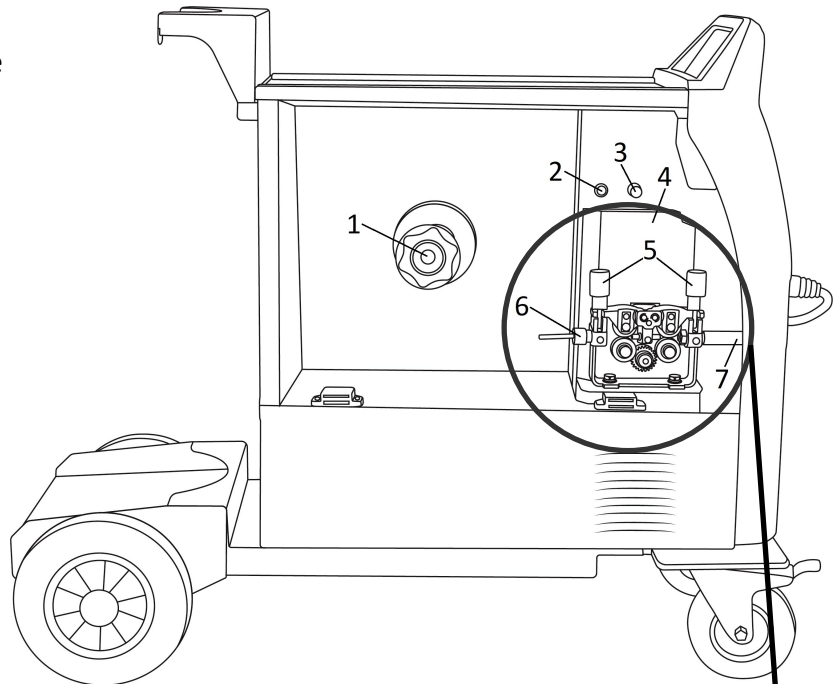

CONTROLS

Control panel view Jasic MIG 250P



1. Operation mode selection control dial/switch
2. Digital ammeter and system information display
3. Digital voltage and system information display
4. Parameter adjustment control dial/switch
5. Gas purge switch
6. Welding parameter area and selection switch
7. Synergic control switch
8. Welding mode selection control switch
9. Welding material selection control switch
10. Welding wire diameter selection control switch
11. MIG trigger mode selection control switch

Welding mode selection switch (8)

The welding mode selection zone contains welding mode indicators and the selection Switch (A).

Four welding modes including Lift TIG DC, MIG/MAG, Pulse MIG/MAG and MMA can be selected by pressing the welding mode selection key to choose the according welding mode.

The corresponding indicator will be lit according to the selected welding mode.

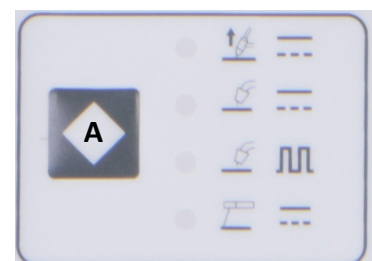

CONTROLS

Operation mode selection control knob (1)

This control dial knob is a combined rotary encoder and selection push button. Current setting or secondary menu can be adjusted by rotating the dial. Press the menu selection button for 2 seconds to access the secondary menu options which will be shown on the corresponding digital display, then rotating the encoder will show you the relevant options and these options can be adjusted by then rotating the 'plate thickness' dial/encoder.



Current parameters selecting display (2)

This display shows current parameters, system information and indicators. Parameters including current (A), wire feed speed (m/min) and secondary menu can be selected by rotating the encoder. System information, pre-set and actual welding current and secondary menu functions can be displayed. The corresponding indicator will be lit and information will be displayed according to selected parameters.



When there is welding current, actual welding current value will be displayed.

Parameters adjusting knob (4)

This control dial is a combined rotary encoder and selection push button. MIG voltage adjustment is made with this dial as well as setting the plate thickness parameter (active in synergic mode only) can be adjusted by rotating this encoder.



When in either MIG synergic and synergic pulse mode, to access plate thickness, press and hold the button for 2 seconds, plate thickness is displayed (range 0.5 ~ 10mm) and rotate the dial to adjust, press and hold the button for 2 seconds again to set the material thickness required.

When in synergic mode this control dial also allows the user to control the voltage/arc length trim, the trim adjustment scale varies from -30 ~ +30 which is shown on the display with the factory suggested starting point being zero.

Voltage parameters selecting zone (3)

This display shows voltage parameters, material thickness and other system information. System information including actual welding voltage can be displayed. Parameters including voltage (V), time (S), duty ratio (%), frequency (Hz) and function parameters can be selected by rotating the encoder, while relevant secondary menu information will be displayed based on selected parameters.

When there is welding current, actual voltage value will be shown.



CONTROLS

Welding procedure parameters selecting zone (6)

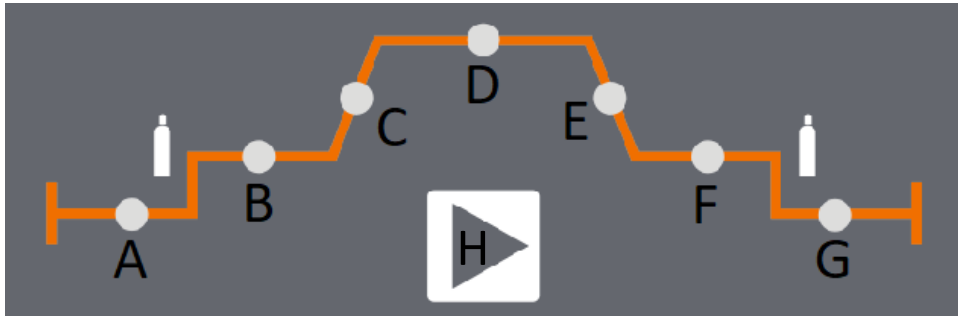

The parameter selection button (H) allows you to scroll through the MIG adjustable procedure parameters for conventional MIG and pulse MIG modes as follows:

- A. P-1: Gas pre-flow time (range 0.1 to 10 seconds, default 0.5)
- B. P-2: Initial parameters (range 40 to 250* amps, default 40)
- C. P-3: Upslope time (range 0.1 to 5 seconds, default 0.1)
- D. Peak welding current (range 30 to 250 amps)
- E. P-4: Downslope time (range 0.1 to 5 seconds, default 0.1)
- F. P-5: Final arc parameters and post-set parameter (range 40 to 250* amps, default 40)
- G. P-6: Post-flow time (range 0.1 to 10 seconds, default 2)
- H. Parameter selection button

* subject to wire size being used

The corresponding indicators will be lit according to selected parameters, the variable setting is noted in the left display and the adjustable values are shown on the right displays which are adjusted using the right control dial.

Gas check (5)

The gas check button indicator. When the gas check button (A) is pressed it opens the gas valve to allow gas flow which allows for the checking and purging of the welding gas.



The gas valve closes and flow stops when you release the button.

The gas indicator will be lit when the valve is on.

Synergic mode switch (7)

The synergic button (B) and synergic indicator. When the synergic button is pressed it enables plate thickness to be set along with the synergic programs to become effective, synergic means when a single setting is adjusted i.e. MIG voltage or material thickness then other settings like current or wire speed will also change according. The synergic indicator will be lit when operating in synergic mode and pressing the button again takes you out of synergic mode.



Please note:

Pressing and holding the synergic mode button for 7 seconds re-sets the front panel to factory default.

CONTROLS

Material selecting zone (9)

Material indicators and selection button.

Materials including carbon steel, stainless steel, aluminum-silicon alloy and aluminum-magnesium alloy can be selected by pressing the selection button. The corresponding indicator will be lit according to selected material.

Note: This function is not available in Lift TIG and MMA mode.

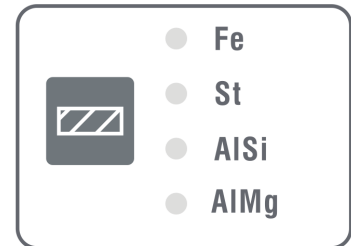

Welding wire diameter selecting zone (10)

Welding wire size indicators and selection button.

Welding wires including 0.8, 1.0 and 1.2mm diameter and SP can be selected by pressing the selection button. The corresponding indicator will be lit according to selected welding wire.

Note: This function is not available in Lift TIG and MMA mode.

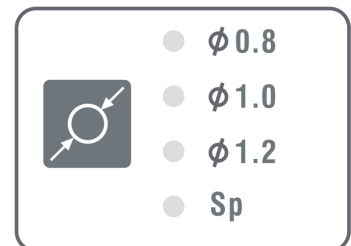

Welding operation selecting zone (11)

Torch trigger mode indicators and selection button.

Operation methods including spot, 2T and 4T can be selected by pressing the button. The corresponding indicator will be lit according to selected operation method (See page 19 for further Information)

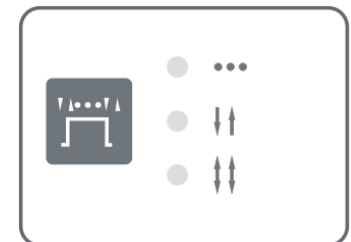

Please Note:

When in MMA mode, the spot LED is also used to confirm that VRD is either ON or OFF. When welding mode output is set to MMA, use the selection button to turn VRD on or off, when the spot LED lights up, it indicates that VRD output is active.

ERROR CODES:

The control panel digital display will show an error code if the machine detects an internal error, below are the inbuilt error codes available for this machine.

Fault code	Fault name	Description
E-1	Over-current	Unacceptable welder current or low driving voltage
E-2	Overheat	Temperature of welder inverter exceeds working temperature of thermal, fault with thermal sensor
E-3	Wire feeding failure	Wire feeder drive fails, wire feed motor fails or motor supply fault

CONTROLS

Description of welding functions and secondary menu

MMA mode

Select MMA mode, to turn on VRD when in MMA mode, press and activate the 'spot' function which when the spot LED is ON then VRD is active. (factory preset is OFF for VRD).

The secondary menu includes hot start current and arc-force current adjustment; to access press and hold the 'menu' (left) dial until S - is shown on the display and then rotate the dial to adjust through each function, the settings can be adjusted by rotating the 'plate thickness' right hand dial.

 S indicates a 120A hot start current, hot start range is 0 to 150amps (default 50)

 F indicates a 110A arc force current, arc force range is 0 to 150amps (default 50)

Lift TIG welding mode

There is no secondary menu options available in Lift TIG mode.

DC MIG standard mode

1. The left encoder is pressed and held to open the secondary menu and is rotated to switch between menu modes, while the right encoder is to adjust the secondary option selected.
2. Secondary menu includes electronic inductance, crater time, crater voltage and spot time.

 L indicates 10 scale of electronic inductance, inductance range is -20 to +20 (default 0)

 Bt indicates 115ms crater time, crater time range is 50 to 300 milliseconds (default 200)

 BU indicates 15.1V crater voltage, crater voltage range is 5 to 30 volts (default 10)

 Sp indicates 1.5s spot time, spot time range is 0.2 to 5 seconds (default 0.5)

DC MIG synergic mode

1. The left encoder is pressed and held to open the secondary menu and is rotated to switch between menu modes, while the right encoder is to adjust the secondary option selected.
2. Secondary menu includes electronic inductance, burn-back time, burn-back voltage and spot time.

 L indicates 10 scale of electronic inductance, inductance range is -20 to +20 (default 0)

 Bt indicates 115ms crater time, crater time range is 50 to 300 milliseconds (default 200)

 BU indicates 15.1V crater voltage, crater voltage range is 5 to 30 volts (default 10)

 Sp indicates 1.5s spot time, spot time range is 0.2 to 5 seconds (default 0.5)



Please Note: Spot time is only available when the SPOT function is "ON".

CONTROLS

Description of welding functions and secondary menu

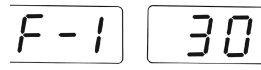
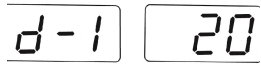

DC MIG pulse mode

1. The left encoder is pressed and held to open the secondary menu and is rotated to switch between menu modes, while the right encoder is to adjust the secondary option selected.
2. Secondary menu includes pulse frequency, pulse duty ratio, electronic inductance and spot time.

	F indicates pulse frequency tuning scale of synergic, range is 5 to 200 (default is 60)
	d indicates % duty ratio or scale tuning, range is 1.5 to 95 (default is 10)
	L indicates 10 scale of electronic inductance, inductance range is -20 to +20 (default 0)
	Sp indicates 1.5s spot time, range is 0.2 to 5.0 seconds (only active when in spot mode)

DC MIG pulse mode Synergic

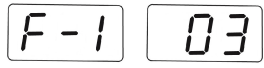
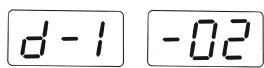
1. The left encoder is pressed and held to open the secondary menu and is rotated to switch between menu modes, while the right encoder is to adjust the secondary option selected.
2. Secondary menu includes pulse frequency, pulse duty ratio, electronic inductance and spot time.

	F indicates frequency tuning scale of synergic, range is -10 to +10 (default is 0 in synergic)
	d indicates -12% duty ratio or scale tuning, range is -5.0 to +5.0 (default is 0 in synergic)
	L indicates 10 scale of electronic inductance, inductance range is -20 to +20 (default 0)
	Sp indicates 1.5s spot time, range is 0.2 to 5.0 seconds (only active when in spot mode)

Please Note: Spot time is only available when the SPOT function is "ON".

CONTROLS

Torch trigger operation modes

2T operation mode

Press the torch trigger to ignite the welding arc, the arc is extinguished when you release the trigger.

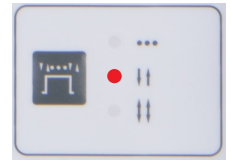
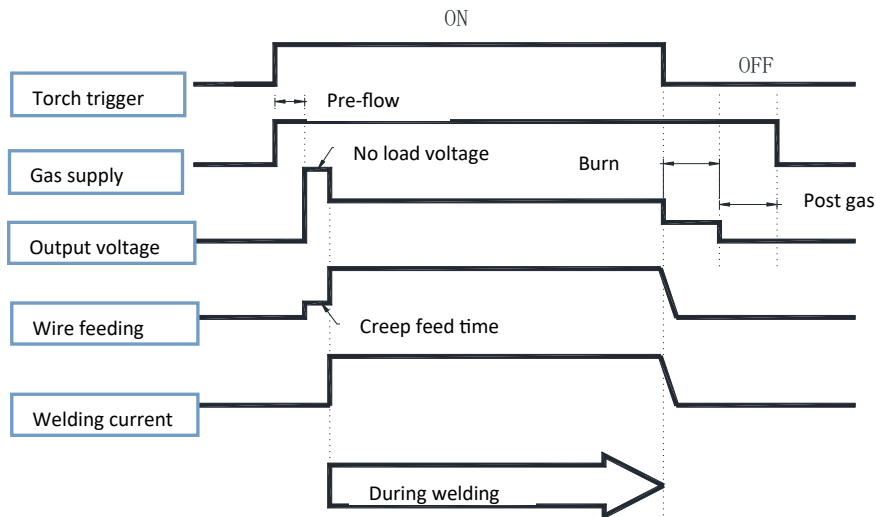

4T operation mode

When the torch trigger is pressed to start the process, welding begins and continues to work even after the torch trigger is released (current and voltage setting dials on the control panel will still adjust the welding condition).

At this time, the digital meters will display the actual current and voltage respectively.

When torch trigger is pressed again, stopping the arc is effected (welding/crater current and crater voltage parameters in the welding settings can adjust welding condition).

The welding process stops when the torch trigger is released and post flow gas time will start.

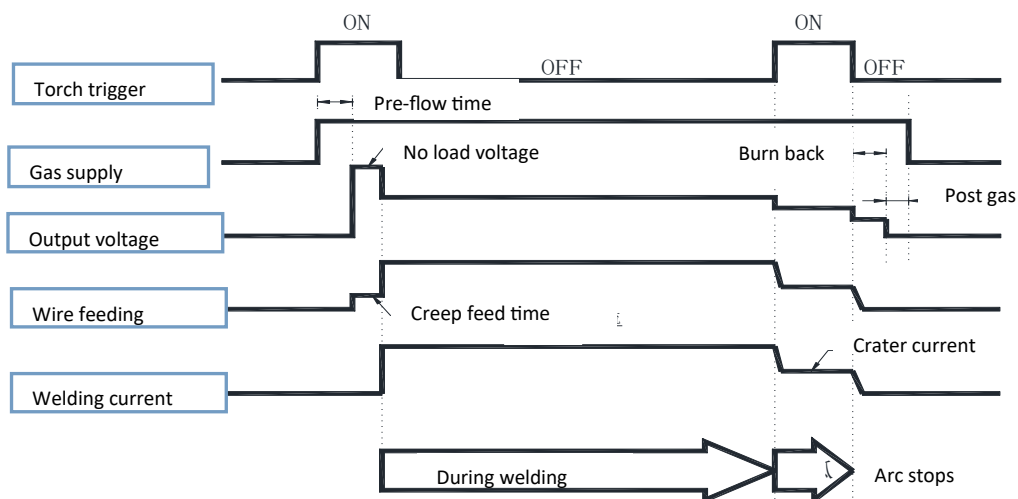

Spot operation mode

The spot welding mode is used for welding short welds of the same length. Pressing the torch button activates the time circuit that starts and end the welding procedure. Once welding has stopped you can release the torch trigger.

Please Note: Spot time is only available when Spot welding mode is "ON".

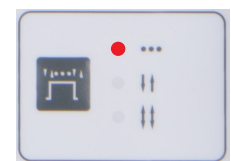

INSTALLATION

Unpacking

Check the packaging for any signs of damage.

Carefully remove the machine and retain the packaging until the installation is complete.

Location

The machine should be located in a suitable position and environment. Care should be taken to avoid moisture, dust, steam, oil or corrosive gases.

Place on a secure level surface and ensure that there is adequate clearance around the machine to ensure natural airflow.

Input connection

Before connecting the machine you should ensure that the correct supply is available. Details of the machine requirements can be found on the data plate of the machine or in the technical parameters shown in the manual.

The equipment should be connected to the appropriate mains supply by a suitably qualified person. Always ensure the equipment has a proper grounding.

Never connect the machine to the mains supply with the panels removed.

Output connections

Electrode polarity

In general when using manual arc welding electrodes the electrode holder is connected to the positive terminal and the work return to the negative terminal. Always consult the electrode manufacturer's data sheet if you have any doubts.

MMA welding

Insert the cable plug with electrode holder into the "+" socket on the front panel of the welding machine and tighten it clockwise.

Insert the cable plug of the work return lead into the "-" socket on the front panel of the welding machine and tighten it clockwise.

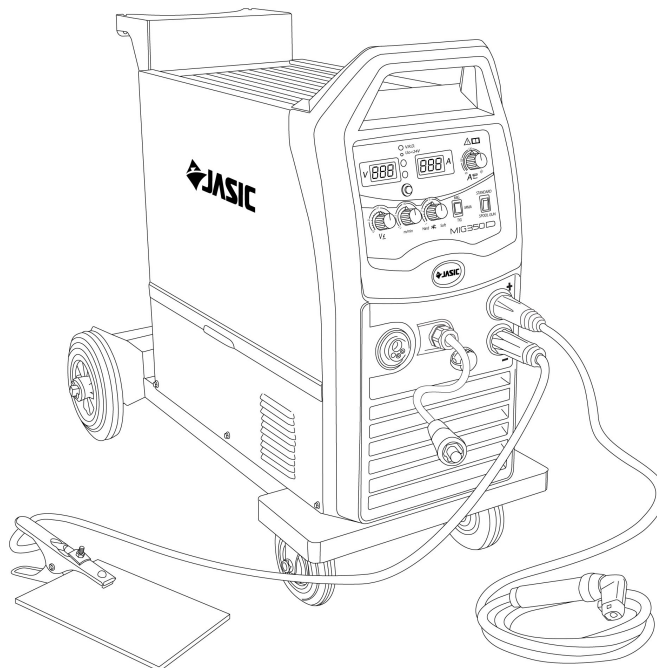

Control panel model shown as example is the JM-352C

INSTALLATION

MIG/MAG welding

Insert the welding torch (C) into the “Euro connector for torch in MIG” output socket on the front panel of the machine and tighten it.

Insert the trailing cable plug (A) into the “+” output terminal of the welding machine and tighten it clockwise.

Insert the work return lead cable plug (B) into the “-” output terminal on the front panel of the welding machine and tighten it clockwise.

Install the welding wire on the spindle adapter.

Connect the cylinder equipped with a gas regulator to the gas inlet on the back panel of the machine with a gas hose. Correctly set the gas flow.

Ensure that the roller groove size on the fitted drive roll matches the contact tip size of the welding torch and the wire size being used.

Release the pressure arm of the wire feeder to thread the wire through the guide tube and into the drive roll groove and then adjust the pressure arm, ensuring no sliding of the wire. (too much pressure will lead to wire distortion which will affect wire feeding performance).

Press the wire inch button to feed the wire through the torch until the wire comes through the contact tip. You are now ready to start MIG welding.

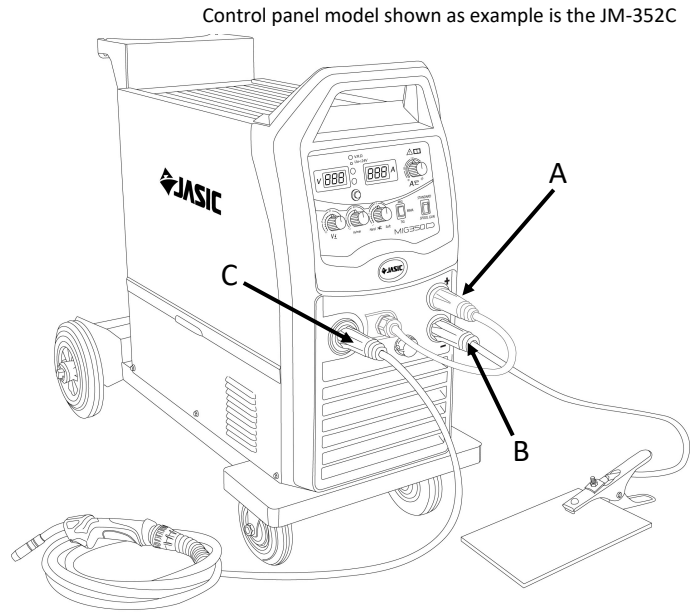

MIG welding using gasless, self shielded MIG wire

Insert the welding torch (D) into the “Euro connector for torch in MIG” output socket on the front panel of the machine and tighten it.

Insert the work return cable plug (E) into the “+” output terminal of the welding machine and tighten it clockwise.

Insert the trailing cable plug (F) into the “-” output terminal on the front panel of the welding machine and tighten it clockwise.

Install the wire spool on the spindle adapter ensuring that the roller groove size on the drive roll fitted matches the contact tip size of the welding torch and the wire size being used.

Release the pressure arm of the wire feeder to thread the wire through the guide tube and into the drive roll groove.

Adjust the pressure arm ensuring no sliding of the wire. (Too much pressure will lead to wire distortion which will affect wire feeding performance).

Press the wire inch button to feed the wire through the torch until the wire comes through the contact tip. You are now ready to start gasless MIG welding.

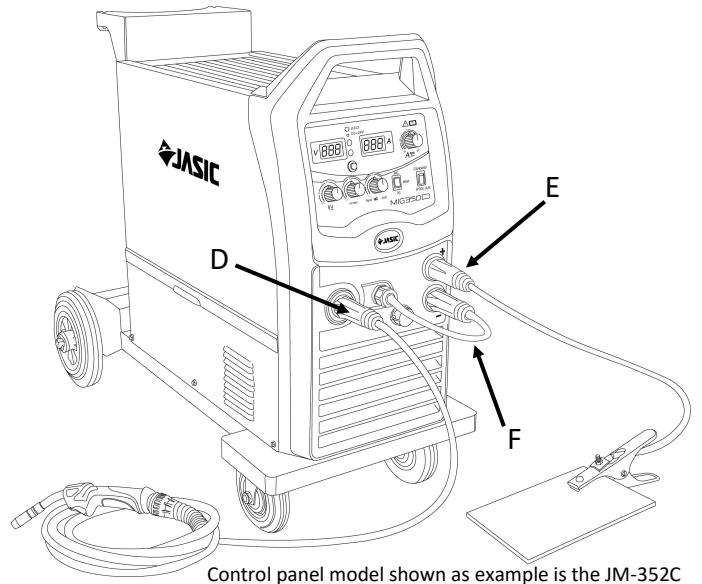

OPERATION - MIG



Before starting any welding activity ensure that you have suitable eye protection and protective clothing. Also take the necessary steps to protect any persons within the welding area.

MIG/MAG standard or pulse welding mode

MIG - Metal Inert Gas Welding, MAG - Metal Active Gas Welding, GMAW - Gas Metal Arc Welding

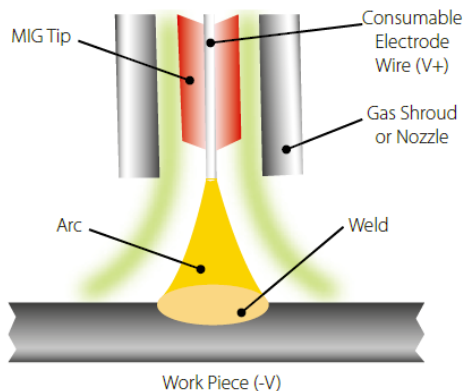

MIG welding was developed to help meet production demands of the war and post war economy which is an arc welding process in which a continuous solid wire electrode is fed through a MIG welding gun and into the weld pool, joining the two base materials together.

A shielding gas is also sent through the MIG welding gun and protects the weld pool from contamination which also enhances the arc.

Connect the MIG torch leads as detailed on page 21. Work return lead to '-' (B) and torch trailing lead to '+' (A).

Ensure that a suitable inert gas supply is connected.

Switch the power switch on the back panel to "ON" the machine is started with the power LED on and the fans are running.

Open the gas valve of the cylinder and adjust the gas regulator to obtain the desired flow rate.

Depending on your exact MIG welding requirements you can follow the instructions below to obtain your optimum setup.

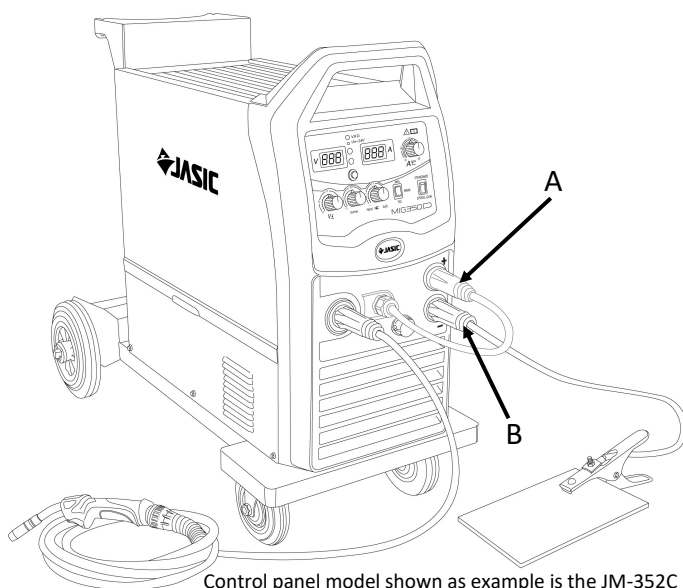

Control panel model shown as example is the JM-352C

Welding mode:

Press the TIG/MIG/MMA button (C) to select either MIG or MIG Pulse welding mode. The corresponding indicator will be lit according to selected material.



Material choice:

Select the material being welded, materials choice includes; carbon steel (Fe), stainless steel (St), aluminium-silicon alloy and aluminium-magnesium alloy can be selected by pressing the selection button (D).

The corresponding indicator will be lit according to selected material.

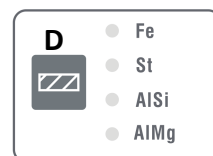

Wire size:

Press the wire size button (E) to select the size of welding wire you have fitted within the machine, wire size choice is 0.8mm, 1.0mm or 1.2mm and Sp (special), your choice will depend on which material and welding process you have previously selected.

The corresponding indicator will be lit according to selected wire size choice.

The corresponding indicator will be lit according to selected operation method.

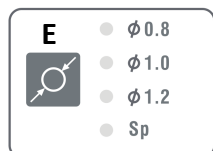

OPERATION - MIG



Before starting any welding activity ensure that you have suitable eye protection and protective clothing. Also take the necessary steps to protect any persons within the welding area.

MIG/MAG standard or pulse welding mode (continued)

Torch trigger mode

Press the torch trigger operating mode button (A) to access either spot, 2T and 4T functions. See page 19 for further information.



Plate thickness dial

When in MIG mode this dial will adjust your MIG welding voltage (shown on the right digital display) rotating the dial will increase or decrease your welding voltage.

When in pulse and synergic MIG mode, pressing and holding the button for 2 seconds allows you to set material plate thickness that's being welded, plate thickness will then be shown in the right display and rotating the dial will adjust material thickness from 0.5mm ~ 10mm. Pressing the button again saves the set material thickness.



When in synergic mode this control dial allows the user to control the voltage/arc length trim, the trim adjustment scale varies from -30 ~ +30 which is shown on the display with the factory suggested starting point being zero.

Synergic mode

The synergic option can then be selected if required by pressing the button (B) to make the synergic programs effective. This will give you the ability to adjust one control which in turn adjusts the other welding parameters automatically. The synergic indicator will be lit when operating in synergic mode.

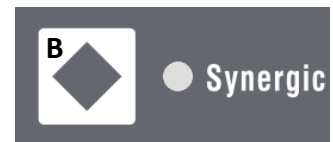

Menu/Wire Feed Speed dial

This control dial is a combined rotary encoder and selection push button which when rotated in MIG mode gives the operator the ability to control wire feed speed in MIG (* factory default setting is wire feed speed).

You can also access the secondary menu from this dial by pressing and holding the knob for 2 seconds, for further information on the secondary menu features, please see page 17 on these options.



* The factory setting for this control dial in MIG mode is set to wire feed speed adjustment (C). To change this function to control and show welding amperage rather than wire feed speed please contact your supplier for further details.

OPERATION - MIG



Before starting any welding activity ensure that you have suitable eye protection and protective clothing. Also take the necessary steps to protect any persons within the welding area.

MIG/MAG standard or pulse welding mode (continued)

MIG welding parameters

Depending on your welding procedure or application, further welding parameter can be selected by scrolling through the MIG adjustable procedure parameters for conventional MIG and pulse MIG modes as follows: Gas pre-flow, initial current parameters, upslope time, peak welding current, downslope time, arc stopping current and post-flow gas time by pressing the parameter selection button (A)

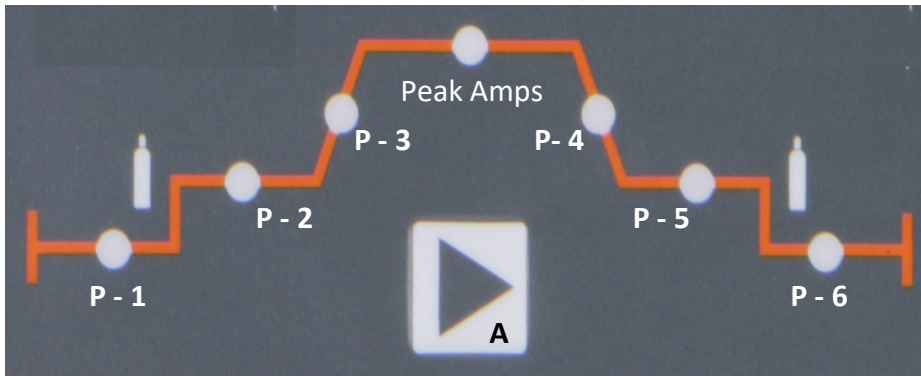

The corresponding indicators will be lit according to the selected parameters and the variable setting is noted on the left digital display and the adjustable values are shown on the right displays which are adjusted using the right control dial.

Parameter	Left display	Parameter range (right display)	Factory default
Gas pre-flow time	P - 1	0.1 ~ 10 seconds	0.5
Initial current	P - 2	40 to 250* amps	40
Upslope time	P - 3	0.1 to 5 seconds	0.1
Peak welding current	--	30 to 250** amps	--
Downslope time	P - 4	0.1 to 5 seconds	0.1
Arc stopping current	P - 5	40 to 250* amps	40
Post-flow gas	P - 6	0.1 to 10 seconds	2

* subject to wire size being used

** subject to wire size and material thickness of material

For further information and guidance on MIG welding please follow the MIG welding guide on page 35.

SET-UP GUIDE

STANDARD MIG/MAG

For standard MIG/MAG welding, set up as below and select 2T/4T trigger mode dependant on user requirements. Material type and wire size selection will have no effect in standard MIG/MAG mode.



The parameter selection button (H) allows you to scroll through the adjustable parameters for conventional MIG/MAG as follows:

- A. P-1: Gas pre-flow time (2T/4T)
- B. P-2: Initial parameters (4T only)
- C. P-3: Upslope time (4T only)
- D. - Peak welding parameters
- E. P-4: Downslope time (4T only)
- F. P-5: Final parameter (4T only)
- G. P-6: Post-flow time (2T/4T)
- H. - Parameter selection button

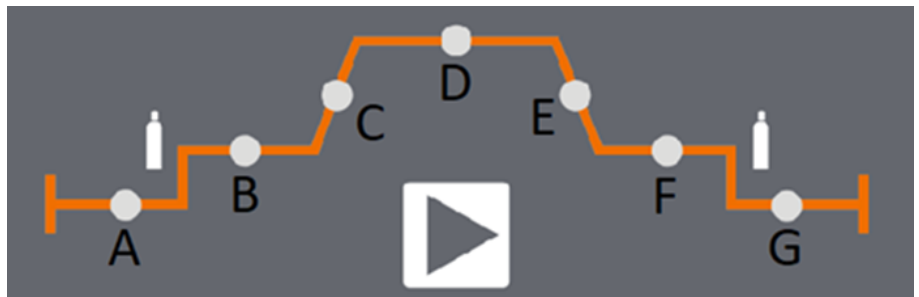

The corresponding indicators will be lit according to selected parameters, the variable setting is noted in the left display and the adjustable values are shown on the right displays which are adjusted using the right control dial. However; INITIAL, PEAK and FINAL parameters are adjusted using the corresponding display control dial for wire feed speed and voltage.

Parameter	Units	Adjustable Range	Guide Setting	Notes
Job/Material	---	---	---	---
A. PRE-GAS TIME	Seconds	0.0 ~ 10	0.5	
B. INITIAL Parameter	WFS V	3-15m/min 9.0-36.0V	Match PEAK parameter	Adjustment only available in "4T" mode
C. UP-SLOPE TIME	Seconds	0.1 ~ 5	0.1	Adjustment only available in "4T" mode
D. PEAK Parameter	WFS V	3-15m/min 9.0-36.0V	User defined *	
E. DOWN-SLOPE TIME	Seconds	0.1 ~ 5	0.1	Adjustment only available in "4T" mode
F. FINAL Parameter	WFS V	3-15m/min 9.0-36.0V	Match PEAK parameter	Adjustment only available in "4T" mode
G. POST-GAS TIME	Seconds	0.1~ 10	2.0	

SET-UP GUIDE

STANDARD (SYNERGIC) MIG/MAG

For Standard (Synergic) MIG/MAG welding, set up as below and ensure you have “Synergic” mode Selected. 2T/4T trigger modes can be selected dependant on user requirements.



The parameter selection button (H) allows you to scroll through the adjustable parameters for Standard Synergic MIG/MAG as follows:

- A. P-1: Gas pre-flow time (2T/4T)
- B. P-2: Initial parameters (4T only)
- C. P-3: Upslope time (4T only)
- D. - Peak welding parameters
- E. P-4: Downslope time (4T only)
- F. P-5: Final parameter (4T only)
- G. P-6: Post-flow time (2T/4T)
- H. - Parameter selection button

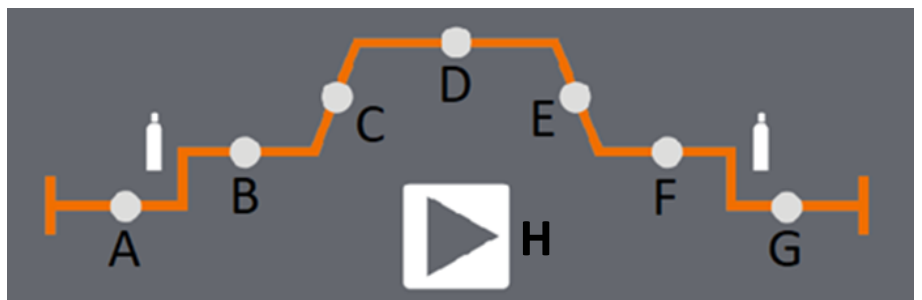

The corresponding indicators will be lit according to selected parameters, the variable setting is noted in the left display and the adjustable values are shown on the right displays which are adjusted using the right control dial.

Material Thickness Adjustment

In synergic mode “D. - Peak welding parameters” can be adjusted based on material thickness, this is done by;



Press and holding in the right hand dial until the display changes to material thickness (as above). You can then release the dial and select the thickness of material you are welding by rotating the same dial.

To exit this mode simply press and hold the dial in again to revert back to the original display.

Please Note: The synergic settings are a guide only and dependent on your application adjustments may be required to achieve the desired welding characteristics.

SET-UP GUIDE

STANDARD (SYNERGIC) MIG/MAG

Voltage Trim Adjustment

Trim adjustment should be set to 0.0 to start with and adjusted based on user requirements, this is done by rotating the right hand dial when the machine is not in material thickness selection;

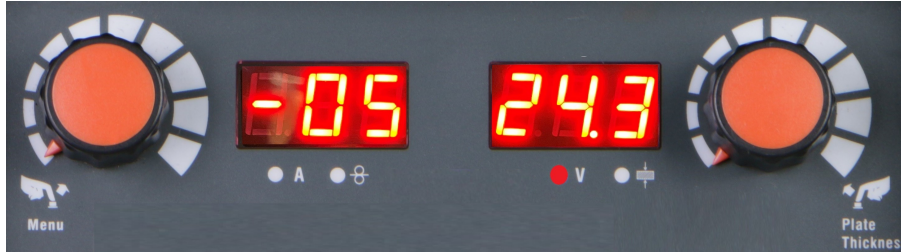

- Adjusting the trim up from 0.0 to 30 will increase the heat input into the material and give you the effect of having less wire and a longer welding arc.
- Adjusting the trim down from 0.0 to -30 will reduce the heat input into the material and give you the effect of having more wire and a shorter welding arc.

Quick set up parameters

Use the below guide setting parameter chart to help set up your machine

Parameter	Units	Adjustable Range	Guide Setting	Notes
Job/Material	---	Fe, St, AlSi, AlMg	User defined *	Set to the type of material you are welding
A. PRE-GAS TIME	Seconds	0.1 ~ 10	0.5	
B. INITIAL Parameter	WFS V	3-15m/min	Match PEAK setting	Adjustment only available in "4T" mode
C. UP-SLOPE TIME	Seconds	0.1 ~ 5	0.1	Adjustment only available in "4T" mode
D. PEAK Parameter	WFS V	0.5-10mm	User defined *	Set to thickness of material you are welding (thickness in "mm")
E. DOWN-SLOPE TIME	Seconds	0.1 ~ 5	0.1	Adjustment only available in "4T" mode
F. FINAL Parameter	WFS V	3-15m/min 9.0-36.0V	Match PEAK setting	Adjustment only available in "4T" mode
G. POST-GAS TIME	Seconds	0.1~ 10	2.0	

SET-UP GUIDE

SYNERGIC PULSE MIG/MAG

For Synergic Pulse MIG/MAG welding, set up as below and ensure you have 'Synergic' mode selected. 2T/4T trigger modes can be selected dependant on user requirements.



The parameter selection button (H) allows you to scroll through the adjustable parameters for Synergic Pulse MIG/MAG as follows:

- A. P-1: Gas pre-flow time (2T/4T)
- B. P-2: Initial parameters (4T only)
- C. P-3: Upslope time (4T only)
- D. - Peak welding parameter
- E. P-4: Downslope time (4T only)
- F. P-5: Final parameter (4T only)
- G. P-6: Post-flow time (2T/4T)
- H. - Parameter selection button

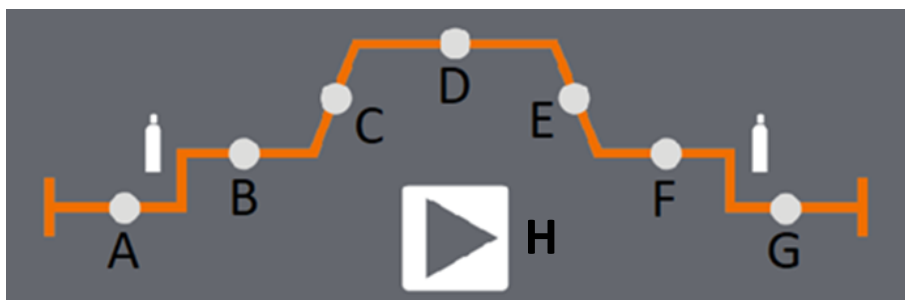

The corresponding indicators will be lit according to selected parameters, the variable setting is noted in the left display and the adjustable values are shown on the right displays which are adjusted using the right control dial.

Material Thickness Adjustment

In synergic mode "D. - Peak welding parameters" can be adjusted based on material thickness, this is done by;



1. Press and holding in the right hand dial until the display changes to material thickness (*as above*).
2. You can then release the dial and select the thickness of material you are welding by rotating the same dial.
3. To exit this mode simply press and hold the dial in again to revert back to the original display.

Please Note: The synergic settings are a guide only and dependent on your application adjustments may be required to achieve the desired welding characteristics.

SET-UP GUIDE

SYNERGIC PULSE MIG/MAG

Voltage Trim Adjustment

Trim adjustment should be set to 0.0 to start with and adjusted based on user requirements, this is done by rotating the right hand dial when the machine is not in material thickness selection;

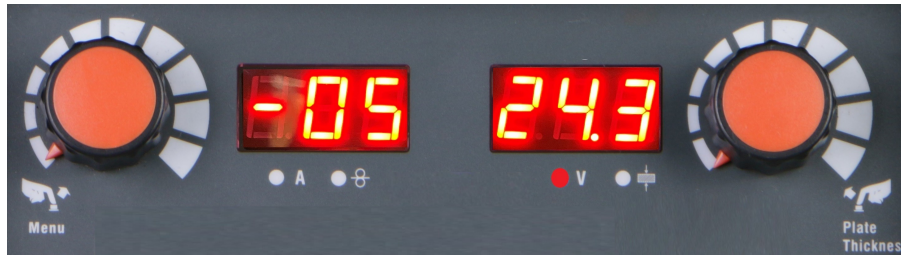

- Adjusting the trim up from 0.0 to 30 will increase the heat input into the material and give you the effect of having less wire and a longer welding arc.
- Adjusting the trim down from 0.0 to -30 will reduce the heat input into the material and give you the effect of having more wire and a shorter welding arc.

Quick set up parameters

Use the below guide setting parameter chart to help set up your machine

Parameter	Units	Adjustable Range	Guide Setting	Notes
Job/Material	---	Fe, St, AlSi, AlMg	User defined *	Set to the type of material you are welding
A. PRE-GAS TIME	Seconds	0.1 ~ 10	0.5	
B. INITIAL Parameter	WFS V	3-15m/min	Match PEAK setting	Adjustment only available in "4T" mode
C. UP-SLOPE TIME	Seconds	0.1 ~ 5	0.1	Adjustment only available in "4T" mode
D. PEAK Parameter	WFS V	0.5-10mm	User defined *	Set to thickness of material you are welding (thickness in "mm")
E. DOWN-SLOPE TIME	Seconds	0.1 ~ 5	0.1	Adjustment only available in "4T" mode
F. FINAL Parameter	WFS V	3-15m/min 9.0-36.0V	Match PEAK setting	Adjustment only available in "4T" mode
G. POST-GAS TIME	Seconds	0.1~ 10	2.0	

GUIDE TO MIG/MAG WELDING



Before starting any welding activity ensure that you have suitable eye protection and protective clothing. Also take the necessary steps to protect any persons within the welding area.

Notes for the welding beginner

This section is designed to give the beginner who has not yet done any welding some information to get them going. The simplest way to start is to practice by running weld beads on a piece of scrap plate. Start by using mild steel (paint free) plate of 6.0mm thick and using 0.8mm wire. Clean any grease, oil and loose scale from the plate and fix firmly to your work bench so that welding can be carried out .

Make sure that the work return clamp is secure and making good electrical contact with the mild steel plate, either directly or through the work table. For best results always clamp the work lead directly to the material being welded, otherwise a poor electrical circuit may create itself.

MIG/MAG process features and benefits

Terms used: MIG - Metal Inert Gas Welding
MAG - Metal Active Gas Welding
GMAW - Gas Metal Arc Welding

MIG welding was developed to help meet production demands of the war and post war economy which is an arc welding process in which a continuous solid wire electrode is fed through a MIG welding gun and into the weld pool, joining the two base materials together. A shielding gas is also sent through the MIG welding gun and protects the weld pool from contamination which also enhances the arc.

The MIG/MAG process can be used to weld a wide variety of materials and is normally used in the horizontal position but can be used in vertical or overhead with the correct selection of machine, wires and current. In addition, it can be used to weld at long distances from the power source subject to the correct cable sizing.

It is the dominant process used in maintenance and repair industries and is used extensively in structural and fabrication work.

Weld quality is also highly dependent on the skill of the operator and many welding problems can exist due to incorrect installation application and use.

Welding position

When welding, ensure you place yourself in a comfortable position for welding and your welding application before you begin to weld. This maybe by sitting at a suitable height which often is the best way to weld ensuring you're relaxed and not tense. A relaxed posture will ensure the welding task becomes much easier.

Please ensure you always wear suitable PPE and use suitable fume extraction when welding.

Place the work so that the direction of welding is across, rather than to or from your body. The electrode holder lead should always be clear of any obstruction so that you can move your arm freely along as the electrode burns down. Some elders prefer to have the welding lead over their shoulder, this allows greater freedom of movement and can reduce the weight from your hand.

Always inspect your welding equipment, welding cables and electrode holder before each use to ensure it is not faulty or worn as you may be at risk of an electric shock.

GUIDE TO MIG/MAG WELDING



Before starting any welding activity ensure that you have suitable eye protection and protective clothing. Also take the necessary steps to protect any persons within the welding area.

MIG process description

The MIG process was first patented for the welding of aluminium in 1949 in the USA.

The process uses the heat that is generated by an electric arc formed between a bare consumable wire electrode and the work piece.

This arc is shielded by a gas to prevent oxidation of the weld.

In the MIG process an inert shielding gas is used to protect the electrode and weld pool from contamination and enhance the arc. Originally this gas was helium.

In the early 1950's the process became popular in the UK for welding aluminium using argon as the shielding gas.

Development in the use of different gases resulted in the MAG process. This is where other gases were used, for example, carbon dioxide and sometimes users refer to this process as CO² welding. Gases such as oxygen and carbon dioxide were added and are active constituents to the inert gas to improve the welding performance. Although the MAG process is in common use today it is still referred to as MIG welding although technically this is not correct. The process began to prove itself as an alternative to stick electrode (MMA) and TIG (GTAW) offering high productivity and deposition rates. The process also helps reduce any weld defects from the increased stop/starts used in MMA. However, the welder must have a good knowledge of the system set up and maintenance to achieve satisfactory welds.

The electrode MIG gun is normally +VE and the work return is normally -VE. However, certain consumable wires sometimes require what is called reverse polarity i.e. Electrode -VE or work +VE. Typically these types of wire are cored wires used in hard facing or high deposition and gasless applications.

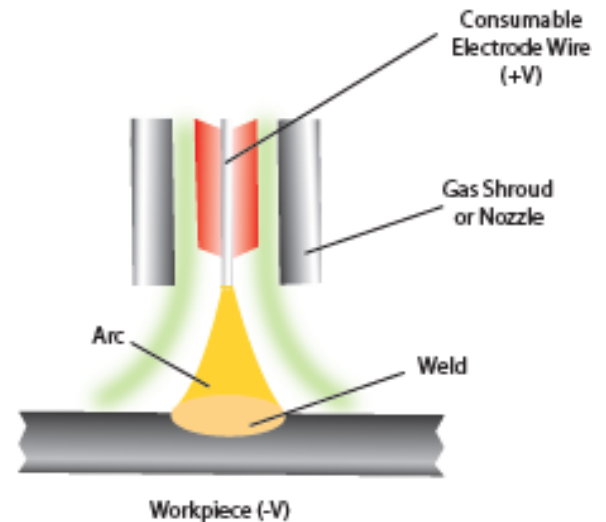

Typical welding ranges

Wire Diameter (mm)	DIP Transfer		Spray Transfer	
	Current (A)	Voltage (V)	Current (A)	Voltage (V)
0.6	30 ~ 80	15 ~ 18	n/a	n/a
0.8	45 ~ 180	16 ~ 21	150 ~ 250	25 ~ 33
1.0	70 ~ 180	17 ~ 22	230 ~ 300	26 ~ 35
1.2	60 ~ 200	17 ~ 22	250 ~ 400	27 ~ 35
1.6	100 ~ 280	18 ~ 22	250 ~ 500	30 ~ 40

GUIDE TO MIG/MAG WELDING



Before starting any welding activity ensure that you have suitable eye protection and protective clothing. Also take the necessary steps to protect any persons within the welding area.

MIG controls

The main basic controls for the MIG/MAG system are as follows. Controls can be electro mechanical or electronic but the effects will be the same.

Wire feed speed

The wire speed is directly related to the current. The higher the wire speed the more wire is deposited and hence more current is required to burn off the consumable wire.

Wire speed is measured in m/min (metres per min) or sometimes in ipm (inches per minute).

The diameter of the wire also forms part of the current demand e.g. a 1.0mm wire feeding at 3m per minute will require less current than a 1.2mm wire feeding at the same rate.

The wire feed is set according to the material to be welded.

If the wire feed rate is too high in comparison to the voltage then a “stubby” effect happens where un-melted consumable contacts the work piece creating large amounts of weld spatter.

Too little wire feed comparison to the voltage will result in a long arc being created with poor transfer and eventual burning back of the welding wire onto the contact tip.

Please Note: The JM-250P machine default display (2) is wire feed speed, to show amperage and not WFS please see page 23.

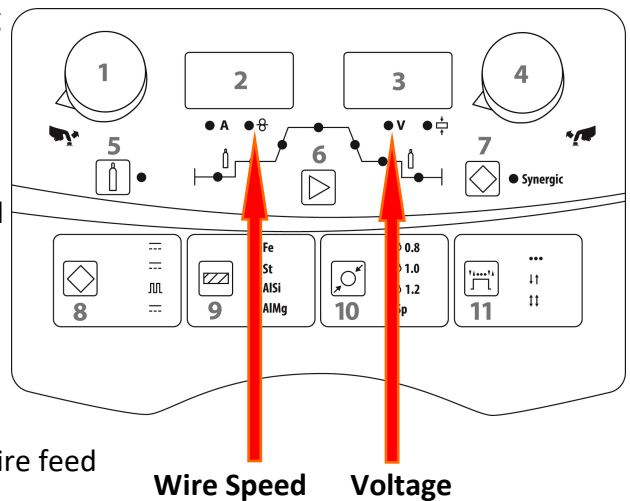

Voltage setting

The voltage polarity in MIG/MAG welding is in the majority of cases with the positive (+). This means that the majority of the heat is in the electrode wire. Certain special wires may require the polarity to be reversed i.e. electrode wire negative (-) polarity.

Always consult the manufacturer's data sheet for the best operating parameters.

The voltage is often referred to as the “heat setting”. This will be altered dependent on the material type, thickness, gas type, joint type and position of the weld. Combined with the wire speed it is the main control adjusted by the welder. The voltage setting varies depending on the type and size of electrode wire being used.

Most MIG/MAG welders are CV (Constant Voltage) power sources which means the voltage does not vary much during welding. Modern inverter power sources also have control circuits to monitor conditions to ensure voltage remains constant.

The voltage determines height and width of the weld bead. If the operator has no reference to settings required the best method of set up is to use scrap material of the same thickness to obtain the correct setting. If there is too much voltage the arc will be long and uncontrollable and cause the wire to fuse to the contact tip. If the voltage is too low then there will not be enough heat to melt the wire and then stubbing occurs.

To obtain a satisfactory weld, a balance needs to be made between voltage and wire speed.

Characteristics of the voltage are that the higher voltage produces a flatter and wider weld bead but care must be taken to avoid undercut. The lower the voltage the weld bead becomes narrow and higher.

GUIDE TO MIG/MAG WELDING



Before starting any welding activity ensure that you have suitable eye protection and protective clothing. Also take the necessary steps to protect any persons within the welding area.

Synergic Mode

The synergic button when pressed allows access to the synergic programs, synergic means when a single setting is adjusted i.e. voltage or material thickness then other settings like current or wire speed will also change according. The synergic indicator will be lit when operating in synergic mode and pressing the button again take you out of synergic mode.

Wire inch switch

The wire inch button when pressed and held allows the operating to activate the feed motor which in turn feeds the welding wire through the MIG torch cable, torch head and tip.

Burn back control

In the event that the welder was to stop welding and all functions of the machine stopped simultaneously then the consumable filler wire would in all likelihood freeze in the weld pool. In order to avoid this happening the burn back feature is present on this machine.

The burnback control is used to adjust and set the amount of 'stick out' MIG wire that protrudes from the MIG torch tip after the torch trigger has been released and welding has stopped.

To decrease burnback time (or lengthen the amount of wire sticking out from the MIG torch tip at the end of welding), adjust the burnback control feature anti clockwise.

To increase burnback time (or shorten the amount of wire sticking out from the tip at the end of weld), adjust the burnback control feature clockwise.

Inductance control

Variable inductance control allows you to tune the welding arc to suit your welding application, this is used to minimise spatter and to control the arc from crisp through to soft.

Lowering the inductance is ideal when welding with smaller diameter wires for a crisp stable arc with maximum deposition and minimum heat into the work piece.

Increasing inductance softens the arc giving more penetration, reduces spatter and increases heating of the work piece.

Some quick reference handy tips for the MIG/MAG welding process are:

- When welding, try to use an electrode stick out (the distance between the weld and the contact tip) of around 6-8mm.
- When welding thin materials try and use smaller MIG wire diameters and for thicker materials use thicker wires.
- Make sure you select the correct MIG wire type for the material to be welded.
- Ensure the MIG welding gun has the correct sized contact tip and type of liner.
- Always ensure you have the correct size drive rolls and torch liner for the wire size selected.
- Select the correct gas to achieve the correct weld characteristics and finish.
- For optimum control of the weld keep the wire at the leading edge of the weld pool.
- Before commencing welding, ensure a comfortable and stable position.
- Try to keep the welding torch as straight as possible when welding to ensure the best feed.
- Carry out daily housekeeping on the condition of the welding torch and drive rolls.
- Keep any consumables clean and dry to avoid contamination such as oxidation and damp.

SPOOL GUN OPERATION



Before starting any welding activity ensure that you have suitable eye protection and protective clothing. Also take the necessary steps to protect any persons within the welding area.

Spool Gun Welding Mode

Spool gun part number is TSP-250-P

The Jasic MIG 250P can only be used with our optional spool gun which is a Euro style spool gun that connects to the MIG 250P via the Euro outlet connector.

Connect the spool gun Euro plug to the (MIG) euro socket. Connect the spool gun 9 pin control plug to its matching 9 pin socket located on the front panel of the machine.

Ensure the trailing lead is connected into the “+” socket on the front panel of the machine and tighten clockwise.

Insert the cable plug for the work clamp into the “-” socket on the front panel of the welding machine and tighten clockwise.

Connect the gas hose to the regulator/flowmeter located on the shield gas cylinder and connect the other end to the machine.

Before starting any welding activity ensure that you have suitable eye protection and protective clothing. Also take the necessary steps to protect any persons within the area.

After connecting the welding leads as detailed above you will need to switch the power switch on the back panel to “ON” and select MIG welding mode, you can use the spool gun in standard, pulse or synergic MIG modes.

Set the welding voltage and other parameters via the machine control panel although wire feed speed is adjusted from the wire feed control potentiometer fitted on the spool gun.

Ensure you have adequate welding current according to the thickness of the work and weld prep being carried out.

Fit your 1Kg reel of welding wire to the spool holder and feed the wire through the drive rolls ensuring the fitted roller sizes matches your wire type and size, then continue to feed the wire through the contact tip again ensuring you have the correct size tip fitted.

Open the gas valve of the cylinder, press the torch trigger and adjust the gas regulator to obtain the desired flow rate.

Adjust the “voltage” control knob on the front panel of the machine to set the correct welding voltage and adjust the “wire feed speed” control knob on the spool gun for welding current.

Operate the torch trigger and welding can now be carried out.

Please Note:

The spool gun option can be used in standard and pulse welding modes along with all material choices. Spool gun part number is TSP-250-P



MIG WELDING GUIDE

MIG Set-Up Guide

Please Note: This information is intended to act as a starting point guide only for standard MIG mode

Material	Wire Type	Polarity	Shielding Gas (20-30 CFH Flow Rate)	Wire Dia.	0.5mm	0.6mm	0.8mm	1.0mm	1.2mm	1.6mm	3.0mm	4.5mm	6.0mm	6.0mm	8.0mm	10.0mm	
Steel	Solid Wire ER70S-6	DCEP	C25	0.6	15.5/3.2	15.5/3.6	16/4.3	16.5/5.6	17/6.4	17.5/7.8	18/9.7	18.5/10.5	-	-	-	-	
				0.8	15.5/2.3	15.5/2.4	16/2.8	16.5/3.8	17/5.1	17.5/5.7	18.5/6.4	19/7	19.5/7.9	20/8.9	20/8.9	21.5/10.5	
				1.0	15.5/1.8	15.5/2	16/2	16.5/2.8	17/3.6	17.5/4.2	18.5/4.5	19.5/5.1	19.5/7.9	20/5.7	20/5.7	21/7.6	
	Flux-Cored E71T-11	DCEN	-	0.6	16.5/3.2	16.5/3.6	17/4.3	18/5.6	18.5/6.4	18.5/6.4	19/8.6	19.5/9.9	20/10.5	-	-	-	-
				0.8	16.5/2.3	16.5/2.4	17/2.8	18/3.8	18.5/5.1	19/5.7	19.5/6.4	20/5.7	22/7.9	23.5/8.6	23.5/8.6	25/9.2	
				1.0	16.5/1.8	16.5/2	17/2	18/2.8	18.5/3.6	20/4.2	21/4.1	22/5.5	22/6	23.5/7	23.5/7	24.5/8	
	Stainless Steel	DCEP	Tri-Mix	0.6	-	18/4.1	18.5/4.6	19/5.6	19.5/6.4	19.5/6.4	20/8.3	21.5/10.2	-	-	-	-	-
				0.8	-	18/2.7	18.5/3.0	19/3.8	19.5/4.1	20/5.1	21.5/6.6	22/8.1	22/9.2	22/9.2	22/9.2	22.5/9.6	23/10.2
				1.0	-	18/2	18.5/2.2	18.5/2.8	19/3.1	19.5/4.1	21/4.8	21.5/5.6	22/6.1	22/6.1	22/6.1	22.5/6.6	23/7
Aluminium	Aluminum ER4043	DCEP	Argon	0.8	-	-	-	13/7.6	14/8.1	14.5/10.2	20/8.9	21/9.3	-	-	-	-	
				1.0	-	-	-	14.5/6.1	16/7.1	17/8.6	20/7.6	22/9.2	22/9.2	23/9.7	23/9.7	-	-

MIG WELDING PROBLEMS



Before starting any welding activity ensure that you have suitable eye protection and protective clothing. Also take the necessary steps to protect any persons within the welding area.

MIG welding defects and prevention methods

<u>Defect</u>	<u>Possible cause</u>	<u>Action</u>
Porosity (within or outside the bead)	Poor material	Check the material is clean
	Insufficient shield gas flow	Check hoses and MIG torch for blockages
	Gas flow too low/high	Check the regulator setting or that it is not frozen due to a high flow
	Leaking hoses	Check all hoses for leaks
	Faulty gas valve	Call a service engineer
Poor or inconsistent wire feed	Working in open area with drafts	Put screens up around the weld area
	Incorrect pressure on wire drive causing burn back to contact tip or bird nesting at the feed roll	Readjust the upper feed pressure
		Increase the pressure to eliminate burn back to tip
		Decrease pressure to eliminate bird nesting
	Damage to torch liner	Replace torch liner
Welding wire contaminated or rusty	Replace wire	
No operation when the torch switch is operated	Worn welding tip	Check and replace welding tip
	Torch switch faulty	Check the torch switch continuity and replace if faulty
	Fuse blown	Check fuses and replace if necessary
Low output current	Faulty PCB inside the equipment	Call a service engineer
	Loose or defective work clamp	Tighten/replace clamp
	Loose cable plug	Re-fix plug
No operation	Power source faulty	Call a service engineer
	No operation and mains lamp not lit	Check mains fuse and replace if required
Excessive spatter	Faulty power source	Call a service engineer
	Wire feed speed too high or welding voltage too low	Reset the parameters according to the weld to be made
Excessive penetration, the weld metal is below the surface level of the material and hangs below	Heat input too high	Reduce the amperage or use a smaller electrode and lower amperage
	Poor weld technique	Use correct welding travel speed

MIG WELDING PROBLEMS



Before starting any welding activity ensure that you have suitable eye protection and protective clothing. Also take the necessary steps to protect any persons within the welding area.

MIG welding defects and prevention methods

<u>Defect</u>	<u>Possible cause</u>	<u>Action</u>
Burning through – Holes within the material where no weld exists	Heat input too high	Use lower amperage or smaller electrode Use correct welding travel speed
Poor fusion – Failing of weld material to fuse either with the material to be welded or previous weld beads	Insufficient heat level Poor welding technique Work piece dirty	Increase the amperage or increase the electrode size and amperage Joint design must allow for full access to the root of the weld Alter welding technique to ensure penetration such as weaving, arc positioning or stringer bead technique Remove all contaminant from the material i.e. oil, grease, rust, moisture prior to welding
Irregular weld bead and shape	Incorrect voltage/wire feed settings If it's convex, voltage is too low and if it's concave then voltage is too high. Insufficient or excessive heat input Wire is wandering Incorrect shielding gas	Adjust voltage and/or wire feed speed Adjust the wire feed speed dial or the voltage control Replace contact tip Check and change the shielding gas as required
Your weld is cracking	The weld beads too small Weld penetration narrow and deep Excessive voltage Weld/material cooling rate too fast	Try decreasing the travel speed Try reducing the wire feed speed current and voltage or increase MIG torch travel speed Decrease voltage control dial Slow the cooling rate by preheating part to be welded or cool slowly
The welding arc does not have a crisp sound that short arc exhibits when the wire feed speed or voltage are adjusted correctly.	The MIG torch may have been connected to the wrong output voltage polarity on the front panel	Ensure that the MIG torch polarity lead is connected to the positive (+) welding terminal for solid wires and gas shielded flux cored wires

JM-250P MIG TORCH SPARE PARTS LIST

MIG Welding Torch Air Cooled - Model: T250

T250 Rating 230A Co2 / 200A Mixed Gases @ 60% Duty Cycle EN60974-7 Wire Size 0.8mm to 1.2mm



Torch Packages

T250-3 T250-4 T250-5
3 metre 4 metre 5 metre
*Euro Fitting and Bladeswitch

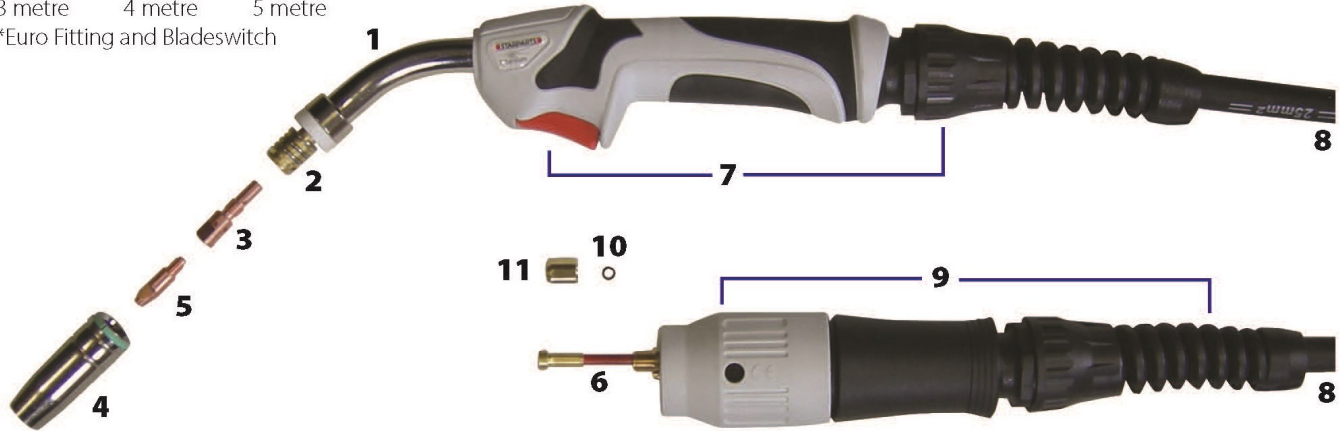

Main Consumables

	Code	Description	Pack Qty
1	SP2554	Swan Neck Complete	1
2	SP2557	Shroud Spring	10
3	SP2581	Tip Adaptor M6 Tips	5
	SP2582 *	Tip Adaptor M8 Tips	5
4	SP2570	Nozzle Conical	5
	SP2571	Nozzle Cylindrical	5
	SP2572	Nozzle Tapered	5
	SP2574	Spot Welding Nozzle	5

Contact Tips (ECU M6 x 28mm)

5	SP2408	0.8mm Steel / 0.6mm Alum Wire	25
	SP2409	0.9mm Steel Wire	25
	SP2410	1.0mm Steel / 0.8mm Alum Wire	25
	SP2412	1.2mm Steel / 1.0mm Alum Wire	25

* For specifically marked ALU Tips add 'A' after the part number eg: SP2410A

Contact Tips (CuCrZr M6 x 28mm)

	SP2508	0.8mm Steel / 0.6mm Alum Wire	25
	SP2509	0.9mm Steel Wire	25
	SP2510	1.0mm Steel / 0.8mm Alum Wire	25
	SP2512	1.2mm Steel / 1.0mm Alum Wire	25

Liners (Steel Plastic Coated)

	Code	Description	Pack Qty
6	SP1539	0.6 - 0.9mm x 3m - PC Blue	1
	SP1549	0.6 - 0.9mm x 4m - PC Blue	1
	SP1559	0.6 - 0.9mm x 5m - PC Blue	1
	SP2432	1.0 - 1.2mm x 3m - PC Red	1
	SP2442	1.0 - 1.2mm x 4m - PC Red	1
	SP2452	1.0 - 1.2mm x 5m - PC Red	1

Liners (PTFE)

	SP1538T	0.6 - 0.8mm x 3m - PC Blue	1
	SP1548T	0.6 - 0.8mm x 4m - PC Blue	1
	SP1558T	0.6 - 0.8mm x 5m - PC Blue	1
	SP2432T	1.0 - 1.2mm x 3m - PC Red	1
	SP2442T	1.0 - 1.2mm x 4m - PC Red	1
	SP2452T	1.0 - 1.2mm x 5m - PC Red	1
	SP1511	Liner Collet	5
	SP1517	Liner 'O' Ring	10

Secondary Consumables

7	SP1625	Complete Bladeswitch Handle c/w Cable Support	1
8	SP2403	Cable Assy 3m	1
	SP2404	Cable Assy 4m	1
	SP2405	Cable Assy 5m	1
9	SP8003	Complete Euro Connection Kit c/w Support	1
10	SP1596	Gun Plug 'O' Ring	10
11	SP1597	Liner Retaining Nut	5

* For 8mm Threaded Tips Use SP38 / SP40 Series See Page 194 Item No. 6

OPERATION - MMA



Before starting any welding activity ensure that you have suitable eye protection and protective clothing. Also take the necessary steps to protect any persons within the welding area.

MMA welding mode

MMA (Manual Metal Arc), SMAW (Shielded Metal Arc Welding) or just Stick Welding.

Stick welding is an arc welding process which melts and joins metals by heating them with an arc between a covered metal electrode and the work.

Shielding is obtained from the electrode outer coating, often called flux. Filler metal is primarily obtained from the electrode core.

The electrodes outer coating called flux assists in creating the arc and provides a shielding gas and on cooling forms a slag covering to protect the weld from contamination.

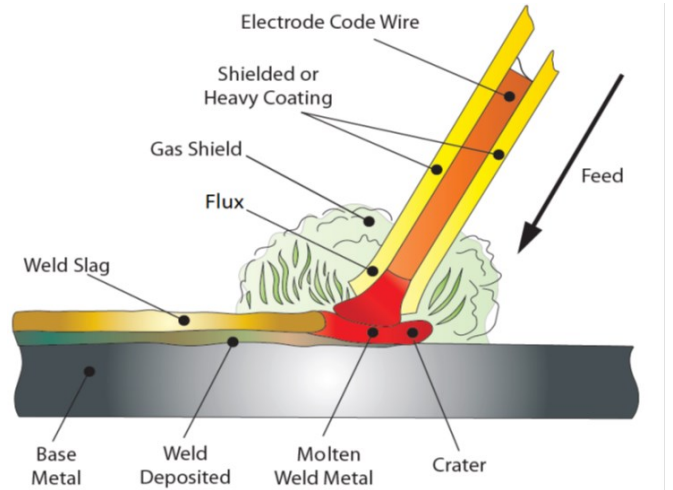

When the electrode is moved along the work piece at the correct speed the metal core deposits a uniform layer called the weld bead.

After connecting the welding leads as detailed you will need to switch the power switch on the back panel to "ON".

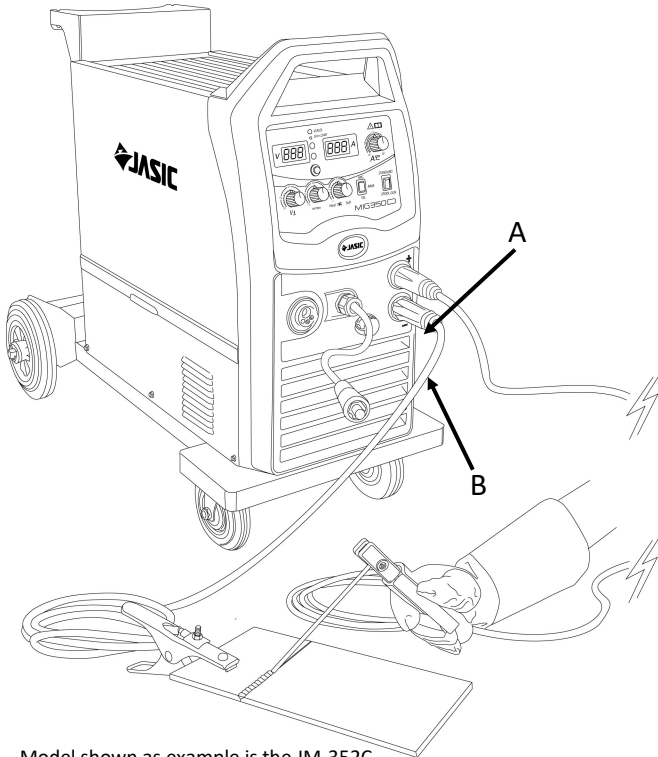

Model shown as example is the JM-352C

Please refer to a guide for MMA amperages required although the below MMA welding electrode guide can vary depending on material, work piece thickness, welding position and joint form.

Select MMA by pressing the TIG/MIG/MMA button to MMA welding mode.



If required turn ON VRD by pressing the trigger/spot button.



There is now open circuit voltage output at both output terminals.

Ensure you check that you have the electrode polarity correct for MMA welding. Electrode holder into the "+" socket (A) and the work return lead into the "-" socket (B) on the front panel of the welding machine.

Set the welding amperage desired by rotating either the left or right control dials suitable for the electrode being used.

Electrode Diameter (mm)	Recommended Welding Current (A)
1.6	25 ~ 45
2.0	35 ~ 65
2.5	50 ~ 90
3.2	60 ~ 130
4.0	100 ~ 180
5.0	150 ~ 250
6.0	200 ~ 310

GUIDE TO MMA WELDING



Before starting any welding activity ensure that you have suitable eye protection and protective clothing. Also take the necessary steps to protect any persons within the welding area.

Notes for the welding beginner

This section is designed to give the beginner who has not yet done any welding some information to get them going. The simplest way to start is to practice by running weld beads on a piece of scrap plate. Start by using mild steel (paint free) plate of 6.0mm thick and using 3.2mm electrodes. Clean any grease, oil and loose scale from the plate and fix firmly to your work bench so that welding can be carried out. Make sure that the work return clamp is secure and making good electrical contact with the mild steel plate, either directly or through the work table. For best results always clamp the work lead directly to the material being welding, otherwise a poor electrical circuit may create itself.

Welding position

When welding, ensure you place yourself in a comfortable position for welding and your welding application before you begin to weld. This maybe by sitting at a suitable height which often is the best way to weld ensuring you're relaxed and not tense. A relaxed posture will ensure the welding task becomes much easier.

Please ensure you always wear suitable PPE and use suitable fume extraction when welding.

Place the work so that the direction of welding is across, rather than to or from your body. The electrode holder lead should always be clear of any obstruction so that you can move your arm freely along as the electrode burns down. Some elders prefer to have the welding lead over their shoulder, this allows greater freedom of movement and can reduce the weight from your hand.

Always inspect your welding equipment, welding cables and electrode holder before each use to ensure it is not faulty or worn as you may be at risk of an electric shock.

MMA process features and benefits

The versatility of the process and the skill level required to learn, basic simplicity of the equipment make the MMA process one of the most common used throughout the world.

The MMA process can be used to weld a wide variety of materials and is normally used in the horizontal position but can be used in vertical or overhead with the correct selection of electrode and current. In addition, it can be used to weld at long distances from the power source subject to the correct cable sizing. The self shielding effect of the electrode coating makes the process suitable for welding in external environments. It is the dominant process used in maintenance and repair industries and is used extensively in structural and fabrication work.

The process is well able to cope with less than ideal material conditions such as dirty or rusty material. Disadvantages of the process are the short welds, slag removal and stop starts which lead to poor weld efficiency which is in the region of 25%. The weld quality is also highly dependent on the skill of the operator and many welding problems can exist.

GUIDE TO MMA WELDING



Before starting any welding activity ensure that you have suitable eye protection and protective clothing. Also take the necessary steps to protect any persons within the welding area.

MMA process tips and guides

Typical welder set up

1. Electrode holder
2. Work return clamp
3. Work piece
4. Weld material covered by electrode flux or slag
5. Electrode
6. Distance from work to electrode (arc length)

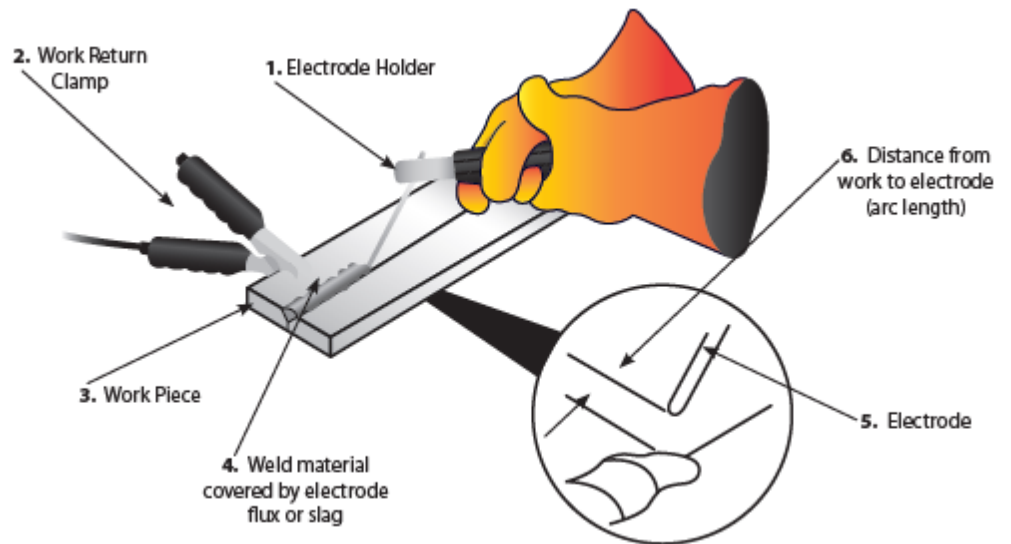

Welding current will flow in the circuit as soon as the electrode contacts the work piece. The welder should always ensure a good connection of the work clamp. The nearer the clamp is placed to the welding area the better.

When the arc is struck the distance between the end of the electrode and the work will determine the arc voltage and also affect the weld characteristic. As a guide the arc length for electrodes up to 3.2mm diameter should be around 1.6mm and over 3.2mm around 3mm.

Upon completion of the weld the welding flux or slag will need to be removed usually with a chipping hammer and wire brush.

Joint form in MMA

In MMA welding, the common basic joint forms: butt joint, corner joint, lap joint and T joint.

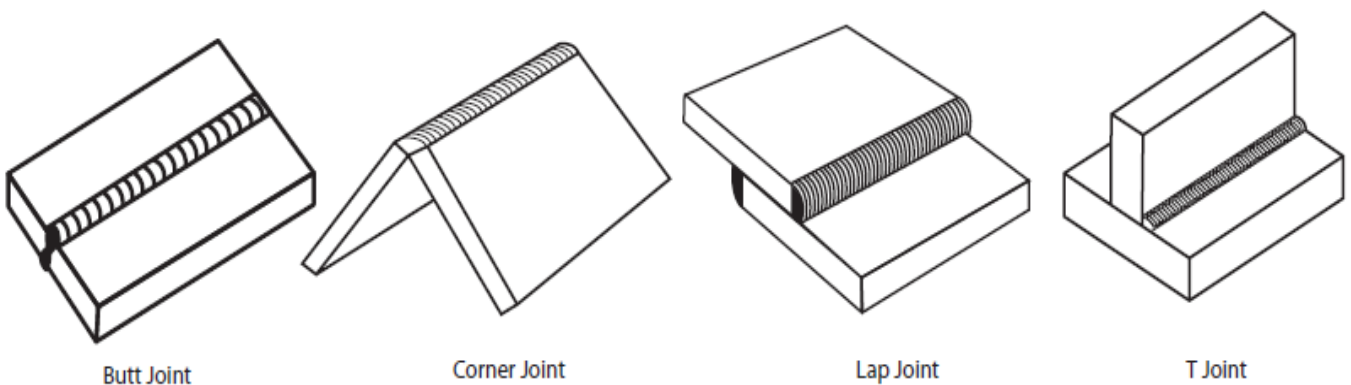

GUIDE TO MMA WELDING



Before starting any welding activity ensure that you have suitable eye protection and protective clothing. Also take the necessary steps to protect any persons within the welding area.

MMA arc striking

Tap technique - Lift the electrode upright and bring it down to strike the work piece. After forming short circuit, quickly lift up about 2~4mm and arc will be ignited. This method is difficult to master.

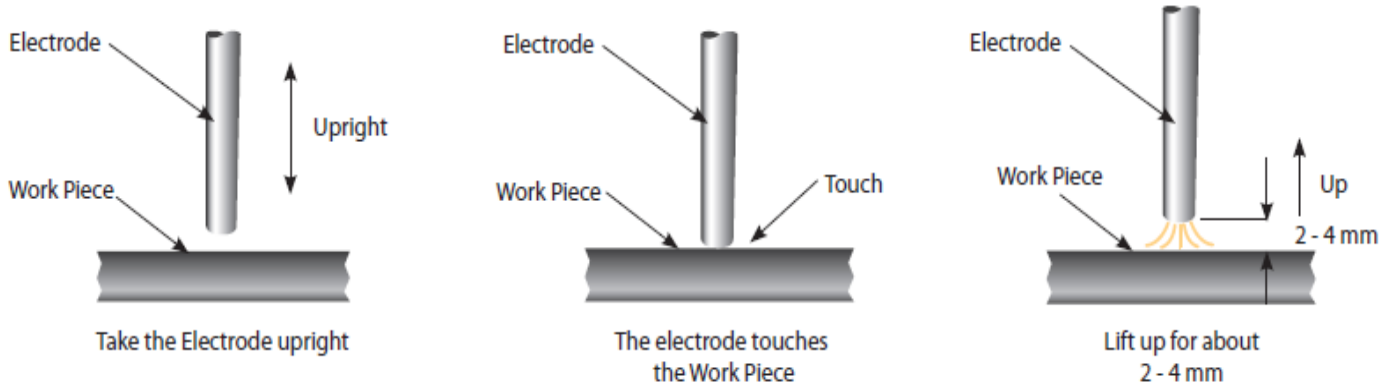

Scratch technique - Drag the electrode and scratch the work piece as if striking a match. Scratching the electrode may cause the arc to burn along the scratch path, so care should be taken to scratch in the weld zone. When the arc is struck adopt the correct welding position.

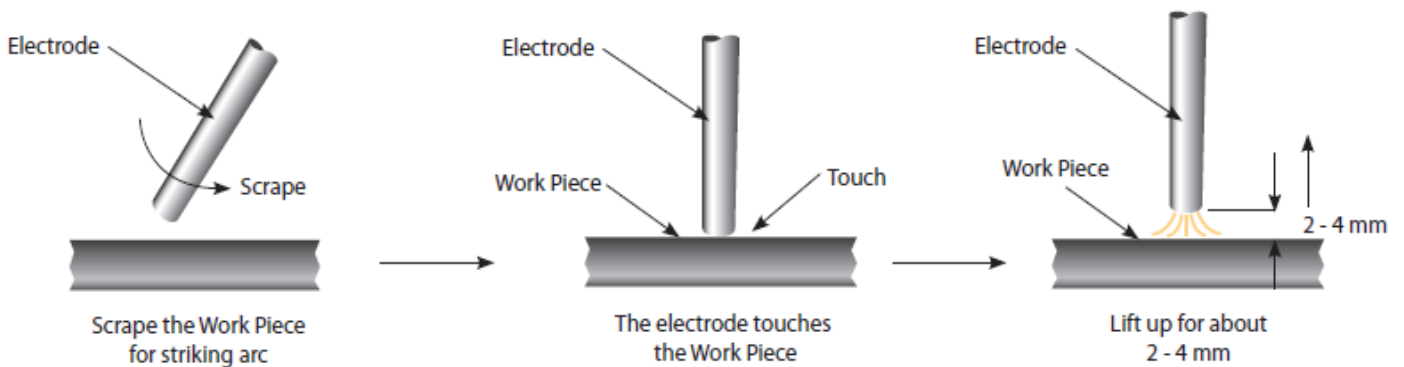

Electrode positioning

Horizontal or flat position

The electrode should be positioned at right angles to the plate and inclined in the direction of travel at around 10°-30°.

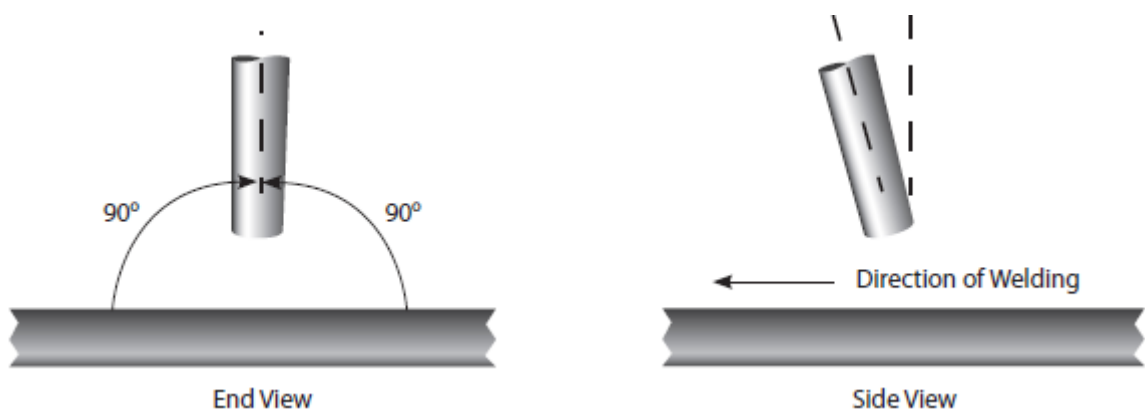

GUIDE TO MMA WELDING



Before starting any welding activity ensure that you have suitable eye protection and protective clothing. Also take the necessary steps to protect any persons within the welding area.

Fillet welding

The electrode should be positioned to split the angle i.e. 45° . Again the electrode should be inclined in the direction of travel at around 10° - 30° .

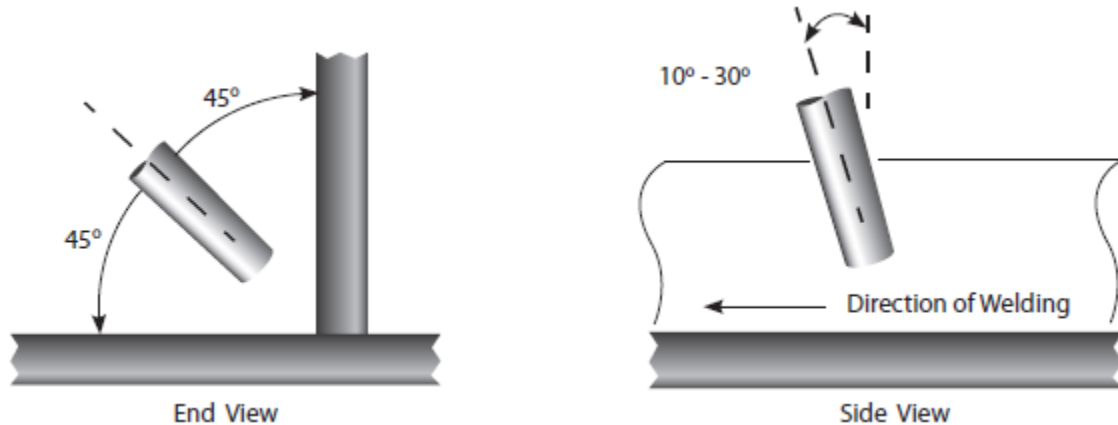

Manipulation of electrode

In MMA welding there are three motions used at the end of electrode:

1. The electrode feeding to the molten pool along axis
2. The electrode swing right and left
3. The electrode moving in the weld direction

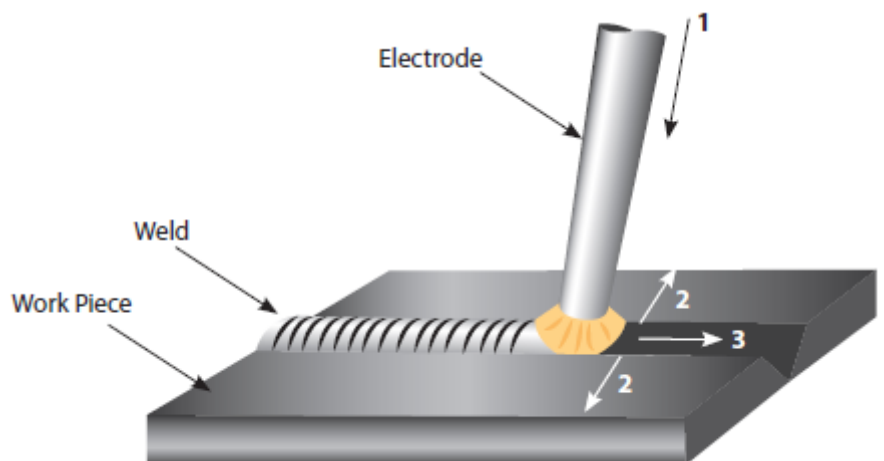

The operator can choose the manipulation of electrode based on welding joint, welding position, electrode spec, welding current and operation skill etc.

Weld characteristics

A good weld bead should exhibit the following characteristics:

1. Uniform weld bead
2. Good penetration into the base material
3. No overlap
4. Fine spatter level

A poor weld bead should exhibit the following characteristics:

1. Uneven and erratic bead
2. Poor penetration into the base material
3. Bad overlap
4. Excessive spatter levels
5. Weld crater

MMA WELDING PROBLEMS



Before starting any welding activity ensure that you have suitable eye protection and protective clothing. Also take the necessary steps to protect any persons within the welding area.

Arc welding defects and prevention methods

<u>Defect</u>	<u>Possible cause</u>	<u>Action</u>
Excessive spatter (beads of metal scattered around the weld area)	Amperage too high for the selected electrode	Reduce amperage or utilise larger diameter electrode
	Voltage too high or arc length too long	Reduce arc length or voltage
Uneven and erratic weld bead and direction	Weld bead is inconsistent and misses joint due to operator	Operator training required
Lack of penetration - The weld bead fails to create complete fusion between material to be welded, often surface appears okay but weld depth is shallow	Poor joint preparation	Joint design must allow for full access to the root of the weld
	Insufficient heat input	Material too thick Increase the amperage or increase the electrode size and amperage
	Poor weld technique	Reduce travel speed Ensure the arc is on the leading edge of the weld puddle
Porosity - Small holes or cavities on the surface or within the weld material	Work piece dirty	Remove all contaminant from the material i.e. oil, grease, rust, moisture prior to welding
	Electrode is damp	Replace or dry the electrode
	Arc length is excessive	Reduce the arc length
Excessive penetration - The weld metal is below the surface level of the material and hangs below	Heat input too high	Reduce the amperage or use a smaller electrode and lower amperage
	Poor weld technique	Use correct welding travel speed
Burning through - Holes within the material where no weld exists	Heat input too high	Use lower amperage or smaller electrode Use correct welding travel speed
Poor fusion - Failing of weld material to fuse either with the material to be welded or previous weld beads	Insufficient heat level	Increase the amperage or increase the electrode size and amperage
	Poor welding technique	Joint design must allow for full access to the root of the weld Alter welding technique to ensure penetration such as weaving, arc positioning or stringer bead technique
	Work piece dirty	Remove all contaminant from the material i.e. oil, grease, rust, moisture prior to welding

OPERATION - TIG



Before starting any welding activity ensure that you have suitable eye protection and protective clothing. Also take the necessary steps to protect any persons within the welding area.

TIG welding mode

Terms used: TIG – Tungsten Inert Gas, GTAW – Gas Tungsten Arc Welding.

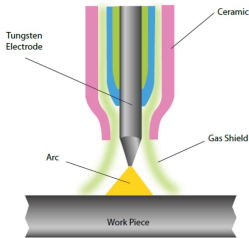

TIG welding is an arc welding process that uses a non-consumable tungsten electrode to produce the heat for welding.

The weld area is protected from atmospheric contamination by a shielding gas (usually an inert gas such as argon or helium) and a filler rod matching the base material is normally used, though some welds, known as autogenous welds, are carried out without the need for filler wire.

Please Note: The Jasic JM-250P uses a Euro style TIG torch when being used in Lift TIG mode. See options page 59 for relevant part numbers.

Insert the dinse cable plug of the trailing cable into the “-” socket on the front panel of the machine and fully tighten clockwise.

Insert the dinse cable plug for the work clamp into the “+” socket on the front panel of the welding machine and fully tighten clockwise.

Connect the machines gas hose to the regulator or flowmeter located on the shield gas cylinder.

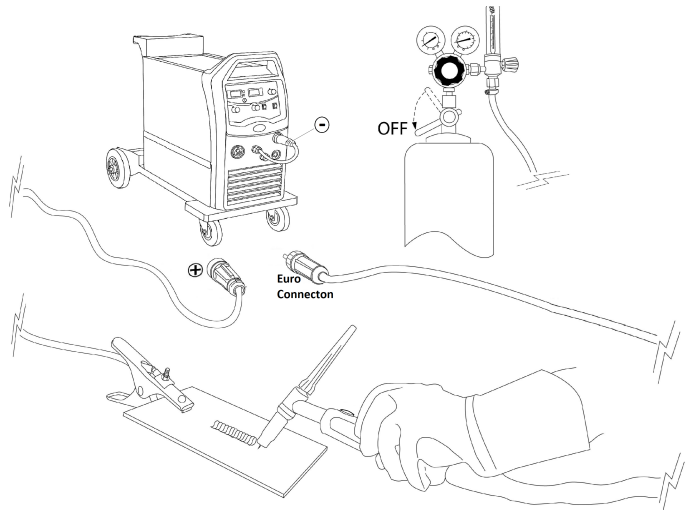

Before starting any welding activity ensure that you have suitable eye protection and protective clothing. Also take the necessary steps to protect any persons within the area.

Rotate the power switch on the back panel to “ON” and then select TIG by switching the welding mode switch to TIG. Set the amperage on the machine suitable for the application and tungsten being used (see table).

Ensure you have adequate welding current according to the thickness of the work and weld prep being carried out and filler wire being used.

Open the gas valve of the cylinder and then press the trigger switch on the TIG torch to obtain gas flow and then adjust the gas regulator to obtain the desired flow rate.

Post gas is automatically pre-set based on your pre-set welding current.

The MIG 250P allows the tungsten to be in direct contact with the work piece with minimal current so as not to leave tungsten deposits.

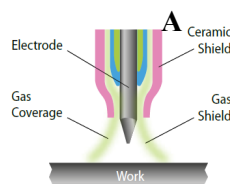

Tungsten Size	DC – Electrode Negative
1.0mm	15 – 80A
1.6mm	70 – 150A
2.4mm	150 – 250A
3.2mm	250A – 400A

Touch Electrode to work

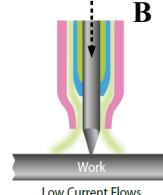

Lift Electrode

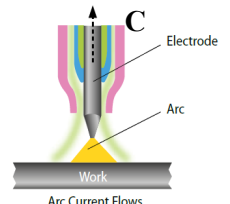

Offer the TIG torch tungsten to the material to be welded and once contact has been made (B), press the TIG torch switch and then the tungsten can be slowly lifted away to a max of 2-4mm from the work piece and the welding arc is then established (C).

Once welding is complete, release your finger from the TIG torch switch, the welding arc will now extinguish although please ensure you leave the TIG torch in place as to continue to shield the weld with gas coverage for a few seconds or until the post flow gas has stopped.

GUIDE TO TIG WELDING



Before starting any welding activity ensure that you have suitable eye protection and protective clothing. Also take the necessary steps to protect any persons within the welding area.

DC welding

Direct current welding is when the current flows in one direction only. Compared with AC welding the current once flowing will not go to zero until welding has ended.

The Jasic TIG series polarity should generally be set up for Direct Current - Electrode Negative (DCEN) as this method of welding can be used for a wide range of materials.

The TIG welding torch is connected to the negative output of the machine and the work return cable to the positive output.

When the arc is established the current flows in the circuit and the heat distribution in the arc is around 33% in the negative side of the arc (the welding torch) and 67% in the positive side of the arc (the work piece). This balance gives deep arc penetration of the arc into the work piece and reduces heat in the electrode.

This reduced heat in the electrode allows more current to be carried by smaller electrodes compared to other polarity connections. This method of connection is often referred to as straight polarity and is the most common connection used in DC welding.

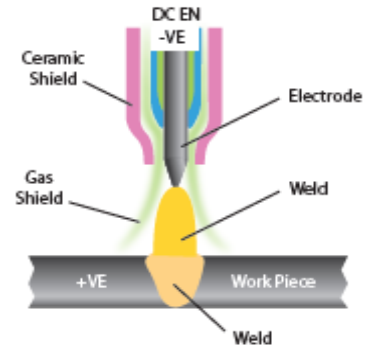

TIG welding techniques

- Before welding (especially with mild steel) you should ensure all material being welded are clean, as particulates can weaken the weld
- The torch angle is best kept at 15 - 20° (from vertical) away from the direction of travel. This assists with visibility of the weld area and allows easier access for the filler material
- The filler metal should be fed in at a low angle to help avoid touching the tungsten electrode and contaminating it
- The TIG welding arc melts the base material and the molten puddle melts the filler rod, it is important you resist the urge to melt the filler material directly into the welding arc
- For thinner sheet materials, a filler material may not be needed
- Prepare the tungsten correctly, using a diamond grinding wheel will give you the best results for a sharp point see page 48
- For welding stainless steel, be careful of applying too much heat. If the colour is dark grey and looks dirty and heavily oxidized then too much heat has been applied, this could also cause the material to warp. Reducing the amperage and increase travel speed may correct this problem, you could also consider using a smaller diameter filler material, as that will require less energy to melt

TIG welding amperage guide

Base Metal Thickness	Mild Steel DC Current	Stainless Steel DC Current	Tungsten Electrode Diameter	Filler Wire Diameter (If Required)	Argon Gas Flow Rate (Litres/Min)	Joint Types
1.0mm	40-50	25-35	1.0mm	1.6mm	5-7	Butt/Corner/Fillet/Lap
1.2mm	50-60	35-50	1.0mm	1.6mm	5-7	Butt/Corner/Fillet/Lap
1.6mm	70-90	50-70	1.6mm	1.6mm	6-8	Butt/Corner/Fillet/Lap
3.2mm	90-115	90-110	1.6mm	2.4mm	7-9	Butt/Corner/Fillet/Lap
4.8mm	140-165	125-150	2.4mm	3.2mm	10-12	Butt/Corner/Fillet/Lap
6.4mm	170-200	160-180	3.2mm	4.0mm	10-12	Butt/Corner/Fillet/Lap

GUIDE TO TIG WELDING



Before starting any welding activity ensure that you have suitable eye protection and protective clothing. Also take the necessary steps to protect any persons within the welding area.

TIG torch body and components

The torch body holds the various welding consumables in place as shown and is covered by a either a rigid phenolic or rubberised covering.

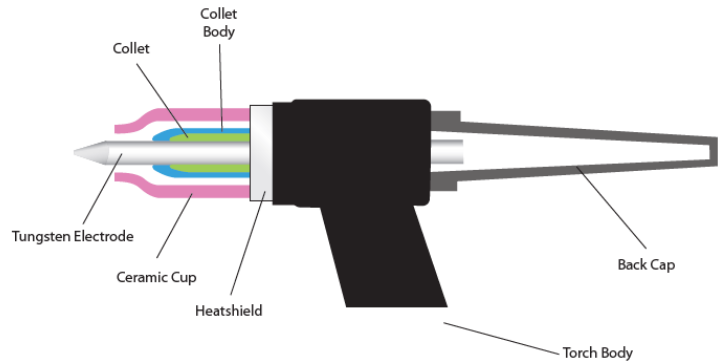

Collet body



The collet body screws into the torch body. It is replaceable and is changed to accommodate the different size tungsten's and their respective collets.

Collets



The welding electrode (tungsten) is held in the torch by the collet. The collet is usually made of copper or a copper alloy. The collet's grip on the electrode is secured when the torch back cap is tightened in place. Good electrical contact between the collet and tungsten electrode is essential for good welding current transfer.

Gas lens body

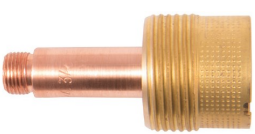

A gas lens is a device that can be used in place of the normal collet body. It screws into the torch body and is used to reduce turbulence in the flow of shield gas and produce a stiff column of undisturbed flow of shielding gas. A gas lens will allow the welder to move the nozzle further away from the joint allowing increased visibility of the arc.

A much larger diameter nozzle can be used which will produce a large blanket of shielding gas. This can be very useful in welding material like titanium. The gas lens will also enable the welder to reach joints with limited access such as inside corners.

Ceramic cups



Gas cups are made of various types of heat resistant materials in different shapes, diameters and lengths. The cups are either screwed onto the collet body or gas lens body or in some cases pushed in place. Cups can be made of ceramic, metal, metal-jacketed ceramic, glass or other materials. The ceramic type is quite easily broken so take care when putting the torch down.

Gas cups must be large enough to provide adequate shielding gas coverage to the weld pool and surrounding area. A cup of a given size will allow only a given amount of gas to flow before the gas flow becomes disturbed due to the speed of flow. Should this condition exist the size of cup should be increased to allow the flow speed to reduce and once again establish an effective regular shield.

Back cap

The back cap screws into the rear on the torch head and applies pressure to the back end of the collet which in turn forces up against the collet body, the resulting pressure holds the tungsten in place to ensure it does not move during the welding process.

Back caps are made from a rigid phenolic material and generally come in 3 sizes, short, medium and long.

GUIDE TO TIG WELDING



Before starting any welding activity ensure that you have suitable eye protection and protective clothing. Also take the necessary steps to protect any persons within the welding area.

TIG welding electrodes

TIG welding electrodes are a 'non consumable' as it is not melted into the weld pool and great care should be taken not to let the electrode contact the welding pool to avoid weld contamination. This would be referred to as tungsten inclusion and may result in weld failure.

Electrodes will often contain small quantities of metallic oxides which can offer the following benefits:

- Assist in arc starting
- Improve current carrying capacity of the electrode
- Reduce the risk of weld contamination
- Increase electrode life
- Increase arc stability

Oxides used are primarily zirconium, thorium, lanthanum or cerium. These are added usually 1% - 4%.



Tungsten Electrode Colour Chart - DC

Welding Mode	Tungsten Type	Colour
DC or AC/DC	Ceriated 2%	Grey
DC or AC/DC	Lanthanated 1%	Black
DC or AC/DC	Lanthanated 1.5%	Gold
DC or AC/DC	Lanthanated 2%	Blue
DC	Thoriated 1%	Yellow
DC	Thoriated 2%	Red

Tungsten Electrode Current Ranges

Tungsten Electrode Size	DC Current Amp
1.0mm	30 - 60
1.6mm	60 - 115
2.4mm	100 - 165
3.2mm	135 - 200
4.0mm	190 - 280
4.8mm	250 - 340

Tungsten electrode preparation - DC

When welding at low current the electrode can be ground to a point. At higher current a small flat on the end of the electrode is preferable as this helps with arc stability.

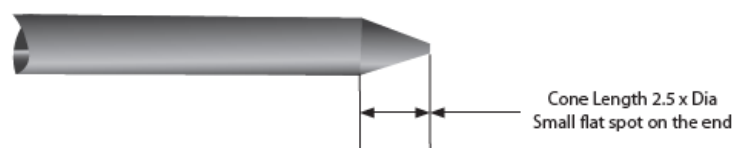

On inverter controlled AC & DC machines use tungsten electrode with cone length around 2.5 times the tungsten diameter

Electrode grinding

It is important when grinding the electrode to take all necessary precautions such as wearing eye protection and ensuring adequate protection against breathing in any grinding dust.

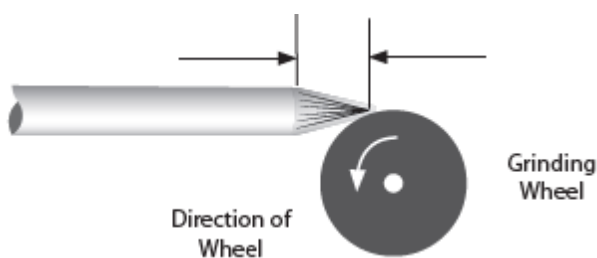

Tungsten electrodes should always be ground lengthwise (as shown) and not in a radial operation. Electrodes ground in a radial operation tend to contribute to arc wander due to the arc transfer from the grinding pattern. Always use a grinder solely for grinding electrodes to avoid contamination.

GUIDE TO TIG WELDING



Before starting any welding activity ensure that you have suitable eye protection and protective clothing. Also take the necessary steps to protect any persons within the welding area.

TIG welding consumables

The consumables of the TIG welding process are filler wires and shield gas.

Filler wires

Filler wires come in many different material types and usually as cut lengths, unless some automated feeding is required where it will be in reel form. Filler wire is generally fed in by hand. Always consult the manufacturer's data and welding requirements.

Filler Wire Diameter	DC Current Range (Amps)
1.0mm	20-90
2.4mm	65-115
3.2mm	100-165
4.8mm	200-350

Filler Wire Selection Guide

Gases

Shielding gas is required when welding to keep the weld pool free of oxygen. Whether you are welding mild steel or stainless steel the most commonly used shielding gas used in TIG welding is argon. For more specialised applications an argon helium mix or pure helium can be used.

TIG welding arc starting - Lift TIG (lift arc)

Not to be confused with scratch start, this arc starting method allows the tungsten to be in direct contact with the work piece first but with minimal current so as not to leave a tungsten deposit when the tungsten is lifted and an arc is established.

With lift TIG start the open circuit voltage (OCV) of the welder folds back to a very low voltage output when the unit senses it has made continuity with the work piece. Once the torch is lifted the unit increases output as the tungsten leaves the surface. This creates little contamination and preserves the point on the tungsten although this is still not a 100% clean process. The tungsten can still get contaminated but lift TIG is still a much better option than scratch starting for mild and stainless steel although these methods of arc starting are not a good option when welding aluminium.

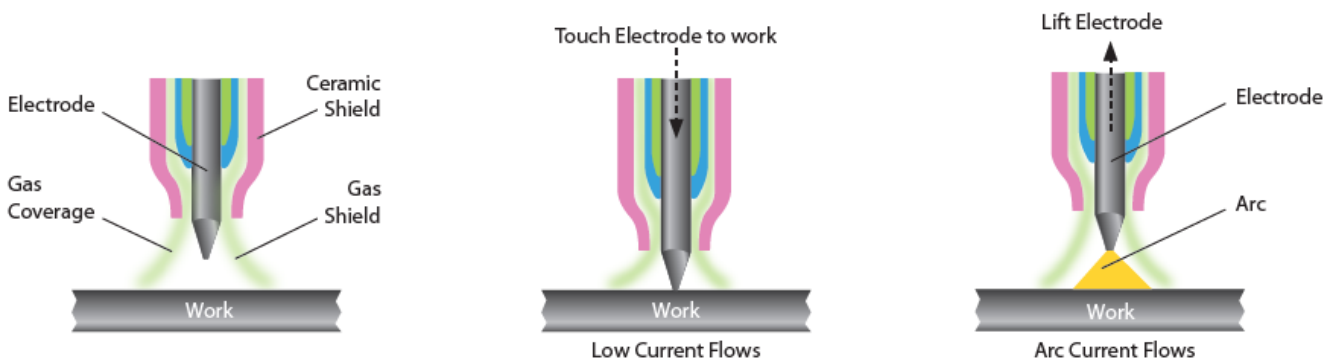

TIG WELDING PROBLEMS



Before starting any welding activity ensure that you have suitable eye protection and protective clothing. Also take the necessary steps to protect any persons within the welding area.

TIG welding defects and prevention methods

<u>Defect</u>	<u>Possible cause</u>	<u>Action</u>
Excessive tungsten use	Set up for DCEP	Change to DCEN
	Insufficient shield gas flow	Check for gas restriction and correct flow rates. Check for drafts in the weld area
	Electrode size too small	Select correct size
	Electrode contamination during cooling time	Extend post flow gas time
Porosity/weld contamination	Loose torch or hose fitting	Check and tighten all fittings
	Inadequate shield gas flow	Adjust flow rate - normally 8-12L/m
	Incorrect shield gas	Use correct shield gas
	Gas hose damaged	Check and repair any damaged hoses
	Base material contaminated	Clean material properly
	Incorrect filler material	Check correct filler wire for grade of use
No operation when torch switch is operated	Torch switch or cable faulty	Check the torch switch continuity and repair or replace as required
	ON/OFF switch turned off	Check position of ON/OFF switch
	Mains fuses blown	Check fuses and replace as required
	Fault inside the machine	Call for a repair technician
Low output current	Loose or defective work clamp	Tighten/replace clamp
	Loose cable plug	Check and tighten all plugs
	Power source faulty	Call a repair technician
Will not strike an arc	Weld/power cable open circuit	Check all cables and connections for continuity, especially the torch cables
	No shield gas flowing	Check cylinder contents, regulator and valves, also check the power source
Unstable arc when welding in DC	Tungsten contaminated	Break off contaminated end and regrind the tungsten
	Arc length incorrect	Arc length should be between 3-6mm
	Material contaminated	Clean all base and filler material
	Electrode connected to the wrong polarity	Reconnect to correct polarity
Arc is difficult to start	Incorrect tungsten type	Check and fit correct tungsten
	Incorrect shield gas	Use argon shield gas

TIG WELDING PROBLEMS



Before starting any welding activity ensure that you have suitable eye protection and protective clothing. Also take the necessary steps to protect any persons within the welding area.

TIG welding defects and prevention methods

<u>Defect</u>	<u>Possible cause</u>	<u>Action</u>
Excessive bead build up, poor penetration or poor fusion at the edges of the weld	Weld current too low	Increase the welding amperage Poor material preparation
Weld bead flat and too wide or undercut at the weld edge or burning through	Weld current too high	Decrease the welding amperage
Weld bead too small or insufficient penetration	Welding travel speed too fast	Reduce your welding travel speed
Weld bead too wide or excessive bead build up	Welding travel speed too slow	Increase your welding travel speed
Uneven leg length in fillet joint	Wrong placement of filler rod	Re-position filler rod
Tungsten melts or oxidises when welding arc is made	TIG torch lead connected to + Little or no gas flow to weld pool Gas cylinder or hoses contain impurities The tungsten is too small for the weld current TIG/MMA selector set to MMA	Connect to - polarity Check gas apparatus as well as torch and hoses for breaks or restrictions Change gas cylinder and blow out torch and gas hoses Increase the size of the tungsten Ensure you have the power source set to TIG function

MAINTENANCE



The following operation requires sufficient professional knowledge on electric aspects and comprehensive safety knowledge. Make sure the input cable of the machine is disconnected from the electricity supply and wait for 5 minutes before removing the machine covers.

In order to guarantee that the arc welding machine works efficiently and in safety, it must be maintained regularly. Operators should understand the maintenance methods and means of arc welding machine operation. This guide should enable customers to carry out simple examination and safeguarding by themselves, and to reduce the fault rate and repair times of the arc welding machine, so as to lengthen service life of the MIG welding machine.

Period

Maintenance item

Daily examination	<ul style="list-style-type: none"> • Check the condition of the machine, mains cables, welding cables and connections. • Check for any warnings LEDs and machine operation.
Monthly examination	<ul style="list-style-type: none"> • Disconnect from the mains supply and wait for at least 5 minutes before removing the cover. • Check internal connections and tighten if required. • Clean the inside of the machine with a soft brush and vacuum cleaner. • Take care not to remove any cables or cause damage to components. • Ensure that ventilation grills are clear. • Carefully replace the covers and test the unit. <p>This work should be carried out by a suitably qualified competent person.</p>
Yearly examination	<ul style="list-style-type: none"> • Carry out an annual service to include safety check in accordance with the manufacturers standard (EN 60974-1). <p>This work should be carried out by a suitably qualified competent person.</p>

⇒ **Ensure the power is disconnected before working on the machine.**

⇒ **Always wait 5 minutes after power switch off before opening the case.**

SERVICE SCHEDULE RECORD

Date	Type of service and work carried out	Serviced by	Due date for next check

TROUBLESHOOTING



The following operation requires sufficient professional knowledge on electric aspects and comprehensive safety knowledge. Make sure the input cable of the machine is disconnected from the electricity supply and wait for 5 minutes before removing the machine covers.

Before arc welding machines are dispatched from the factory, they have already been checked thoroughly. The machine should not be tampered with or altered. Maintenance must be carried out carefully. If any wire becomes loose or is misplaced, it maybe potentially dangerous to the user!

Only professional maintenance personnel should repair the machine!

Ensure the power is disconnected before working on the machine. Always wait 5 minutes after power switch off before removing the panels.

Description of fault	Possible cause
The power LED is OFF and the fan is not functioning	The primary supply voltage has not been switched ON or input fuse has blown
	The welding power source input switch is switched OFF
	Loose connections internally
The fault LED is ON and the fan is running	The machine is under over-heating protection status, it will recover automatically after the welding machine is cooled Check incoming mains supply to ensure it is within 230V +/- 15%
Wire feed motor does not rotate when the MIG torch trigger switch is depressed	Wire feed speed may be set to zero
	Check supply to wire feed motor
	Motor PCB may be faulty
Welding current reduces when welding	Poor work lead connection to the work piece
TIG electrode melts when arc is struck	TIG torch is connected to the (+) VE terminal
No gas flow when the MIG torch trigger switch is depressed	Empty gas cylinder
	Gas regulator is turned off
	Gas hose is blocked or cut
	Torch trigger switch lead is disconnected or switch or the trigger lead is faulty
Difficult to ignite the arc	The welding voltage is too low or the wire feed speed is set too high
The electrode holder becomes very hot	The rated current of the electrode holder is smaller than its actual working current, replace it with a higher rated current capacity
Excessive spatter in MMA welding	The output polarity connection is incorrect, exchange the polarity
Other malfunction	Contact your supplier
Overheat LED lights up	Let the machine cool, it will automatically start again
	Insufficient cooling air
	Cooling fan is not running
Wire continues to feed through when the MIG torch switch is released	The trigger mode switch is set to 4T rather than 2T
	Faulty MIG torch switch
Machine factory reset	Pressing and holding the synergic button for 7 seconds will reset the front control panel

WEEE disposal

The equipment is manufactured with materials which do not contain any toxic or poisonous materials dangerous to the operator.

When the equipment is scrapped, it should be dismantled separating components according to the type of materials.

Do not dispose of the equipment with normal waste. The European Directive 2002/96/EC and United Kingdom's Directive The Waste Electrical and Electronic Equipment (WEEE) regulations 2013 states that electrical equipment that has reached its end of life must be collected separately and returned to an environmentally compatible recycling facility.

Jasic has a relevant recycling system which is compliant and registered in the UK with the environment agency. Our registration reference is WEEMM3813AA.

In order to comply with WEEE regulations outside the UK you should contact your supplier.

RoHS Compliance Declaration

We herewith confirm, that the above mentioned product does not contain any of the restricted substances as listed in EU Directive 2011/65/EU and the UK directive ROHS Regulations 2012 in concentrations above the limits as specified therein.

UKCA Declaration of Conformity

The manufacturer, or its legal representative Wilkinson Star Limited, declares that the equipment described below is designed and produced according to following UK legislation:

- Electrical equipment safety 2016
- Electromagnetic compatibility (EMC) regulations 2016
- The restrictions of the use of certain hazardous substances in electrical and electronic equipment regulations 2012

And inspected according to following designated standards:

- EN 60 974-1:2018+A1:2019
- EN 60 974-10:2014+A1:2015

Any alteration or change to these machines by any unauthorized person makes this declaration invalid.

Model:

JM-250P

Authorised Representative:

Wilkinson Star Limited
Shield Drive
Wardley Industrial Estate
Worsley
Manchester
M28 2WD

Disclaimer:

Please note that this confirmation is given to the best of our present knowledge and belief. Nothing herein represents and/or may be interpreted as warranty within the meaning of the applicable warranty law.

EC Declaration of Conformity

EC DECLARATION OF CONFORMITY

The manufacturer, or its legal representative **Wilkinson Star Limited**, declares that the equipment described below is designed and produced according to following EU Directives:

- Low Voltage Directive (LVD), No.: 2014/35/EU
- Electromagnetic compatibility (EMC) Directive, No.: 2014/30/EU

And inspected according to following

EU - Norms:

- EN 60 974-1:2012
- EN 60 974-10:2014+A1

Any alteration or change to these machines by any unauthorized person makes this Declaration invalid.

Wilkinson Star model
JM-250P

Jasic Model
MIG 250P (N249)

Authorised Representative

Wilkinson Star Limited
Shield Drive, Wardley Industrial Estate,
Worsley, Manchester M28 2WD
Tel 0161 793 8127

Signature

Dr John A Wilkinson OBE

Position Chairman

Manufacturer

Shenzhen Jasic Technology Co LTD
No3 Qinglan, 1st Road
Pingshan District
Shenzhen, China

Signature

Shenzhen Jasic Technology Co LTD

Position

Date



Company stamp

Date



Company stamp

STATEMENT OF WARRANTY

All new JASIC welders, plasma cutters and multi-process units sold through our partner Wilkinson Star Limited within the United Kingdom and Ireland shall be warranted to the original owner, non transferable, against failure due to defective materials or production. The warranty period is 5 years following the date of purchase. We recommend you register your product within 28 days of purchase. The original invoice is documentation for the standard warranty period. The warranty period is based on a single shift pattern.

Defective units shall be repaired or replaced by the company at our workshop. The company may opt to refund the purchase price (less any costs and depreciation due to use and wear). The company reserves the right to alter the warranty conditions at any time with effect for the future.

A prerequisite for the full warranty is that products are operated in accordance with the operating instructions supplied, observing the relevant installation and any legal requirements recommendations and guidelines and carrying out the maintenance instructions shown in the operator manual. This should be carried out by a suitably qualified competent person.

In the unlikely event of a problem, this should be reported to Jasic technical support team to review the claim.

The customer has no claim to loan or replacement products whilst repairs are being performed.

The following falls outside the scope of the warranty:

- Defects due to natural wear and tear
- Failure to observe the operating and maintenance instructions
- Connection to an incorrect or faulty mains supply
- Overloading during use
- Any modifications that are made to the product without the prior written consent
- Software errors due incorrect operation
- Any repairs that are carried out using non-approved spare parts
- Any transport or storage damage
- Direct or indirect damage as well as any loss of earnings are not covered under the warranty
- External damage such as fire or damage due to natural causes e.g. flooding

NOTE: Under the terms of the warranty, welding torches, their consumable parts, wire feed unit drive rolls and guide tubes, work return cables and clamps, electrode holders, connection and extension cables, mains and control leads, plugs, wheels, coolant etc. are covered with a 3 month warranty.

Jasic shall in no event be responsible for any third party expenses or expenses/costs or any indirect or consequential expenses/costs.

Jasic will submit an invoice for any repair work performed outside the scope of the warranty. A quotation for any non warranty will be raised prior to any repairs being carried out.

The decision about repair or replacement of the defective part(s) is made by Jasic. The replaced part(s) remain(s) Jasic property.

Warranty extends only to the machine, its accessories and parts contained inside. No other warranty is expressed or implied. No warranty is expressed or implied in regards to the fitness of the product for any particular application or use.

For further information on Jasic product warranty terms and product warranty registration please visit:

www.jasic-warranty.co.uk/terms

www.jasic-warranty.co.uk

SCHEMATIC

Wiring diagram for the JM-250P

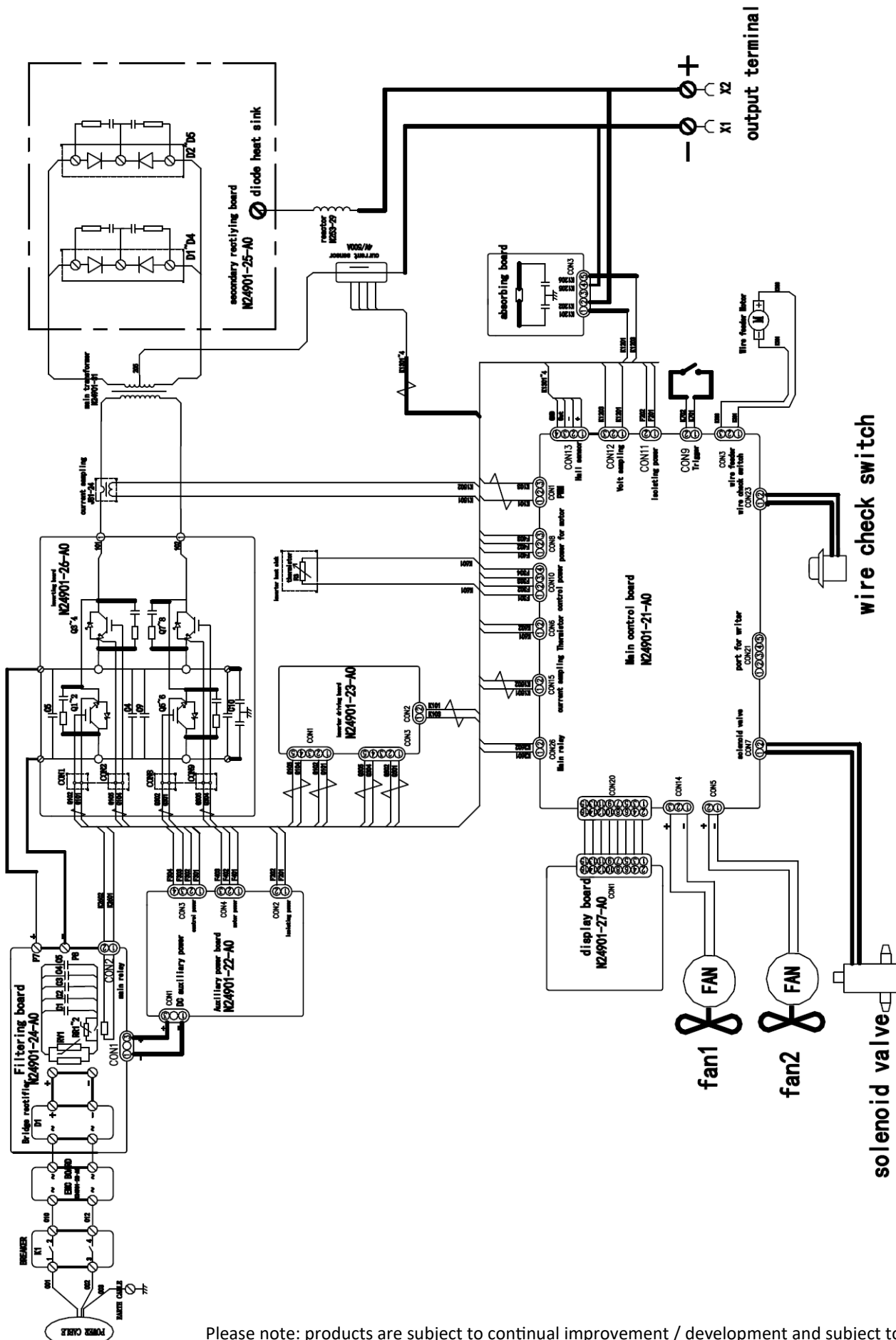

Please note: products are subject to continual improvement / development and subject to change

OPTIONS AND ACCESSORIES

Part Number	Description
T250-3	Titanium 250 MIG Torch 3m Euro
T250-4	Titanium 250 MIG Torch 4m Euro
T250-5	Titanium 250 MIG Torch 5m Euro
WCS25-3WEL	Welding Cable Set (MMA) 3m
WC-2-03LD	Electrode Holder and Lead 3m
EC-2-03LD	Work Return Lead and Clamp 3m
CP3550	Cable Plug 35-50mm
WP26-12JE	WP26 Euro Style TIG Torch 4m
WP26-25JE	WP26 Euro Style TIG Torch 8m
JH-HDX	Jasic HD True Colour Auto Darkening Welding Helmet
SSARG2G	Single Stage 2 Gauge Argon Regulator
TSP-250-P	MIG250P Spool Gun

DRIVE ROLL OPTIONS

Model JM-250P	Feed Roll Part Number	Description	Feed Roll Diameter/Width	Quantity Required
JM-250P	10054934 *	"V" Groove 0.8mm/1.0mm	30mm X 10mm	2
	10054932 *	"V" Groove 1.0mm/1.2mm	30mm X 10mm	2
	10078138 *	"U" Groove 0.8mm/1.0mm	30mm X 10mm	2
	10054930 *	"U" Groove 1.0mm/1.2mm	30mm X 10mm	2
	10054937 *	Flat Pressure Roll	30mm X 10mm	2
	10054936 *	V Pressure Roll 1.00mm/1.2mm	30mm X 10mm	2
	1004V0608	"V" Groove 0.6mm/0.8mm	30mm X 10mm	2
	10054935	"V" Groove 1.2mm/1.6mm	30mm X 10mm	2
	10054931	"U" Groove 1.2mm/1.6mm	30mm X 10mm	2
	10062293	Knurled 1.0mm/1.2mm	30mm X 10mm	2
	10062292	Knurled 1.2mm/1.6mm	30mm X 10mm	2
	10054933	V Pressure Roll 1.2mm/1.6mm	30mm X 10mm	2

* Drive roll supplied as standard with the machine package

Wilkinson Star Limited

Shield Drive
Wardley Industrial Estate
Worsley
Manchester
UK
M28 2WD

+44 (0)161 793 8127



www.jasic.co.uk

November 2022 Issue 10