

MasterTig 235ACDC, 325DC, 335ACDC, 425DC

MasterTig Cooler M

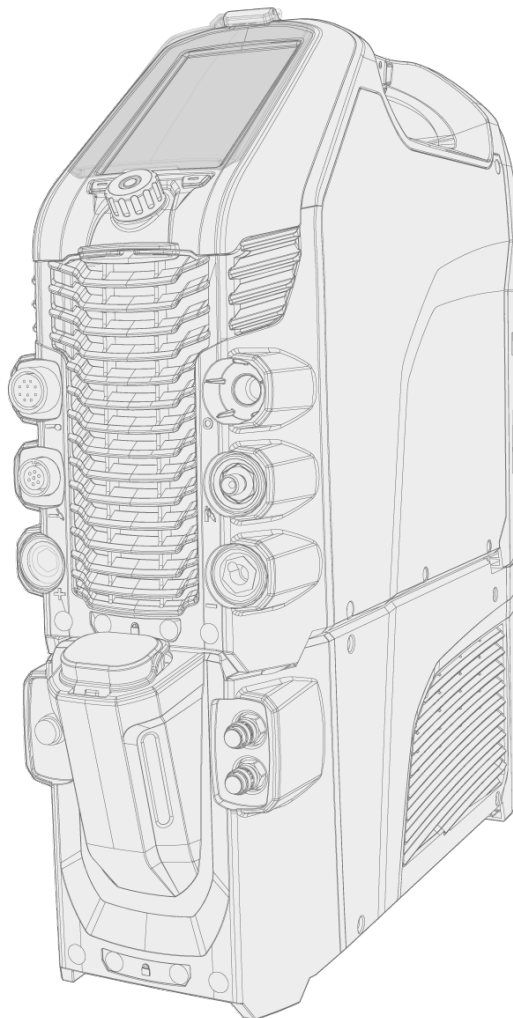

CONTENTS

1. General	4
1.1 Equipment description	5
2. Installation	7
2.1 Installing mains plug	8
2.2 Installing control panel	9
2.3 Installing cooling unit	11
2.4 Installing particle filter (optional)	13
2.5 Mounting units on cart (optional)	14
2.6 Connecting TIG torch	16
2.7 Connecting earth return cable and clamp	17
2.8 Connecting MMA electrode holder	18
2.9 Installing remote control	19
2.10 Installing gas bottle	22
2.11 Installing gas bottle on cart	23
2.12 Moving equipment by lifting	24
3. Operation	26
3.1 Operating power source	27
3.2 Operating control panels MTP23X and MTP33X	28
3.2.1 Home	30
3.2.2 Start & stop sequence	30
3.2.3 Settings	34
3.3 Operating control panel MTP35X	40
3.3.1 Home view	41
3.3.2 Weld Assist view	42
3.3.3 Memory channels view	47
3.3.4 Start & stop sequence view	47
3.3.5 Pulse view	52
3.3.6 Current mode view	54
3.3.7 Settings view	56
3.3.8 Info view	60
3.3.9 Screen saver	61
3.4 Operating cooling unit	63
3.5 Remote control	64
4. Maintenance	65
4.1 Disposal	67
5. Troubleshooting	68
5.1 Error codes	70

6. Technical data	72
6.1 Power source MasterTig 235ACDC	73
6.2 Power source MasterTig 325DC	75
6.3 Power source MasterTig 335ACDC	77
6.4 Power source MasterTig 425DC	79
6.5 Cooling unit MasterTig Cooler M	81
6.6 TIG guide tables	82
6.7 Welding processes and features	83
6.8 Symbols used	89
7. Ordering codes	92
7.1 Accessories	93

1. GENERAL

These instructions describe the use of Kemppi's MasterTig 235ACDC, 325DC, 335ACDC and 425DC welding power sources designed for demanding industrial use. The full system consists of MasterTig power source with either DC (MTP23X) or AC/DC (MTP33X, MTP35X) control panel, optional MasterTig Cooler M water cooler, optional transport unit and Flexlite TX TIG welding torch.



For the symbols used in this documentation, refer to "Symbols used" on page 89.

Important notes

Read the instructions through carefully. For your own safety, and that of your working environment, pay particular attention to the safety instructions delivered with the equipment.

Items in the manual that require particular attention in order to minimize damage and harm are indicated with the below symbols. Read these sections carefully and follow their instructions.

 *Note: Gives the user a useful piece of information.*

 *Caution: Describes a situation that may result in damage to the equipment or system.*

 *Warning: Describes a potentially dangerous situation. If not avoided, it will result in personal damage or fatal injury.*

DISCLAIMER

While every effort has been made to ensure that the information contained in this guide is accurate and complete, no liability can be accepted for any errors or omissions. Kemppi reserves the right to change the specification of the product described at any time without prior notice. Do not copy, record, reproduce or transmit the contents of this guide without prior permission from Kemppi.

1.1 Equipment description

Kemppi MasterTig 235 AC/DC, 325 DC, 335 AC/DC and 425 DC welding equipment is designed for professional industrial use, with characteristics especially suitable for welding materials like aluminum and stainless steel. The equipment consists of power source, control panel and cooling unit (optional). The MasterTig Cooler M cooling unit is used in liquid-cooled TIG welding with MasterTig power source. The multipurpose MasterTig power sources are suitable for MMA welding, TIG welding and pulsed TIG welding with both direct current (DC) and, depending on the model selected, alternating current (AC).

Available power source models:

- MasterTig 235ACDC GM, multi-voltage and generator compatible (230 A AC/DC) *
- MasterTig 325DC (300 A DC)
- MasterTig 325DC G, generator compatible (300 A DC) *
- MasterTig 325DC GM, multi-voltage and generator compatible (300 A DC)
- MasterTig 335ACDC (300 A AC/DC)
- MasterTig 335ACDC G, generator compatible (300 A AC/DC) *
- MasterTig 335ACDC GM, multi-voltage and generator compatible (300 A AC/DC)
- MasterTig 425DC G, generator compatible (400 A DC) *

* A dedicated VRD (Voltage Reduction Device) model version, where the VRD function is locked on, is also available.

Control panels:

- MTP23X control panel (DC, membrane panel)
- MTP33X control panel (AC/DC, membrane panel)
- MTP35X control panel (AC/DC, 7" TFT LCD display panel).

Equipment:

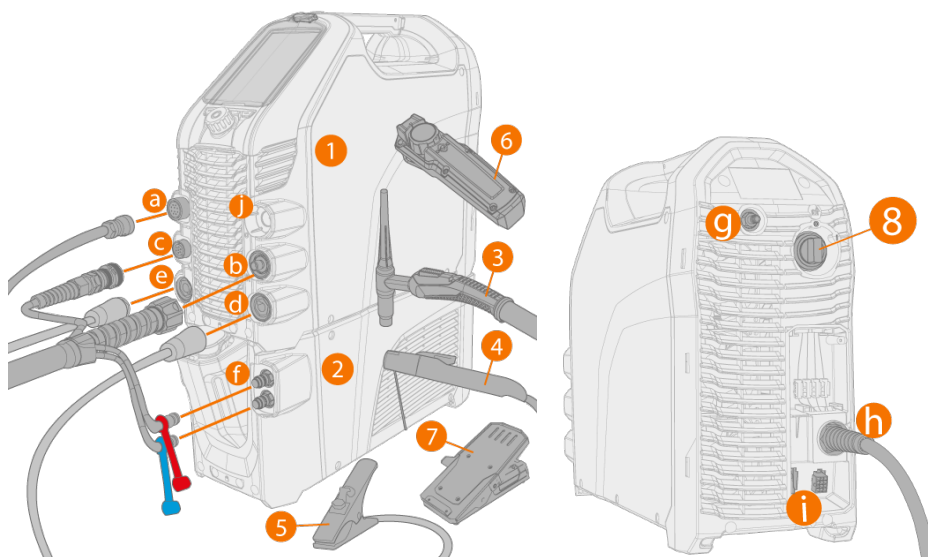

1. MasterTig 235/325/335/425 power source
2. MasterTig Cooler M (optional)
3. TIG torch
4. Electrode holder
5. Earth return cable and clamp
6. Remote control (wired or wireless)
7. Foot pedal remote control (wired or wireless)

8. Power ON/OFF switch.

Connections:

- a. External remote control connector
- b. TIG welding cable connector (connection type R1/4)
- c. Control cable connector
- d. DIX connector (-)
- e. DIX connector (+)
- f. Coolant liquid inlet and outlet (color-coded)
- g. Gas hose connection
- h. Mains cable
- i. Cooling unit connection
- j. Empty holder for unused DIX connector.

EQUIPMENT IDENTIFICATION



Serial number

Serial number of the device is marked on the rating plate or in another distinctive location on the device. It is important to make correct reference to the serial number of the product when ordering spare parts or making repairs for example.

Quick Response (QR) code

The serial number and other device-related identification information may also be saved in the form of a QR code (or a barcode) on the device. Such code can be read by a smartphone camera or with a dedicated code reader device providing fast access to the device-specific information.

2. INSTALLATION

-  Do not connect the equipment to the mains before the installation is complete.
-  Do not attempt to move or hang the equipment mechanically (e.g. with a hoist) from the handle on the power source unit. The handle is meant only for manual lifting.
-  Place the machine on a horizontal, stable and clean ground. Protect the machine from rain and direct sunshine. Check that there is enough space for cooling air circulation in the machine vicinity.

Before installation

- Make sure to acknowledge and follow the local and national requirements regarding installation and use of high voltage units.
- Check the contents of the packages and make sure the parts are not damaged.
- Before you install the power source on site, see the requirements for the mains cable type and fuse rating given in the "Technical data" on page 72 chapter.

 Do not connect the machine to the mains before the installation is complete.

 Only an authorized electrician is allowed to install the mains cable.

Distribution network

 **MasterTig 235ACDC:** This equipment complies with IEC 61000-3-12 and can be connected to public low-voltage systems.

 **MasterTig 325DC and 335ACDC:** Provided that the public low voltage short circuit power at the point of common coupling is higher than or equal to the value stated on the list below, this equipment is compliant with IEC 61000-3-11 and IEC 61000-3-12 and can be connected to public low voltage systems. It is the responsibility of the installer or user of the equipment to ensure, by consultation with the distribution network operator if necessary, that the system impedance complies with the impedance restrictions.

- MasterTig 325DC and 335ACDC: 1.7 MVA
- MasterTig 325DC G and 335ACDC G: 1.9 MVA
- MasterTig 325DC GM and 335ACDC GM: 1.4 MVA
- MasterTig 425DC G: 2.0 MVA

 According to the EMC classification (Class A), the MasterTig 235, 325, 335 and 425 equipments are not intended to be used in residential locations where the electrical power is provided by the public low-voltage supply system.

2.1 Installing mains plug

 Only an authorized electrician is allowed to install the mains cable and plug.

 Do not connect the machine to the mains before the installation is complete.

Install the 3-phase plug according to the MasterTig power source and site requirements. In the 1-phase power source (MasterTig 235ACDC) the plug is pre-installed. Refer also to "Technical data" on page 72 for power source specific technical information.

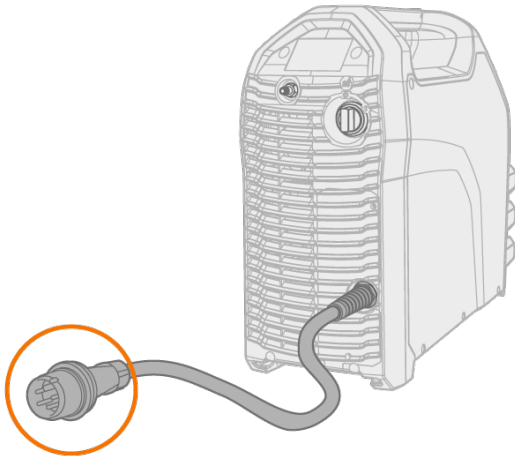

2.2 Installing control panel

Tools:

- Screwdriver, Torx head (T20).

1. Connect the control panel's cable and mount the control panel in place:

- >> Insert the top of the panel in the slot first, and then lower the bottom of the panel down.
- >> Push the bottom of the panel firmly so that it locks in place.

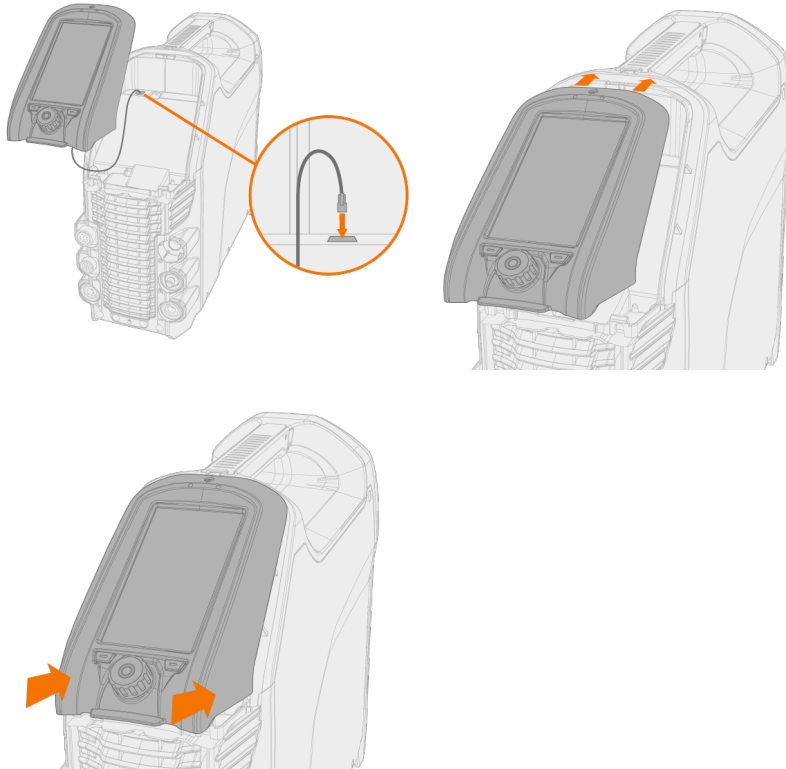



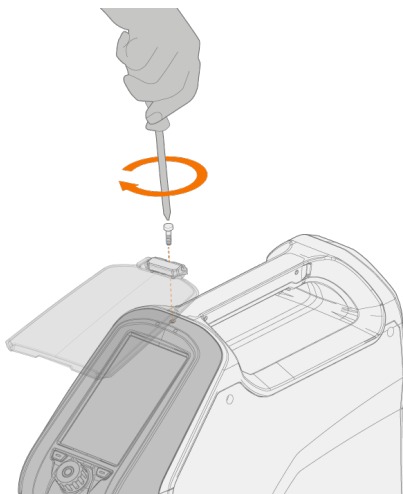

2. Secure the control panel together with the hinged panel cover in place with the screw provided.





The hinged panel cover and the control panel are secured with the same screw.

2.3 Installing cooling unit

-  *Only an authorized electrician is allowed to install the cooling unit.*
-  *Do not connect the equipment to the mains before the installation is complete.*
-  *Do not attempt to move the power source with a hoist from its handle. The handle is meant for manual lifting only.*
-  *When a transport cart is used, refer also to "Mounting units on cart (optional)" on page 14.*

Tools:

- Screwdriver, Torx head (T20).

1. Remove the power source's rear cover.

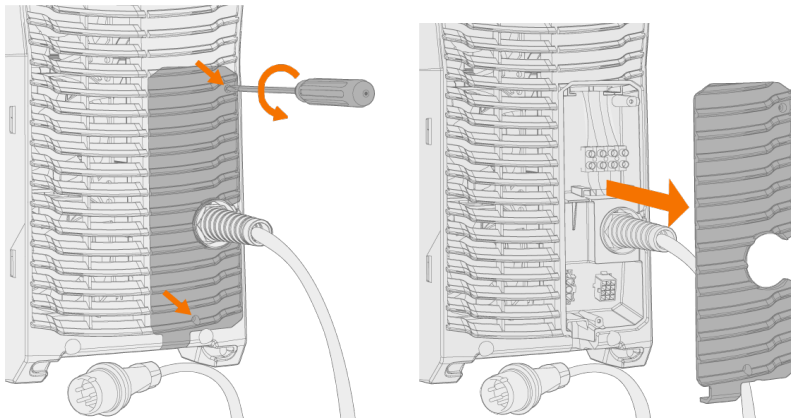

2. Move the power source on top of the cooling unit so that the bar in the rear goes into the rear connection interface and lower the front onto the front connection interface. Secure the power source from the front with the screws provided.

-  *Ensure that the cooling unit's connection cables don't get caught between the units and get damaged in the process.*

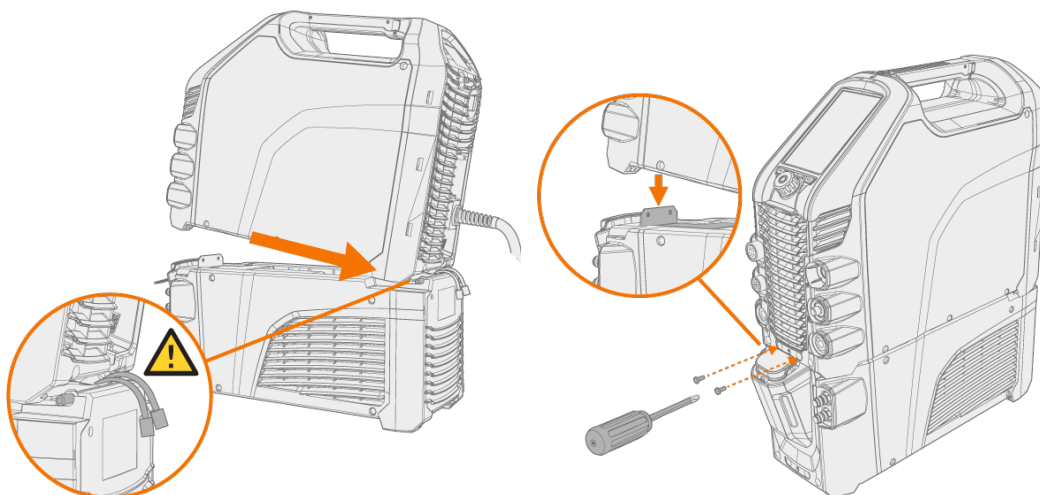

3. Connect the cooling unit cables and put the rear cover back.

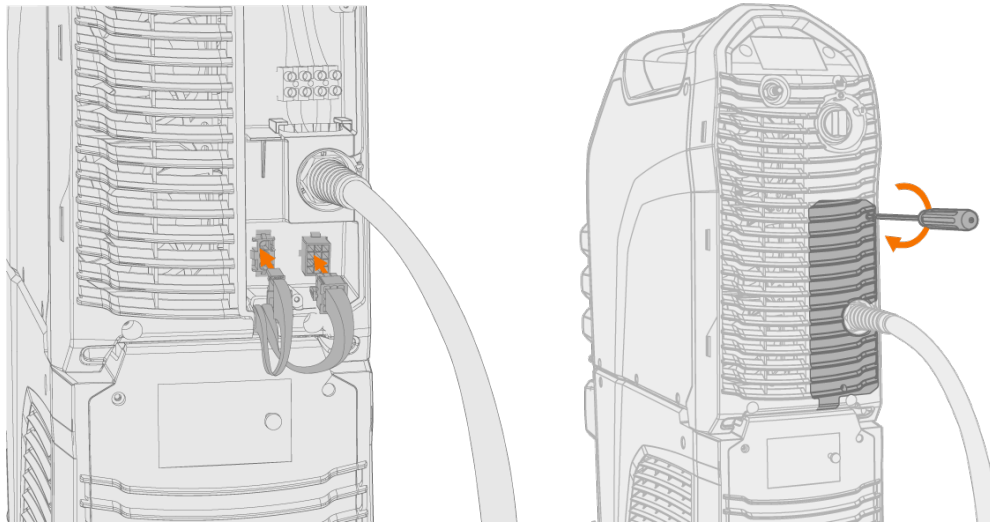

4. Fill the cooling unit with cooling liquid.

>> MasterTig Cooler M tank volume is 3 litres and the recommended coolant is MPG 4456 (Kemppi mixture).

! Avoid cooling liquid contact with skin or eyes. In case of an injury, seek for medical advice.

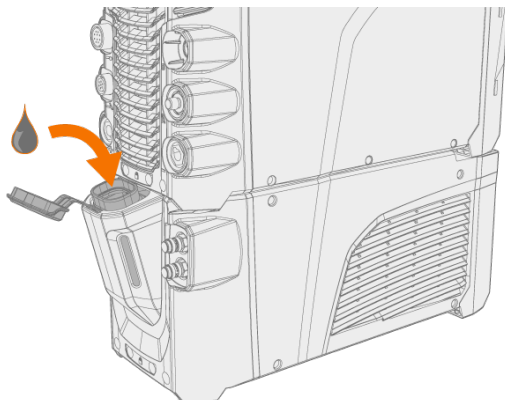

2.4 Installing particle filter (optional)

The optional particle filter is installed together with an additional filter frame as a pack.

1. Place the filter into the filter frame

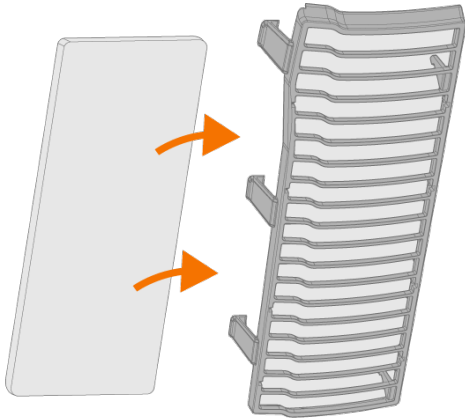

2. Install the filter pack in front of the air inlet on the rear of the power source.

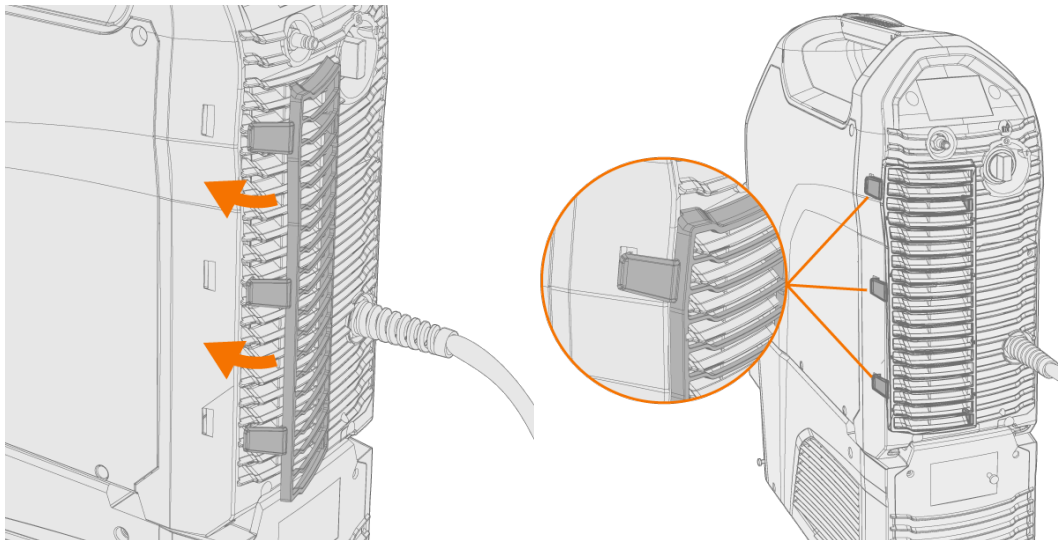

2.5 Mounting units on cart (optional)

There are three different transport unit options available for use with MasterTig welding equipment: undercarriage P43MT, 4 wheel cart P45MT and 2 wheel cart T25MT.

Tools:

- Allen key set.
1. Assemble the transport unit according to the instructions delivered with it. With the T25MT cart, the welding equipment securing bracket (*) is attached once the welding equipment is installed on the cart.

Transport units from left to right: P45MT, T25MT, P43MT.

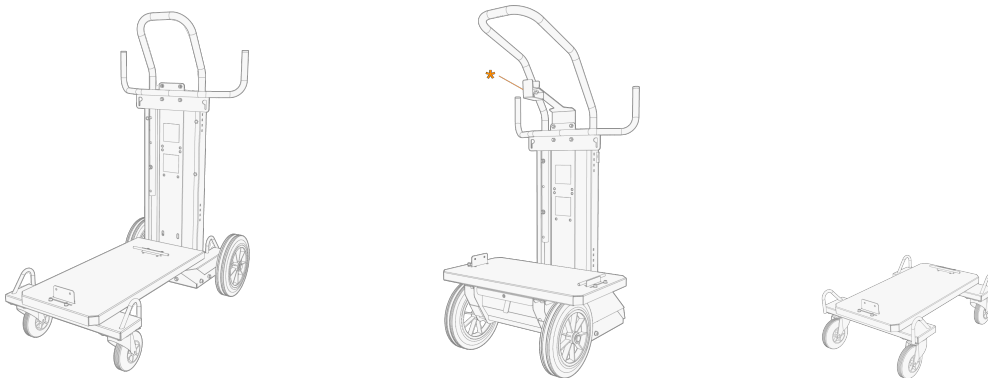

2. Move the unit on top of the cart so that the bar in the rear goes into the rear connection interface and lower the front onto the front connection interface. Secure the power source from the front with the screws (2 x M5x12) provided.

 Do not attempt to move the power source with a hoist from its handle. The handle is meant for manual lifting only.

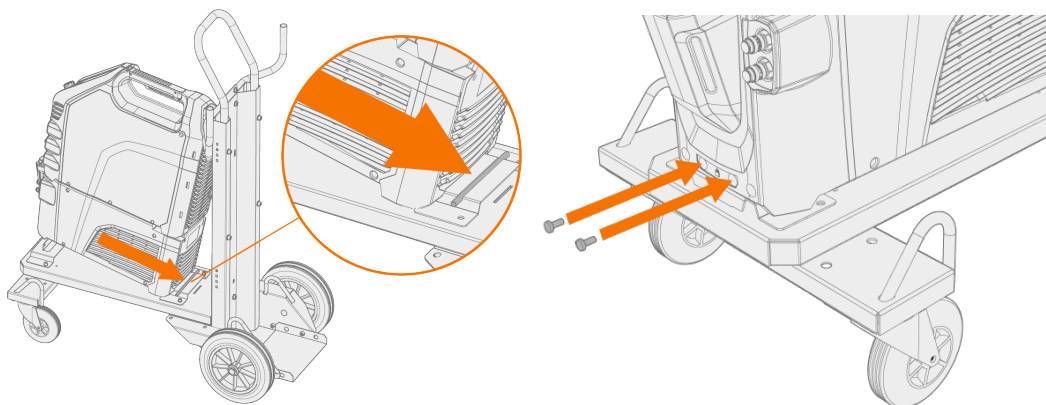

- i** With the 2 wheel cart (T25MT), an additional securing bracket is attached to the power source handle. Secure the bracket to the cart with the screws provided (M8x16).

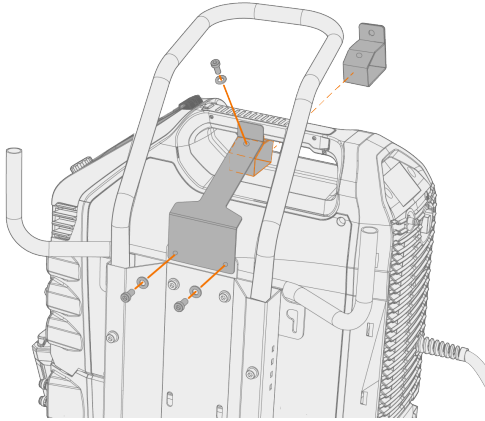

2.6 Connecting TIG torch

Gas-cooled TIG torch:

1. Assemble the TIG torch according to the instructions delivered with the torch.
2. Connect the TIG torch cables to the power source. Secure by turning the connectors clockwise.

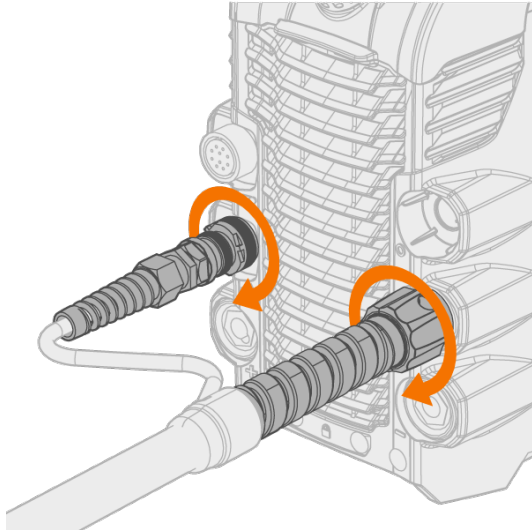

Water-cooled TIG torch:

 The cooling unit must already be installed and in place at this stage. Refer to "Installing cooling unit" on page 11.

1. Assemble the TIG torch according to the instructions delivered with the torch.
2. Connect TIG torch cables and the water cooling inlet and outlet hoses to the units. Secure by turning the connectors clockwise.

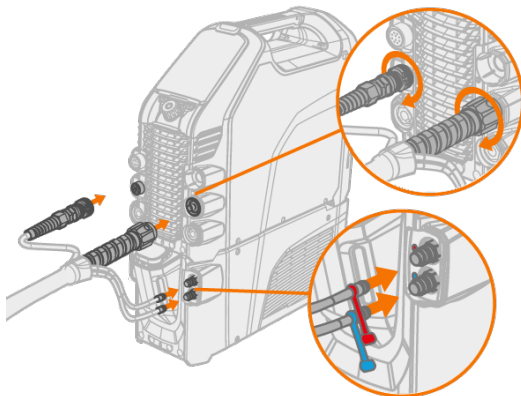

 The water cooling connectors are color-coded.

Tip: For Kemppi welding torches, refer also to userdoc.kemppi.com.

2.7 Connecting earth return cable and clamp

 *Keep the work piece connected to earth to reduce the risk of injury to users or damage to electrical equipment.*

 *With the MasterTig 235ACDC and 335ACDC power sources, always connect the earth return cable to the negative (-) connector.*

1. Connect the earth return cable to the power source.
2. Ensure the earth return clamp is secured tightly to the work piece or work surface.
3. Ensure that the clamp's contact surface is as large as possible.

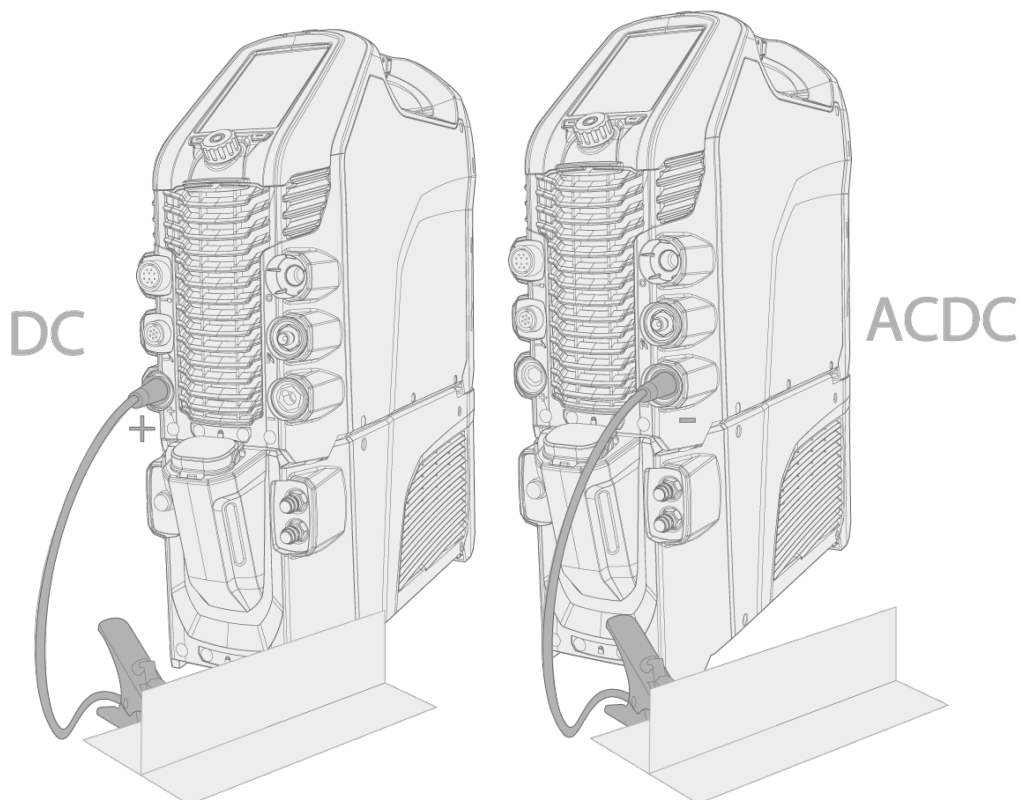

DC = MasterTig 325DC and 425DC

ACDC = MasterTig 235ACDC and 335ACDC.

 *With the DC power source, in MMA welding only, the earth return cable can also be connected to the negative (-) connector, depending on the application.*

2.8 Connecting MMA electrode holder

1. Connect the MMA electrode holder to the (+) connector on the power source.
2. Connect the earth return cable to the (-) connector on the power source.
3. Ensure the earth return clamp is secured tightly to the work piece or work surface.
4. Ensure that the clamp's contact surface is as large as possible.

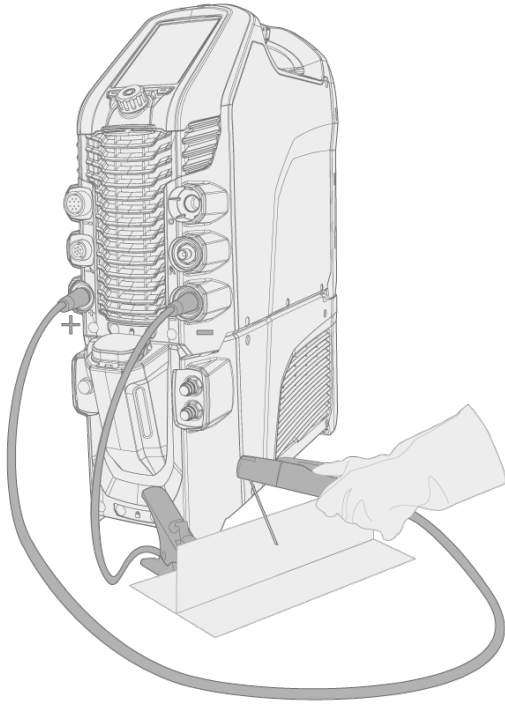

i With the DC power source, in MMA welding only, the cables can also be connected the other way round, depending on the welding polarity.

2.9 Installing remote control

Remote controls are optional. To enable remote operation, set the **Remote control mode** in the control panel settings. For MTP23X and MTP33X control panels, refer to MTP23X/33X "Settings" on page 34 and for MTP35X control panel, refer to MTP35X "Settings view" on page 56.

 When the Remote mode is selected on the control panel, and both, wireless and wired, remotes are connected, the wired remote will be used.

 Refer to the (+) and (-) signs on the battery holder and in the remote for the correct positioning of batteries.

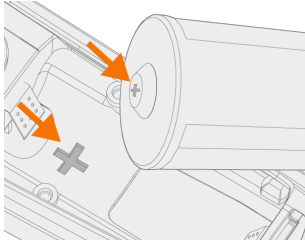

Tools:

- Screwdriver, Torx head (T15).

Wireless hand remote control (HR45)

1. Take the remote control battery holder out. Install the batteries (3 x AAA) and put the holder back into the remote.

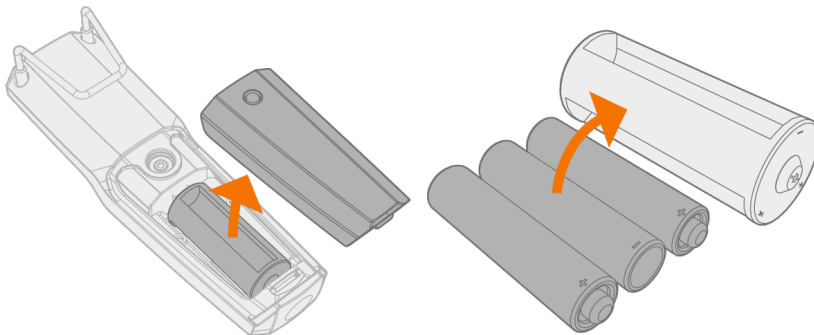

2. Turn on the **Wireless remote** in the control panel settings. For MTP23X and MTP33X control panels, refer to MTP23X/33X "Settings" on page 34 and for MTP35X control panel, refer to MTP35X "Settings view" on page 56.
3. Keeping the wireless remote close to the power source, long press (3 sec.) the wireless remote pairing button on the remote.

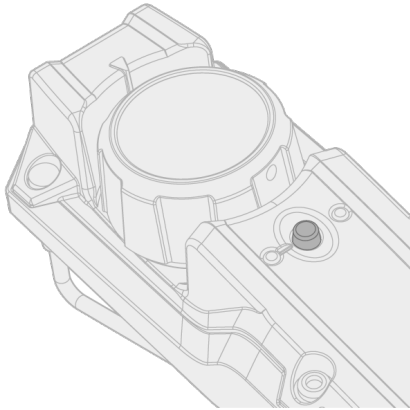

4. Once connected, the blue LED on the left of the connection button is lit. The green LED blinks when the battery is low.

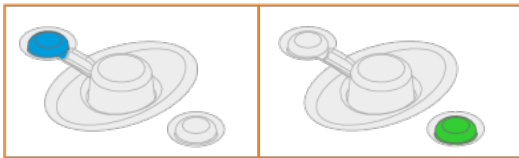

5. To enable remote operation, select Remote mode in the control panel settings.

Remote control with cable (HR43, FR43)

1. Connect the remote control cable to the power source.

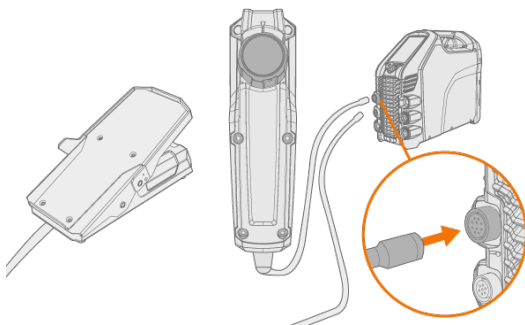

Wireless foot pedal (FR45)

 Refer to the (+) and (-) signs on the battery holder and in the remote for the correct positioning of batteries.

1. Take the foot pedal battery holder out. Install the batteries (3 x AAA) and put the holder back into the foot pedal.

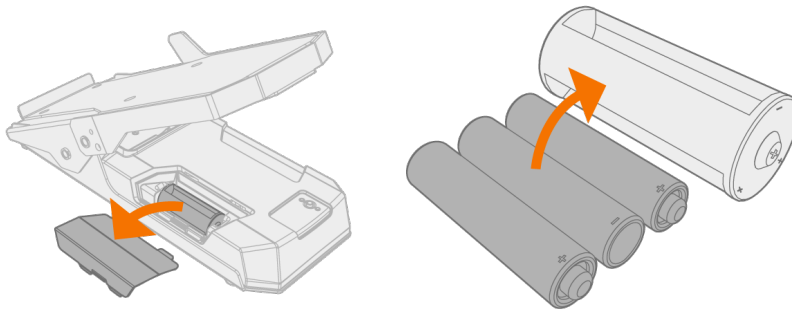

2. Turn on the **Wireless remote** in the control panel settings. For MTP23X and MTP33X control panels, refer to MTP23X/33X "Settings" on page 34 and for MTP35X control panel, refer to MTP35X "Settings view" on page 56.
3. Keeping the wireless remote close to the power source, long press (3 sec.) the wireless remote pairing button on the foot pedal.

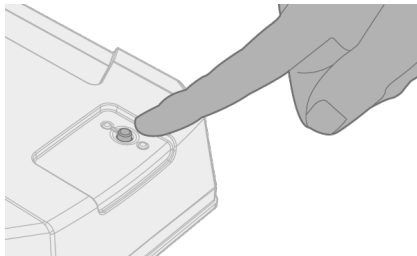

4. Once connected, the blue LED next to the button is lit. The green LED blinks when the battery is low.

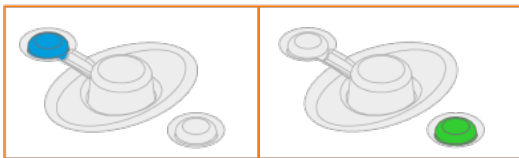

Tip: You can set minimum and maximum values for the remote current adjustment in the control panel settings.

2.10 Installing gas bottle

! Handle gas bottles with care. There is a risk of injury if the gas bottle or the bottle valve is damaged!

i If a transport unit with a gas bottle rack is used, install the gas bottle on the transport unit first, then make the connections.

Use inert gas, such as argon, helium or argon-helium mixture, as a shielding gas in TIG welding. Make sure that the gas flow regulator is suitable for the gas type used. The flow rate is set according to the welding current, joint form and the size of the electrode.

A suitable flow rate for argon is normally 5 – 15 l/min. If the gas flow is not correctly set, this will increase the risk of defects in the weld (weld porosity). Spark ignition becomes more difficult if the gas flow is too high.

Contact your local Kemppi dealer for choosing the gas and the equipment.

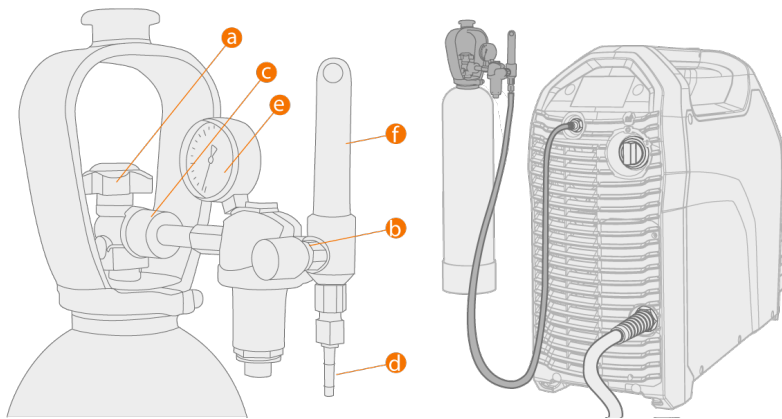

- a.** Gas bottle valve
- b.** Flow regulation screw
- c.** Connecting nut
- d.** Hose connector
- e.** Gas bottle contents indicator
- f.** Gas flow meter

! Always secure the gas bottle properly in an upright position to a special holder on the wall or on the welding equipment cart. Always keep the gas bottle valve closed when not welding. If the machine will be out of use for a long time, unscrew the pressure regulation screw.

i Do not use the whole contents of the bottle.

i Use a suitable shielding gas for the welding application.

i Always use an approved and tested regulator and flow meter.

2.11 Installing gas bottle on cart

1. P45MT only: Tilt the pivoting gas bottle rack down against the floor for easier gas bottle mounting.

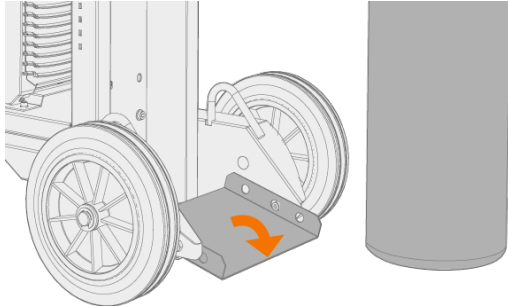

2. Move the gas bottle onto the rack.

>> With P45MT, tilt the gas bottle back and pull the cart towards the gas bottle and push the top of the gas bottle forwards. The pivot plate assists to lift the bottle into upright position.

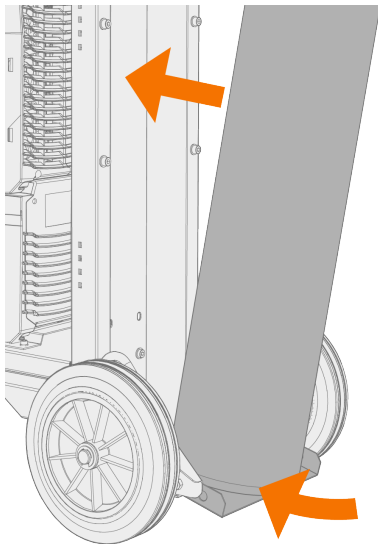

3. Secure the gas bottle in place with a strap or a chain. Use the dedicated fixing points in the cart.

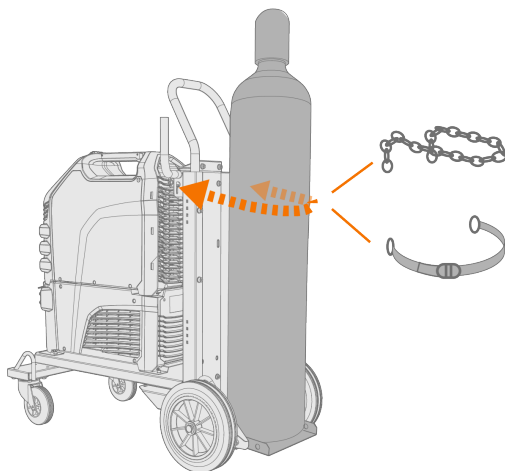

2.12 Moving equipment by lifting

If you need to lift MasterTig welding equipment, pay special attention to the safety measures. Also follow the local regulations. MasterTig welding equipment can be lifted with a mechanical hoist when the equipment is installed securely on the cart.

 *If a gas bottle is installed on cart, DO NOT attempt to lift the cart with the gas bottle in place.*

 *DO NOT attempt to lift the equipment with a hoist from the handle.*

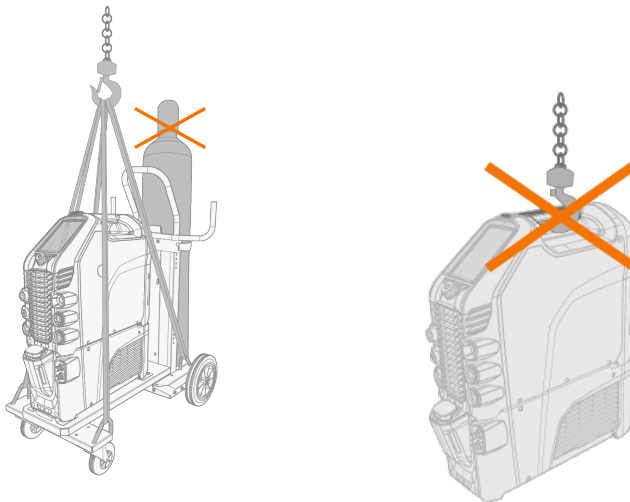

4 wheel cart (P45MT):

1. Ensure that the welding equipment is properly secured to the cart.
2. Connect the 4-legged chain or straps from the hoist hook to the four lifting points on the cart on both sides of the welding equipment.

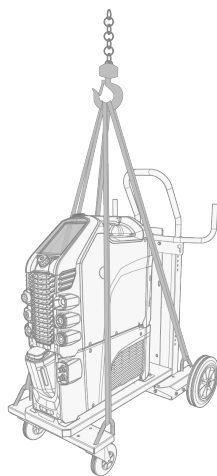





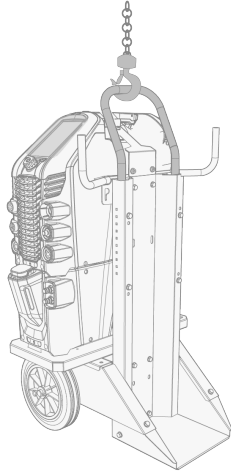

2 wheel cart (T25MT):

1. Ensure that the welding equipment is properly secured to the cart.
2. Connect the hoist hook to the lifting handle on the cart.



3. OPERATION

Before using the equipment, ensure that all the necessary installation actions have been completed according to your equipment setup.

-  *Welding is forbidden in places where there is an immediate fire or explosion hazard!*
-  *Welding fumes may cause injury, take care of sufficient ventilation during welding!*
-  *Check that there is enough space for cooling air circulation in the machine vicinity.*
-  *If the welding equipment is left unused for a longer period, disconnect the mains plug from the mains.*
-  *Do not use the mains plug as a power ON/OFF switch.*
-  *Always check before use that interconnecting cable, shielding gas hose, earth return cable/clamp and mains cable are in serviceable condition. Ensure that the connectors are correctly fastened. Loose connectors can impair welding performance and damage connectors.*

For technical data and general guidance for selecting initial TIG welding parameters, refer to "TIG guide tables" on page 82.

For troubleshooting, refer to "Troubleshooting" on page 68.

Tip: There is a small locker inside the power source handle, under the lid, that can be used for storing small consumables. The device QR code can also be found here.

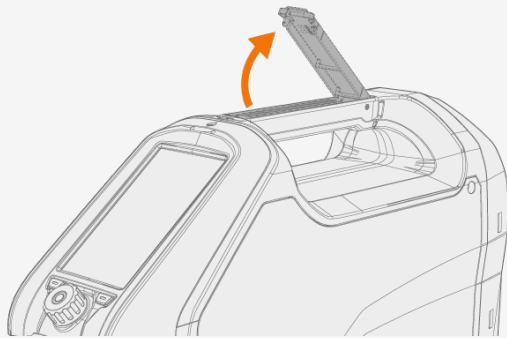

3.1 Operating power source

1. Turn the power source ON. The power switch is located in the rear.

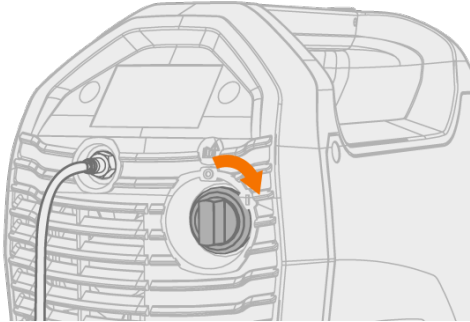

2. Depending on your control panel type, wait approximately 15 seconds for the system to start up.

For control panel operation, refer to:

- "Operating control panels MTP23X and MTP33X" on the next page
- "Operating control panel MTP35X" on page 40

3.2 Operating control panels MTP23X and MTP33X

MTP23X and MTP33X control panels include physical push buttons for the most common setup and adjustment features as well as a small digital display for showing the adjustment values and more in-depth settings.

 *MTP23X control panel has only the DC current mode available, whereas MTP33X control panel includes both, AC and DC current modes.*

Controls:

The MTP23X and MTP33X control panels are used with a control knob and with two function buttons in the bottom section of the front cover as well as with dedicated push buttons on the panel itself. The control knob can be turned and used also as a push button according to the current selections. Settings and adjustment values are shown on the digital display embedded in the control panel.

Control panel MTP33X on the left and control panel MTP23X on the right:

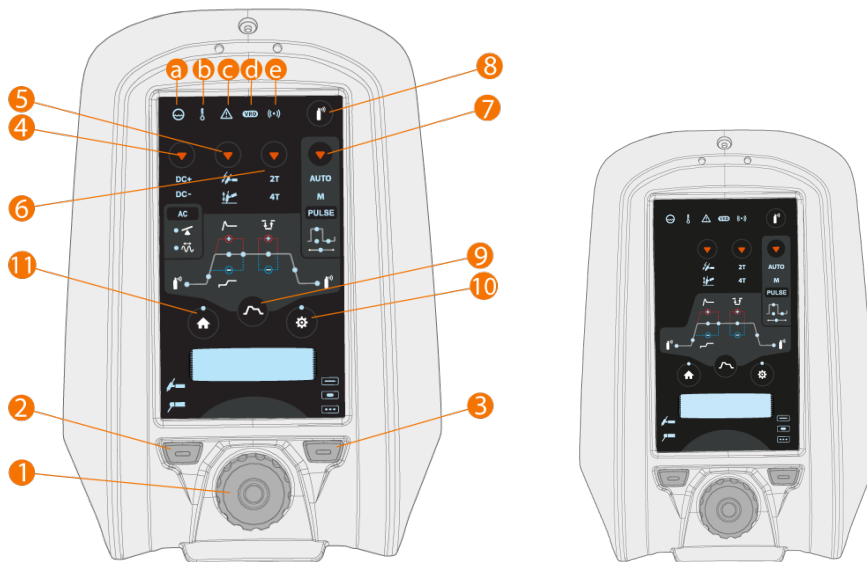

1. Control knob

- In home mode this adjusts the welding current (A)
- Used to navigate within the control panel's embedded display and settings
- When the green light is lit in the knob center, the knob also functions as a push button for selection

2. Welding process selection button (left function button)

- Switches between welding processes: TIG / MMA

3. Welding mode selection button (right function button)

- Switches between welding modes: Continuous / Spot / MicroTack

4. MTP33X control panel only: Current mode selection button

- Short press switches between current modes: AC / DC- / Mixed current (AC/DC-)
- Long press switches to DC+ mode

5. Ignition mode selection button

- Switches between different ignition modes: Lift TIG / High frequency (HF) ignition

6. Trigger logic selection button

- Switches between the trigger logics: 2T / 4T

7. Pulse mode selection button

- Selects the pulse mode or turns the pulse off: Auto / Manual / Pulse off

8. Gas test button

- Flushes the gas line without ignition and welding
- Pressing the Gas test button starts the gas test with default time. Gas test time can be adjusted by turning the control knob (1) during the gas test: 0 s ... 60 s, step 1 s (Default: 20 s)
- Gas test can be stopped by pressing the button again.

9. Start & stop sequence button

- Toggles between Start & stop sequence settings: Pregas / Upslope / Hot start level / Hot start time / Minilog (4T only) / Downslope / Postgas
- If AC mode is on, AC frequency and AC balance settings can be accessed
- If Pulse mode is on, Pulse current, Pulse ratio, Base current and Pulse frequency settings can be accessed
>> In the Pulse Auto mode, these settings can be viewed only.

10. Settings button

- Opens the settings menu
- Advanced settings can be accessed with a long press of the button.

 *Settings menu content depends on the currently selected welding process and mode.*

11. Home button

- Returns you to the initial work mode where the welding current (A) can be adjusted

Lights and symbols:

a. Cooling unit

- Green: Cooling unit is connected and running
- Red: Cooling unit is connected, but there is a problem (e.g. with coolant circulation)

b. Operating temperature

- Yellow: Welding equipment has overheated

c. General notification

- Yellow: There is an error that requires attention
- Red: There is a fault that prevents welding
- The error code is shown on the display. If the error does not prevent welding, this error code can be dismissed, but the notification light stays lit.

d. VRD (voltage reduction device)

- Green: VRD is on
- Red (blinking): There is a fault with VRD that prevents welding
- Not lit: VRD is off

e. Wireless device

- Blue: Wireless device is connected
- Blue, blinking: Pairing in progress.

 *In error situations, an error code is displayed. Refer to "Troubleshooting" on page 68 for more information on the error in question.*

 *For welding process and control panel feature descriptions, refer to "Welding processes and features" on page 83.*

Control panel parameter adjustment:

- "Home" below
- "Start & stop sequence" below
- "Settings" on page 34.

3.2.1 Home

'Home' is the control panel work mode after the initial machine and control panel start-up. When Home is selected, the welding current can be adjusted by turning the control knob.

**To adjust welding current:**

1. Press the Home button (11).
2. Turn the control knob (1) to adjust the current. Current (A) is shown on the display.

3.2.2 Start & stop sequence

The parameters diagram tool makes base parameter identification and setting easy. From pre-gas time to post-gas time and everything in between, you can quickly select and adjust the parameter value.



 The AC/DC function (4) is not available with the MTP23X control panel.

To select and adjust Start & stop parameters:

1. Press the Start & stop button (9) to enter the parameter settings.
2. Browse through the curve / menu parameters by turning the control knob (1).
3. Select the parameter for adjusting by pressing the control knob button (1).
4. Adjust the selected parameter by turning the control knob (1).
5. Close the parameter setting by pressing the control knob again (1).

To select and adjust AC and/or Pulse parameters:

1. Press the Current mode selection button (4) to switch to AC mode.
2. Press the Pulse mode selection button (7) to switch between Pulse modes.
3. Press the Start & stop button (9) to enter the parameter settings.
4. Browse to the AC or Pulse settings in the parameter menu by turning the control knob (1).
5. Select the AC or Pulse parameter for adjustment by pressing the control knob button (1).
6. Adjust the selected parameter's value by turning the control knob (1).
7. Close the parameter setting by pressing the control knob button (1).

 The Current mode and Pulse mode selections have an effect on the Start & stop menu contents.

Adjustable parameters in continuous welding:

Parameter	Value	Description
Pre gas	Min/Max = 0.0 s ... 9.9 s, Auto, 0.1 s step (Default = Auto)	Welding function that starts the shielding gas flow before the arc ignites. This ensures that the metal does not come into contact with air at the start of the weld. Time value is preset by the user. Used for all metals, but especially for stainless steel, aluminum and titanium. This adjustment is not available when the Lift TIG ignition is turned on.
Upslope	Min/Max = 0.0 s ... 5.0 s, 0.1 s step (Default = 0.0 s)	Welding function that determines the time, during which the welding current gradually increases to desired welding current level at the start of the weld. The value for the upslope time is preset by the user. The value zero means the function is off.
Hot start level	Min/Max = -80 % ... +100 %, 1 % step (Default = Off), Value '0' = Hot start off	Hot start: Welding function that uses higher welding current at the start of the weld. After the Hot start period the current drops to normal welding current level. The values for Hot start current level and its duration are preset manually. This facilitates the start of the weld especially with aluminum materials.
Hot start time	Min/Max = 0.1 s ... 9.9 s, 0.1 s step (Default = 1.2 s)	This adjustment is not available when Hot start is off. Hot start time cannot be adjusted when 4T trigger logic is selected.
Minilog	Min/Max = -99 % ... +125 %, 1 % step (Default = Off), Value '0' = Minilog off	TIG welding function, which allows using the torch switch to change between the welding current and Minilog current. Parameters are preset by the user. Welding over tack welds is one application, and it also functions as a "pause current" when the welding position changes for example. This adjustment is not available when the 2T trigger logic is selected.
Downslope	Min/Max = 0.0 s ... 15.0 s, 0.1 s step (Default = 0.1 s)	Welding function that determines the time, during which the welding current gradually decreases to the end current level. The value for the downslope time is preset by the user. The value zero means the function is off.
Post gas	Min/Max = 0.0 s ... 30.0 s, Auto, 0.1 s step (Default = Auto)	Welding function that continues the shielding gas flow after the arc has extinguished. This ensures that the hot weld does not come into contact with air after the arc is extinguished, protecting the weld and also the electrode. Used for all metals. Especially stainless steel and titanium require longer post gas times.

Adjustable parameters in spot welding:

Parameter	Value	Description
Pre gas	Min/Max = 0.0 s ... 9.9 s, Auto, 0.1 s step (Default = Auto)	Welding function that starts the shielding gas flow before the arc ignites. This ensures that the metal does not come into contact with air at the start of the weld. Time value is preset by the user. Used for all metals, but especially for stainless steel, aluminum and titanium. This adjustment is not available when the Lift TIG ignition is turned on.
Upslope	Min/Max = 0.0 s ... 5.0 s, 0.1 s step (Default = 0.0 s)	Welding function that determines the time, during which the welding current gradually increases to desired welding current level at the start of the weld. The value for the upslope time is preset by the user. The value zero means the function is off.
Downslope	Min/Max = 0.0 s ... 15.0 s, 0.1 s step (Default = 0.1 s)	Welding function that determines the time, during which the welding current gradually decreases to the end current level. The value for the downslope time is preset by the user. The value zero means the function is off.
Post gas	Min/Max = 0.0 s ... 30.0 s, Auto, 0.1 s step (Default = Auto)	Welding function that continues the shielding gas flow after the arc has extinguished. This ensures that the hot weld does not come into contact with air after the arc is extinguished, protecting the weld and also the electrode. Used for all metals. Especially stainless steel and titanium require longer post gas times.

Adjustable parameters in MicroTack welding:

Parameter	Value	Description
Pre gas	Min/Max = 0.0 s ... 9.9 s, Auto, 0.1 s step (Default = Auto)	Welding function that starts the shielding gas flow before the arc ignites. This ensures that the metal does not come into contact with air at the start of the weld. Time value is preset by the user. Used for all metals, but especially for stainless steel, aluminum and titanium. This adjustment is not available when the Lift TIG ignition is turned on.
Post gas	Min/Max = 0.0 s ... 30.0 s, Auto, 0.1 s step (Default = Auto)	Welding function that continues the shielding gas flow after the arc has extinguished. This ensures that the hot weld does not come into contact with air after the arc is extinguished, protecting the weld and also the electrode. Used for all metals. Especially stainless steel and titanium require longer post gas times.

Adjustable parameters in AC mode:

Parameter	Value	Description
Balance	-60 % ... 0 % (Default = -25%)	Function to adjust the positive and negative current cycles in AC TIG welding. Low percentage means that, on average, the welding current is more on the negative side, and high percentage that, on average, the welding current is more on the positive side.
AC Frequency	30 Hz ... 250 Hz (Default = 60 Hz)	Function to change the frequency of the alternating current in AC TIG welding. This setting adjusts the number of cycles per second. Used for changing the frequency of the welding current to best match the welder's preference and application.

Adjustable parameters in Pulse mode:

Parameter	Value	Description
Pulse current	2 A ... Power source max A, 1 A step *	The higher current level of the pulse cycle. In TIG welding, its main task is to create weld pool or increase the heat of the weld pool.
Pulse ratio	10 % ... 70 %, 1 % step (Default = 40 %) *	Determines how big part of the whole pulse cycle time is spent on pulse current.
Base current	10 % ... 70 %, 1 % step (Default = 20 %), amperes visible *	The lower current level of the pulse cycle. In TIG welding, its main tasks are to cool down the weld pool and to maintain the arc.
Pulse frequency	(DC): 0.2 Hz ... 300 Hz, 1 Hz step (0.2 Hz ... 10 Hz step is 0.1 Hz) (Default = 1 Hz) *	Determines how many pulse cycles are created per second (Hz).
Pulse frequency	(AC): 0.2 Hz ... 20 Hz, 1 Hz step (0.2 Hz ... 10 Hz step is 0.1 Hz) (Default = 1 Hz) *	

* Auto Pulse mode has different parameter values and they cannot be adjusted.

3.2.3 Settings



The contents of the Settings menu depend on the welding process, current mode and welding mode selected.



To select and adjust parameters in Settings menu:

1. Press the parameter settings button (10) to enter the menu.
2. Browse through the menu parameters by turning the control knob (1).
3. Select a parameter for adjustment by pressing the control knob button (1).
4. Adjust the selected parameter by turning the control knob (1).
5. Close the parameter setting by pressing the control knob button (1).

To enter advanced Settings menu:

Press the Settings button (10) for 5 seconds.

 Rarely used settings items are hidden by default. Those are available in the advanced settings menu.

Settings:

Parameter	Parameter value	Description
Latest weld	Current, voltage, arc time	This settings item shows last weld data values.
AC Waveform	Sine / Optima / Square (Default: Optima)	Function to change the wave form of the alternating current in AC TIG welding. Three options are available: sine, square and Optima. The wave form affects the shape of weld bead, penetration of the weld and the noise of the welding process. Select the one that suits the application.

Parameter	Parameter value	Description
Spot time	0.1 s ... 150.0 s, step 0.1 / 1.0 s (Default = 2.0 s)	Spot welding: TIG welding function, which automatically produces a weld of predefined duration. Parameters are preset by the user. This function is used for attaching two pieces of materials with tack welds, for example joining thin sheets with low heat input.
MIX TIG AC ratio	10 % ... 90 %, step 1 % (Default = 50 %)	MIX TIG: TIG welding function, where AC TIG and DC TIG processes alternate in predefined manner. Parameters are preset by the user according to welding application. Used especially for optimizing welding of aluminum materials of dissimilar thicknesses.
MIX TIG cycle time	0.1 s ... 1.0 s, step 0.1 s (Default = 0.6 s)	
MIX TIG DC level	50 % ... 150 %, step 1 % (Default = 100 %)	
MicroTack spot time	1 ms ... 200 ms, step 1 ms (Default = 10 ms)	
MicroTack pause time	50 ms ... 500 ms, step 1 ms (Default = 50 ms)	MicroTack: TIG welding function, which optimizes the spot welding characteristics. Used for tack welding of thin sheets or materials of different thicknesses. Allows fast and easy creation of clean tack welds with minimum heat input.
MicroTack spot count	1 ... 5, Endless (Default = 1)	
Arc force	-10 ... +10, step 1 (Default = 0)	Adjusts short circuit dynamics (roughness) of MMA welding by changing, for example, current levels.
Hot start	-10 ... +10, step 1 (Default = 0)	Welding function that uses higher welding current at the start of the weld. After the Hot start period the current drops to normal welding current level. The values for Hot start current level and its duration are preset manually. This facilitates the start of the weld especially with aluminum materials.
VRD	OFF / ON (Default = OFF)	VRD (Voltage Reduction Device): A safety device used in welding equipment to reduce the open-circuit voltage to maintain below a certain voltage value. This reduces the risk of electric shock particularly in dangerous environments, such as closed or damp spaces. VRD may also be required by law in certain countries or regions. In AU VRD version: Default ON, OFF disabled.
MMA Antifreeze	OFF / ON (Default = ON)	A function which automatically decreases the welding current significantly when electrode is touching the workpiece. Can be used for avoiding MMA electrode getting too hot when it's in contact with the workpiece.
HF spark force	50 % ... 110 %, Step 1 % (Default 100 %)	Adjusts the voltage of the high frequency spark used in ignition.

Parameter	Parameter value	Description
TIG antifreeze	OFF / ON (Default = OFF)	A function which automatically decreases the welding current significantly when electrode is touching the workpiece. Can be used for example to avoid unwanted dilution from electrode to welded metal.
Remote mode	OFF / Remote / Torch (Default = OFF)	
Remote control min	Min = "Current limit min", Max = "Current limit max"	
Remote control max	Min = "Current limit min", Max = "Current limit max"	
Wireless remote	Cancel / Start (Start pairing)	
Water cooler	OFF / Auto / ON (Default: Auto)	
Weld data time	OFF / 1 s ... 10 s, step 1 s (Default = 5 s)	This defines if and how long the weld data summary is shown after each weld.
Display off	5 min ... 120 min, step 1 min (Default = 5 min)	
Date	Date setting (DD/MM/YYYY)	Set the day by pressing and turning the control knob. Once the day is set, press the control knob button to set the month etc.
Time	Time setting (HH:MM)	Set the hour by pressing and turning the control knob (use 24 h format). Once the hour is set, press the control knob button to set the minutes.
Language		Select language from the list.
Time counter		Total arc time and power on time.
Time counter (since date)		Total arc time and power on time since last reset.
Reset counter		Time counter reset.
4T trigger logic	4T MLOG / 4T LOG / 4T LOG+ (Default = 4T MLOG)	Trigger operation mode of a welding torch. When you press the trigger down in 4T mode, shielding gas starts to flow but the arc won't ignite until you release the trigger. To stop welding you press the trigger down again and then release it to extinguish the arc.

Advanced settings (hidden in standard view):

Parameter	Value	Description
Current limit min	TIG: 2 A / MMA: 8 A, step 1 A *	
Current limit max	TIG: power source's nominal value / MMA: power source's max. MMA current, step 1 A *	
Balance min	-99 % ... 0 % (Default = -60 %)	Sets the minimum value for AC balance setting.

Parameter	Value	Description
Balance max	0 % ... 20 % (Default = 0 %)	Sets the maximum value for AC balance setting.
Lift TIG current	5 A ... 40 A / Auto (Default = Auto)	Contact current in the beginning of Lift TIG ignition.
Cooler flow watch	OFF / ON (Default = ON)	
Positive ignition current	30 % ... 150 % / Auto, step 1 % (Default = Auto)	Adjusts the current level of the positive ignition sequence. Only in ACDC power sources (TIG).
Negative ignition current	(AC/DC): 100 % ... 300 % / Auto, Step 1 % (Default = Auto)	Adjusts the current level of the negative ignition sequence (TIG).
Ignition current	(DC): 100 % ... 300 % / Auto, step 1 % (Default = Auto)	
Positive ignition time	0 ms ... 50 ms / Auto, step 10 ms (Default = Auto)	Adjusts the length of the positive ignition sequence. Only in ACDC power sources (TIG).
Negative ignition time	(AC/DC): 0 ms ... 950 ms / Auto, step 10 ms (Default = Auto)	Adjusts the length of the negative ignition sequence (TIG).
Ignition time	(DC): 0 ms ... 950 ms / Auto, step 10 ms (Default = Auto)	
Slight upslope	OFF / ON (Default = OFF)	This is a function that automatically creates a slight upslope to prevent electrode wearing caused by sudden current rises with high welding currents. This function has an effect only when the welding current is 100 A or more.
Startup level	5 % ... 40 %, step 1 % (Default = 10 %)	The point of welding current where the upslope begins.
Downslope cut level	5 % ... 40 %, step 1 % (Default = 10 %)	The point of welding current where the downslope ends.
2T downslope cut	OFF / ON (Default = OFF)	This is a function that allows the user to end the current downslope ramp with a quick press of the torch switch.
Nonlinear downslope	0 % ... 50 %, step 1 % (Default = 0 %)	Determines a point to which current goes down as fast as possible and then starts normal downslope.
Current freezing	OFF / ON (Default = OFF)	Welding current can be freed to a certain level during downslope by pressing the trigger.
AC phase swap current	5 A ... 20 A / Auto	Changes the welding current point where crossing the zero begins. Affects only AC TIG.
Info		Machine type, serial number.
Software version		Power source and control panel software version number.
Factory reset	Cancel / Reset (Default = Cancel)	Resets to TIG, DC-, 50 A, HF, Pulse OFF (other values as per default). Once the factory reset is complete, the power source must be restarted manually.

* Current range adjustable by welder in TIG welding:

- 2 A ... 130 A, 1 A step (MasterTig 235, limited supply mode)
- 2 A ... 235 A, 1 A step (MasterTig 235)
- 2 A ... 305 A, 1 A step (MasterTig 325, 335)
- 2 A ... 405 A, 1 A step (MasterTig 425)
- Default = 3 A ... Nominal value of the power source.

* Current range adjustable by welder in MMA welding:

- 8 A ... 85 A, 1 A step (MasterTig 235, limited supply mode)
- 8 A ... 185 A, 1 A step (MasterTig 235)
- 8 A ... 255 A, 1 A step (MasterTig 325, 335)
- 8 A ... 355 A, 1 A step (MasterTig 425)
- Default = 10 A ... MMA maximum current of the power source.

3.3 Operating control panel MTP35X

Control panel MTP35X has a 7" TFT LCD display. In addition to MTP23X and MTP33X control panels' features, the MTP35X control panel includes memory channels, Weld Assist, option for more customized welding processes, assisting graphics and functions such as double pulse TIG, search arc and tail arc.

Controls:

The control knob can be turned and used as a push button to select functions and items on the screen. In addition to the control knob, there are two function buttons just below the panel display on both sides of the control knob.



1. Control knob and control knob button

- In home view, turning this knob adjusts the welding current (A)
- In other views, turning this knob switches between adjustable parameters and adjusts the selected parameter's value
- The control knob functions also as a push button, when the green light is lit in the knob center
- Used to navigate through the control panel views and selections.

2. Menu button (left function button)

- This is used to access the view menu
- With certain control panel settings and features this also acts as a 'back' or 'cancel' button.

3. Custom function button (right function button)

- This button can be used as a user-programmable shortcut
- With certain control panel settings and features this also acts as a 'back' or 'cancel' button.

 The MTP35X control panel displays notifications, warnings and error messages with additional information directly on the screen. Refer also to "Troubleshooting" on page 68 section in this manual for more information on solving error situations.

 For welding process and control panel feature descriptions, refer to "Welding processes and features" on page 83.

Control panel views:

- "Home view" on the next page
- "Weld Assist view" on page 42

- "Memory channels view" on page 47
- "Start & stop sequence view" on page 47
- "Pulse view" on page 52
- "Current mode view" on page 54
- "Settings view" on page 56
- "Info view" on page 60

To navigate between different control panel views:

1. Press the menu button (2).
2. Browse to the target view by turning the control knob (1).
3. Select the view by pressing the knob (1).

Tip: You can switch between the home view and the previously used view by long pressing the menu button (2).

3.3.1 Home view

Home view is the control panel work mode after the initial machine and control panel start-up. When in Home view, the welding current can be adjusted directly by turning the control knob.

Depending on your welding settings, the following are shown:

- Welding current (A)
- Current mode (AC, DC-, DC+, MIX)
- Pulse mode: Auto / Selected value Hz (manual)
- Start & stop diagram
- Welding mode indicated by the diagram shape: Continuous, Spot or MicroTack
- Memory channel used
- Selected trigger logic, ignition mode, remote mode and welding process
- Warning and notification symbols.



1. Welding process (TIG/MMA)
2. Trigger logic (2T/4T)
3. Ignition mode (Lift TIG ignition)
4. Wireless remote and its battery status
5. Remote mode (ON/OFF).

Warning and notification symbols:**a. Cooling unit**

- Green: Cooling unit is connected and running
- Red: Cooling unit is connected, but there is a problem (e.g. coolant circulation is restricted)

b. General notification

- Yellow: This is a warning that requires attention
- Red: There is an error that prevents welding
- Error code is shown below the symbol

c. Operating temperature

- Red: Welding equipment has overheated

d. Low-voltage network (MasterTig 235 only)

- Yellow: Power source is connected to a low-voltage network (110 V) and the maximum welding current is restricted to 130 A in TIG welding and to 85 A in MMA welding.

 *The power source checks the network voltage only when powering up. In case the network voltage changes, the power source must be turned off and on again.*

e. VRD (voltage reduction device)

- VRD symbol on: VRD is on
>> This is always on in power source models where the VRD function is locked on.
- VRD symbol red (blinking): There is a fault with VRD that prevents welding
- VRD symbol off: VRD is off.

Tip: You can switch between the home view and the previously used view by long pressing the menu button.

3.3.2 Weld Assist view

Weld Assist is a wizard-like utility for easy selection of welding parameters. The utility walks the user step-by-step through the selection of required parameters, presenting the selections in an easily understandable way for a non-technical user.

The Weld Assist feature is available for both TIG and MMA welding. In Weld Assist, the selections are made with the control knob (1) and with the two function buttons (2, 3):

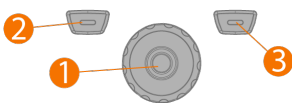

Using Weld Assist with TIG welding

1. Go to the **Weld Assist** view and select 'Start' with the control knob button (1).

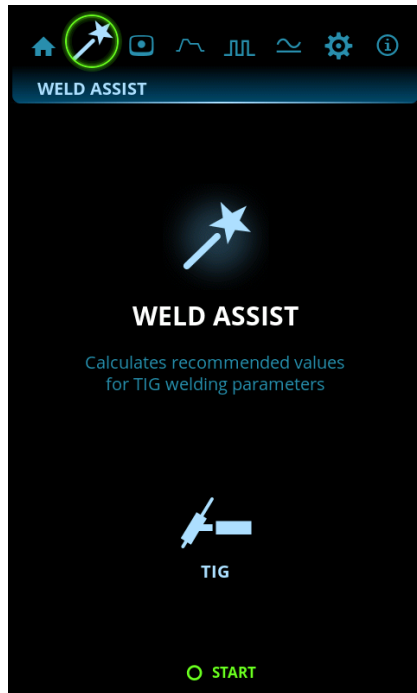

2. Select:

- >> The material you are about to weld: Fe (mild steel) / Ss (stainless steel) / Al (aluminum).
- >> The welded material's thickness (0.5 ... 10 mm).
- >> The welding joint type: butt joint / corner joint / edge joint / lap joint / fillet joint / tube joint / tube+plate joint.
- >> The welding position: PA / PB / PC / PD / PE / PF / PG.





 With MasterTig DC power sources, the aluminum (Al) selection is not available as a welded material.

3. Confirm the Weld Assist's recommendation for welding settings by selecting 'Apply'.

Tip: You can go back step by step in Weld Assist by pressing the left function button (2). Selecting Cancel with the right function button (3), you can cancel Weld Assist recommendations and return to the beginning.

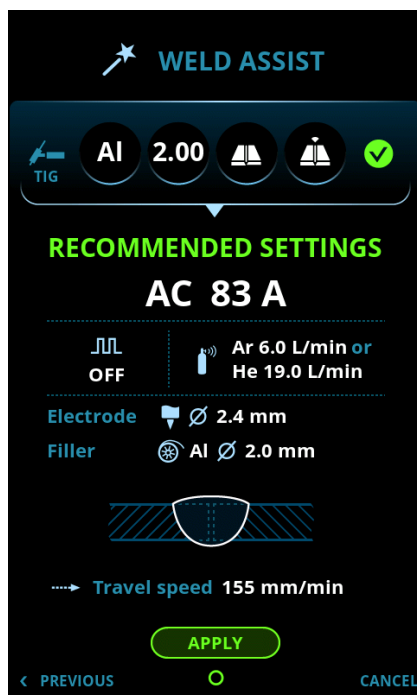

Weld Assist automatically sets the following parameters for you:

- Current mode: AC / DC-
- Current: Depends on the machine used
- Pulse (if used): Frequency
- AC and Start & stop parameters: Set to default.

 All these parameters can still be modified as per normal for the actual welding.

Weld Assist gives you a recommendation for these:

- Shielding gas flow: "Argon" + l/min and "Helium" + l/min
- Electrode: Diameter
- Filler (if used): Material and diameter
- Number of passes: Number and/or visualization
- Travel speed: mm/min.

Using Weld Assist with MMA welding

1. Go to the **Weld Assist** view and select 'Start' with the control knob button.

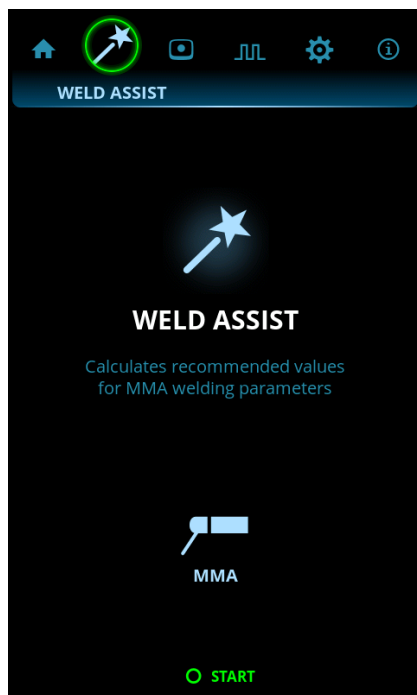

2. Select:
 - >> The electrode type: Fe-Basic / Fe-Rutile / High Eff. / Ss (stainless steel)/Inox.
 - >> The electrode diameter (1.6 ... 6 mm).
 - >> The welding joint type: butt joint / corner joint / lap joint / fillet joint / tube joint / tube+plate joint.

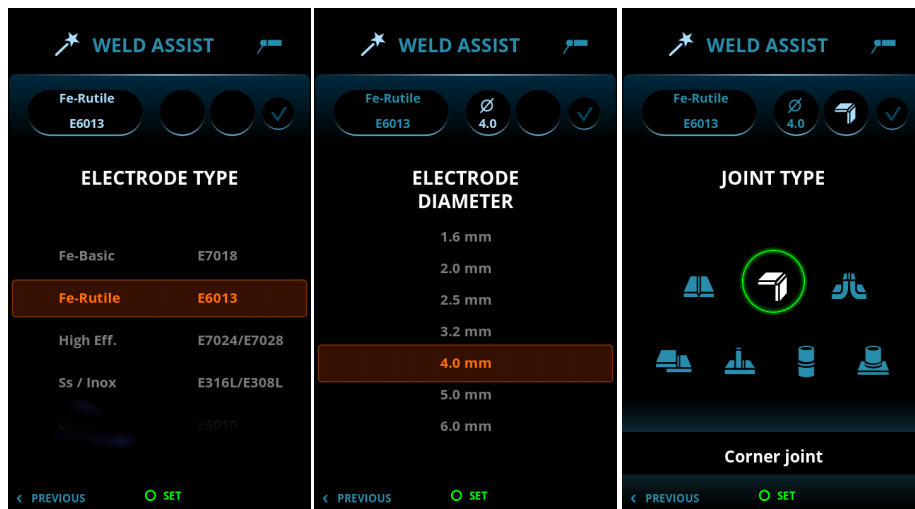

3. Confirm the Weld Assist's recommendation for welding settings by selecting 'Apply'.

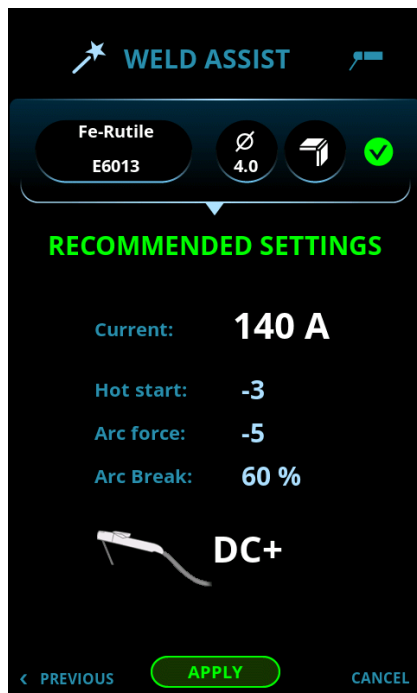

Weld Assist automatically sets the following parameters for you:

- Current: Depends on the machine used
- Hot start
- Arc force
- Arc break
- DC+ indicates polarity (in this case the electrode holder is connected to the positive (+) DIX connector).

 All these parameters can still be modified as per normal for the actual welding.

3.3.3 Memory channels view

Memory channel is a place to store predefined welding parameter settings for future use. A welding machine can include a number of preset and user-defined channels.

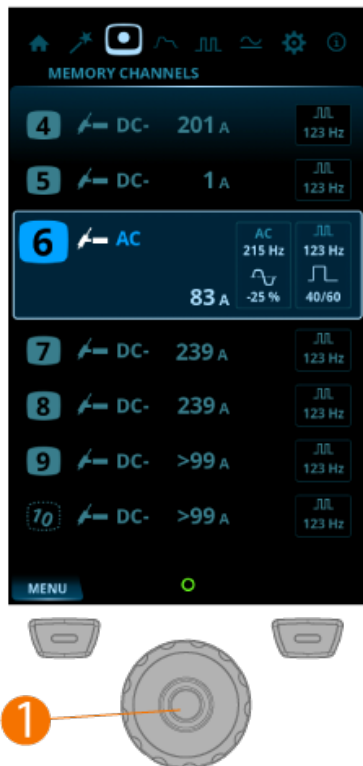

To browse through channels and select channels:

1. Go to the **Channels** view.
2. Turn the control knob (1) to switch between channels. The highlighted channel is automatically selected.

To save or delete channels:

1. Turn the control knob (1) to highlight a channel.
2. Open the channel actions menu by pressing the control knob button (1). The available actions are shown: Cancel, Save changes, Save to and Delete.
3. Select an action with the control knob (1).

3.3.4 Start & stop sequence view

The parameters diagram view makes base parameter identification and setting easy. From pre-gas time to post-gas time and everything in between, you can quickly select and adjust the needed parameter value.

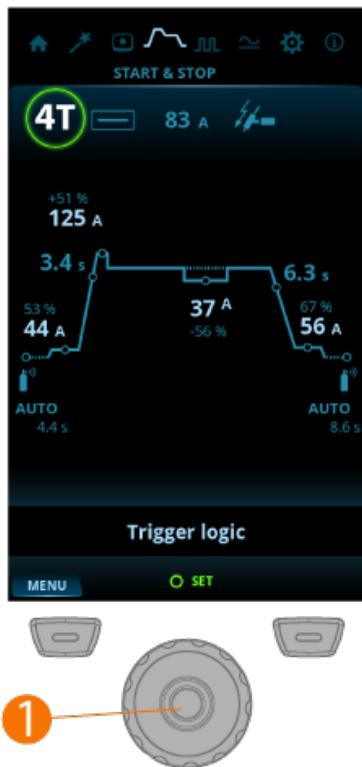

To adjust parameters:

1. Go to the **Start & stop** sequence view.
2. Turn the control knob (1) to browse through the parameters.
3. Select a parameter for adjusting by pressing the control knob button (1).
4. Adjust the parameter by turning the control knob (1).
5. Close the parameter setting by pressing the control knob (1).

Adjustable parameters in all welding modes:

Parameter	Value	Description
Trigger logic	2T / 4T / 4T LOG / 4T LOG + Minilog (Default = 2T)	Welding torches have two alternative operation modes: 2T and 4T. They differ in the way how the trigger operates. In 2T mode you hold the trigger down while welding, whereas in 4T mode you press and release the trigger to start or to stop welding and to use special trigger functions, such as Minilog.

Parameter	Value	Description
Welding mode	Continuous / Spot / MicroTack	<p>Continuous welding: Normal TIG welding which doesn't have any pause times.</p> <p>Spot welding: TIG welding function, which automatically produces a weld of pre-defined duration. Parameters are preset by the user. This function is used for attaching two pieces of materials with tack welds, for example joining thin sheets with low heat input.</p> <p>MicroTack: TIG welding function, which optimizes the spot welding characteristics. Used for tack welding of thin sheets or materials of different thicknesses. Allows fast and easy creation of clean tack welds with minimum heat input.</p>
Welding current	Default = 50 A	
Ignition mode	Lift TIG / High frequency (HF) ignition	<p>The way in which the welding arc is ignited. In TIG welding, two ignition modes are available: High Frequency (HF) ignition and Lift TIG ignition. The HF ignition uses a voltage pulse to initiate the arc, and the Lift TIG ignition needs a physical contact between the electrode and the work piece.</p>

Adjustable parameters in continuous welding:

Parameter	Value	Description
Pre gas	0.0 s ... 10.0 s, Auto, 0.1 s step (Default = Auto)	<p>Welding function that starts the shielding gas flow before the arc ignites. This ensures that the metal does not come into contact with air at the start of the weld. Time value is preset by the user. Used for all metals, but especially for stainless steel, aluminum and titanium.</p>
Search arc	OFF / 5 % ... 90 %, step 1 % (Default = OFF)	<p>Welding function that allows using a brief low current period at the start of the weld. This enables precise start of welding. The parameters are preset by the user.</p>
Upslope	OFF / 0.1 s ... 5.0 s, 0.1 s step (Default = 0.0 s)	<p>Welding function that determines the time, during which the welding current gradually increases to desired welding current level at the start of the weld. The value for the upslope time is preset by the user. The value zero means the function is off.</p>

Parameter	Value	Description
Hot start level	-80 % ... 100 %, 1 % step (Default = OFF, 0 %)	Hot start: Welding function that uses higher welding current at the start of the weld. After the Hot start period the current drops to normal welding current level. The values for Hot start current level and its duration are preset manually. This facilitates the start of the weld especially with aluminum materials.
Hot start time	0.1 s ... 5.0 s, 0.1 s step (Default = 1.2 s)	This is not available with 4T trigger logic.
Minilog level	-99 % ... 125 %, 1 % step (Default = OFF, 0 %)	Minilog: TIG welding function, which allows using the torch switch to change between the welding current and Minilog current. Parameters are preset by the user. Welding over tack welds is one application, and it also functions as a "pause current" when the welding position changes for example.
Downslope	OFF / 0.1 s ... 15.0 s (Default = 0.1 s)	Welding function that determines the time, during which the welding current gradually decreases to the end current level. The value for the downslope time is preset by the user. The value zero means the function is off.
Tail arc	OFF / 5 % ... 90 % (Default = OFF)	Welding function that allows using a brief low current period at the end of the weld. This reduces welding defects caused by end cratering. The parameters are preset by the user. The value zero means the function is off.
Post gas	0.1 s ... 30.0 s / AUTO, 0.1 s step	Welding function that continues the shielding gas flow after the arc has extinguished. This ensures that the hot weld does not come into contact with air after the arc is extinguished, protecting the weld and also the electrode. Used for all metals. Especially stainless steel and titanium require longer post gas times.

Adjustable parameters in spot welding:

Parameter	Value	Description
Pre gas	0.0 s ... 10.0 s, Auto, 0.1 s step (Default = Auto)	Welding function that starts the shielding gas flow before the arc ignites. This ensures that the metal does not come into contact with air at the start of the weld. Time value is preset by the user. Used for all metals, but especially for stainless steel, aluminum and titanium.

Parameter	Value	Description
Upslope	OFF / 0.1 s ... 5.0 s, 0.1 s step (Default = 0.0 s)	Welding function that determines the time, during which the welding current gradually increases to desired welding current level at the start of the weld. The value for the upslope time is preset by the user. The value zero means the function is off.
Spot time	0.0 s ... 10.0 s, step 0.1 s (Default = 2.0 s)	Spot welding: TIG welding function, which automatically produces a weld of pre-defined duration. Parameters are preset by the user. This function is used for attaching two pieces of materials with tack welds, for example joining thin sheets with low heat input.
Downslope	OFF / 0.1 s ... 15.0 s (Default = 0.1 s)	Welding function that determines the time, during which the welding current gradually decreases to the end current level. The value for the downslope time is preset by the user. The value zero means the function is off.
Post gas	0.1 s ... 30.0 s / AUTO, 0.1 s step (Default = Auto)	Welding function that continues the shielding gas flow after the arc has extinguished. This ensures that the hot weld does not come into contact with air after the arc is extinguished, protecting the weld and also the electrode. Used for all metals. Especially stainless steel and titanium require longer post gas times.

Adjustable parameters in MicroTack welding:

Parameter	Value	Description
Pre gas	0.0 s ... 10.0 s, Auto, 0.1 s step (Default = Auto)	Welding function that starts the shielding gas flow before the arc ignites. This ensures that the metal does not come into contact with air at the start of the weld. Time value is preset by the user. Used for all metals, but especially for stainless steel, aluminum and titanium.
MicroTack spot time	1 ms ... 200 ms, step 1 ms (Default = 10 ms)	MicroTack welding: TIG welding function, which optimizes the spot welding characteristics. Used for tack welding of thin sheets or materials of different thicknesses. Allows fast and easy creation of clean tack welds with minimum heat input.
MicroTack pause time	50 ms ... 500 ms, step 1 ms (Default = 50 ms)	This is not visible in the settings if the MicroTack pulse count is only 1.
MicroTack spot count	1 ... 5 / endless, step 1 (Default = 1)	If Lift TIG is used, MicroTack graph shows only 1 spot and the spot count parameter is not visible.

Parameter	Value	Description
Post gas	0.1 s ... 30.0 s / AUTO, 0.1 s step (Default = Auto)	Welding function that continues the shielding gas flow after the arc has extinguished. This ensures that the hot weld does not come into contact with air after the arc is extinguished, protecting the weld and also the electrode. Used for all metals. Especially stainless steel and titanium require longer post gas times.

3.3.5 Pulse view

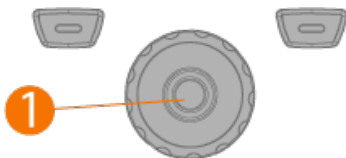
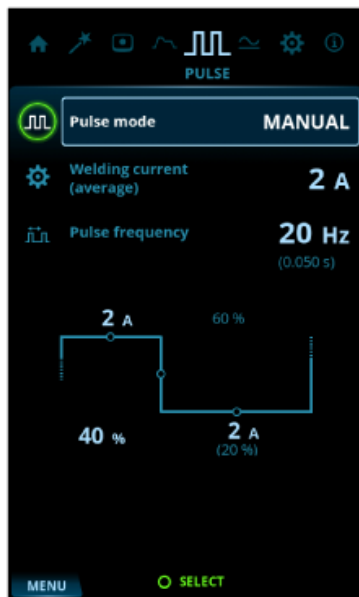

To adjust parameters:

1. Go to the **Pulse** view.
2. Turn the control knob (1) to browse through the parameters.
3. Select a parameter for adjustment by pressing the control knob button (1).
4. Adjust the parameter by turning the control knob (1).
5. Close the parameter setting by pressing the control knob button (1).

Adjustable parameters:

Parameter	Value	Description
Pulse mode	OFF / Auto / Manual / Double	When OFF is selected, pulse settings are not visible. When Auto is selected, pulse settings are visible but not adjustable. When Manual is selected, pulse settings are visible and adjustable.
Average current	Min = Current limit min, Max = Machine-specific	These values depend also on other pulse parameters. Maximum average current is also limited by the machine specifications.
Pulse frequency	0.2 Hz ... 300 Hz, 1 Hz step (Default = 1.0 Hz)	Determines how many pulse cycles are created per second (Hz). When AC current mode is used, the maximum Pulse frequency is 20 Hz.
Pulse ratio	10 % ... 70 %, 1 % step (Default = 40 %)	Determines how big part of the whole pulse cycle time is spent on pulse current.
Pulse base current	10 % ... 70 %, 1 % step (Default = 20 %)	The lower current level of the pulse cycle. In TIG welding, its main tasks are to cool down the weld pool and to maintain the arc.
Pulse current	10 A ... 300 A, 1 A step	These values depend also on other pulse parameters. Maximum pulse current is also limited by the machine specifications.



Adjusting one Pulse parameter value has an effect on the other values as well.

3.3.6 Current mode view



To adjust parameters:

1. Go to the **Current mode** view.
2. Turn the control knob (1) to browse through the parameters.
3. Select a parameter to be adjusted by pressing the control knob (1).
4. Adjust the parameter by turning the control knob (1).
5. Close the parameter setting by pressing the control knob (1).

Adjustable parameters:

Parameter	Value	Description
Current mode	DC- / DC+ / AC / MIX	<p>DC TIG: Direct current TIG welding process, where the polarity of the electrode is either positive or negative throughout the welding process. Negative polarity (DC-) allows high penetration, whereas positive polarity (DC+) is used only in special applications.</p> <p>AC TIG: Alternating current TIG welding process, where the polarity of the electrode alternates rapidly between positive and negative. Used especially in aluminum welding.</p> <p>MIX TIG: TIG welding function, where AC TIG and DC TIG processes alternate in pre-defined manner. Parameters are preset by the user according to welding application. Used especially for optimizing welding of aluminum materials of dissimilar thicknesses.</p>
AC Waveform	Sine / Optima / Square (Default: Optima)	<p>Function to change the wave form of the alternating current in AC TIG welding. Three options are available: sine, square and Optima. The wave form affects the shape of weld bead, penetration of the weld and the noise of the welding process. Select the one that suits the application.</p>
AC Frequency	30 Hz ... 250 Hz (Default = 60 Hz)	<p>Function to change the frequency of the alternating current in AC TIG welding. This setting adjusts the number of cycles per second. Used for changing the frequency of the welding current to best match the welder's preference and application.</p>
AC+ / AC- balance	Min/Max = -60 % ... 0 % (Default = -25%)	<p>Function to adjust the positive and negative current cycles in AC TIG welding. Low percentage means that, on average, the welding current is more on the negative side, and high percentage that, on average, the welding current is more on the positive side.</p>

Parameter	Value	Description
MIX TIG AC (time) ratio	Min/Max = 10 % ... 90 %, step 1 % (Default = 50 %)	MIX TIG: TIG welding function, where AC TIG and DC TIG processes alternate in pre-defined manner. Parameters are preset by the user according to welding application. Used especially for optimizing welding of aluminum materials of dissimilar thicknesses.
MIX TIG cycle time	Min/Max = 0.1 s ... 1.0 s, step 0.1 s (Default = 0.6 s)	
MIX TIG DC level	Min/Max = 50 % ... 150 %, step 1 % (Default = 100 %)	

3.3.7 Settings view

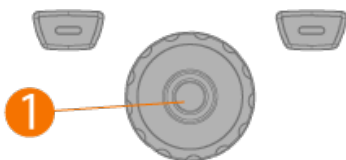

To adjust settings:

1. Go to the **Settings** view.
2. Turn the control knob (1) to browse through the settings groups and parameters.
3. Select a parameter to be adjusted or changed by pressing the control knob button (1).
4. Adjust or change the setting by turning the control knob (1).
5. Close the parameter setting by pressing the control knob button (1).

 Some of the settings are e.g. current mode and welding process specific and are visible or not visible in the settings menu accordingly.

Common welding settings:

Parameter	Value	Note
Welding process	TIG / MMA (Default = TIG)	Selecting a welding process changes automatically to the last active channel for the selected process.
Current limit min	TIG: 2 A / MMA: 8 A, step 1 A *	
Current limit max	TIG: power source's nominal value / MMA: power source's max. MMA current, step 1 A *	
Remote control mode	OFF / Remote / Torch (Default = OFF)	When a remote control or a torch remote control is selected, the welding current adjustment on the control panel is disabled.
Remote control min	Min = "Current limit min", Max = "Current limit max"	
Remote control max	Min = "Current limit min", Max = "Current limit max"	
Button remote channel control	OFF / ON (Default = OFF)	
Wireless remote	Pairing starts automatically when selected	New pairing information replaces the old information. Pairing status is shown as the settings value.

TIG settings:

Parameter	Value	Note
Balance limit min	-99 ... 0, step 1 (Default = -60)	
Balance limit max	0 ... +20, step 1 (Default = 0)	
Lift TIG current	5 A ... 40 A / Auto, step 1 A (Default = Auto = 10 A)	Contact current in the beginning of Lift TIG ignition.
HF spark force	50 % ... 110 %, step 1 % (Default = 100 %)	Adjusts the voltage of the high frequency spark used in ignition.
Positive ignition current	30 % ... 150 % / Auto, step 1 % (Default = Auto)	Adjusts the current level of the positive ignition sequence. Only in ACDC power sources (TIG).
Positive ignition time	0 ms ... 50 ms / Auto, step 10 ms (Default = Auto)	Adjusts the length of the positive ignition sequence. Only in ACDC power sources (TIG).
Negative ignition current	(ACDC): 100 % ... 300 % / Auto, Step 1 % (Default = Auto)	Adjusts the current level of the negative ignition sequence (TIG).
Ignition current	(DC): 100 % ... 300 % / Auto, step 1 % (Default = Auto)	
Negative ignition time	(ACDC): 0 ms ... 950 ms / Auto, step 10 ms (Default = Auto)	Adjusts the length of the negative ignition sequence (TIG).
Ignition time	(DC): 0 ms ... 950 ms / Auto, step 10 ms (Default = Auto)	

Parameter	Value	Note
Slight upslope	OFF / ON (Default = OFF)	This is a function that automatically creates a slight upslope to prevent electrode wearing caused by sudden current rises with high welding currents. This function has an effect only when the welding current is 100 A or more.
Startup level	5 % ... 40 %, step 1 % (Default = 10 %)	The point of welding current where the upslope begins.
Downslope cut level	5 % ... 40 %, step 1 % (Default = 10 %)	The point of welding current where the downslope ends.
2T downslope cut	OFF / ON (Default = OFF)	This is a function that allows the user to end the current downslope ramp with a quick press of the torch switch.
Nonlinear downslope	0 % ... 50 %, step 1 % (Default = 0 %)	Determines a point to which current goes down as fast as possible and then starts normal downslope.
Current freezing	OFF / ON (Default = OFF)	Welding current can be frozen to a certain level during downslope by pressing the trigger.
TIG antifreeze	OFF / ON (Default = OFF)	A function which automatically decreases the welding current significantly when electrode is touching the workpiece. Can be used for example to avoid unwanted dilution from electrode to welded metal.
AC phase swap current	5 A ... 20 A / Auto	Changes the welding current point where crossing the zero begins. Affects only AC TIG.

MMA settings:

Parameter	Value	Note
Welding current	Min/Max = Normal welding current limits	
Hot start	-10 ... +10, step 1 (Default = 0)	Welding function that uses higher welding current at the start of the weld. After the Hot start period the current drops to normal welding current level. The values for Hot start current level and its duration are preset manually. This facilitates the start of the weld especially with aluminum materials.
Arc force	-10 ... +10, step 1 (Default = 0)	Adjusts short circuit dynamics (roughness) of MMA welding by changing, for example, current levels.
MMA antifreeze	OFF / ON (Default = OFF)	A function which automatically decreases the welding current significantly when electrode is touching the workpiece. Can be used for avoiding MMA electrode getting too hot when it's in contact with the workpiece.

Parameter	Value	Note
VRD mode	OFF / ON (Default = OFF)	This setting can be locked so that the user cannot change it. In the equipment models where the VRD mode is locked permanently to ON (e.g. AU model), the VRD option is still visible in the settings, but it cannot be changed.

System settings:

Parameter	Value	Note
Gas test	Gas test time: 0 s ... 60 s, step 1 s (Default = 20 s)	Activating this starts the gas test with default time. Time can be changed by turning the control knob. Gas test can be stopped by pressing the control knob again.
Water cooler	OFF / Auto / ON (Default = Auto)	
Cooler flow watch	OFF / ON (Default = ON)	
Brightness	10 % ... 100 %, step 1 % (Default = 100 %)	
Weld data time	1 s ... 10 s, step 1 s (Default = 5 s)	
Show Weld Assist	ON / OFF (Default = ON)	A wizard-like utility for easy selection of welding parameters. The utility walks the user step-by-step through the selection of required parameters, presenting the selections in an easily understandable way for a non-technical user. Available in MTP35X control panel in MasterTig product family.
Screen saver	Default = Kemppti logo	An alternative screen saver image can be used. For more information, refer to "Screen saver" on page 61.
Screen saver time	OFF / 1 min ... 120 min, step 1 min (Default = 5 min)	
Date	Date setting (DD/MM/YYYY)	
Time (24h)	Time setting (HH:MM)	
Language	Language setting	
Factory reset...	Cancel / Start (Default = Cancel)	Settings item that activates the factory reset to restore factory settings on the device. Once the factory reset is complete, the power source must be restarted manually.

* Current range adjustable by welder in TIG welding:

- 2 A ... 130 A, 1 A step (MasterTig 235, limited supply mode)
- 2 A ... 235 A, 1 A step (MasterTig 235)
- 2 A ... 305 A, 1 A step (MasterTig 325, 335)
- 2 A ... 405 A, 1 A step (MasterTig 425)
- Default = Nominal value of the power source.

* Current range adjustable by welder in MMA welding:

- 8 A ... 85 A, 1 A step (MasterTig 235, limited supply mode)

- 8 A ... 185 A, 1 A step (MasterTig 235)
- 8 A ... 255 A, 1 A step (MasterTig 325, 335)
- 8 A ... 355 A, 1 A step (MasterTig 425)
- Default = MMA maximum current of the power source.

3.3.8 Info view

In the **Info** view you can see information about the equipment usage as well as software version for example.

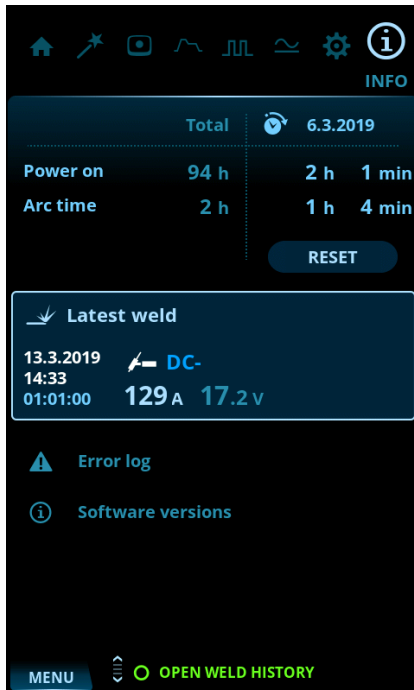

Included in the Info view:

- Usage counters
- Error status and error log
- Latest welds
- Power source type and model
- Power source and control panel software versions.

3.3.9 Screen saver

The screen saver image shown during start-up and when the control panel has been idle for a predefined time can be changed using the screen saver tool at kemp.cc/screensaver. To make the change, you'll need the image file you are planning to use and a USB memory stick.

Tools:

- Screwdriver, Torx head (T20).
1. On a web browser, go to kemp.cc/screensaver.
 2. Following the on-screen instructions, upload, edit and download the new screen saver image onto a USB memory stick.
 3. Detach the control panel from the power source:
 - >> Remove the top screw and panel cover.
 - >> First pull the top of the control panel slightly and then the rest of the panel.

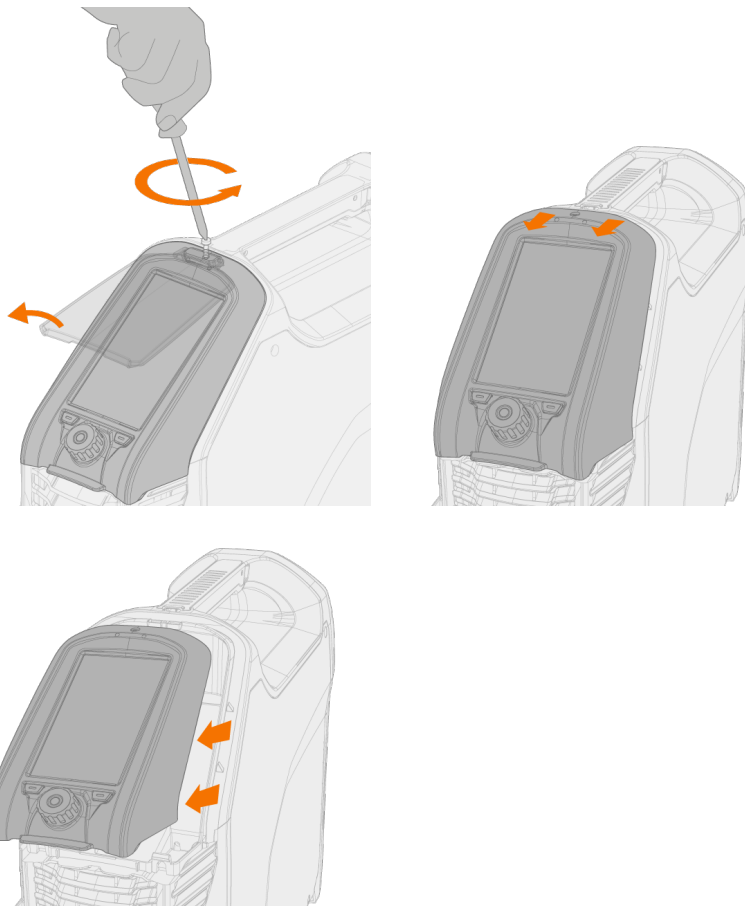

 Do not disconnect the control panel cable. The power source and control panel must be turned on.

4. Connect the USB memory stick to the USB connector on the rear side of the control panel. The control panel detects your USB memory stick automatically and shows a list of available images.

 Always connect and disconnect the USB device in a straight angle to avoid any additional stress to the USB connector.

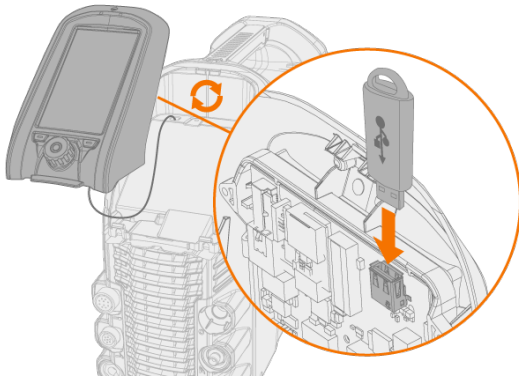

5. Following the on-screen instructions, and using the control panel controls, select the image on the USB memory stick you want to use as a screen saver.
6. Remove the USB memory stick and install the control panel back in place. Refer to "Installing control panel" on page 9 for more information.

 To delete a custom screen saver image from the control panel memory, or to use the Kemppi logo instead, go to "Settings view" on page 56.

3.4 Operating cooling unit

1. Ensure there is cooling liquid in the tank and that the welding torch is connected.
2. Press and briefly hold the cooling liquid circulation button on the cooling unit's front. This activates a pump motor which pumps the cooling liquid into the hoses and to the welding torch.

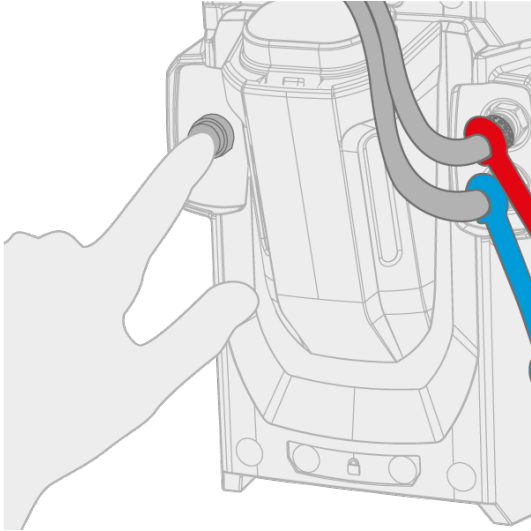

3. Observe the cooling system throughout the cooling liquid circulation process.

 *The cooling liquid circulation can be stopped at any time by pressing the cooling liquid circulation button again. If the system does not fill up during 1 minute after the button has been released, the automatic filling stops.*

3.5 Remote control

For installing remote control, refer to "Installing remote control" on page 19.

Hand remote control:

To adjust the welding current, turn the knob on the remote control.

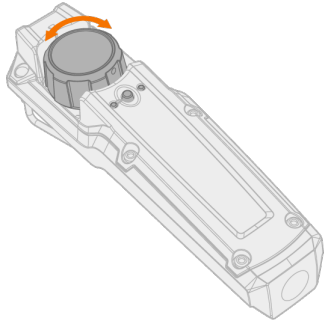

Tip: The remote control comes equipped with a handy clip for hanging the remote onto your belt.



Foot pedal remote control:

To adjust the welding current, press the pedal.

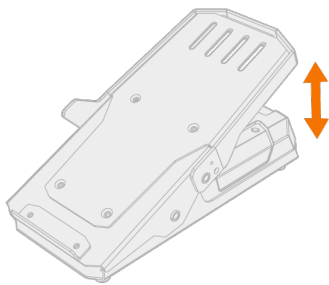



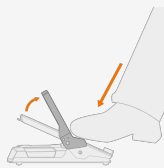

Tip: To shift the foot pedal position on the floor, use the foot pedal handle.



4. MAINTENANCE

When considering and planning routine maintenance, consider the operating frequency of the welding system and the working environment.

Correct operation of the welding machine and regular maintenance helps you avoid unnecessary downtime and equipment failure.

-  *Disconnect the power source from the mains before handling electrical cables.*
-  *If the welding equipment is left unused for a longer period, disconnect the mains plug from the mains.*
-  *Do not use the mains plug as a power ON/OFF switch.*
-  *Always check before use that interconnecting cable, shielding gas hose, earth return cable/clamp and mains cable are in serviceable condition. Ensure that the connectors are correctly fastened. Loose connectors can impair welding performance and damage connectors.*

Daily maintenance



Maintenance of power source

Follow these maintenance procedures to maintain the proper functioning of the welding system:

- Check that all covers and components are intact.
- Check all the cables and connectors. Do not use them if they are damaged.

For repairs, contact Kemppi at www.kemppi.com or your dealer.

Periodic maintenance

-  *Only an authorized electrician is allowed to carry out electrical work.*
-  *Only qualified service personnel is allowed to carry out periodic maintenance.*
-  *Before removing the cover plate, disconnect the power source from the mains and wait for about 2 minutes before discharging the capacitor.*

Check the electric connectors of the unit at least every six months. Clean oxidized parts and tighten loose connectors.

-  *Use the correct tension torque when fastening loose parts.*

Clean the outside parts of the unit from dust and dirt, for example, with a soft brush and vacuum cleaner. Also clean the ventilation grill at the back of the unit. Do not use compressed air, there is a risk that the dirt will compact even more tightly into gaps of cooling profiles.

-  *Do not use pressure washing devices.*

Service workshops

Kemppi Service Workshops complete the welding system maintenance according to the Kemppi service agreement.

The main aspects in the service workshop maintenance procedure are:

- Cleanup of the machine
- Maintenance of the welding tools
- Checkup of the connectors and switches
- Checkup of all electric connections
- Checkup of the power source mains cable and plug
- Repair of defective parts and replacement of defective components
- Maintenance test
- Test and calibration of operation and performance values when needed.

Find your closest service workshop at Kempfi website.

4.1 Disposal



Do not dispose of any electrical equipment with normal waste!

In observance of WEEE Directive 2012/19/EU on waste of electrical and electronic equipment and European Directive 2011/65/EU on the restriction of the use of certain hazardous substances in electrical and electronic equipment, and their implementation in accordance with national law, electrical equipment that has reached the end of its life must be collected separately and taken to an appropriate environmentally responsible recycling facility. The owner of the equipment is obliged to deliver a decommissioned unit to a regional collection center, as per the instructions of local authorities or a Kempfi representative. By applying these European Directives you improve the environment and human health.

5. TROUBLESHOOTING

 *The problems and the possible causes listed are not definitive, but suggest some typical situations that may turn up during normal use of the welding system. For further information and assistance, contact your nearest Kemppei service workshop.*

If you have received an error code, refer also to "Error codes" on page 70 .

General:

The welding system does not power up

- Check that the mains cable is plugged in properly.
- Check that the mains switch of the power source is at the ON position.
- Check that the mains power distribution is on.
- Check the mains fuse and/or the circuit breaker.
- Check that the earth return cable is connected.

The welding system stops working

- The torch may have overheated. Wait for it to cool down.
- Check that none of the cables is loose.
- The power source may have overheated. Wait for it to cool down and see that the cooling fans work properly and the air flow is unobstructed.

Welding torch:

The torch overheats

- Make sure the torch body is properly connected.
- Make sure that the welding parameters are within the range of the welding torch. If different torch components have separate limits for the maximum current; the lower one of these is the maximum current that can be used.
- Make sure the coolant circulation is working normally (see the coolant circulation warning LED on the power source).
- Measure the coolant circulation speed: detach the coolant output hose from the cooler unit when the power source is on, and let the coolant run into a measurement cup. The circulation must be at least 0.5 l/min.
- Make sure you are using original Kemppei consumable and spare parts. Incorrect spare part materials may also cause overheating.
- Make sure the connectors are clean, undamaged and properly fastened.

Weld quality:

Dirty and/or poor weld quality

- Check that the shielding gas has not run out.
- Check that the shielding gas flow is unobstructed.
- Check that the gas type is correct for the application.
- Check the polarity of the torch/electrode.
- Check that the welding procedure is correct for the application.
- Check that the filler material is correct type/diameter for the application and clean
- Check that the electrode is correct size/type and correctly shaped for the application
- Check that the base material is clean
- Check that the groove type is correct for the application.

Tip: For checking the correct welding settings, you can also use Weld Assist.

Varying welding performance

- Check that the welding torch is physically intact and the nozzle is clear of any obstructions.

- Check that the welding torch is not overheating.
- Check that the earth return clamp is properly attached to a clean surface of the workpiece.

5.1 Error codes

Error code	Error description	Possible reason	Proposed action
1	Power source not calibrated	Power source calibration has been lost.	Restart the power source. If problem persists, contact Kemppi service. Note: The equipment operation is limited when this error occurs.
2	Too low mains voltage	Voltage in mains network is too low.	Restart the power source. If problem persists, contact Kemppi service.
3	Too high mains voltage	Voltage in mains network is too high.	Restart the power source. If problem persists, contact Kemppi service.
4	Power source is overheated	Too long welding session with high power.	Do not shut down, let the fans cool the machine. If fans are not running, contact Kemppi service.
17	Phase is missing from mains supply	One or more phases are missing from the mains supply.	Check the mains cable and its connectors. Check the voltage of mains supply.
20	Power source cooling failure	Cooling capacity is reduced in the power source.	Clean the filters and clear any dirt from the cooling channel. Check that the cooling fans are running. If not, contact Kemppi service.
24	Cooling liquid overheated	Too long welding session with high power or high ambient temperature.	Do not turn off the cooler. Let the liquid circulate until the fans cool it down. If fans are not running, contact Kemppi service.
26	Cooling liquid not circulating	No cooling liquid or circulation is blocked.	Check the liquid level in the cooler. Check hoses and connectors for blockage.
27	Cooler not found	Cooling is turned on in the settings menu, but cooler is not connected to power source or cabling is faulty.	Check the cooler connections. Ensure that the cooling is turned off in the settings menu, if the cooler is not in use.
34	Unknown welding load	An unknown load connected to DIX connectors.	Remove any unintended resistive load connected to the welding equipment and restart the power source.
35	Too high mains current	Current drawn from the mains is too high.	Reduce welding power.
36	DC-link under-voltage	DC-link voltage is too low.	Check the mains voltage and/or the supply cable.
37	DC-link over-voltage	DC-link voltage is too high.	Check the mains voltage.
38	Mains voltage too high or too low	Mains voltage is too high or too low.	Check the mains voltage and/or the supply cable.
40	VRD error	Open circuit voltage exceeds the VRD limit.	Restart the power source. If problem persists, contact Kemppi service.
80	Torch cooling required	Water cooled torch is connected but the cooler is turned off.	Turn the cooler on in the settings menu or change the torch to an air cooled model.
81	Welding program data missing	Welding program data has been lost.	Restart the power source. If problem persists, contact Kemppi service.
244	Internal memory failure	Initialization failed.	Restart welding system. If problem persists, contact Kemppi service.

Error code	Error description	Possible reason	Proposed action
250	Internal memory failure	Memory communication failed.	Restart welding system. If problem persists, contact Kemppi service.

6. TECHNICAL DATA

"Power source MasterTig 235ACDC" on the next page

"Power source MasterTig 325DC" on page 75

"Power source MasterTig 335ACDC" on page 77

"Power source MasterTig 425DC" on page 79

"Cooling unit MasterTig Cooler M" on page 81

For ordering codes, see "Ordering codes" on page 92.

6.1 Power source MasterTig 235ACDC

MASTERTIG		235ACDC GM	235ACDC GM (VRD locked on)
Feature	Description	Value	
Mains connection cable		1~, 2,5 mm ²	1~, 2,5 mm ²
Mains connection voltage	1~ 50/60 Hz	110 / 220...240 V ±10 %	110 / 240 V ±10 %
Maximum supply current		27 A	25 A
Effective supply current		16 A	15 A
Fuse		16 A	15 A
No-load voltage (U_i)	MMA	50 V	23 V (locked to VRD)
No-load voltage (U_0)	MMA/TIG	91 V	91 V
No-load voltage (U_{rVRD})	MMA	23 V	23 V
Open circuit voltage (average)	MMA	50 V	23 V (locked to VRD)
Rated maximum output at 40 °C (240 V) (Duty cycle and process specified in the next column)	40 % TIG	230 A / 19.2 V	230 A / 19.2 V
	60 % TIG	200 A / 18 V	200 A / 18 V
	100 % TIG	170 A / 16.8 V	170 A / 16.8 V
	37 % MMA	180 A / 27.2 V	180 A / 27.2 V
	60 % MMA	150 A / 26 V	150 A / 26 V
	100 % MMA	120 A / 24.8 V	120 A / 24.8 V
Rated maximum output at 40 °C (110 V) (Duty cycle and process specified in the next column)	40 % TIG	130 A / 15.2 V	130 A / 15.2 V
	60 % TIG	120 A / 14.8 V	110 A / 14.4 V
	100 % TIG	90 A / 13.6 V	90 A / 13.6 V
	40 % MMA	85 A / 23.4 V	85 A / 23.4 V
	60 % MMA	75 A / 23.0 V	75 A / 23.0 V
	100 % MMA	55 A / 22.2 V	55 A / 22.2 V
Range of output (240 V)	TIG	3 A / 1 V ... 230 A / 31 V	3 A / 1 V ... 230 A / 31 V
	MMA	10 A / 10 V ... 180 A / 40 V	10 A / 10 V ... 180 A / 40 V
Range of output (110 V)	TIG	3 A / 1 V ... 130 A / 24 V	3 A / 1 V ... 130 A / 24 V
	MMA	10 A / 1 V ... 85 A / 35 V	10 A / 1 V ... 85 A / 35 V
Power factor, λ	230 V, MMA 180 A / 27.2 V	0,99	0,99
Efficiency, η	230 V, MMA 120 A / 24.8 V	84 %	84 %
Idle power	TIG	20 W	20 W
Operating temperature range		-20...+40 °C	-20...+40 °C
Storage temperature range		-20...+60 °C	-20...+60 °C
EMC class		A	A
Degree of protection		IP23S	IP23S

MASTERTIG		235ACDC GM	235ACDC GM (VRD locked on)
Feature	Description	Value	
External dimensions	LxWxH	544 x 205 x 443 mm	544 x 205 x 443 mm
Weight without accessories		19.1 kg	19.1 kg
Arc-on signal for relay		24 V / 50 mA	24 V / 50 mA
Voltage supply for cooling unit	U _{cu}	220...240 V (cooler not supported in 110 V)	240 V (cooler not supported in 110 V)
Recommended generator power (min)	S _{gen}	8 kVA	8 kVA
Wireless communication type: - Control panels MTP23X, MTP33X, MTP35X ⁽¹⁾ - Remote controls HR45, FR45 ⁽¹⁾	Transmitter frequency and power	2400-2483.5 MHz, 10 dBm	2400-2483.5 MHz, 10 dBm
Wired communication type	Remote	Analog	Analog
	CAN BUS	Kemppi Remote-Bus	Kemppi Remote-Bus
Arc striking voltage		5...11 kV	5...11 kV
Stick electrode diameters	ø mm	1.6...5.0 mm	1.6...5.0 mm
TIG welding cable connection type		R1/4	R1/4
Standards		IEC 60974-1,-3,-10 IEC 61000-3-12 GB 15579.1	IEC 60974-1,-3,-10 IEC 61000-3-12 AS 60974.1-2006 GB 15579.1

- 1)  *NO: These devices are not allowed to be used within a 20 km radius of the centre of Ny-Ålesund at Svalbard, Norway. This restriction applies to any 2-32 GHz transmitter operation.*

6.2 Power source MasterTig 325DC

MASTERTIG		325DC	325DC G	325DC GM
Feature	Description	Value		
Mains connection cable		3~, 2.5 mm ²	3~, 2.5 mm ²	3~, 2.5 mm ²
Mains connection voltage	3~ 50/60 Hz	380...460 V ±10 %	380...460 V ±10 %	220...230 V; 380...460 V ±10 %
Maximum supply current		14...13 A	15...11 A	25 A; 15...11 A
Effective supply current		11...10 A	11...8 A	17 A; 11...8 A
Fuse		16 A	16 A	20 A
No-load voltage (U_r)	MMA	50 V	50 V	50 V
No-load voltage (U_r) AU ⁽¹⁾	MMA	23 V	23 V	23 V
No-load voltage (U_0)	MMA/TIG	75...95 V	75...95 V	75...95 V
No-load voltage ($U_{r VRD}$)	MMA	23 V	23 V	23 V
Open circuit voltage (average)	MMA	50 V	50 V	50 V
Rated maximum output at 40 °C (Duty cycle and process specified in the next column)	40 % TIG	300 A / 22 V	300 A / 22 V	300 A / 22 V
	60 % TIG	230 A / 19.2 V	230 A / 19.2 V	230 A / 19.2 V
	100 % TIG	190 A / 17.6 V	190 A / 17.6 V	190 A / 17.6 V
	40 % MMA	250 A / 30 V	250 A / 30 V	250 A / 30 V
	60 % MMA	230 A / 29.2 V	230 A / 29.2 V	230 A / 29.2 V
	100 % MMA	190 A / 27.6 V	190 A / 27.6 V	190 A / 27.6 V
Range of output	TIG	3 A / 1 V ... 300 A / 38 V	3 A / 1 V ... 300 A / 38 V	3 A / 1 V ... 300 A / 27 V (@ 220 V)
	MMA	10 A / 10 V ... 250 A / 39 V	10 A / 10 V ... 250 A / 39 V	10 A / 10 V ... 250 A / 32 V (@ 220 V)
Power factor, λ	400 V, MMA 250 A / 30 V	0.93	0.90	0.85
Efficiency, η	400 V, MMA 190 A / 27.6 V	89 %	89 %	88 %
Idle power	TIG	20 W	20 W	20 W
Operating temperature range		-20...+40 °C	-20...+40 °C	-20...+40 °C
Storage temperature range		-20...+60 °C	-20...+60 °C	-20...+60 °C
EMC class		A	A	A
Min. short-circuit power of supply network	S_{sc}	1.7 MVA	1.9 MVA	1.4 MVA
Degree of protection		IP23S	IP23S	IP23S
External dimensions	LxWxH	544 x 205 x 443 mm	544 x 205 x 443 mm	544 x 205 x 443 mm
Weight without accessories		21.0 kg	21.5 kg	21.5 kg
Arc-on signal for relay		24 V / 50 mA	24 V / 50 mA	24 V / 50 mA
Voltage supply for cooling unit	U_{cu}	380...460 V	380...460 V	220...460 V

MASTERTIG		325DC	325DC G	325DC GM
Feature	Description	Value		
Recommended generator power (min)	S _{gen}	20 kVA	20 kVA	20 kVA
Wireless communication type: - Control panels MTP23X, MTP33X, MTP35X ⁽²⁾ - Remote controls HR45, FR45 ⁽²⁾	Transmitter frequency and power	2400-2483,5 MHz, 10 dBm	2400-2483,5 MHz, 10 dBm	2400-2483,5 MHz, 10 dBm
Wired communication type	Remote	Analog	Analog	Analog
	CAN BUS	Kemppi Remote-Bus	Kemppi Remote-Bus	Kemppi Remote-Bus
Arc striking voltage		5...11 kV	5...11 kV	5...11 kV
Stick electrode diameters	∅ mm	1.6...6.0 mm	1.6...6.0 mm	1.6...6.0 mm
TIG welding cable connection type		R1/4	R1/4	R1/4
Standards		IEC 60974-1,-3,-10 IEC 61000-3-12 AS 60974.1-2006 ⁽³⁾ GB 15579.1	IEC 60974-1,-3,-10 IEC 61000-3-12 AS 60974.1-2006 ⁽³⁾ GB 15579.1	IEC 60974-1,-3,-10 IEC 61000-3-12 AS 60974.1-2006 ⁽³⁾ GB 15579.1

¹⁾ In AU power source models with the Voltage Reduction Device (VRD) function locked on, only this value is applicable.

²⁾  **NO:** These devices are not allowed to be used within a 20 km radius of the centre of Ny-Ålesund at Svalbard, Norway. This restriction applies to any 2-32 GHz transmitter operation.

³⁾ Applies only to the power source model versions where the VRD function is locked on.

6.3 Power source MasterTig 335ACDC

MASTERTIG		335ACDC	335ACDC G	335ACDC GM
Feature	Description	Value		
Mains connection cable		3~, 2.5 mm ²	3~, 2.5 mm ²	3~, 2.5 mm ²
Mains connection voltage	3~ 50/60 Hz	380...460 V ±10 %	380...460 V ±10 %	220...230 V; 380...460 V ±10 %
Maximum supply current		15...13 A	16...12 A	25 A; 16...12 A
Effective supply current		11...10 A	11...8 A	17 A; 11...8 A
Fuse		16 A	16 A	20 A
No-load voltage (U_r)	MMA	50 V	50 V	50 V
No-load voltage (U_r) AU ⁽¹⁾	MMA	23 V	23 V	23 V
No-load voltage (U_0)	MMA/TIG	75 ... 95 V	75 ... 95 V	75 ... 95 V
No-load voltage ($U_{r VRD}$)	MMA	23 V	23 V	23 V
Open circuit voltage (average)	MMA	50 V	50 V	50 V
Rated maximum output at 40 °C (Duty cycle and process specified in the next column)	40 % TIG	300 A / 22 V	300 A / 22 V	300 A / 22 V
	60 % TIG	230 A / 19.2 V	230 A / 19.2 V	230 A / 19.2 V
	100 % TIG	190 A / 17.6 V	190 A / 17.6 V	190 A / 17.6 V
	40 % MMA	250 A / 30 V	250 A / 30 V	250 A / 30 V
	60 % MMA	230 A / 29.2 V	230 A / 29.2 V	230 A / 29.2 V
	100 % MMA	190 A / 27.6 V	190 A / 27.6 V	190 A / 27.6 V
Range of output	TIG	3 A / 1 V ... 300 A / 38 V	3 A / 1 V ... 300 A / 38 V	3 A / 1 V ... 300 A / 27 V (@ 220 V)
	MMA	10 A / 10 V ... 250 A / 39 V	10 A / 10 V ... 250 A / 39 V	10 A / 10 V ... 250 A / 32 V (@ 220 V)
Power factor, λ	400 V, MMA 250 A / 30 V	0.93	0.90	0.89
Efficiency, η	400 V, MMA 190 A / 27.6 V	86 %	86 %	86 %
Idle power	TIG	20 W	20 W	20 W
Operating temperature range		-20...+40 °C	-20...+40 °C	-20...+40 °C
Storage temperature range		-20...+60 °C	-20...+60 °C	-20...+60 °C
EMC class		A	A	A
Min. short-circuit power of supply network	S_{sc}	1.7 MVA	1.9 MVA	1.4 MVA
Degree of protection		IP23S	IP23S	IP23S
External dimensions	LxWxH	544 x 205 x 443 mm	544 x 205 x 443 mm	544 x 205 x 443 mm
Weight without accessories		22.0 kg	22.5 kg	22.5 kg
Arc-on signal for relay		24 V / 50 mA	24 V / 50 mA	24 V / 50 mA
Voltage supply for cooling unit	U_{cu}	380...460 V	380...460 V	220...460 V

MASTERTIG		335ACDC	335ACDC G	335ACDC GM
Feature	Description	Value		
Recommended generator power (min)	S_{gen}	20 kVA	20 kVA	20 kVA
Wireless communication type: - Control panels MTP23X, MTP33X, MTP35X ⁽²⁾ - Remote controls HR45, FR45 ⁽²⁾	Transmitter frequency and power	2400-2483.5 MHz, 10 dBm	2400-2483.5 MHz, 10 dBm	2400-2483.5 MHz, 10 dBm
Wired communication type	Remote	Analog	Analog	Analog
	CAN BUS	Kemppi Remote-Bus	Kemppi Remote-Bus	Kemppi Remote-Bus
Arc striking voltage		5...11 kV	5...11 kV	5...11 kV
Stick electrode diameters	∅ mm	1.6...6.0 mm	1.6...6.0 mm	1.6...6.0 mm
TIG welding cable connection type		R1/4	R1/4	R1/4
Standards		IEC60974-1,-3,-10 IEC 61000-3-12 AS 60974.1-2006 ⁽³⁾ GB 15579.1	IEC60974-1,-3,-10 IEC 61000-3-12 AS 60974.1-2006 ⁽³⁾ GB 15579.1	IEC60974-1,-3,-10 IEC 61000-3-12 AS 60974.1-2006 ⁽³⁾ GB 15579.1

¹⁾ In AU power source models with the Voltage Reduction Device (VRD) function locked on, only this value is applicable.

²⁾  *NO: These devices are not allowed to be used within a 20 km radius of the centre of Ny-Ålesund at Svalbard, Norway. This restriction applies to any 2-32 GHz transmitter operation.*

³⁾ Applies only to the power source model versions where the VRD function is locked on.

6.4 Power source MasterTig 425DC

MASTERTIG		425DC G
Feature	Description	Value
Mains connection cable		3~, 2.5 mm ²
Mains connection voltage	3~ 50/60 Hz	380...460 V ±10 %
Maximum supply current		23 ... 18 A
Effective supply current		16 ... 14 A
Fuse		16 A
No-load voltage (U_l)	MMA	50 V
No-load voltage (U_l) AU ⁽¹⁾	MMA	23 V
No-load voltage (U_0)	MMA/TIG	70 ... 95 V
No-load voltage ($U_{r VRD}$)	MMA	23 V
Open circuit voltage (average)	MMA	50 V
Rated maximum output at 40 °C (Duty cycle and process specified in the next column)	30 % TIG	400 A / 26 V
	60 % TIG	320 A / 22.8 V
	100 % TIG	280 A / 21.2 V
	40 % MMA	350 A / 34 V
	60 % MMA	320 A / 32.8 V
	100 % MMA	270 A / 30.8 V
Range of output	TIG	3 A / 1 V ... 400 A / 41 V
	MMA	10 A / 10 V ... 350 A / 42 V
Power factor, λ	400 V, MMA 350 A / 34 V	0.91
Efficiency, η	400 V, MMA 280 A / 31.2 V	89%
Idle power	TIG	16 W
Operating temperature range		-20...+40 °C
Storage temperature range		-20...+60 °C
EMC class		A
Min. short-circuit power of supply network	S_{sc}	2.0 MVA
Degree of protection		IP23S
External dimensions	LxWxH	544 x 205 x 443 mm
Weight without accessories		23.6 kg
Arc-on signal for relay		24 V / 50 mA
Voltage supply for cooling unit	U_{cu}	380...460 V
Recommended generator power (min)	S_{gen}	20 kVA
Wireless communication type: - Control panels MTP23X, MTP33X, MTP35X ⁽²⁾ - Remote controls HR45, FR45 ⁽²⁾	Transmitter frequency and power	2400-2483.5 MHz, 10 dBm

MASTERTIG		425DC G
Feature	Description	Value
Wired communication type	Remote	Analog
	CAN BUS	Kemppi Remote-Bus
Arc striking voltage		5...11 kV
Stick electrode diameters	∅ mm	1.6...7.0 mm
TIG welding cable connection type		R1/4
Standards		IEC60974-1,-3,-10 IEC 61000-3-12 AS 60974.1-2006 ⁽³⁾ GB 15579.1

¹⁾ In AU power source models with the Voltage Reduction Device (VRD) function locked on, only this value is applicable.

²⁾  *NO: These devices are not allowed to be used within a 20 km radius of the centre of Ny-Ålesund at Svalbard, Norway. This restriction applies to any 2-32 GHz transmitter operation.*

³⁾ Applies only to the power source model versions where the VRD function is locked on.

6.5 Cooling unit MasterTig Cooler M

MASTERTIG COOLER M		
Feature	Description	Value
Connection voltage	U ₁ 50/60 Hz	220...460 V AC, 1~/3~
Maximum rated supply current	I _{1max}	1.0 A
Rated cooling power at 1 l/min		0.9 kW
Cooling power at 1.6 l/min		1.0 kW
Recommended coolant		MPG 4456 (Kemppi mixture)
Coolant pressure (max)		0.4 MPa
Tank volume		3.0 l
Operating temperature range *		-20 ... +40 °C
Storage temperature range		-20 ... +60 °C
EMC class		A
Degree of protection **		IP23S
External dimensions	L x W x H	615 x 206 x 268 mm
Weight without accessories		12.5 kg
Standards		IEC 60974-2 IEC 60974-10

* With recommended coolant

** When mounted

6.6 TIG guide tables

i The tables in this chapter are given only as a general guidance. The information provided is based solely on the use of WC20 (grey) electrode and Argon gas.

TIG welding (AC)

Welding current range AC		Electrode (WC20)	Gas nozzle		Gas flow rate
Min. A	Max. A	ø mm	number	ø mm	l/min (Argon)
15	90	1.6	4 / 5 / 6	6.5 / 8.0 / 9.5	6...7
20	150	2.4	6 / 7	9.5 / 11.0	7...8
30	200	3.2	7 / 8 / 10	11.0 / 12.5 / 16	8...10
40	350	4.0	10 / 11	16 / 17.5	10...12

TIG welding (DC)

Welding current range DC		Electrode (WC20)	Gas nozzle		Gas flow rate
Min. A	Max. A	ø mm	number	ø mm	l/min (Argon)
5	80	1.0	4 / 5	6.5 / 8.0	5...6
70	140	1.6	4 / 5 / 6	6.5 / 8.0 / 9.5	6...7
140	230	2.4	6 / 7	9.5 / 11.0	7...8
225	330	3.2	7 / 8 / 10	11.0 / 12.5 / 16	8...10

6.7 Welding processes and features

MasterTig 235, 325, 335 and 425

2

2T downslope cut

This is a function that allows the user to end the current downslope ramp with a quick press of the torch switch.

A

AC Balance

Function to adjust the positive and negative current cycles in AC TIG welding. Low percentage means that, on average, the welding current is more on the negative side, and high percentage that, on average, the welding current is more on the positive side.

AC Frequency

Function to change the frequency of the alternating current in AC TIG welding. This setting adjusts the number of cycles per second. Used for changing the frequency of the welding current to best match the welder's preference and application.

AC phase swap current

Changes the welding current point where crossing the zero begins. Affects only AC TIG.

AC TIG

Alternating current TIG welding process, where the polarity of the electrode alternates rapidly between positive and negative. Used especially in aluminum welding.

AC Waveform

Function to change the wave form of the alternating current in AC TIG welding. Three options are available: sine, square and Optima. The wave form affects the shape of weld bead, penetration of the weld and the noise of the welding process. Select the one that suits the application.

Arc break

Determines the point where the arc is extinguished in relation to the arc length in MMA welding. The purpose is to optimize the welding termination for each electrode type to prevent the arc from being accidentally extinguished during welding and to avoid burn marks to the weld piece when the welding is stopped.

Arc force

Adjusts short circuit dynamics (roughness) of MMA welding by changing, for example, current levels.

Arc time

Tells how long the welding arc has been on.

Auto pulse

TIG welding process, where the welding current alternates between two current levels: base current and pulse current. Only welding current needs to be adjusted and pulse parameters are preset automatically. Used for optimizing the arc characteristics for desired welding applications.

B**Balance maximum**

Sets the maximum value for AC balance setting.

Balance minimum

Sets the minimum value for AC balance setting.

Base current

The lower current level of the pulse cycle. In TIG welding, its main tasks are to cool down the weld pool and to maintain the arc.

C**Continuous welding**

Normal TIG welding which doesn't have any pause times.

Current freezing

Welding current can be frozen to a certain level during downslope by pressing the trigger.

D**DC TIG**

Direct current TIG welding process, where the polarity of the electrode is either positive or negative throughout the welding process. Negative polarity (DC-) allows high penetration, whereas positive polarity (DC+) is used only in special applications.

Double pulse

Double pulse TIG welding can be used for example to increase travel speed or to produce welds with high visual requirements. The welding current is pulsed in two different frequencies: slow and fast. The fast frequency makes the arc more focused, and the slow frequency produces a nice fish-scale appearance to welds.

Downslope

Welding function that determines the time, during which the welding current gradually decreases to the end current level. The value for the downslope time is preset by the user. The value zero means the function is off.

Downslope cut level

The point of welding current where the downslope ends.

H**HF ignition**

Ignition mode in TIG welding. In HF ignition, a press on the torch trigger produces a high voltage pulse that creates a spark to ignite the arc. The HF ignition mode must be activated in the control panel.

HF spark force

Adjusts the voltage of the high frequency spark used in ignition.

Hot start

Welding function that uses higher welding current at the start of the weld. After the Hot start period the current drops to normal welding current level. The values for Hot start current level and its duration are preset manually. This facilitates the start of the weld especially with aluminum materials.

I**Ignition current**

Adjusts the current level of the negative ignition sequence (TIG).

Ignition mode

The way in which the welding arc is ignited. In TIG welding, two ignition modes are available: High Frequency (HF) ignition and Lift TIG ignition. The HF ignition uses a voltage pulse to initiate the arc, and the Lift TIG ignition needs a physical contact between the electrode and the work piece.

L**Lift TIG current**

Contact current in the beginning of Lift TIG ignition.

Lift TIG ignition

Ignition mode in TIG welding. In Lift TIG ignition you briefly touch the work piece with the electrode, then press the trigger and lift the electrode to a small distance from the work piece. The Lift TIG ignition must be activated in the control panel. Also known as "Touch ignition" or "Contact ignition".

M**Manual pulse**

TIG welding process, where the welding current alternates between two current levels: base current and pulse current. Parameters are preset by the user. Used for optimizing the arc characteristics for desired welding applications.

Memory channel

Place to store predefined welding parameter settings. A welding machine can include a number of preset channels. Users can create new channels for their own welding jobs and modify or delete them. Makes parameter selection easier, and in some cases allows transferring settings from one welding machine to another.

MicroTack

TIG welding function, which optimizes the spot welding characteristics. Used for tack welding of thin sheets or materials of different thicknesses. Allows fast and easy creation of clean tack welds with minimum heat input.

Minilog

TIG welding function, which allows using the torch switch to change between the welding current and Mini-log current. Parameters are preset by the user. Welding over tack welds is one application, and it also functions as a "pause current" when the welding position changes for example.

MIX TIG

TIG welding function, where AC TIG and DC TIG processes alternate in predefined manner. Parameters are preset by the user according to welding application. Used especially for optimizing welding of aluminum materials of dissimilar thicknesses.

MMA

Manual arc welding process that uses a consumable electrode. The electrode is covered with flux material that protects the weld area from oxidation and contamination.

MMA antifreeze

A function which automatically decreases the welding current significantly when electrode is touching the workpiece. Can be used for avoiding MMA electrode getting too hot when it's in contact with the workpiece.

N**Negative ignition**

The sequence of TIG ignition which is on the negative side of the current. It is typically the last part of the ignition with ACDC power sources. With DC power sources, it's the only part of the ignition with TIG.

Negative ignition current

Adjusts the current level of the negative ignition sequence (TIG).

Negative ignition time

Adjusts the length of the negative ignition sequence (TIG).

Non-linear downslope

Determines a point to which current goes down as fast as possible and then starts normal downslope.

P**Positive ignition**

The sequence of TIG ignition which is on the positive side of the current. It is typically the first part of the ignition with ACDC power sources. DC power sources don't have positive ignition with TIG.

Positive ignition current

Adjusts the current level of the positive ignition sequence. Only in ACDC power sources (TIG).

Positive ignition time

Adjusts the length of the positive ignition sequence. Only in ACDC power sources (TIG).

Post gas

Welding function that continues the shielding gas flow after the arc has extinguished. This ensures that the hot weld does not come into contact with air after the arc is extinguished, protecting the weld and also the electrode. Used for all metals. Especially stainless steel and titanium require longer post gas times.

Pre gas

Welding function that starts the shielding gas flow before the arc ignites. This ensures that the metal does not come into contact with air at the start of the weld. Time value is preset by the user. Used for all metals, but especially for stainless steel, aluminum and titanium.

Pulse current

The higher current level of the pulse cycle. In TIG welding, its main task is to create weld pool or increase the heat of the weld pool.

Pulse frequency

Determines how many pulse cycles is created per second (Hz).

Pulse ratio

Determines how big part of the whole pulse cycle time is spent on pulse current.

Pulse TIG

TIG welding process, where the welding current changes between two current levels: base current and pulse current. Parameters can be set either manually or automatically. Used for optimizing the arc characteristics for desired welding applications.

S**Search arc**

Welding function that allows using a brief low current period at the start of the weld. This enables precise start of welding. The parameters are preset by the user.

Slight upslope

This is a function that automatically creates a slight upslope to prevent electrode wearing caused by sudden current rises with high welding currents. This function has an effect only when the welding current is 100 A or more.

Soft start

Welding function that uses lower welding current at the start of the weld. After the Soft start period the current rises to normal welding current level. The values for Soft start current level and its duration are preset manually. Soft start is used to soften the start period of welding especially with steels.

Spot welding

TIG welding function, which automatically produces a weld of predefined duration. Parameters are preset by the user. This function is used for attaching two pieces of materials with tack welds, for example joining thin sheets with low heat input.

Startup level

The point of welding current where the upslope begins.

T**Tail arc**

Welding function that allows using a brief low current period at the end of the weld. This reduces welding defects caused by end cratering. The parameters are preset by the user. The value zero means the function is off.

TIG

Manual welding process that typically uses a non-consumable tungsten electrode, a separate filler material, and an inert shielding gas to protect the weld area from oxidation and contamination during the welding process. The use of a filler material is not always mandatory in TIG welding.

TIG antifreeze

A function which automatically decreases the welding current significantly when electrode is touching the workpiece. Can be used for example to avoid unwanted dilution from electrode to welded metal.

Trigger logic

Welding torches have two alternative operation modes: 2T and 4T. They differ in the way how the trigger operates. In 2T mode you hold the trigger down while welding, whereas in 4T mode you press and release the trigger to start or to stop welding and to use special trigger functions, such as Minilog.

Trigger logic 2T

Trigger operation mode of a welding torch. When you press the trigger down in 2T mode, the shielding gas starts to flow and the arc ignites. Hold down the trigger while welding and release it when you want to stop

welding.

Trigger logic 4T

Trigger operation mode of a welding torch. When you press the trigger down in 4T mode, shielding gas starts to flow but the arc won't ignite until you release the trigger. To stop welding you press the trigger down again and then release it to extinguish the arc.

U**Upslope**

Welding function that determines the time, during which the welding current gradually increases to desired welding current level at the start of the weld. The value for the upslope time is preset by the user. The value zero means the function is off.

















V**VRD (voltage reduction device)**















A safety device used in welding equipment to reduce the open-circuit voltage to maintain below a certain voltage value. This reduces the risk of electric shock particularly in dangerous environments, such as closed or damp spaces. VRD may also be required by law in certain countries or regions.







W**Weld Assist**

A wizard-like utility for easy selection of welding parameters. The utility walks the user step-by-step through the selection of required parameters, presenting the selections in an easily understandable way for a non-technical user. Available in MTP35X control panel in MasterTig product family.







6.8 Symbols used

Symbol	Description
	Coolant output
	Gas input
	Gas output
	DPulse (Double pulse)
	Carbon arc gouging
	TIG
	TIG HF ignition
	TIG Contact ignition
	TIG Water Cooling
	TIG Gas Cooling
	MIG
	MMA
	Arc break
	Pulse
	Soft Start
	Hot Start

	Upslope
	Crater Fill with Downslope
	Crater Fill with Downlevel
	Tail arc
	Minilog
2T	2T
4T	4T
4T LOG	4T LOG
	4T LOG + Minilog
	MicroTack welding
	Continuous welding
	Spot welding
	Gas test
	Frequency or Wavelength
	Base current
	Pulse current
	AC Frequency
	AC Sine

	AC Square
	AC Optima
	Remote control
	Remote control in TIG torch
	Foot pedal
	High voltage
	Low voltage

Common symbols used in Kemppi documentation:

Symbol	Description
	User manual
	CE mark
	EMC Class A
	Electrical and electronic waste
	High voltage (warning)
	Protective earth

7. ORDERING CODES

Equipment	Description	Ordering code
MasterTig 235ACDC GM	Power source: 230 A AC/DC, generator and multi-voltage use	MT235ACDCGM
	Power source: 230A AC/DC, generator and multi-voltage use, VRD locked on	MT235ACDCGMAU
MasterTig 325DC	Power source: 300 A DC	MT325DC
MasterTig 325DC G	Power source: 300 A DC, generator use	MT325DCG
	Power source: 300 A DC, generator use, VRD locked on	MT325DCGAU
MasterTig 325DC GM	Power source: 300 A DC, generator and multi-voltage use	MT325DCGM
MasterTig 335ACDC	Power source: 300 A AC/DC	MT335ACDC
MasterTig 335ACDC G	Power source: 300 A AC/DC, generator use	MT335ACDCG
	Power source: 300 A AC/DC, generator use, VRD locked on	MT335ACDCGAU
MasterTig 335ACDC GM	Power source: 300 A AC/DC, generator and multi-voltage use	MT335ACDCGM
MasterTig 425DC G	Power source: 400 A DC, generator use	MT425DCG
	Power source: 400 A DC, generator use, VRD locked on	MT425DCGAU
MasterTig Cooler M	Cooling unit, multi-voltage use	MTC1KWM
MTP23X	Control panel: Membrane panel, DC	MTP23X
MTP33X	Control panel: Membrane panel, AC/DC	MTP33X
MTP35X	Control panel: 7" TFT panel, DC, AC/DC	MTP35X
HR43	Wired remote	HR43
HR45	Wireless remote	HR45
FR43	Wired foot pedal remote	FR43
FR45	Wireless foot pedal remote	FR45
P43MT	Transport unit, 4 wheel undercarriage	P43MT
T25MT	Transport unit, 2 wheel cart	T25MT
P45MT	Transport unit, 4 wheel cart	P45MT
-	Particle filter pack	SP020952

* VRD (Voltage Reduction Device).

7.1 Accessories

Tip: Letters with the product model names stand for:

W = water-cooled, G = gas-cooled, F = flexible neck, S = S neck, N = no switch (no remote option).

Flexlite TX			
Product	Ordering code		
	4 m:	8 m:	16 m:
Flexlite TX 135GF	TX135GF4	TX135GF8	TX135GF16
Flexlite TX 165GF	TX165GF4	TX165GF8	TX165GF16
Flexlite TX 165GS	TX165GS4	TX165GS8	TX165GS16
Flexlite TX 165G	TX165G4	TX165G8	TX165G16
Flexlite TX 225G	TX225G4	TX225G8	TX225G16
Flexlite TX 225GS	TX225GS4	TX225GS8	TX225GS16
Flexlite TX 305WF	TX305WF4	TX305WF8	TX305WF16
Flexlite TX 255WS	TX255WS4	TX255WS8	TX255WS16
Flexlite TX 355W	TX355W4	TX355W8	TX355W16
Flexlite TX 135GFN	TX135GFN4	TX135GFN8	-
Flexlite TX 165GFN	TX165GFN4	TX165GFN8	-
Flexlite TX 165GSN	-	TX165GSN8	-
Flexlite TX 225GN	TX225GN4	TX225GN8	-
Flexlite TX 255WSN	-	TX255WSN8	-
Flexlite TX 305WFN	-	TX305WFN8	-
Flexlite TX 355WN	-	TX355WN8	-

External package dimensions, mm (L x W x H): 590 x 390 x 130 / 80.

Flexlite TX remotes (optional)		
Product	Ordering code	
	For water-cooled torch:	For gas-cooled torch:
Flexlite TXR10 remote, roller switch	TXR10W	TXR10G
Flexlite TXR20 remote, rocker switch	TXR20W	TXR20G

Flexlite TX other accessories (optional)	
Product	Ordering code
Flexlite TX trigger extension	SP014802