

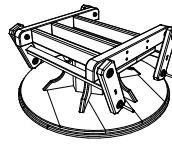

- 1 - (A) Swivel Base
- 1 - (B) Seat
- 1 - (C) Back
- 2 - (D) Armrest's
- 2 - (E) Lintels

Tools Required

- 5/32 Hex Key (Included)
- #2 Square Drive Bit (Not Included)
- 9/16" Wrench (Not Included)



(A)

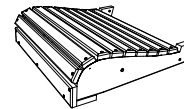

(B)



(C)

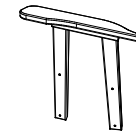

(D)

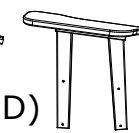

(E)



- Hardware**
- 2 - 3 1/2" Stainless Wafer Bolts
 - 2 - 2 1/2" Stainless Wafer Bolts
 - 4 - 2" Stainless Wafer Bolts
 - 4 - 3/8" Nuts
 - 4 - Washers
 - 8 - 2" Screws
 - 1 - 5/32 Hex Key



1. Attach (D) Armrest Assemblies to (A) Swivel Base using 2 Nuts & 2 Washers per side, Be sure to match all numbers & or letters.

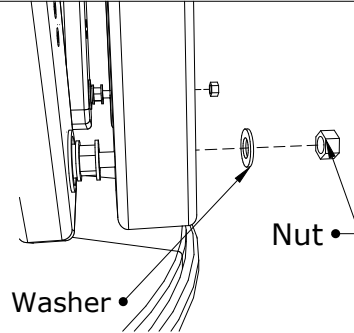
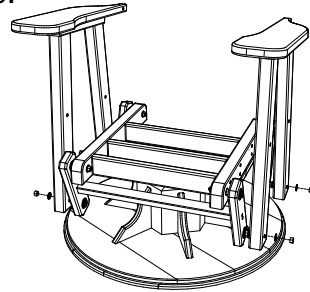

2. Attach (C) Back to (B) Seat using 1 - 2" Wafer Bolt per side, Be sure to match all numbers & or letters, tighten Bolts with included Hex Key.

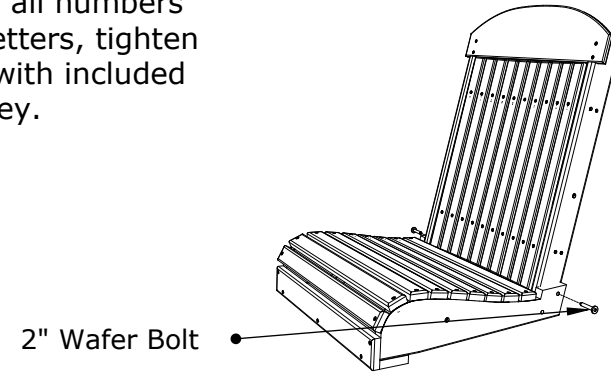

3. Slide Seat & Back between Armrests & attach to Armrests using 1 - 3 1/2" Wafer Bolt 1 - 2 1/2" Wafer Bolt & 1 - 2" Wafer Bolt per side, be sure to match all numbers & or letters, tighten Bolts with included Hex Key.

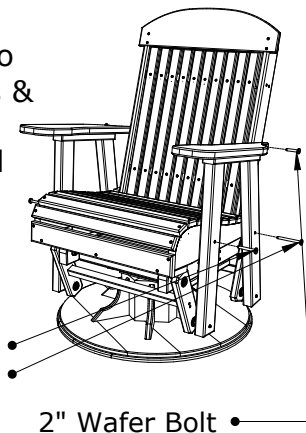

- 2 1/2" Wafer Bolt
- 3 1/2" Wafer Bolt

2" Wafer Bolt

4. Attach (E) Lintels to Armrest assemblies using 4 - 2" Screws per side, be sure to match all numbers & or letters.

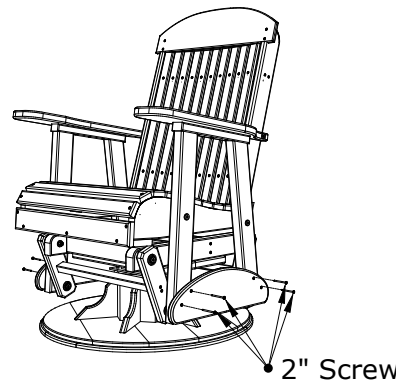

2" Screw



2' Classic Swivel Glider Assembly Instructions

08/2/ 2019

R.M.