

JIBE LIGHTING—HEADQUARTERS  
Hogebrinkerweg 14V – 3871 KN Hoevelaken  
Netherlands Tel: +31 (0)33 844 7111  
info@jibe.lighting – www.jibe.lighting

JIBE LIGHTING—DE  
Marie-Curie Ring 38 – D-63477 Germany  
Tel: +49 (0)618 1299 72 81  
info@jibe.lighting –www.jibe.lighting

JIBE LIGHTING—NORTH-AMERICA  
5917 NW 63 Way – Parkland, FL 33067 USA Tel:  
954-899-4040  
info@jibe.lighting – www.jibe.lighting

# LED LIGHTING SERIES 2020



LED THERE BE LIGHT

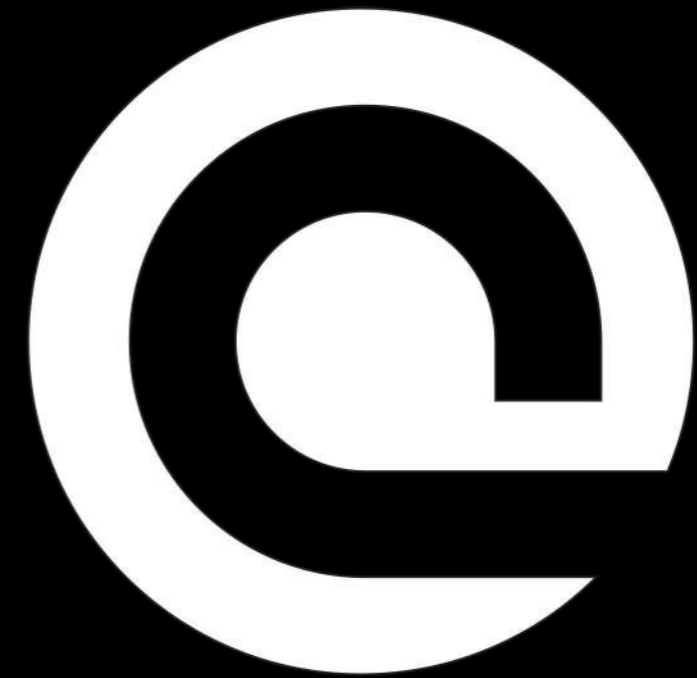

# جيبايز

© 2020 Jibe Lighting - all rights reserved  
Jibe reserves the right to alter material, dimensions and characteristics without prior notice.  
Read installation instructions carefully. Technical information on the installation instruction has precedence over the information in the brochure.  
Our general terms and conditions shall apply notwithstanding any stipulation to the contrary to all the orders and agreements with Jibe.  
You can obtain a copy of these conditions on demand.  
For latest information and specifications of the full product range visit [www.jibe.lighting](http://www.jibe.lighting)

# Jibe Lighting

Led there be light

Dear Valued Partners,

As you aware that the LED industry and market have been changed tremendously lately, everyone in the LED industry is enjoying the benefits of the technology and also suffering the pain of competition. To face this, Jibe Lighting is committed to be a differentiated lighting solution provider, we will be always extremely flexible in offering varies kinds of product and service.

We are very honored that you choose Jibe Lighting as your business partner. As you expect, we are the technology centered manufacturer, more than 5 million USD R&D investment each year turns out to be a smart strategy. We devote ourselves in researching, developing and manufacturing a full range of qualified lighting products with the most cost-effective solution.

At Jibe lighting, we are proud of our founding principles, our heritage and our customers. We will always keep improving ourselves to become your reliable and trustworthy supply chain.

Thank you for choosing us, we are looking forward to serving you many more years ahead.

Jibe Lighting Team



**MANAGEMENT PHILOSOPHY**  
Quality-centered,  
Customer-oriented.



**MISSION**  
We want to exceed our clients' expectations in terms of quality, innovation and reliability.



**VISION**  
Building a mutual benefit relationship with customers, partners and employees.



**CORE VALUE**

- Customer Focus
- Innovation and Flexibility
- Teamwork and Collaboration
- Commitment
- Continuous Improvement

# ICON INDEX

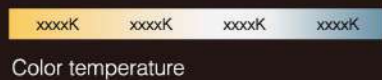
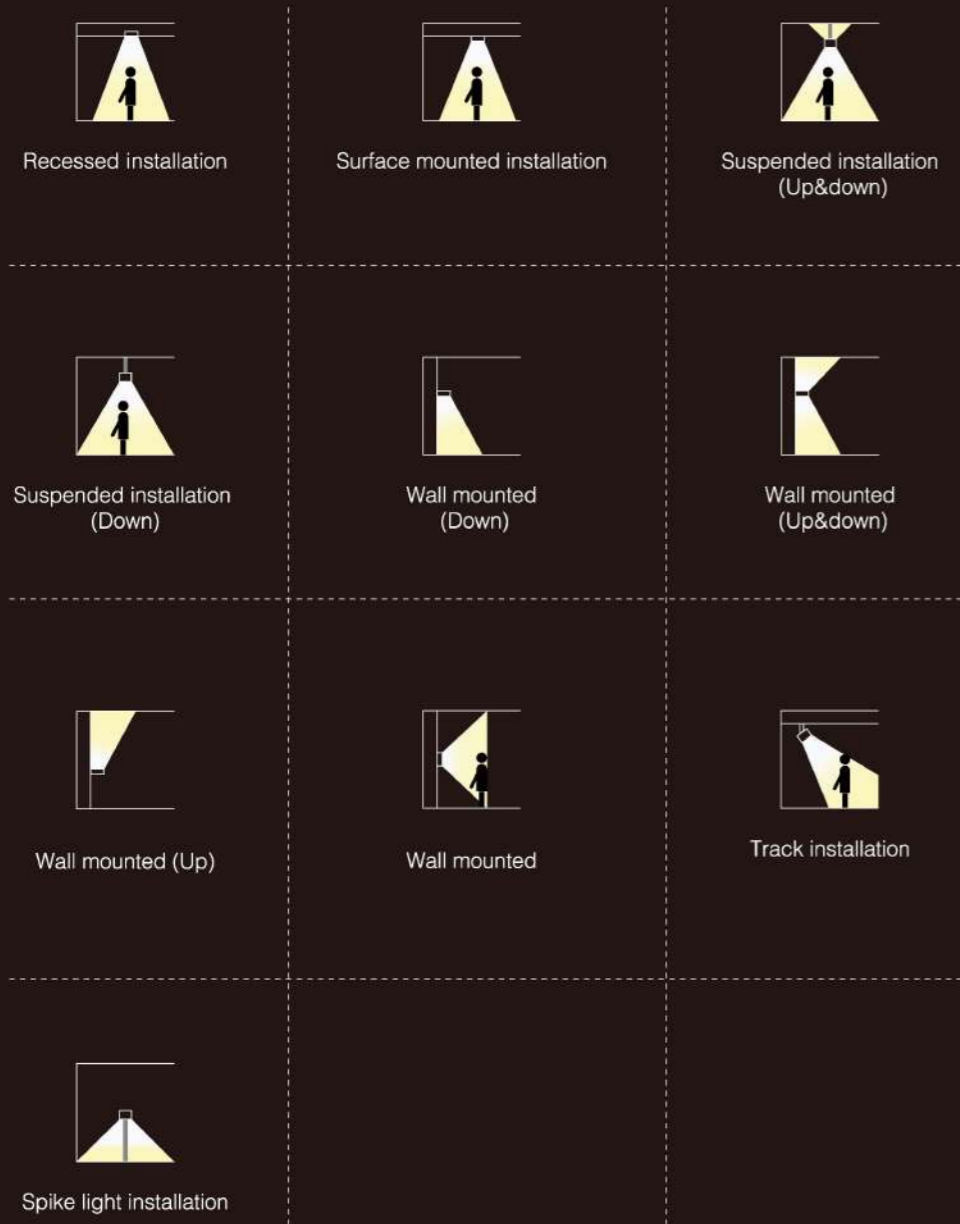

- Beam Angle
- Emergency Function
- Voltage
- Slide Switch Power Changeable Function
- Power Factor
- Smart Lighting
- CRI
- Unified Glare Rating
- Ingress Protection
- Wall Switch CCT Changeable Function
- Dimmable
- RGB Color Adjustable Function
- DALI Dimmable
- Slide Switch CCT Changeable Function
- 0-10V Dimmable
- Tunable White
- 2.4G Int.
- Dim to Warm
- WiFi
- Coverable by Insulation Material
- Remote Control
- SDCM
- PIR Sensor Control
- Classification TP(a)
- Bluetooth Control
- Classification TP(b)
- Music Functionality
- Horizontal Rotation
- Microwave Sensor Function
- Vertical Rotation

# CONTENTS

## LED DOWNLIGHT Ultrathin Series P04-27

				
JDL210 / P04	JDL216 / P05	JDL97 / P06	JCL59 / P07	JDL04 / P08
				
JDL110 / P09	JDL161 / P10	JDL44 / P12	JCL22 / P13	JDL147C / P14
				
JDL147F / P15	JDL141 / P16	JDL150 / P17	JCL88 / P18	JCL30 / P19
				
JDL190 / P20	JDL34 / P21	JDL96 / P22	JDL105 / P23	JDL248A / P24
				
JDL248B / P25	JDL211A / P26	JDL211B / P27		

## LED DOWNLIGHT Integrated Series P28-47

				
JDL222 / P28	JDL222B / P29	JDL94 / P30	JDL134 / P31	JDL54 / P32
				
JDL41 / P33	JDL41-S1 / P34	JDL41D / P35	JDL245 / P36	JDL260 / P38

				
JDL261 / P39	JDL270 / P40	JDL256A / P41	JDL256B / P41	JDL192 / P42
				
JDL174 / P43	JDL199A / P44	JDL199B / P44	JCL101 / P45	JDL91 / P46
				
JDL143 / P47	JDL144 / P47			

## LED DOWNLIGHT COB Series P48-101

				
JDL229 / P48	JDL22 / P49	JDL113 / P50	JDL122 / P51	JDL77 / P52
				
JDL31 / P53	JCL108 / P54	JCL113A / P56	JCL113B / P57	JDL170 / P58
				
JDL206 / P60	JCL103 / P62	JCL103B / P63	JDL201 / P64	JCL117A / P66
				
JCL117B / P66	JCL118A / P66	JCL118B / P66	JCL102 / P68	JDL103 / P69
				
JCL104 / P70	JDL104 / P71	JDL63 / P72	JDL64 / P73	JCL76 / P74

**LED DOWNLIGHT** Surface mounted & Pendant Series P110-131



**LED DOWNLIGHT** Deep-down Series P102-109



**LED CEILING LIGHT** P134-160





JAL42 / P150



JAL48 / P151



JAL45 / P152



JAL52 / P153



JAL55A / P154



JAL55B / P154



JAL65 / P155



JAL66 / P156



JAL96 / P157



JAL91 / P158



JAL91E / P159



JAL104 / P160



JDB38 / P194



JTL04 / P196



JTL04B / P197



JTL04B / P197



JTL04B / P197



JTL13 / P198



JTL13 / P198



JTL13 / P198



JTL13B / P198



JTL13B / P198



JTL13B / P198



JTL14 / P199



JTL19A / P200



JTL19B / P200



JTL19C / P200



JTL19D / P200



JTL19 / P200



JTL19 / P200



JTL19 / P200

## LED TRACK LIGHT P164-200



JTL228 / P164



JTL29A / P168



JTL29B / P169



JTL29C / P170



JTL29D / P171



JTL29E / P172



JTL29F / P173



JTL69A / P175



JTL69B / P175



JTL57A / P176



JTL58A / P177



JTL02 / P178



JTL25 / P180



JTL25B / P181



JTL56 / P182



JTL17 / P183



JTL45 / P184



JTL79 / P186



JTL40A / P188



JTL40B / P189



JTL62 / P190



JTL16 / P191



JTL49 / P192



JTL50 / P193



JTL50B / P193

## LED PANEL LIGHT P218-241

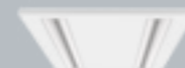

JGL-P / P218



JPL-AZ / P219



JPL-AK / P220



JPL-CB / P221

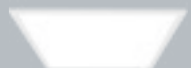

JPL-CK / P222



JPL-CK2 / P224



JPL-CK3 / P225



JPL-AM1 / P226



JPL-AF1 / P227



JPL-G5A / P228



JPL-G6A / P229



JPL-CC / P230



JPL-CD / P231



JPL-BC / P232



JPL-CQ / P233



JPL-CL / P234



JPL-DE / P235



JGL-AA / P236



JGL-N / P237



JPL-DF / P238



JPL-DB / P239



JPL-W / P240

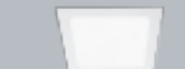

JPL-DD / P241



JPL-DD / P241

@8`@B95 F / '65HH9B'@, <H·D&\*!&\*+

>86**'#D&*	>86()'#D& ,	>86* '\$#D&-	>86)'- '#D& \$	>86 &)'#D& %
>86 %\$* '#D& &	>HFD\$* '#D& (	>86* , '#D&)*	>86% ' '#D&)+	>86+* '#D& ,
>86 \$, '#D&-	>86 (%#D&\$ \$	>86* %'#D& %	>86 (- '#D& &	>5 @/α# '#D&'
>86 \$)'#D& (	>86 %/α 6 '#D&)*	>5 @ \$* '#D&)*	>HFD\$!' '#D&)+	

>K @/α'#D& ,)	>A @ \$* '#D& ,*	>A @ \$+ '#D& ,+)	>B @ \$, '#D& ,	>A @ \$, '#D&- \$
>A @ /, '#D&- &	>A @ \$%#D&- '	>A @ /α '#D&- (	>A @ /% '#D&- )	

@8`HI 69'@, <H·D&- ,!' '\$'

>H, '5 @D7' '#D&- ,	>H, 'D7' '#D' '\$\$	>H' '#D' '\$%	>H) !9' '#D' '\$&	>H) !G'D' '\$'

@8`K5 @@/ 'GD=29'@, <H·D&+\$!&-)

>K @ * '#D&+\$	>K @ + '#D&+&	>K @ \$, '#D&+*	>K @ \$' '#D&+(	>K @ /% '#D&+)
>K @ \$* 5' '#D&+*	>K @ \$* 6' '#D&+&+	>K @ \$+ '#D&+ ,	>K @ \$, '#D&+ -	>K @ - '#D& , \$
>K @ - '#D& , \$	>K @ \$' '#D& , %	>K @ \$&#D& , &	>K @ &#D& , '	>K @ \$%#D& , (

## Tunable white Function introduced:

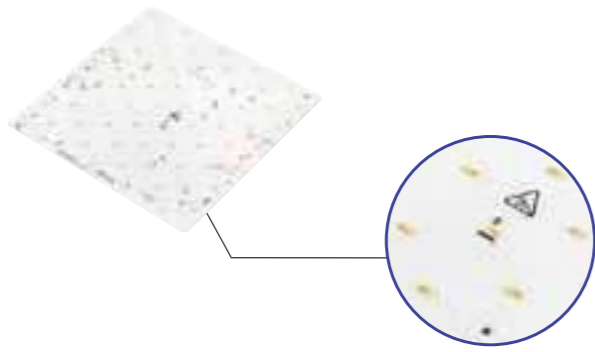

### 2-channel modules – wide range of colour temperatures

The 2-channel modules optimally cover the colour spectrum from 2,700 to 6,500 Kelvin. The different colour temperatures are generated using cool white and warm white LEDs, with two terminals available for each.

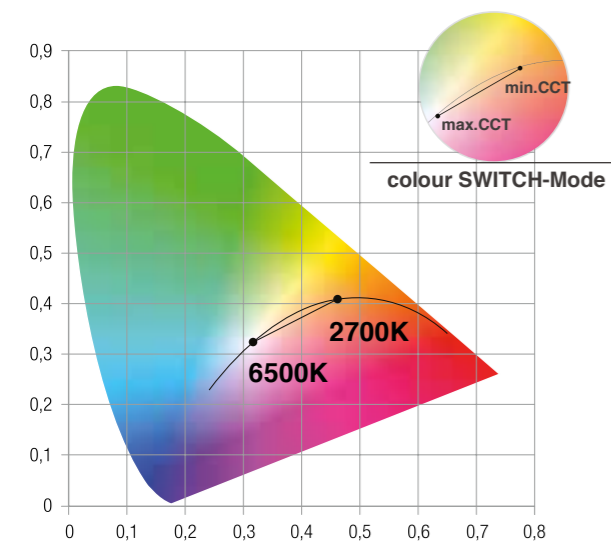

### 2-channel driver JDT8 – constant colorimetric locus across all dimming levels

The second generation drivers guarantee even greater room for manoeuvre in terms of design with the enhanced dimming range of 3% to 100%. Colour temperatures are controlled precisely and with infinite variability, while the drivers reliably maintain the selected range across all dimming levels. The colourSWITCH function makes it possible to select the colour temperature, while the light can be dimmed with the switch DIM function. With the PREMIUM category drivers, the Tunable White solution can be controlled via JDT8 using a push button or touch panel.

## Tunable white Technology application:



### Healthcare

- Improved patient rest and recovery
- Assists shift workers with staying alert while on duty
- Integrates simply with existing Controls



### Behavioral Health

- Reduces sleep disturbance
- Helps prepare residents for sleep (circadian entrainment)
- Reduces depression



### Senior Care

- Reduces yelling, agitation
- Improves sleep quality
- Reduces reliance on certain medications



### Education

- Promotes higher level of student alertness
- Promotes higher cognitive performance in the classroom
- Improves testing and focus



### Correctional

- Keeps staff mentally alert during overnight shifts
- Helps inmates maintain daily circadian rhythms
- Reduces agitation and irritability



### Clean room/Vivarium

- Office workers with lighting that mimics natural patterns experience better sleep and less depression
- Helps entrain laboratory animals ensuring more accurate research outcomes





# LED Downlight /Series/

LED downlight series provide turn-key lighting solutions in domestic and commercial applications. Our downlight is a combination of technique and emotion. We offer our customers a platform to experience the good quality and lighting effects with unique design, 100lm/w and more, UGR<19, Ra80 and Ra90, smart function. Jibe Lighting LED downlight family provides different solutions for project and distribution with different product types: COB/SMD version, IP54/IP44/IP20, recessed/surface mounted/pendant, different sizes, different watts. The export volume of Jibe Lighting downlight is in the top three for three consecutive years according to China export data. Jibe Lighting is your one-stop service supplier for any downlight you're looking for!

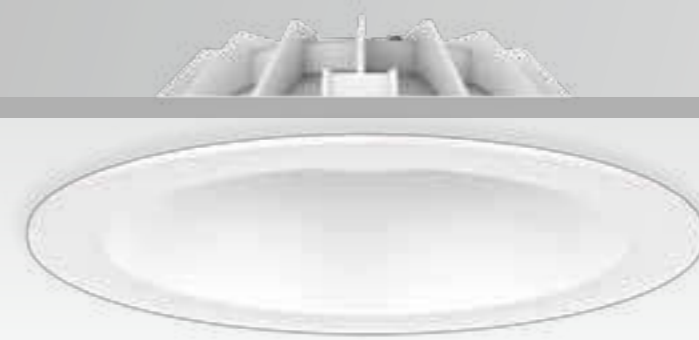

# JDL210 Downlight

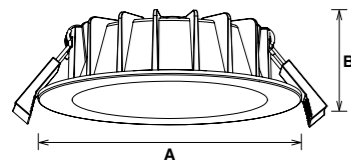

JDL210 LED downlight is with super slim design, external driver, adopting high lumen SMD LED, PC diffuser with uniform light. ADC12 Aluminum profile provides excellent thermal dissipation. Interchangeable CCT with slide switch is available. IP54 waterproof for front side.

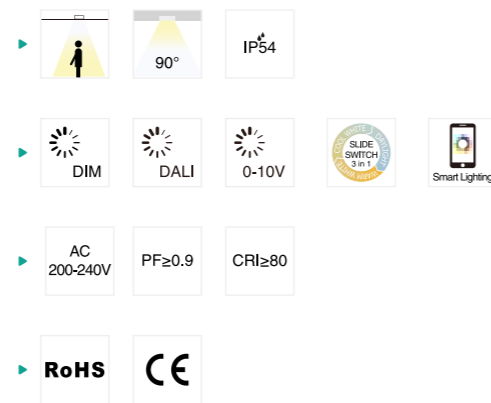

Code	Watt	Size(AxBmm)	Cut-out(mm)	Lumen(±5%)	N.W/pc(kgs)	Q'ty/CTN
JDL210-3-10W	10W	Ø110x30	Ø90-95	960lm	0.25	36PCS
JDL210-3-13W	13W	Ø110x30	Ø90-95	1150lm	0.25	36PCS
JDL210-4-13W	13W	Ø145x30	Ø120-130	1270lm	0.35	30PCS
JDL210-4-18W	18W	Ø145x30	Ø120-130	1980lm	0.35	30PCS
JDL210-6-18W	18W	Ø190x30	Ø160-170	1930lm	0.50	24PCS
JDL210-6-25W	25W	Ø190x30	Ø160-170	2750lm	0.50	24PCS
JDL210-8-25W	25W	Ø225x34	Ø200-210	2630lm	0.65	12PCS
JDL210-8-35W	35W	Ø225x34	Ø200-210	3570lm	0.65	12PCS
JDL210-8-42W	42W	Ø225x34	Ø200-210	4750lm	0.65	12PCS

CCT 3000K 4000K 5000K 5700K

Trim White Black

# JDL216 Downlight

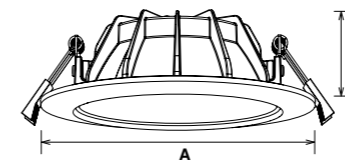

JDL216 LED downlight is with high lumen SMD LED, die casting aluminum ADC12, PC lamp cover, external driver. Deep trim design provides soft lighting for eyes. 3CCT changeable with slide switch is available. IP44 waterproof for front side.

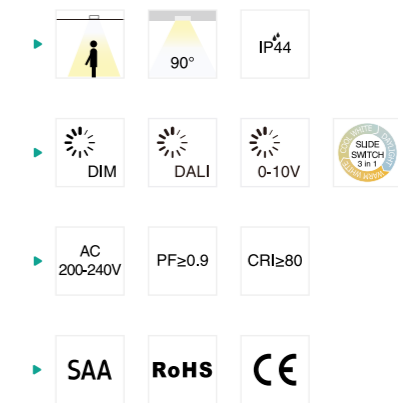

Code	Watt	Size(AxBmm)	Cut-out(mm)	Lumen(±5%)	N.W/pc(kgs)	Q'ty/CTN
JDL216-3-8W	8W	Ø114x45	Ø90-105	790lm	0.20	36PCS
JDL216-3.5-10W	10W	Ø129x45	Ø105-115	1045lm	0.30	36PCS
JDL216-4-13W	13W	Ø152x48	Ø125-140	1355lm	0.45	24PCS
JDL216-5-20W	20W	Ø175x52	Ø145-160	2090lm	0.56	12PCS
JDL216-7-25W	25W	Ø203x56	Ø175-190	2610lm	0.65	12PCS
JDL216-8-33W	33W	Ø228x63	Ø205-215	3445lm	0.76	6PCS

CCT 3000K 4000K 5000K 5700K

Trim White Black



# JDL97 Downlight

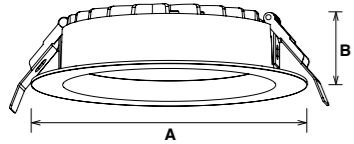

JDL97 LED downlight is with high lumen SMD LED, die casting aluminum ADC12, external driver, IP54 IK06 protection level. CCT changeable by slide switch is available. Full size from 2.5 inch to 8 inch are all available.

- ▶
- ▶
- 
- ▶
- ▶



Code	Watt	Size(AxBmm)	Cut-out(mm)	Lumen(±5%)	N.W/pc(kgs)	Q'ty/CTN
JDL97-2.5-7W	7W	Ø85x39	Ø70-75	590lm	0.20	50PCS
JDL97-3-10W	10W	Ø100x38	Ø90-95	980lm	0.25	36PCS
JDL97-3-13W	13W	Ø100x38	Ø90-95	1300lm	0.25	36PCS
JDL97-3.5-13W	13W	Ø120x45	Ø100-110	1230lm	0.31	30PCS
JDL97-4-15W	15W	Ø145x45	Ø120-130	1600lm	0.46	30PCS
JDL97-5-18W	18W	Ø170x45	Ø140-150	2070lm	0.52	30PCS
JDL97-6-18W	18W	Ø190x45	Ø160-170	1900lm	0.66	20PCS
JDL97-6-25W	25W	Ø190x45	Ø160-170	2680lm	0.66	20PCS
JDL97-6-35W	35W	Ø190x45	Ø160-170	3900lm	0.66	20PCS
JDL97-8-18W	18W	Ø228x45	Ø200-210	2050lm	0.81	10PCS
JDL97-8-25W	25W	Ø228x45	Ø200-210	2650lm	0.81	10PCS
JDL97-8-35W	35W	Ø228x45	Ø200-210	4025lm	0.81	10PCS

CCT — 3000K 4000K 5000K 5700K

Trim — White Black



# JCL59 Downlight

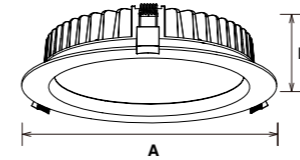

JCL59 LED downlight is with high lumen SMD LED, die casting aluminum ADC12, external driver, IP20 or IP44 available. CCT changeable by slide switch is available. Full size from 2 inch to 10 inch are all available.

- ▶
- ▶
- 
- ▶
- ▶



Code	Watt	Size(AxBmm)	Cut-out(mm)	Lumen(±5%)	N.W/pc(kgs)	Q'ty/CTN
JCL59-2-7W	7W	Ø80x39	Ø60-70	480lm	0.28	50PCS
JCL59-2.5-10W	10W	Ø85x39.5	Ø70-75	730lm	0.24	50PCS
JCL59-3-10W/-F	10W	Ø100x38	Ø90-100	720lm	0.28	24PCS
JCL59-3-12W/-F	12W	Ø110x38	Ø90-100	1170lm	0.28	24PCS
JCL59-3-13W/-F	13W	Ø110x38	Ø90-100	950lm	0.28	24PCS
JCL59-3.5-13W	13W	Ø120x39	Ø100-110	1150lm	0.45	24PCS
JCL59-4-13W	13W	Ø145x45	Ø120-130	950lm	0.59	30PCS
JCL59-4-18W	18W	Ø145x45	Ø120-130	1450lm	0.59	30PCS
JCL59-5-18W	18W	Ø170x45	Ø140-150	1550lm	0.70	30PCS
JCL59-5-25W	25W	Ø170x45	Ø140-150	2100lm	0.70	30PCS
JCL59-6-18W	18W	Ø190x45	Ø160-170	1560lm	0.83	20PCS
JCL59-6-25W	25W	Ø190x45	Ø160-170	2130lm	0.83	20PCS
JCL59-6-35W	35W	Ø190x45	Ø160-170	2830lm	0.83	20PCS
JCL59-8-18W	18W	Ø228x45	Ø200-210	1540lm	0.94	10PCS
JCL59-8-25W	25W	Ø228x45	Ø200-210	2130lm	0.94	10PCS
JCL59-8-35W	35W	Ø228x45	Ø200-210	2790lm	0.94	10PCS
JCL59-10-45W	45W	Ø280x52	Ø230-260	4170lm	1.60	10PCS

CCT — 3000K 4000K 5000K 5700K

Trim — White Black Silver Chrome



## JDL04 Downlight

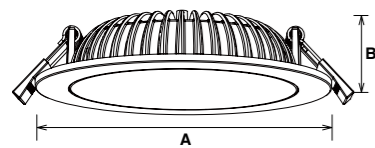

JDL04 LED downlight is with high lumen SMD LED, die casting aluminum ADC12 with good heat dissipation, external driver, Super slim design.

- ▶ 120° IP20
- ▶ DIM DALI 0-10V
- ▶ AC 100-240V AC 200-240V PF≥0.9 CRI≥80
- ▶ SAA RoHS CE



Code	Watt	Size(AxBmm)	Cut-out(mm)	Lumen(±5%)	N.W/pc(kgs)	Q'ty/CTN
JDL04-4-12W	12W	Ø145x31.5	Ø120-135	1170lm	0.38	30PCS
JDL04-6-18W	18W	Ø199x34.5	Ø170-190	1800lm	0.82	20PCS
JDL04-8-24W	24W	Ø245x34.5	Ø210-235	2500lm	0.92	20PCS

CCT — 3000K 4000K 5000K 5700K

Trim — White Black Silver Chrome

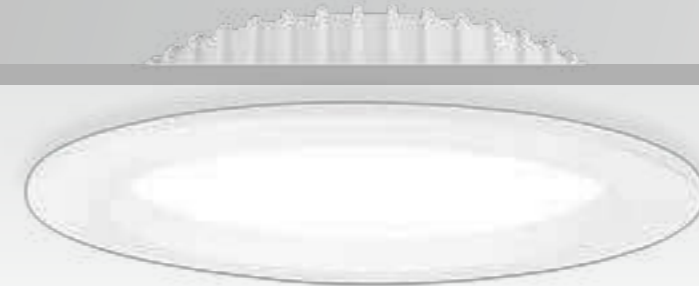

## JDL110 Downlight

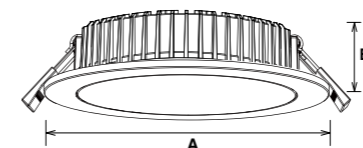

JDL110 LED downlight is with high lumen SMD LED, die casting aluminum ADC12, external driver. IP65 waterproof for indoor and outdoor use.

- ▶ 90° IP65
- ▶ DIM DALI 0-10V
- ▶ AC 200-240V PF≥0.9 CRI≥80
- ▶ SAA RoHS CE



Code	Watt	Size(AxBmm)	Cut-out(mm)	Lumen(±5%)	N.W/pc(kgs)	Q'ty/CTN
JDL110-3-13W	13W	Ø115x55.5	Ø95-100	1320lm	0.40	24PCS
JDL110-4-18W	18W	Ø155x67	Ø120-130	1830lm	0.61	24PCS
JDL110-6-25W	25W	Ø195x46.5	Ø175-185	2550lm	0.75	12PCS
JDL110-8-35W	35W	Ø235x54.5	Ø205-215	3570lm	1.08	12PCS

CCT — 3000K 4000K 5000K 5700K

Trim — White Black Silver Chrome



**ONLY BRIGHT  
NO LIGHT**

# JDL161 Downlight

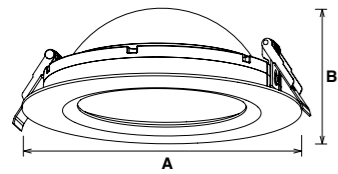

JDL161 LED downlight is with high lumen SMD LED, die casting aluminum ADC12, external driver. Special appearance and Indirect lighting design provides even and soft lighting.

- ▶ 120°
- ▶ DIM DALI 0-10V
- ▶ AC 200-240V PF≥0.9 CRI≥80
- ▶ SAA RoHS CE

Code	Watt	Size(AxBmm)	Cut-out(mm)	Lumen(±5%)	N.W/pc(kgs)	Q'ty/CTN
JDL161-6-10W	10W	Ø185x67	Ø160-170	700lm	0.42	12PCS
JDL161-8-20W	20W	Ø228x88.4	Ø200-210	1520lm	0.59	12PCS



No diffuser covered, it diffuses the light source on the concave sphere heatsink

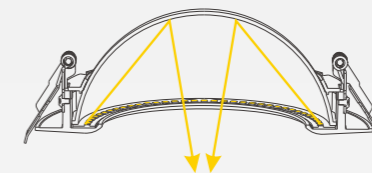

CCT ——— 3000K 4000K 5000K 5700K

Trim ——— White



## JDL44 Downlight

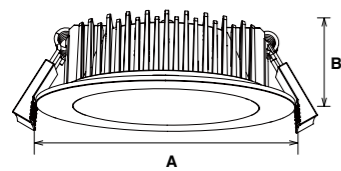

JDL44 LED downlight is with high lumen SMD LED, UL94-V0 Fire-rated PC diffuser, external driver. IP54 waterproof for indoor damp location. Integrated design of heatsink and frame provides more heat dissipation area.

- ▶ 90° IP54
- ▶ DIM DALI 0-10V SLIDE SWITCH 3 in 1
- ▶ AC 100-240V AC 200-240V PF≥0.9 CRI≥80
- ▶ SAA RoHS CE

Code	Watt	Size(AxBmm)	Cut-out(mm)	Lumen(±5%)	N.W/pc(kgs)	Q'ty/CTN
JDL44-3-10W	10W	Ø104x31	Ø90-95	790lm	0.26	24PCS
JDL44-3-13W	13W	Ø104x31	Ø90-95	1070lm	0.26	24PCS

CCT — 3000K 4000K 5000K 5700K

Trim — White Black Silver



## JCL22 Downlight

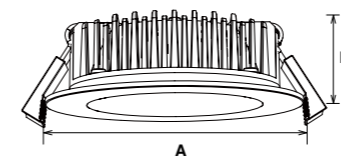

JCL22 LED downlight is with high lumen SMD LED, PMMA diffuser, external driver, IP20 or IP44 available. CCT changeable by slide switch is available.

- ▶ 90° IP44 IP20
- ▶ DIM DALI 0-10V DIM TO WARM
- ▶ SLIDE SWITCH 3 in 1 2.4G WIFI
- ▶ AC 100-240V PF≥0.9 CRI≥80
- ▶ SAA RoHS CE

Code	Watt	Size(AxBmm)	Cut-out(mm)	Lumen(±5%)	N.W/pc(kgs)	Q'ty/CTN
JCL22-2.5-7W	7W	Ø85x31	Ø70-75	480lm	0.35	50PCS
JCL22-2.5-10W	10W	Ø85x31	Ø70-75	740lm	0.35	50PCS
JCL22-3-10W	10W	Ø104x31	Ø90-95	900lm	0.38	24PCS
JCL22-3-13W	13W	Ø104x31	Ø90-95	1075lm	0.38	24PCS

CCT — 3000K 4000K 5000K 5700K

Trim — White Black Silver Chrome



## JDL147C Downlight

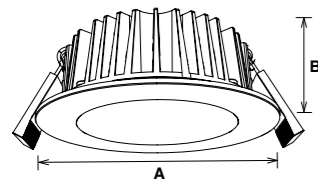

JDL147C LED downlight is with high lumen SMD LED, ADC7 lamp body and frame, PC lamp cover, external driver, IP20 IK06 protection. CCT changeable by slide switch. Round frame for options.

- ▶ 90°
- ▶
- ▶
- ▶

Code	Watt	Size(AxBmm)	Cut-out(mm)	Lumen(±5%)	N.W/pc(kgs)	Q'ty/CTN
JDL147C-3-10W	10W	Ø103x38	Ø90-95	1000lm	0.32	24PCS

CCT — 3000K — 4000K — 5700K

Trim — White Black Silver Chrome



## JDL147F Downlight

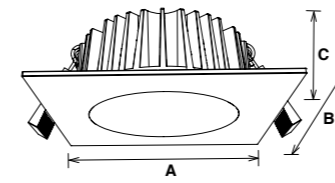

JDL147F LED downlight is with high lumen SMD LED, ADC7 lamp body and frame, PC lamp cover, external driver, IP20 IK06 protection. CCT changeable by slide switch. Square frame for options.

- ▶ 90°
- ▶
- ▶
- ▶

Code	Watt	Size(AxBxCmm)	Cut-out(mm)	Lumen(±5%)	N.W/pc(kgs)	Q'ty/CTN
JDL147F-3-10W	10W	104x104x38	Ø90-95	1000lm	0.34	24PCS

CCT — 3000K — 4000K — 5700K

Trim — White Black Silver Chrome



## JDL141 Downlight

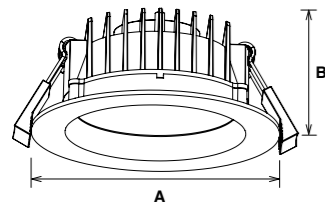

JDL141 LED downlight is with high lumen SMD LED, plastic coated aluminum lamp body, and PC frame, external driver, IP54 IK08 protection available. CCT changeable by slide switch.

- ▶ 90° IP54 IP20
- ▶ DIM SLIDE SWITCH 3 in 1 Smart Lighting
- ▶ AC 200-240V PF≥0.9 CRI≥80
- ▶ SAA RoHS CE

Code	Watt	Size(AxBmm)	Cut-out(mm)	Lumen(±5%)	N.W/pc(kgs)	Q'ty/CTN
JDL141-3-10W	10W	Ø110x39.5	Ø90-100	830lm	0.18	24PCS
JDL141B-3-10W	10W	Ø110x48	Ø90-100	950lm	0.21	24PCS

CCT — 3000K 4000K 5000K 5700K

Trim — White Black



## JDL150 Downlight

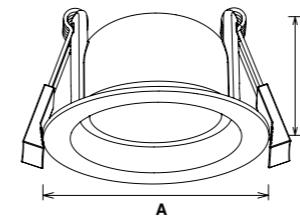

JDL150 LED downlight with SMD LED, external driver. IP44 waterproof. 3CCT switchable by slide switch. Vertical rotation 10° creates diversified lighting effects.

- ▶ 90° 10° IP44
- ▶ DIM SLIDE SWITCH 3 in 1
- ▶ AC 200-240V PF≥0.9 CRI≥80
- ▶ SAA RoHS CE

Code	Watt	Size(AxBmm)	Cut-out(mm)	Lumen(±5%)	N.W/pc(kgs)	Q'ty/CTN
JDL150-2.5-7W	7W	Ø85x50	Ø75-80	455lm	0.21	50PCS

CCT — 3000K 4000K 5000K 5700K

Trim — White





## JCL88 Downlight

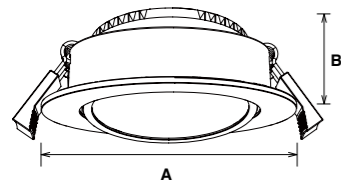

JCL88 LED downlight with SMD LED, ADC12 heat sink, external driver. Cutout size both 70mm and 90mm. Vertical rotation 25° creates diversified lighting effects.

- ▶ 90° 25° IP20
- ▶ DIM DALI 0-10V
- ▶ AC 100-240V AC 200-240V PF≥0.9 CRI≥80
- ▶ SAA RoHS CE

Code	Watt	Size(AxBmm)	Cut-out(mm)	Lumen(±5%)	N.W/pc(kgs)	Q'ty/CTN
JCL88-70-7W	7W	Ø85x28	Ø68	550lm	0.20	50PCS
JCL88-90-10W	10W	Ø104x30	Ø90	800lm	0.28	24PCS

CCT — 3000K 4000K 5000K 5700K

Trim — White Black



## JCL30 Downlight

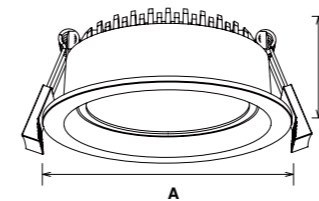

JCL30 LED downlight is with SMD LED, ADC12 heat sink, external driver. Lamp head adjustable provides different lighting direction. Standard and TUYA wireless intelligent solution are available.

- ▶ 90° 25° IP20
- ▶ DIM DALI 0-10V Smart Lighting
- ▶ AC 100-240V AC 200-240V PF≥0.9 CRI≥80
- ▶ SAA RoHS CE

Code	Watt	Size(AxBmm)	Cut-out(mm)	Lumen(±5%)	N.W/pc(kgs)	Q'ty/CTN
JCL30-13W	13W	Ø110x41.5	Ø95-100	900lm	0.40	24PCS

CCT — 3000K 4000K 5000K 5700K

Trim — White Black Silver Chrome



# JDL190 Downlight

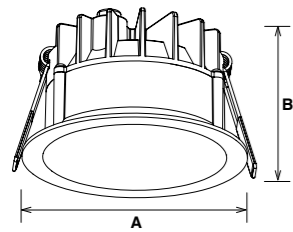

JDL190 LED downlight with high lumen SMD LED, PC-V2 lens, ACD12 lamp body, external driver. Deep trim design provides soft lighting.

- ▶ 60°
- ▶
- ▶
- ▶

Code	Watt	Size(AxBmm)	Cut-out(mm)	Lumen(±5%)	N.W/pc(kgs)	Q'ty/CTN
JDL190-3-10W	10W	Ø100x60	Ø88-93	1040lm	0.22	60PCS

CCT — 3000K 4000K 5000K 5700K

Trim — White Black



# JDL34 Downlight

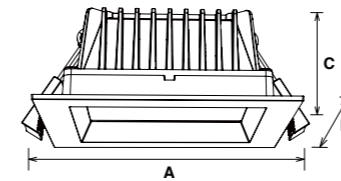

JDL34 LED downlight with high lumen SMD LED, square shape, ADC12 aluminum heat sink, external driver. IP20/IP44 waterproof available.

- ▶ 90°
- ▶
- ▶
- ▶

Code	Watt	Size(AxBxCmm)	Cut-out(mm)	Lumen(±5%)	N.W/pc(kgs)	Q'ty/CTN
JDL34-3-13W	13W	110x110x44	90-95	940lm	0.40	24PCS
JDL34-6-25W	25W	190x190x54	160-170	2300lm	1.11	12PCS

CCT — 3000K 4000K 5000K 5700K

Trim — White Black Silver Chrome



## JDL96 Downlight

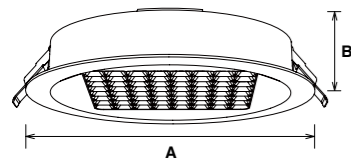

JDL96 LED downlight with SMD LED, plastic coated aluminum, round shape, internal driver. IP54 waterproof. Grilling design effectively reduce the UGR index. High lumen output 110lm/W. Push button looping connection terminal saves much installation time.

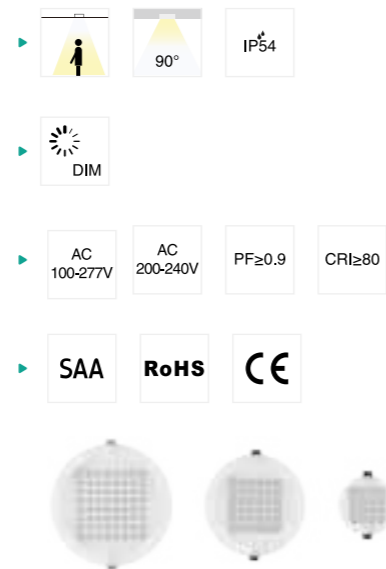

Code	Watt	Size(AxBmm)	Cut-out(mm)	Lumen(±5%)	N.W/pc(kgs)	Q'ty/CTN
JDL96-3-10W	10W	Ø110x40	Ø90-95	1070lm	0.22	30PCS
JDL96-6-18W	18W	Ø190x40	Ø160-170	2070lm	0.44	24PCS
JDL96-8-25W	25W	Ø228x40	Ø200-210	3000lm	0.70	20PCS

CCT 3000K 4000K 5000K 5700K

Trim White Silver

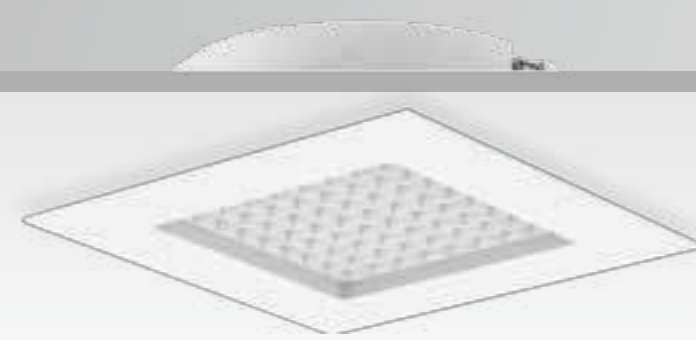

## JDL105 Downlight

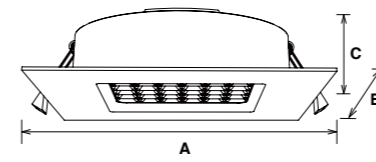

JDL105 LED downlight with SMD LED, plastic coated aluminum, square shape, internal driver. IP54 waterproof. Grilling design effectively reduce the UGR index. High lumen output 110lm/W. Push button looping connection terminal saves much installation time.

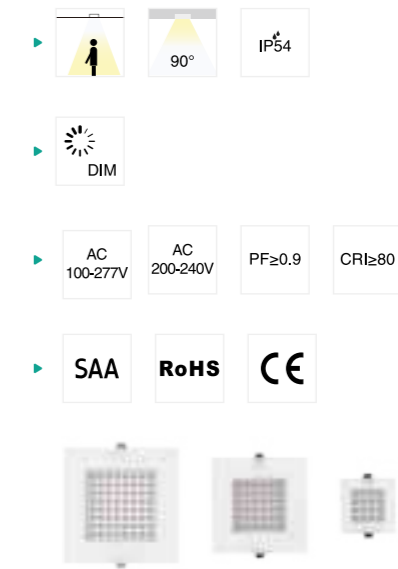

Code	Watt	Size(AxBxCmm)	Cut-out(mm)	Lumen(±5%)	N.W/pc(kgs)	Q'ty/CTN
JDL105-3-10W	10W	110x110x39	90-95	1070lm	0.24	30PCS
JDL105-6-18W	18W	190x190x43.5	160-170	2070lm	0.54	24PCS
JDL105-8-25W	25W	228x228x43.5	200-210	3000lm	0.84	20PCS

CCT 3000K 4000K 5000K 5700K

Trim White Silver



# JDL248A Downlight

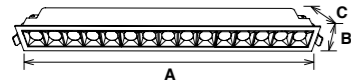

JDL248A is linear recessed downlight with symmetric beam, adopting CREE XP-G big power SMD light source with high lumen, CRI>90, SDCM<6. The aluminum die-casting frame with UV-proof white powder coating finishing provides an excellent thermal management. External flicker free driver and UGR<19 are available.

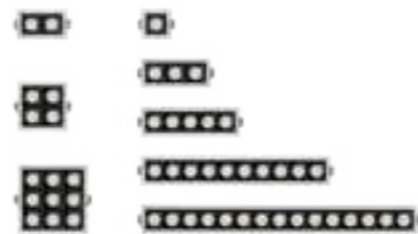
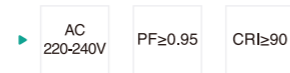

Code	Watt	Size(AxBxCmm)	Cut-out(mm)	Lumen(±5%)	N.W/pc(kgs)	Q'ty/CTN
JDL248A-45-4W	4W	45x45x42	37x37	190lm	0.12	75PCS
JDL248A-76-6W	6W	76x45x51	68x37	370lm	0.16	75PCS
JDL248A-105-9W	9W	105x45x51	97x37	600lm	0.21	50PCS
JDL248A-75-11W	11W	75x75x51	67x67	710lm	0.22	60PCS
JDL248A-147-13W	13W	147x45x51	139x37	940lm	0.27	40PCS
JDL248A-105-23W	23W	105x105x51	97x97	1760lm	0.43	30PCS
JDL248A-280-25W	25W	280x45x51	272x37	1820lm	0.51	20PCS
JDL248A-413-37W	37W	413x45x51	405x37	2830lm	0.71	20PCS

CCT — 2700K — 3000K — 4000K

Trim — White — Black



# JDL248B Downlight

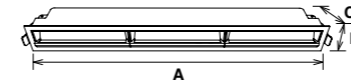

JDL248B is linear recessed downlight with asymmetric beam, adopting CREE XP-G big power SMD light source with high lumen, CRI>90, SDCM<6. The aluminum die-casting frame with UV-proof white powder coating finishing provides an excellent thermal management. External flicker free driver is available.

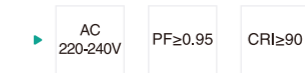

Code	Size a(mm)	Size b(mm)	Size c(mm)
JDL248B-105-9W	600	800	400
JDL248B-147-13W	600	800	400
JDL148B-280-25W	600	900	450
JDL248B-413-37W	600	1000	500

Code	Watt	Size(AxBxCmm)	Cut-out(mm)	Lumen(±5%)	N.W/pc(kgs)	Q'ty/CTN
JDL248B-105-9W	9W	105x45x55	97x37	380lm	0.21	50PCS
JDL248B-147-13W	13W	147x45x55	139x37	690lm	0.27	40PCS
JDL248B-280-25W	25W	280x45x55	272x37	1300lm	0.51	20PCS
JDL248B-413-37W	37W	413x45x55	405x37	2000lm	0.70	20PCS

CCT — 2700K — 3000K — 4000K

Trim — White — Black



## JDL211A Downlight

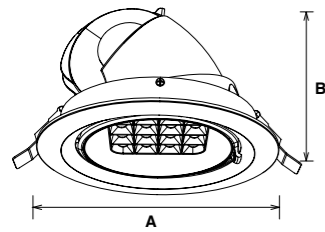

JDL211A LED downlight with high lumen SMD LED, ADC12 lamp body, scoop gimable design, external driver. Model A Lens+louver reflector is anti-glare design with comfortable eye visual. High lumen output up to 120lm/W.

- ▶ IP40
- ▶
- ▶ AC 200-240V PF $\geq$ 0.9 CRI $\geq$ 80 CRI $\geq$ 90
- ▶

Code	Watt	Size(AxBmm)	Cut-out(mm)	Lumen( $\pm$ 5%)	N.W/pc(kgs)	Q'ty/CTN
JDL211A-6-25W	25W	Ø180x126	Ø165-170	2950lm	1.12	12PCS
JDL211A-6-33W	33W	Ø180x126	Ø165-170	3850lm	1.12	12PCS



## JDL211B Downlight

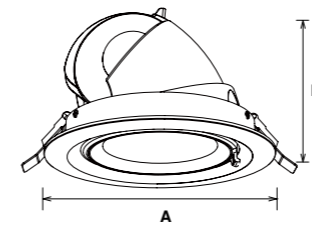

JDL211B LED downlight with high lumen SMD LED, ADC12 lamp body, scoop gimable design, external driver. Model B reflector+ diffuser design provides uniform lighting. CCT changed by slide switch is available.

- ▶ IP40
- ▶
- ▶ AC 200-240V PF $\geq$ 0.9 CRI $\geq$ 80 CRI $\geq$ 90
- ▶

Code	Watt	Size(AxBmm)	Cut-out(mm)	Lumen( $\pm$ 5%)	N.W/pc(kgs)	Q'ty/CTN
JDL211B-6-25W	25W	Ø180x126	Ø165-170	2550lm	1.12	12PCS
JDL211B-6-33W	33W	Ø180x126	Ø165-170	3200lm	1.12	12PCS



# JDL222 Downlight

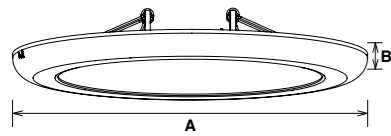

JDL222 LED downlight with SMD LED, AL1060 Aluminum lamp body, AC to DC internal driver, round shape. Recessed and surface mounted installation are available. Cutout size is adjustable from 65mm to 205mm for recessed installation. CCT and power is switchable for choice.

- ▶
- ▶
- ▶
- ▶

Code	Watt	Size(AxBmm)	Cut-out(mm)	Lumen(±5%)	N.W/pc(kgs)	Q'ty/CTN
JDL222-8-16W	16W	Ø235x16	Ø65-205	1800lm	0.36	20PCS
JDL222-8-16W-D	16W	Ø235x16	Ø65-205	1800lm	0.36	20PCS
JDL222-8-16W-A3	10W/13W/16W	Ø235x16	Ø65-205	1800lm	0.36	20PCS
JDL222-8-16W-C3	16W	Ø235x16	Ø65-205	1800lm	0.36	20PCS
JDL222-8-16W-P3	16W	Ø235x16	Ø65-205	1800lm	0.36	20PCS
JDL222-8-16W-AC3	10W/13W/16W	Ø235x16	Ø65-205	1800lm	0.36	20PCS

CCT — 3000K — 4000K — 5000K — 5700K

Trim — White



# JDL222B Downlight

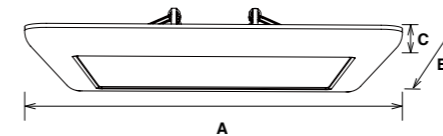

JDL222B LED downlight with SMD LED, AL1060 aluminum lamp body, AC to DC internal driver, square shape. Recessed and surface mounted installation are available. Cutout size is adjustable from 65mm to 205mm for recessed installation. CCT and power is switchable for choice.

- ▶
- ▶
- ▶
- ▶

Code	Watt	Size(AxBxCmm)	Cut-out(mm)	Lumen(±5%)	N.W/pc(kgs)	Q'ty/CTN
JDL222B-8-16W	16W	235x235x16	Ø65-205	1650lm	0.55	20PCS
JDL222B-8-16W-D	16W	235x235x16	Ø65-205	1650lm	0.55	20PCS
JDL222B-8-16W-A3	10W/13W/16W	235x235x16	Ø65-205	1800lm	0.55	20PCS
JDL222B-8-16W-C3	16W	235x235x16	Ø65-205	1800lm	0.55	20PCS
DJL222B-8-16W-P3	16W	235x235x16	Ø65-205	1800lm	0.55	20PCS
JDL222B-8-16W-AC3	10W/13W/16W	235x235x16	Ø65-205	1800lm	0.55	20PCS

CCT — 3000K — 4000K — 5000K — 5700K

Trim — White



## JDL94 Downlight

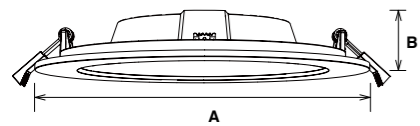

JDL94 LED downlight with SMD LED, plastic coated aluminum heat sink, internal driver. Super slim design only 33mm height.

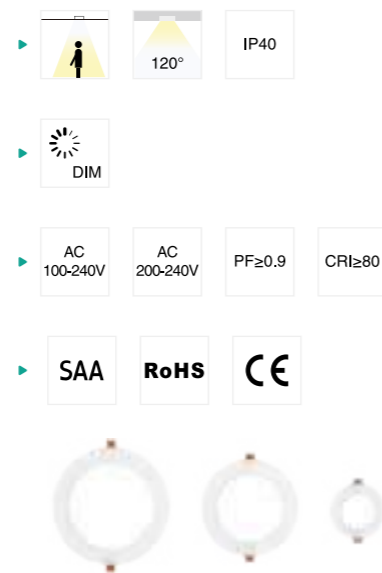

Code	Watt	Size(AxBmm)	Cut-out(mm)	Lumen(±5%)	N.W/pc(kgs)	Q'ty/CTN
JDL94-3-7W	7W	Ø110x30	Ø90-95	580lm	0.15	48PCS
JDL94-6-16W	16W	Ø190x33	Ø160-170	1730lm	0.40	24PCS
JDL94-8-20W	20W	Ø230x33	Ø200-210	2315lm	0.52	24PCS

CCT — 3000K 4000K 5000K 5700K

Trim — White Black



## JDL134 Downlight

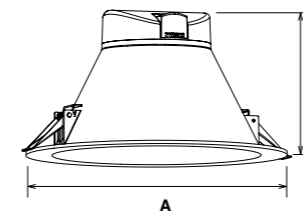

JDL134 LED downlight with SMD LED, plastic coated aluminum heat sink, internal driver. Deep trim design provides soft lighting. IP54 waterproof for internal use. CCT switchable by slide switch is available.

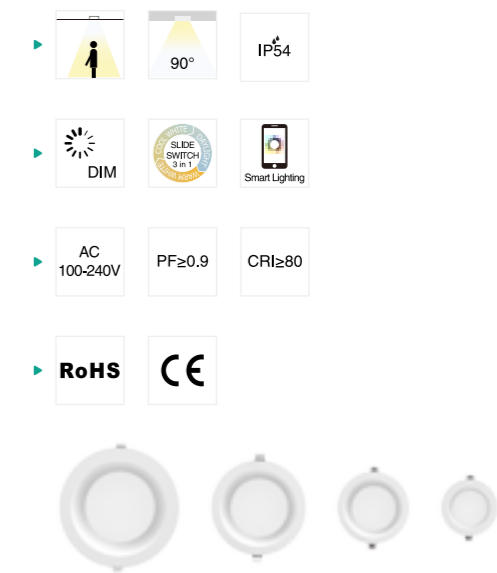

Code	Watt	Size(AxBmm)	Cut-out(mm)	Lumen(±5%)	N.W/pc(kgs)	Q'ty/CTN
JDL134-3-10W	10W	Ø115x83.4	Ø90-95	880lm	0.17	30PCS
JDL134-4-13W	13W	Ø145x97.5	Ø125-130	1230lm	0.25	24PCS
JDL134-6-16W	16W	Ø190x115.3	Ø160-170	1720lm	0.40	12PCS
JDL134-8-20W	20W	Ø240x132.5	Ø200-210	2150lm	0.55	12PCS

CCT — 3000K 4000K 5000K 5700K

Trim — White Silver



# JDL54 Downlight

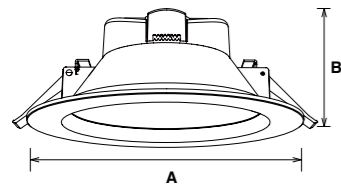

JDL54 LED downlight with SMD LED, plastic coated aluminum heat sink, internal driver. IP40/IP54 available for choice. CCT switchable by slide switch is available.

- ▶
- ▶
- ▶
- ▶



Code	Watt	Size(AxBmm)	Cut-out(mm)	Lumen(±5%)	N.W/pc(kgs)	Q'ty/CTN
JDL54C-2.5-7W-P3	7W	Ø85x68	Ø68-75	700lm	0.13	50PCS
JDL54C-3-8W	8W	Ø115x58	Ø90-95	750lm	0.20	30PCS
JDL54C-3-8W-C3(P3)	8W	Ø115x61	Ø90-95	750lm	0.20	30PCS
JDL54C-3-10W	10W	Ø115x58	Ø90-95	940lm	0.20	30PCS
JDL54C-3-10W-C3(P3)	10W	Ø115x61	Ø90-95	940lm	0.20	30PCS
JDL54B-4-13W	13W	Ø145x61	Ø120-130	1100lm	0.28	30PCS
JDL54B-4-13W-C3(P3)	13W	Ø145x62.5	Ø120-130	1300lm	0.28	30PCS
JDL54B-6-16W	16W	Ø190x74	Ø160-170	1550lm	0.51	30PCS
JDL54B-6-16W-C3(P3)	16W	Ø190x75.5	Ø160-170	1760lm	0.41	30PCS
JDL54B-8-20W	20W	Ø225x84	Ø200-210	1840lm	0.64	20PCS
JDL54B-8-20W-C3(P3)	20W	Ø225x84	Ø200-210	2100lm	0.52	20PCS

CCT — 3000K 4000K 5000K 5700K

Trim — White

Ring — 3inch

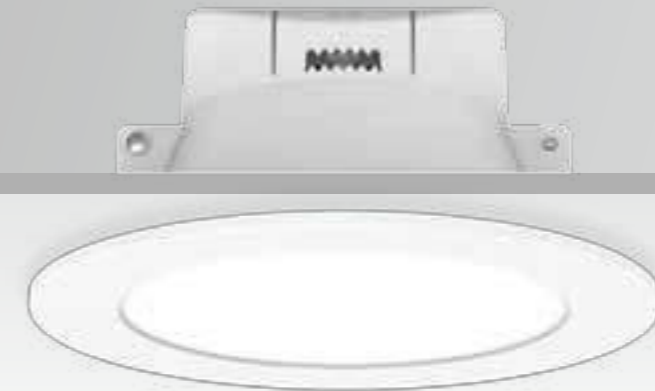

# JDL41 Downlight

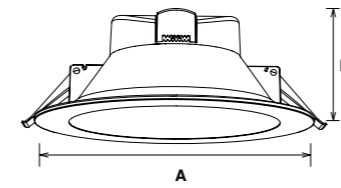

JDL41 LED downlight with SMD LED, PC diffuser, plastic coated aluminum heat sink, internal driver. IP54 waterproof for cover. CCT switchable by slide switch is available.

- ▶
- ▶
- ▶
- ▶



Code	Watt	Size(AxBmm)	Cut-out(mm)	Lumen(±5%)	N.W/pc(kgs)	Q'ty/CTN
JDL41C-2.5-7W	7W	Ø85x55	Ø70-75	620lm	0.12	50PCS
JDL41C-2.5-7W-C3(P3)	7W	Ø85x63	Ø70-75	650lm	0.12	50PCS
JDL41C-3-8W	8W	Ø115x58	Ø90-95	750lm	0.20	30PCS
JDL41C-3-8W-C3(P3)	8W	Ø115x61	Ø90-95	800lm	0.20	30PCS
JDL41C-3-10W	10W	Ø115x58	Ø90-95	880lm	0.20	30PCS
JDL41C-3-10W-C3(P3)	10W	Ø115x61	Ø90-95	940lm	0.20	30PCS
JDL41B-4-13W	13W	Ø145x61	Ø120-130	1210lm	0.22	30PCS
JDL41B-4-13W-C3(P3)	13W	Ø145x62.5	Ø120-130	1320lm	0.22	30PCS
JDL41B-6-16W	16W	Ø190x74	Ø160-170	1670lm	0.51	30PCS
JDL41B-6-16W-C3(P3)	16W	Ø190x75.5	Ø160-170	1840lm	0.51	30PCS
JDL41B-8-20W-C3(P3)	20W	Ø225x84	Ø200-210	2200lm	0.64	20PCS

CCT — 3000K 4000K 5000K 5700K

Trim — White

Ring — 2.5inch / 3inch





# JDL41-S1 Downlight

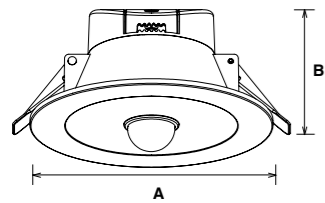

JDL41-S1 LED downlight with PIR sensor function, SMD LED, PC diffuser, plastic coated aluminum heat sink, internal driver. IP54 waterproof for cover. CCT switchable by slide switch is available.

- ▶ 90° IP40
- ▶ SLIDE SWITCH 3 in 1 PIR Sensor
- ▶ AC 200-240V PF≥0.9 CRI≥80
- ▶ RoHS CE

Code	Watt	Size(AxBmm)	Cut-out(mm)	Lumen(±5%)	N.W/pc(kgs)	Q'ty/CTN
JDL41-3-8W-S1	8W	Ø115x70	Ø90-95	730lm	0.20	30PCS
JDL41-3-10W-S1	10W	Ø115x73	Ø90-95	880lm	0.20	30PCS

CCT — 3000K 4000K 5000K 5700K

Trim — White Silver



# JDL41D Downlight

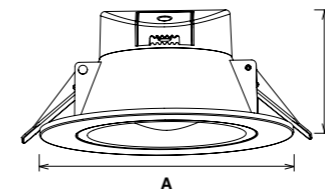

JDL41D LED downlight with SMD LED, high light transmittance lens, plastic coated aluminum heat sink, internal driver. IP54 waterproof for cover. CCT switchable by slide switch is available.

- ▶ 60° IP54 IP40
- ▶ SLIDE SWITCH 3 in 1 DIM
- ▶ AC 200-240V PF≥0.9 CRI≥80
- ▶ SAA RoHS CE

Code	Watt	Size(AxBmm)	Cut-out(mm)	Lumen(±5%)	N.W/pc(kgs)	Q'ty/CTN
JDL41D-3-10W-D	10W	Ø115x58	Ø90-95	900lm	0.20	30PCS
JDL41D-3-10W-P3	10W	Ø115x61	Ø90-95	980lm	0.20	30PCS

CCT — 3000K 4000K 5000K 5700K

Trim — White Silver



# JDL245 Downlight

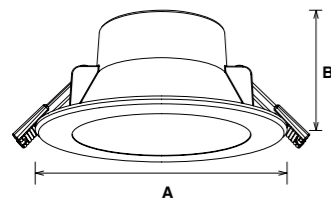

JDL245 CCT switchable downlight adopts high efficiency SMD LED chips, opal PC diffuser and plastic covered aluminium housing. Internal dimmable driver is compatible with most dimmers in the market with smooth dimming performance.

- ▶ 90° IP44
- ▶ DIM 3 in 1
- ▶ AC 220-240V PF≥0.9 CRI≥80
- ▶ RoHS CE

Code	Watt	Size(AxBmm)	Cut-out(mm)	Lumen(±5%)	N.W/pc(kgs)	Q'ty/CTN
JDL245-3-8W-P3	8W	Ø115x54	Ø90-95	800lm	0.16	24PCS

CCT — 3000K 4000K 5700K

Trim — White Black Silver Chrome





## JDL260 Downlight

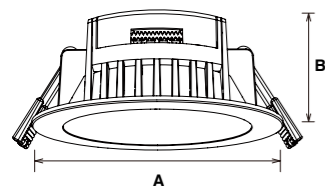

JDL260 slimline downlight adopts high efficiency SMD LED chips, opal PC diffuser and plastic covered aluminium housing. Flat surface design integrates well into ceiling. Internal dimmable driver is compatible with most dimmers in the market with smooth dimming performance.

- ▶ 110° IP54 IP40
- ▶ DIM SLIDE SWITCH 3 in 1
- ▶ AC 200-240V PF ≥ 0.9 CRI ≥ 80
- ▶ SAA RoHS CE

Code	Watt	Size(AxBmm)	Cut-out(mm)	Lumen(±5%)	N.W/pc(kgs)	Q'ty/CTN
JDL260A-3-8W	8W	Ø106x40	Ø90-95	800lm	0.15	45PCS
JDL260B-3-8W	8W	Ø106x40	Ø90-95	800lm	0.19	45PCS



## JDL261 Downlight

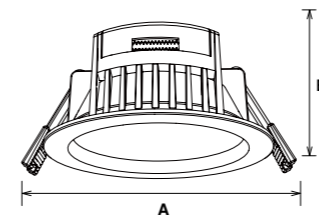

JDL261 slimline downlight adopts high efficiency SMD LED chips, opal PC diffuser and plastic covered aluminium housing. Stepped surface design reduces glare rate effectively. Internal dimmable driver is compatible with most dimmers in the market with smooth dimming performance.

- ▶ 90° IP20
- ▶ DIM SLIDE SWITCH 3 in 1
- ▶ AC 200-240V PF ≥ 0.9 CRI ≥ 80
- ▶ SAA RoHS CE

Code	Watt	Size(AxBmm)	Cut-out(mm)	Lumen(±5%)	N.W/pc(kgs)	Q'ty/CTN
JDL261A-3-8W	8W	Ø106x47	Ø90-95	800lm	0.20	30PCS
JDL261B-3-8W	8W	Ø106x47	Ø90-95	800lm	0.20	30PCS



JDL256A



JDL256B

## JDL270 Downlight

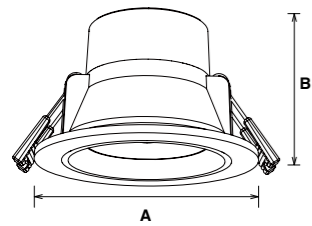

JDL270 LED downlight is low UGR design with internal driver, adopting high lumen SMD which could reach 105lm/W, special lens with uniform and soft lighting, quick terminal makes installation easier. The plastic coated aluminum improves the stability and safety. Interchangeable CCT with slide switch is available.

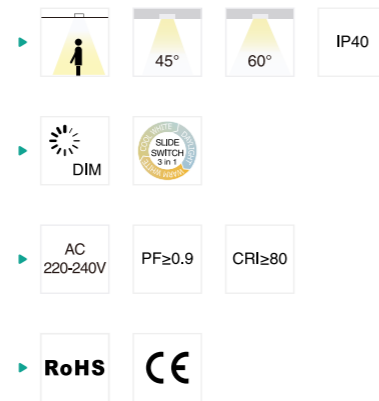

Code	Watt	Size(AxBmm)	Cut-out(mm)	Lumen(±5%)	N.W/pc(kgs)	Q'ty/CTN
JDL270-2.5-5W-D	5W	Ø85x55	Ø68-75mm	530lm	0.15	50PCS
JDL270-2.5-5W-P3	5W	Ø85x57.5	Ø68-75mm	530lm	0.19	50PCS

CCT — 3000K — 4000K — 5000K — 5700K

Trim — White

## JDL256 Downlight

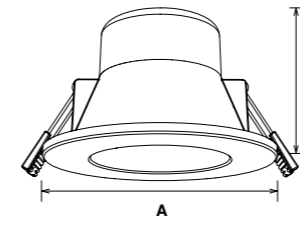

JDL256 compact downlight adopts high efficiency SMD LED chips, opal PC diffuser and plastic covered aluminium housing. Front CCT adjustable switch, with exchangeable bezels magnetic onto main body. Internal dimmable driver is compatible with most dimmers in the market with smooth dimming performance.

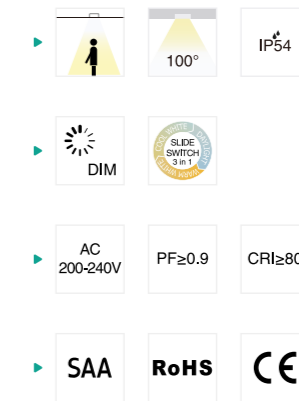

Code	Watt	Size(AxBmm)	Cut-out(mm)	Lumen(±5%)	N.W/pc(kgs)	Q'ty/CTN
JDL256A-3-8W-P3	8W	Ø110x67.5	Ø90-95mm	820lm	0.15	36PCS
JDL256B-3-8W -P3	8W	Ø110x67.5	Ø90-95mm	820lm	0.17	36PCS

CCT — 3000K — 4000K — 5700K

Trim — White



## JDL192 Downlight

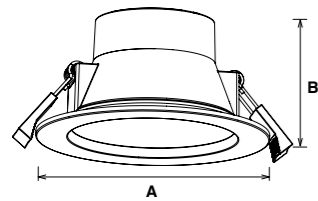

JDL192 compact downlight adopts high efficiency SMD LED chips, opal PC diffuser and plastic covered aluminium housing. Stepped surface design reduces glare rate effectively. Internal dimmable driver is compatible with most dimmers in the market with smooth dimming performance.

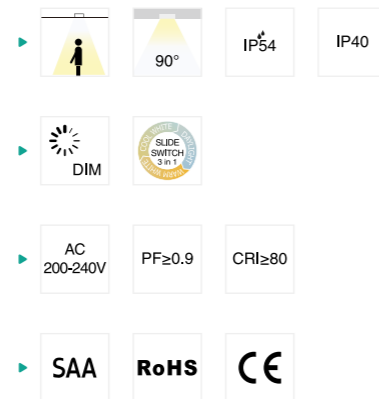

Code	Watt	Size(AxBmm)	Cut-out(mm)	Lumen(±5%)	N.W/pc(kgs)	Q'ty/CTN
JDL192-3-10W-D	10W	Ø115x60	Ø90-95	870lm	0.18	30PCS
JDL192-3-10W-P3	10W	Ø115x62.6	Ø90-95	1000lm	0.18	30PCS



## JDL174 Downlight

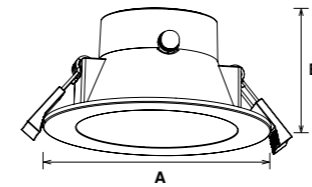

JDL174 compact downlight adopts high efficiency SMD LED chips, opal PC diffuser and plastic covered aluminium housing. Flat surface design integrates well into ceiling. Internal dimmable driver is compatible with most dimmers in the market with smooth dimming performance.

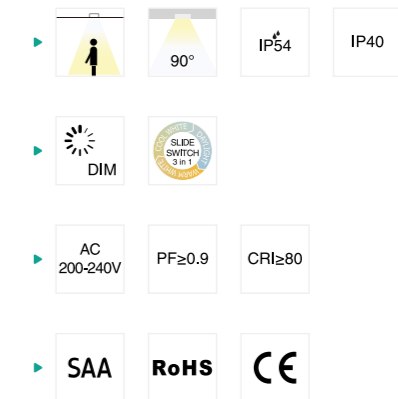

Code	Watt	Size(AxBmm)	Cut-out(mm)	Lumen(±5%)	N.W/pc(kgs)	Q'ty/CTN
JDL174-2.5-7W-D	7W	Ø85x57	Ø68-75	630lm	0.14	50PCS
JDL174-2.5-7W-P3	7W	Ø85x59.6	Ø68-75	720lm	0.14	50PCS
JDL174-3-10W-D	10W	Ø115x57	Ø90-95	870lm	0.18	30PCS
JDL174-3-10W-P3	10W	Ø115x59.6	Ø90-95	1000lm	0.18	30PCS

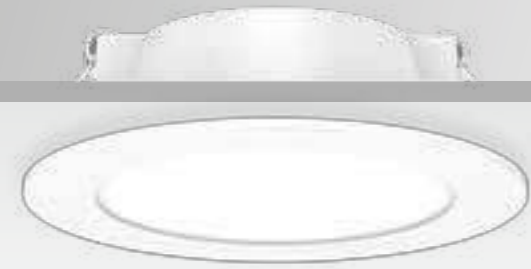

JDL199A



JDL199B



## JDL199 Downlight

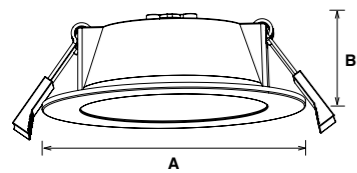

JDL199 slimline downlight adopts high efficiency SMD LED chips, opal PC diffuser and plastic covered aluminium housing. Flat (A) or Stepped (B) surface design optional. Internal DOB driver for single CCT version. External linear driver integrated with slide switch for Tri-CCT version. Dimmable driver is compatible with most dimmers in the market with smooth dimming performance.

- ▶ 90° IP54
- ▶ DIM SLIDE SWITCH 3 in 1
- ▶ AC 200-240V PF ≥ 0.7 CRI ≥ 80
- ▶ SAA RoHS CE

Code	Watt	Size(AxBmm)	Cut-out(mm)	Lumen(±5%)	N.W/pc(kgs)	Q'ty/CTN
JDL199A-3-7W-D	7W	Ø115x40	Ø90-95	630lm	0.12	30PCS
JDL199A-3-7W-P3	7W	Ø115x40	Ø90-95	650lm	0.12	30PCS
JDL199B-3-7W-D	7W	Ø115x43	Ø90-95	630lm	0.12	30PCS
JDL199B-3-7W-P3	7W	Ø115x43	Ø90-95	650lm	0.12	30PCS

CCT — 3000K 4000K 5000K 5700K

Trim — White

## JCL101 Downlight

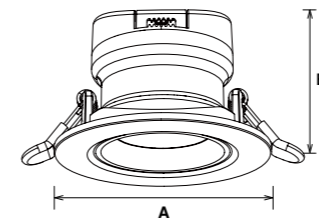

JCL101 rotatable downlight adopts high efficiency SMD LED chips, TIR (Total Internal Reflection) lens and plastic covered aluminium housing. Sharp light distribution makes it an ideal choice for accent lighting purpose.

- ▶ 36° 60° 30° IP40
- ▶ DIM
- ▶ AC 200-240V PF ≥ 0.9 CRI ≥ 80
- ▶ SAA RoHS CE

Code	Watt	Size(AxBmm)	Cut-out(mm)	Lumen(±5%)	N.W/pc(kgs)	Q'ty/CTN
JCL101-2.5-7W	7W	Ø85x64.5	Ø70-75	660lm	0.20	36PCS
JCL101-3-10W	10W	Ø105x71.5	Ø90-95	950lm	0.25	36PCS

CCT — 3000K 4000K 5000K 5700K

Trim — White



# JDL91 Downlight

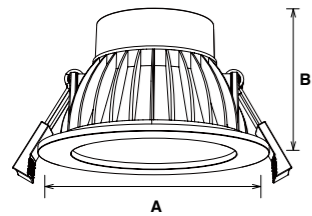

JDL91 integrated downlight adopts high efficiency SMD LED chips, opal PC diffuser, plastic covered aluminium housing and internal dimmable driver. Dimmable driver is compatible with most dimmers in the market with smooth dimming performance. Dual-CCT or Tri-CCT switchable optional. Silver, white and black exchangeable rings.

- ▶ 90° IP54 IP40
- ▶ DIM SLIDE SWITCH 3 in 1
- ▶ AC 200-240V PF ≥ 0.9 CRI ≥ 80
- ▶ SAA RoHS CE

Code	Watt	Size(AxBmm)	Cut-out(mm)	Lumen(±5%)	N.W/pc(kgs)	Q'ty/CTN
JDL91-3-8W-P2	8W	Ø107.5x71.5	Ø90-95	780lm	0.29	30PCS
JDL91-3-10W-P2	10W	Ø107.5x71.5	Ø90-95	900lm	0.29	30PCS
JDL91-3-8W-P3	8W	Ø107.5x71.5	Ø90-95	800lm	0.29	30PCS
JDL91-3-10W-P3	10W	Ø107.5x71.5	Ø90-95	900lm	0.29	30PCS

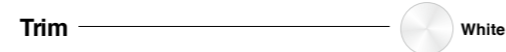
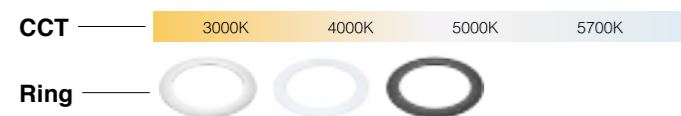

# JDL143 & JDL144 Downlight

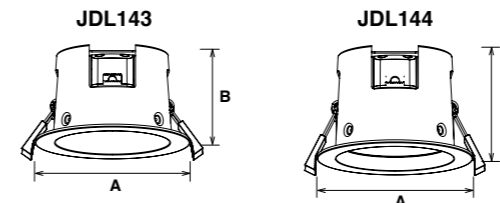

JDL143 RGB smart downlight adopts Tuya wireless intelligent solution. Each lamp could be controlled individually or by grouping through corresponding app for different lighting application needs: CCT adjustable from 3000K~5700K / RGB, brightness adjustable, synchronizing with music. Work with ALEXA, GOOGLE Assistant, IFTTT, ROKID, Tmall Genie etc.

- ▶ 90° IP54
- ▶ DIM SLIDE SWITCH 3 in 1 2.4G WIFI
- Bluetooth Music RGB Smart Lighting
- ▶ AC 200-240V PF ≥ 0.5 CRI ≥ 80
- ▶ SAA RoHS CE

Code	Watt	Size(AxBmm)	Cut-out(mm)	Lumen(±5%)	N.W/pc(kgs)	Q'ty/CTN
JDL143-3-10W	10W	Ø110x64	Ø90-95	850lm	0.22	36PCS
JDL144-3-10W	10W	Ø110x74	Ø90-95	780lm	0.24	36PCS





# JDL229 Downlight

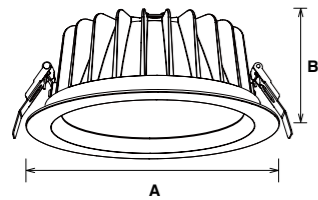

JDL229 commercial downlight adopts high power COB LED chip, reflector and tempered glass, ADC12 aluminum heatsink. External driver is exchangeable through quick connector among non-dimmable driver, Triac dimmable, 0-10V and DALI dimmable drivers.

- Beam angles: 24°, 36°, 45°, 60°
- IP54
- Dimming: DIM, DALI, 0-10V
- Electrical: AC 200-240V, PF≥0.9, CRI≥80, CRI≥90, CRI≥97, SDCM <6
- Certifications: SAA, RoHS, CE

Code	Watt	Size(AxBmm)	Cut-out(mm)	Lumen(±5%)	N.W/pc(kgs)	Q'ty/CTN
JDL229-3-10W	10W	Ø110x53	Ø90-95	988lm	0.25	30PCS
JDL229-3-12W	12W	Ø110x53	Ø90-95	1312lm	0.25	30PCS
JDL229-4-12W	12W	Ø145x65	Ø120-130	1485lm	0.41	20PCS
JDL229-4-18W	18W	Ø145x65	Ø120-130	1997lm	0.41	20PCS
JDL229-4-25W	25W	Ø145x65	Ø120-130	2733lm	0.41	20PCS
JDL229-6-18W	18W	Ø190x75	Ø160-170	2079lm	0.69	12PCS
JDL229-6-25W	25W	Ø190x75	Ø160-170	2798lm	0.69	12PCS
JDL229-6-33W	33W	Ø190x75	Ø160-170	3674lm	0.69	12PCS
JDL229-8-18W	18W	Ø225x87	Ø200-210	2066lm	0.96	12PCS
JDL229-8-25W	25W	Ø225x87	Ø200-210	2801lm	0.96	12PCS
JDL229-8-33W	33W	Ø225x87	Ø200-210	3659lm	0.96	12PCS
JDL229-8-42W	42W	Ø225x87	Ø200-210	4823lm	0.96	12PCS

CCT 2700K 3000K 4000K 5000K

Trim White Black



# JDL22 Downlight

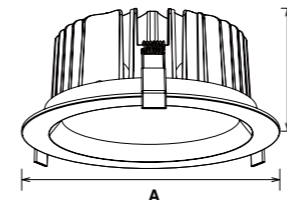

JDL22 the most classic commercial downlight adopts brand CITIZEN COB, reflector and tempered glass, ADC12 aluminum heatsink and bezel. The sophisticated ADC12 heatsink design is unique and serves the purpose of superb heat dissipation. External driver is exchangeable through quick connector among non-dimmable driver, Triac dimmable, 0-10V and DALI dimmable drivers. Tunable White option adopts dual color temperature COB and dual DALI driver, supports the concept of Human Centric Lighting (HCL), widely applicable in health care center, nursing home, school etc.

- Beam angles: 24°, 36°, 45°, 60°
- IP44 IP20
- Dimming: DIM, DALI, 0-10V, TUNABLE WHITE, SLIDE SWITCH 3:1:1
- Electrical: AC 100-240V, AC 200-240V, PF≥0.9, CRI≥80, CRI≥90, CRI≥97
- Certifications: SAA, RoHS, CE

Code	Watt	Size(AxBmm)	Cut-out(mm)	Lumen(±5%)	N.W/pc(kgs)	Q'ty/CTN
JDL22-3-10W	10W	Ø110x53	Ø90-100	800lm	0.35	30PCS
JDL22-3-13W	13W	Ø110x53	Ø90-100	1100lm	0.35	30PCS
JDL22-4-18W	18W	Ø145x65	Ø120-130	2105lm	0.85	20PCS
JDL22-4-25W	25W	Ø145x65	Ø120-130	2750lm	0.85	20PCS
JDL22-6-18W	18W	Ø190x75	Ø160-170	2160lm	1.04	12PCS
JDL22-6-25W	25W	Ø190x75	Ø160-170	2875lm	1.04	12PCS
JDL22-6-35W	35W	Ø190x75	Ø160-170	3955lm	1.08	12PCS
JDL22-6-45W	45W	Ø190x75	Ø160-170	4770lm	1.08	12PCS
JDL22-8-18W	18W	Ø225x87	Ø200-210	2160lm	1.48	12PCS
JDL22-8-25W	25W	Ø225x87	Ø200-210	2875lm	1.48	12PCS
JDL22-8-35W	35W	Ø225x87	Ø200-210	3955lm	1.48	12PCS
JDL22-8-45W	45W	Ø225x87	Ø200-210	4770lm	1.48	12PCS

CCT 2700K 3000K 4000K 5000K

Trim White Black Silver





# JDL113 Downlight

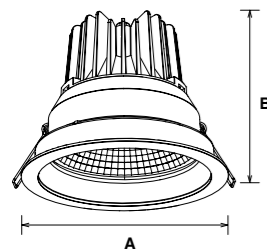

JDL113 unique downlight adopts brand CITIZEN COB, reflector and tempered glass, ADC12 aluminum heatsink. Deep reflector reduces glare rate effectively. External driver is exchangeable through quick connector among non-dimmable driver, Triac dimmable, 0-10V and DALI dimmable drivers.

- ▶ 60° IP20
- ▶ DIM DALI 0-10V
- ▶ AC 200-240V PF≥0.9 CRI≥80 CRI≥90 CRI≥97
- ▶ SAA RoHS CE

Code	Watt	Size(AxBmm)	Cut-out(mm)	Lumen(±5%)	N.W/pc(kgs)	Q'ty/CTN
JDL113-4-13W	13W	Ø150x123	Ø135-140	1520lm	0.85	12PCS
JDL113-4-20W	20W	Ø150x123	Ø135-140	2280lm	0.85	12PCS
JDL113-4-25W	25W	Ø150x123	Ø135-140	2810lm	0.85	12PCS

CCT — 2700K 3000K 4000K 5000K

Trim — White Black Silver



# JDL122 Downlight

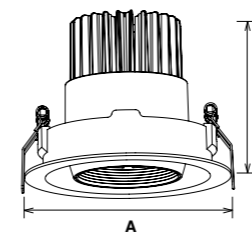

JDL122 Gimbal downlight adopts brand CITIZEN COB, exchangeable reflector and tempered glass, ADC12 aluminum heatsink. Horizontally 355° and vertically 30° rotatable. External driver is exchangeable through quick connector among non-dimmable driver, Triac dimmable, 0-10V and DALI dimmable drivers.

- ▶ 24° 45° 60° 355° 30° IP20
- ▶ DIM DALI 0-10V
- ▶ AC 200-240V PF≥0.9 CRI≥80 CRI≥90 CRI≥97
- ▶ SAA RoHS CE

Code	Watt	Size(AxBmm)	Cut-out(mm)	Lumen(±5%)	N.W/pc(kgs)	Q'ty/CTN
JDL122-4-18W	18W	Ø150x116	Ø130-140	1820lm	0.71	12PCS
JDL-122--4-25W	25W	Ø150x116	Ø130-140	2430lm	0.71	12PCS
JDL122-6-25W	25W	Ø185x130	Ø160-170	2420lm	1.10	12PCS
JDL122-6-35W	35W	Ø185x130	Ø160-170	3260lm	1.10	12PCS
JDL122-6-42W	42W	Ø185x130	Ø160-170	3780lm	1.10	12PCS

CCT — 2700K 3000K 4000K 5000K

Trim — White Black



# JDL77 Downlight

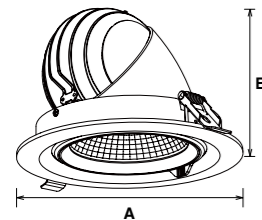

JDL77 Gimbal downlight adopts brand CITIZEN COB, reflector and tempered glass, ADC12 aluminum heatsink. External driver is exchangeable through quick connector among non-dimmable driver, Triac dimmable, 0-10V and DALI dimmable drivers.

- ▶ 15° 24° 36° 45° 60°
- ▶ 350° 35°
- ▶ 45°
- ▶ IP20
- ▶ DIM DALI 0-10V
- ▶ AC 200-240V PF≥0.9 CRI≥80 CRI≥90 CRI≥97
- ▶ RoHS CE CB

Code	Watt	Size(AxBmm)	Cut-out(mm)	Lumen(±5%)	N.W/pc(kgs)	Q'ty/CTN
JDL77-2.5-10W	10W	Ø96x68	Ø85-90	800lm	0.25	36PCS
JDL77-4-15W	15W	Ø145x102	Ø120-130	1800lm	0.57	18PCS
JDL77-4-20W	20W	Ø145x102	Ø120-130	2100lm	0.57	18PCS
JDL77-6-35W	35W	Ø180x128.5	Ø165-170	3800lm	1.07	12PCS
JDL77-6-45W	45W	Ø180x128.5	Ø165-170	5080lm	1.07	12PCS

CCT  2700K 3000K 4000K 5000K

Trim  White  Black  Silver

# JDL31 Downlight

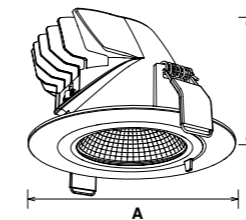

JDL31 Gimbal downlight adopts brand CITIZEN COB, reflector and tempered glass, ADC12 aluminum heatsink. External driver is exchangeable through quick connector among non-dimmable driver, Triac dimmable, 0-10V and DALI dimmable drivers.

- ▶ 24° 45° 60° 45°
- ▶ IP20
- ▶ DIM DALI 0-10V
- ▶ AC 100-240V AC 200-240V PF≥0.9 CRI≥80 CRI≥90 CRI≥97
- ▶ SAA RoHS CE

Code	Watt	Size(AxBmm)	Cut-out(mm)	Lumen(±5%)	N.W/pc(kgs)	Q'ty/CTN
JDL31-2.5-13W	13W	Ø96x67	Ø85-88	945lm	0.39	24PCS
JDL31-6-18W	18W	Ø180x100	Ø160-170	1530lm	1.41	12PCS
JDL31-6-25W	25W	Ø180x100	Ø160-170	2550lm	1.41	12PCS
JDL31-6-35W	35W	Ø180x100	Ø160-170	3550lm	1.41	12PCS

CCT  2700K 3000K 4000K 5000K

Trim  White  Black  Silver  Chrome



# JCL108 Downlight

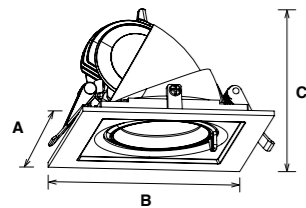

JCL108 Gimbal downlight adopts brand CITIZEN COB, reflector and tempered glass, ADC12 aluminum heatsink. Square modular design allows various DIY combinations through splicing plates. External driver is exchangeable through quick connector among non-dimmable driver, Triac dimmable, 0-10V and DALI dimmable drivers.

- ▶ 15° 24° 36° 45°
- ▶ 60° 350° 35°
- ▶ IP20
- ▶ DIM DALI 0-10V
- ▶ AC 200-240V PF $\geq$ 0.9 CRI $\geq$ 80 CRI $\geq$ 90 CRI $\geq$ 97
- ▶ RoHS CE



Code	Watt	Size(AxBxCmm)	Cut-out(mm)	Lumen(±5%)	N.W/pc(kgs)	Q'ty/CTN
JCL108-2.5-10W	10W	100x100x70	85-85	780lm	0.29	36PCS
JCL108-4-15W	15W	145x145x107	125-125	1290lm	0.60	18PCS
JCL108-4-20W	20W	145x145x107	125-125	2100lm	0.60	18PCS
JCL108-6-35W	35W	180x180x129	165-165	3800lm	1.07	12PCS
JCL108-6-45W	45W	180x180x129	165-165	4350lm	1.07	12PCS

CCT — 2700K 3000K 4000K 5000K

Trim — White Black



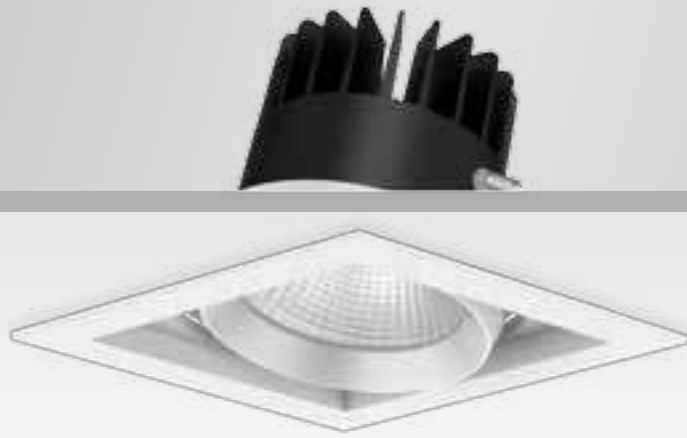

# JCL113A Downlight

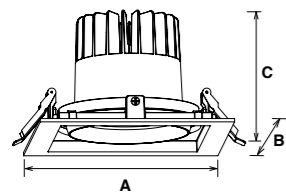

JCL113A Gimbal downlight adopts brand CITIZEN COB, reflector and tempered glass, ADC12 aluminum heatsink. Square modular design allows various DIY combinations through splicing plates. External driver is exchangeable through quick connector among non-dimmable driver, Triac dimmable, 0-10V and DALI dimmable drivers.

- ▶
- ▶
- ▶
- ▶



Code	Watt	Size(AxBxCmm)	Cut-out(mm)	Lumen(±5%)	N.W/pc(kgs)	Q'ty/CTN
JCL113A-6-25W	25W	175x175x110	150-160	2750lm	0.83	18PCS
JCL113A-6-35W	35W	175x175x110	150-160	3850lm	0.83	18PCS



# JCL113B Downlight

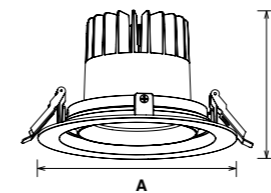

JCL113B Gimbal downlight adopts brand CITIZEN COB, reflector and tempered glass, ADC12 aluminum heatsink. External driver is exchangeable through quick connector among non-dimmable driver, Triac dimmable, 0-10V and DALI dimmable drivers.

- ▶
- ▶
- ▶
- ▶

Code	Watt	Size(AxBmm)	Cut-out(mm)	Lumen(±5%)	N.W/pc(kgs)	Q'ty/CTN
JCL113B-6-25W	25W	Ø180x110	Ø150-160	2750lm	0.79	18PCS
JCL113B-6-35W	35W	Ø180x110	Ø150-160	3850lm	0.79	18PCS



# JDL170 Downlight

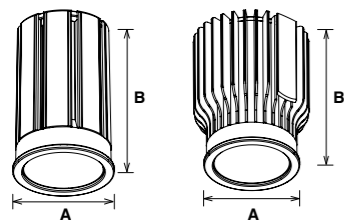

JDL170 downlight module adopts brand CITIZEN COB, lens (L) / reflector (R) and AL6063 aluminum heatsink. Various frames are selectable for different applications: round/ square, fixed/ rotatable, symmetric/ asymmetric, flat/ deep, oval hole/ circular hole frame. External driver is exchangeable through quick connector among non-dimmable driver, Triac dimmable, 0-10V and DALI dimmable drivers.

- ▶ 36° 60° IP20
- ▶ DIM DALI 0-10V
- ▶ AC 220-240V PF≥0.9 CRI≥80 CRI≥90 CRI≥97
- ▶ RoHS CE



Code	Watt	Size(AxBxCmm)	Cut-out(mm)	Lumen(±5%)	N.W/pc(kgs)	Q'ty/CTN
JDL170-10W	10W	Ø50x61	Trim	1000lm	0.17	100PCS
JDL170-13W	13W	Ø50x61	Trim	1490lm	0.17	100PCS
JDL170-18W	18W	Ø50x81	Trim	2130lm	0.25	50PCS
DL170-75-A	Trim	Ø85x46.8x75	Ø75-80	Trim	0.08	100PCS
JDL170-90-A	Trim	Ø100x45.8x90	Ø90-95	Trim	0.09	100PCS
JDL170-100-A	Trim	110x35x95	95-100	Trim	0.16	80PCS
JDL170-90-B	Trim	Ø100x64x90	Ø90-95	Trim	0.10	100PCS
JDL170-75-B1	Trim	Ø85x34.5x70	Ø70-80	Trim	0.11	100PCS
JDL170-75-B2	Trim	Ø85x34.5x70	Ø70-80	Trim	0.11	100PCS
JDL170-75-C	Trim	Ø90x24.8x70	Ø70-80	Trim	0.07	100PCS
JDL170-90-D	Trim	Ø110x32x90	Ø90-95	Trim	0.11	100PCS
JDL170-90-E	Trim	100x50x90	90-95	Trim	0.12	100PCS

CCT 2700K 3000K 4000K 5000K Trim White Black Silver

## JDL170 DIY module

Technical drawings for each assembly:

- JDL170-75-A
- JDL170-90-A
- JDL170-100-A
- JDL170-90-B
- JDL170-75-B1
- JDL170-75-B2
- JDL170-75-C
- JDL170-90-D
- JDL170-90-E



# JDL206 Downlight

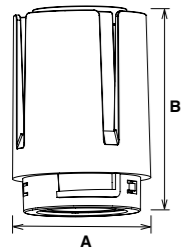

JDL206 downlight module adopts brand CITIZEN COB, lens and AL6063 aluminum heatsink. Fixed and rotatable frames are optional. External driver is exchangeable through quick connector among non-dimmable driver, Triac dimmable, 0-10V and DALI dimmable drivers.

- ▶ 36° 60° IP20
- ▶ DIM
- ▶ AC 220-240V PF≥0.9 CRI≥80 CRI≥90 CRI≥97
- ▶ RoHS CE

Code	Watt	Size(AxBxCmm)	Cut-out(mm)	Lumen(±5%)	N.W/pc(kgs)	Q'ty/CTN
JDL206-10W	10W	Ø49x72	Trim	850lm	0.16	30PCS
JDL206-20W	20W	Ø66x91	Trim	2300lm	0.35	20PCS
JDL206-25W	25W	Ø87x105	Trim	2700lm	0.56	20PCS
JDL206-35W	35W	Ø102x104	Trim	3450lm	0.74	20PCS
JDL206-3A	Trim	Ø100x40x83	Ø85-90	Trim	0.17	60PCS
JDL206-3B	Trim	Ø100x53x83	Ø85-90	Trim	0.16	60PCS
JDL206-4A	Trim	Ø140x53x115	Ø120-130	Trim	0.29	40PCS
JDL206-4B	Trim	Ø140x71x115	Ø120-130	Trim	0.32	40PCS
JDL206-5A	Trim	Ø160x71x140	Ø145-150	Trim	0.41	20PCS
JDL206-5B	Trim	Ø160x84.5x140	Ø145-150	Trim	0.40	20PCS

CCT — 2700K 3000K 4000K 5000K

Trim — White Black

## JDL206 DIY module



# JCL103 Downlight

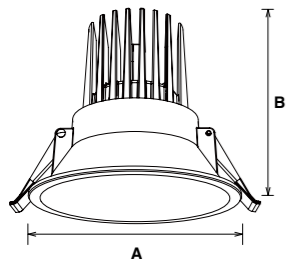

JCL103 fixed downlight adopts brand CREE COB, reflector and ADC12 aluminum heatsink. Deep cone design creates low UGR. External driver is exchangeable through quick connector among non-dimmable driver, Triac dimmable, 0-10V and DALI dimmable drivers.

- ▶ 60° IP20
- ▶ DIM DALI 0-10V
- ▶ AC 200-240V PF≥0.9 CRI≥80 CRI≥90 CRI≥97
- ▶ SAA RoHS CE

Code	Watt	Size(AxBmm)	Cut-out(mm)	Lumen(±5%)	N.W/pc(kgs)	Q'ty/CTN
JCL103-3-12W	12W	Ø100x90.6	Ø90-95	1010lm	0.40	24PCS
JCL103-3-12W-D	12W	Ø100x90.6	Ø90-95	980lm	0.40	24PCS

CCT — 3000K 4000K 5000K 5700K

Trim — White Black



# JCL103B Downlight

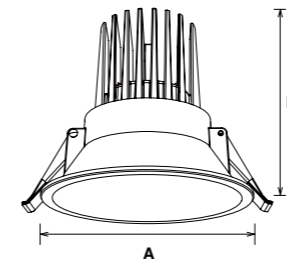

JCL103B fixed downlight adopts high efficiency SMD LED chips, PMMA lens and ADC12 aluminum heatsink. Deep cone design creates low UGR. External driver is exchangeable through quick connector among non-dimmable driver, Triac dimmable, 0-10V and DALI dimmable drivers.

- ▶ 60° IP54
- ▶ DIM DALI 0-10V
- ▶ AC 200-240V PF≥0.9 CRI≥80 CRI≥90 CRI≥97
- ▶ SAA RoHS CE

Code	Watt	Size(AxBmm)	Cut-out(mm)	Lumen(±5%)	N.W/pc(kgs)	Q'ty/CTN
JCL103B-2.5-8W	8W	Ø80x100	Ø70-75	720lm	0.38	24PCS
JCL103B-2.5-10W	10W	Ø80x100	Ø70-75	900lm	0.38	24PCS
JCL103B-3-10W	10W	Ø100x90.6	Ø90-95	960lm	0.40	24PCS
JCL103B-3-12W	12W	Ø100x90.6	Ø90-95	1140lm	0.40	24PCS

CCT — 3000K 4000K 5000K 5700K

Trim — White Black



# JDL201 Downlight

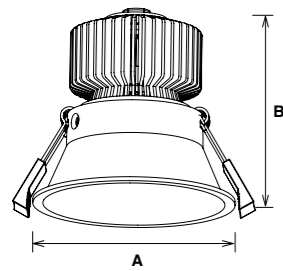

JDL201 downlight adopts brand CITIZEN COB, reflector and AL6063 aluminum heatsink. Deep cone design creates low UGR<19. Fixed or rotatable optional. External driver is exchangeable through quick connector among non-dimmable driver, Triac dimmable, 0-10V and DALI dimmable drivers.

- ▶ 36° IP40 UGR<19
  - ▶ DIM DALI 0-10V
  - ▶ AC 200-240V PF≥0.9 CRI≥80 CRI≥90 CRI≥97
  - ▶
- 

Code	Watt	Size(AxBmm)	Cut-out(mm)	Lumen(±5%)	N.W/pc(kgs)	Q'ty/CTN
JDL201A-2.5-10W	10W	Ø80x87	Ø75	910lm	0.26	36PCS
JDL201B-2.5-10W	10W	Ø85x81	Ø75	910lm	0.27	36PCS
JDL201-3-13W	13W	Ø100x94	Ø90	1170lm	0.32	24PCS
JDL201-3.5-13W	13W	Ø105x145	Ø100	1100lm	0.38	24PCS

CCT ——— 2700K 3000K 4000K 5000K

Trim ——— White Black

# ANTI GLARE DESIGN rotcefler peed htiw ( UGR<19 )







# JCL117 & JCL118 Downlight

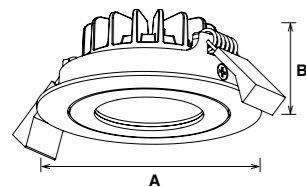

JCL117 & JCL118 slimline rotatable downlight adopts curve/ flat frame and exchangeable module, using brand CITIZEN COB, reflector (A) / lens (B) and ADC12 aluminum heatsink. External driver is exchangeable through quick connector between non-dimmable driver and Triac dimmable driver. Loop in/ loop out terminal makes convenient installation.

- ▶ 24° 36° 45° 60°
- ▶ IP54
- ▶
- ▶ AC 200-240V
- ▶ PF ≥ 0.9
- ▶ CRI ≥ 80
- ▶ CRI ≥ 90
- ▶ CRI ≥ 97
- ▶ RoHS
- ▶ CE

Code	Watt	Size(AxBmm)	Cut-out(mm)	Lumen(±5%)	N.W/pc(kgs)	Q'ty/CTN
JCL117A-2.5-6W	6W	Ø80x35	Ø68-75	530lm	0.19	48PCS
JCL117B-2.5-6W	6W	Ø80x35	Ø68-75	500lm	0.19	48PCS
JCL117A-3-6W	6W	Ø95x49	Ø82-88	570lm	0.25	36PCS
JCL117B-3-6W	6W	Ø95x49	Ø82-88	530lm	0.28	36PCS
JCL117A-3-8W	8W	Ø95x49	Ø82-88	785lm	0.25	36PCS
JCL117B-3-8W	8W	Ø95x49	Ø82-88	765lm	0.28	36PCS
JCL117A-3-10W	10W	Ø95x49	Ø82-88	1000lm	0.25	36PCS
JCL117B-3-10W	10W	Ø95x49	Ø82-88	970lm	0.28	36PCS
JCL118A-2.5-6W	6W	Ø80x33	Ø68-75	530lm	0.19	48PCS
JCL118B-2.5-6W	6W	Ø80x33	Ø68-75	500lm	0.19	48PCS
JCL118A-3-6W	6W	Ø95x44	Ø82-88	570lm	0.25	36PCS
JCL118B-3-6W	6W	Ø95x44	Ø82-88	530lm	0.27	36PCS
JCL118A-3-8W	8W	Ø95x44	Ø82-88	785lm	0.25	36PCS
JCL118B-3-8W	8W	Ø95x44	Ø82-88	765lm	0.27	36PCS
JCL118A-3-10W	10W	Ø95x44	Ø82-88	1000lm	0.25	36PCS
JCL118B-3-10W	10W	Ø95x44	Ø82-88	970lm	0.27	36PCS

CCT — 2700K 3000K 4000K 5000K

Trim — White Black Silver Nickel Brushed

## JCL117 & JCL118 DIY module

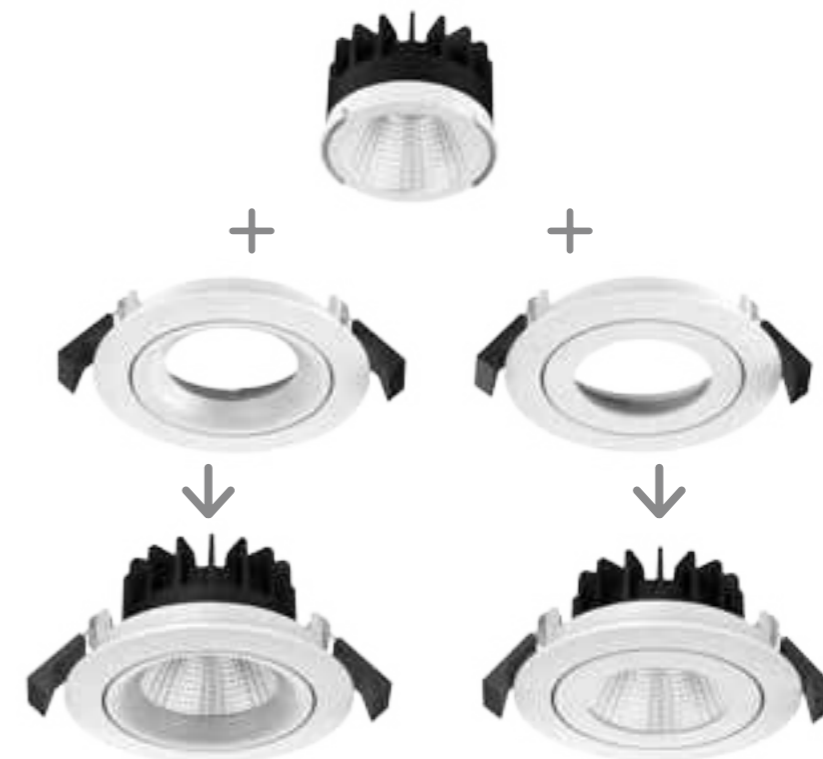

JCL117A

JCL118A



JCL117B

JCL118B



## JCL102 Downlight

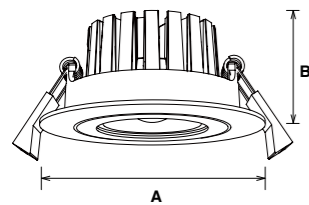

JCL102 slimline IP65 rotatable downlight adopts brand CREE COB, anti-glare lens and ADC12 aluminum heatsink. External driver is exchangeable through quick connector between non-dimmable driver and Triac dimmable driver.

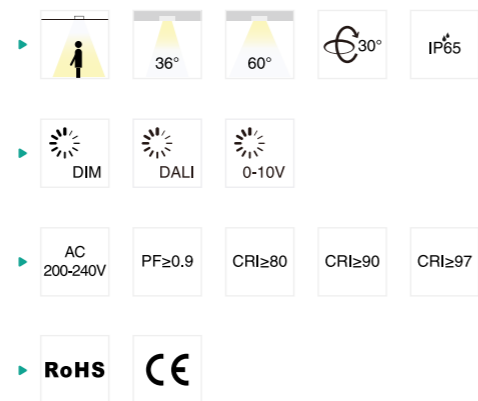

Code	Watt	Size(AxBmm)	Cut-out(mm)	Lumen(±5%)	N.W/pc(kgs)	Q'ty/CTN
JCL102A-2.5-5W	5W	Ø80x30	Ø68-72	530lm	0.24	50PCS
JCL102A-2.5-8W	8W	Ø80x30	Ø68-72	815lm	0.24	50PCS
JCL102B-2.5-10W	10W	Ø90x39.3	Ø75-80	1000lm	0.25	50PCS
JCL102-3-10W	10W	Ø110x49.5	Ø90-95	1000lm	0.40	30PCS
JCL102-3-13W	13W	Ø110x49.5	Ø90-95	1350lm	0.40	30PCS

CCT — 2700K 3000K 4000K 5000K Trim — White Black Silver Nickel Brushed

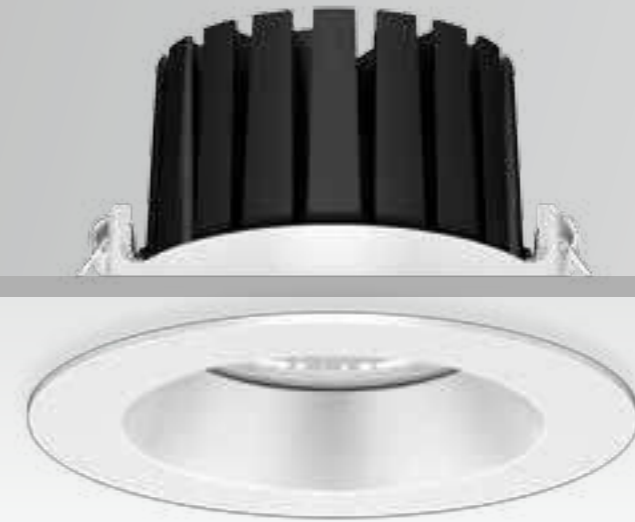

## JDL103 Downlight

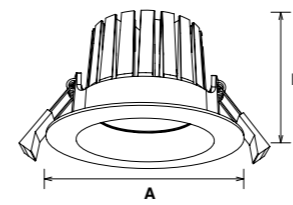

JDL103 slimline IP65 fixed downlight adopts brand CREE COB, anti-glare lens and ADC12 aluminum heatsink. External driver is exchangeable through quick connector between non-dimmable driver and Triac dimmable driver.

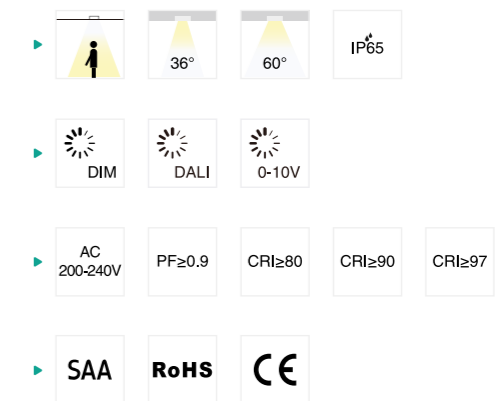

Code	Watt	Size(AxBmm)	Cut-out(mm)	Lumen(±5%)	N.W/pc(kgs)	Q'ty/CTN
JDL103A-2.5-5W	5W	Ø80x40	Ø68-72	530lm	0.18	50PCS
JDL103A-2.5-8W	8W	Ø80x40	Ø68-72	815lm	0.18	50PCS
JDL103B-2.5-10W	10W	Ø90x49.4	Ø75-80	1000lm	0.27	50PCS
JDL103-3-10W	10W	Ø110x64.3	Ø90-95	1000lm	0.45	30PCS
JDL103-3-13W	13W	Ø110x64.3	Ø90-95	1350lm	0.45	30PCS

CCT — 2700K 3000K 4000K 5000K Trim — White Black Silver Nickel Brushed

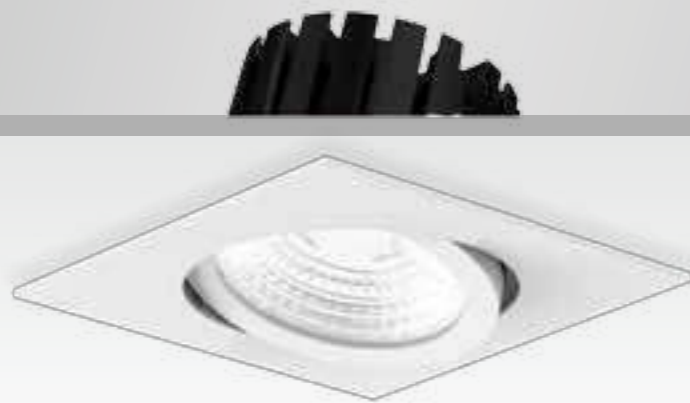

## JCL104 Downlight

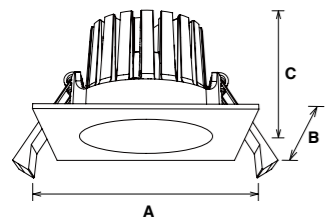

JCL104 square slimline IP65 rotatable downlight adopts brand CREE COB, anti-glare lens and ADC12 aluminum heatsink. External driver is exchangeable through quick connector between non-dimmable driver and Triac dimmable driver.

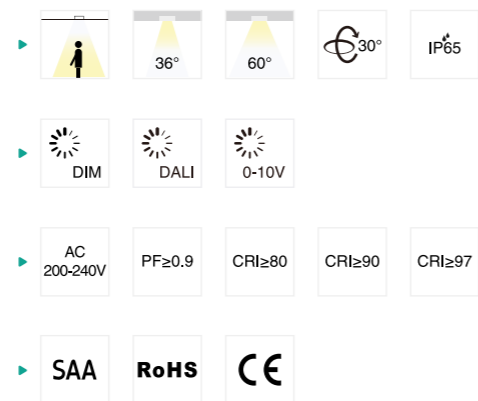

Code	Watt	Size(AxBxCmm)	Cut-out(mm)	Lumen(±5%)	N.W/pc(kgs)	Q'ty/CTN
JCL104A-2.5-5W	5W	80x80x30	Ø68-72	530lm	0.22	50PCS
JCL104A-2.5-8W	8W	80x80x30	Ø68-72	815lm	0.22	50PCS
JCL104B-2.5-10W	10W	90x90x39	Ø75-80	1000lm	0.26	50PCS
JCL104-3-10W	10W	110x110x50	Ø90-95	1000lm	0.35	30PCS
JCL104-3-13W	13W	110x110x50	Ø90-95	1350lm	0.35	30PCS

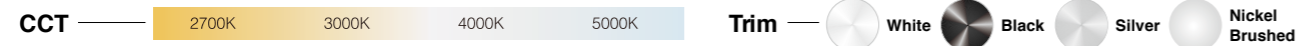

## JDL104 Downlight

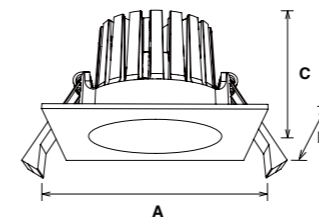

JDL104 square slimline IP65 fixed downlight adopts brand CREE COB, anti-glare lens and ADC12 aluminum heatsink. External driver is exchangeable through quick connector between non-dimmable driver and Triac dimmable driver.

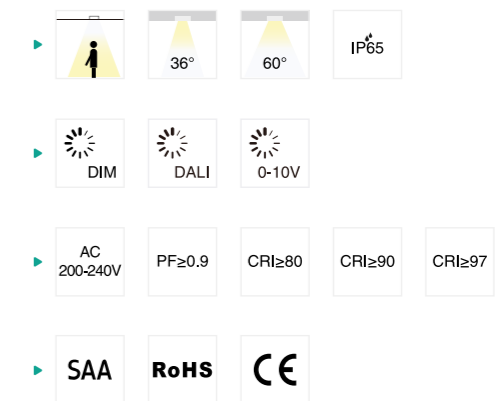

Code	Watt	Size(AxBxCmm)	Cut-out(mm)	Lumen(±5%)	N.W/pc(kgs)	Q'ty/CTN
JDL104A-2.5-5W	5W	80x80x40	Ø68-72	530lm	0.22	50PCS
JDL104A-2.5-8W	8W	80x80x40	Ø68-72	815lm	0.22	50PCS
JDL104B-2.5-10W	10W	90x90x49	Ø75-80	1000lm	0.28	50PCS
JDL104-3-10W	10W	110x110x64	Ø90-95	1000lm	0.39	30PCS
JDL104-3-13W	13W	110x110x64	Ø90-95	1350lm	0.39	30PCS

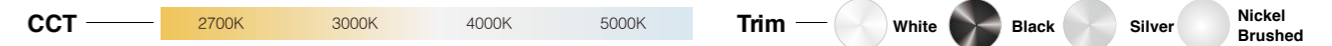



## JDL63 Downlight

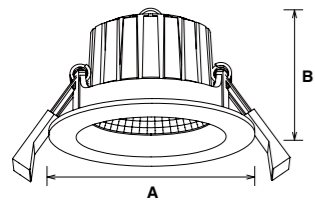

JDL63 Mini downlight is with standard cutout size of 70mm. 24°/36°/60° beam angle provided, CRI80/90/97 optional, it is applicable for various lighting effect. Waterproof structural design, IP54 protection grade, ideally for damp locations.

- ▶ 24° 36° 60°
- ▶ IP54
- ▶ DIM DALI 0-10V DIM TO WARM
- ▶ AC 200-240V PF≥0.9 CRI≥80 CRI≥90 CRI≥97
- ▶ SAA RoHS CE

Code	Watt	Size(AxBmm)	Cut-out(mm)	Lumen(±5%)	N.W/pc(kgs)	Q'ty/CTN
JDL63-2.5-5W	5W	Ø80x55	Ø68-74	450lm	0.28	48PCS
JDL63-2.5-8W	8W	Ø80x55	Ø68-74	590lm	0.28	48PCS
JDL63-2.5-8W-P	8W	Ø80x55	Ø68-74	400lm	0.28	48PCS

CCT — 2700K 3000K 4000K 5000K Trim — White Black Silver Nickel Brushed



## JDL64 Downlight

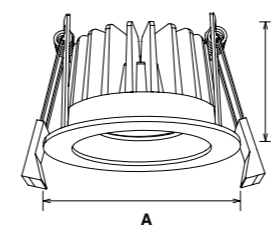

JDL64 downlight adopts super high lumen COB and excellent light transmittance prismatic lens. 36°/60° beam angle are available. Cutout 70-75mm, an ideal replacement for traditional lamps.

- ▶ 36° 60°
- ▶ IP40
- ▶ DIM DALI 0-10V
- ▶ AC 200-240V PF≥0.9 CRI≥80 CRI≥90 CRI≥97
- ▶ SAA RoHS CE

Code	Watt	Size(AxBmm)	Cut-out(mm)	Lumen(±5%)	N.W/pc(kgs)	Q'ty/CTN
JDL64-2.5-10W	10W	Ø82x58	Ø70-75	1010lm	0.25	48PCS

CCT — 2700K 3000K 4000K 5000K Trim — White Black Silver Nickel Brushed

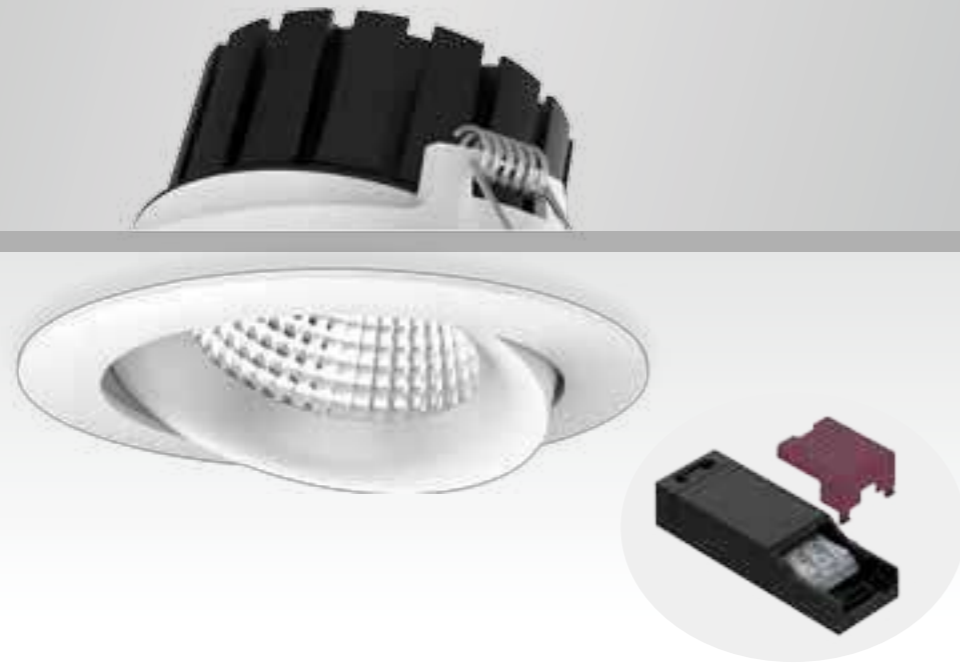

## JCL76 Downlight

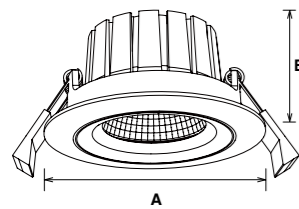

JCL76 Mini down light JCL76 is specially designed for European market with standard cutout size of 83mm. 15°/24°/36°/60° beam angle are provided. Combined of COB LED and PC reflector. 25 degree flexible rotary head makes installation easier and better. CRI80/90/97 optional, dim to warm is available.

- ▶ 15° 24° 36°
- ▶ 60° 25° IP54
- ▶ DIM DALI 0-10V DIM TO WARM
- ▶ AC 200-240V PF ≥ 0.9 CRI ≥ 80 CRI ≥ 90 CRI ≥ 97
- ▶ RoHS CE

Code	Watt	Size(AxBmm)	Cut-out(mm)	Lumen(±5%)	N.W/pc(kgs)	Q'ty/CTN
JCL76-3-8W	8W	Ø95x55	Ø82-88	570lm	0.34	48PCS
JCL76-3-10W	10W	Ø95x55	Ø82-88	770lm	0.34	48PCS
JCL76-3-10W-P	10W	Ø95x55	Ø82-88	450lm	0.34	48PCS

CCT — 2700K 3000K 4000K 5000K Trim — White Black Silver Nickel Brushed



## JCL78 Downlight

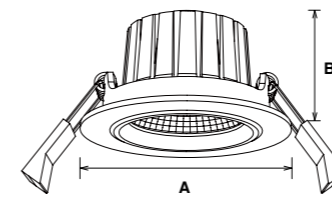

JCL78 Mini down light JCL78 with 24°/36°/60° beam angle is applicable for various lighting effects. With IP54 waterproof design, it is the ideal for damp locations. 25 degree flexible rotary head makes installation easier and better. CRI80/90/97 optional, dim to warm is available.

- ▶ 24° 36° 60° 25° IP54
- ▶ DIM DALI 0-10V DIM TO WARM
- ▶ AC 200-240V PF ≥ 0.9 CRI ≥ 80 CRI ≥ 90 CRI ≥ 97
- ▶ RoHS CE

Code	Watt	Size(AxBmm)	Cut-out(mm)	Lumen(±5%)	N.W/pc(kgs)	Q'ty/CTN
JCL78-2.5-5W	5W	Ø80x50	Ø68-74	450lm	0.27	48PCS
JCL78-2.5-8W	8W	Ø80x50	Ø68-74	600lm	0.27	48PCS
JCL78-2.5-8W-P	8W	Ø80x50	Ø68-74	400lm	0.27	48PCS

CCT — 2700K 3000K 4000K 5000K Trim — White Black Silver Nickel Brushed



# JCL77 Downlight

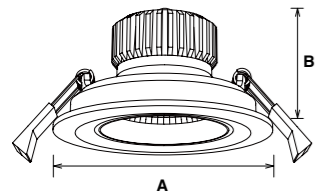

Patent mini down light JCL77 is specially designed for European market. It adopts high-reflectivity PC reflector; adjustable lighting direction provides all possible lighting effects, 360 degree rotates horizontally and 25 degree rotates vertically, multiple beam angle options: 15°/24°/36°/60°.

- ▶ 15° 24° 36°
- ▶ 60° 360° 25° IP40
- ▶ DIM DALI 0-10V DIM TO WARM
- ▶ AC 200-240V PF $\geq$ 0.9 CRI $\geq$ 80 CRI $\geq$ 90 CRI $\geq$ 97
- ▶ RoHS CE

Code	Watt	Size(AxBmm)	Cut-out(mm)	Lumen(±5%)	N.W/pc(kgs)	Q'ty/CTN
JCL77-3-10W	10W	Ø100x58	Ø85-90	770lm	0.34	48PCS
JCL77-3-10W-P	10W	Ø100x58	Ø85-90	450lm	0.34	48PCS

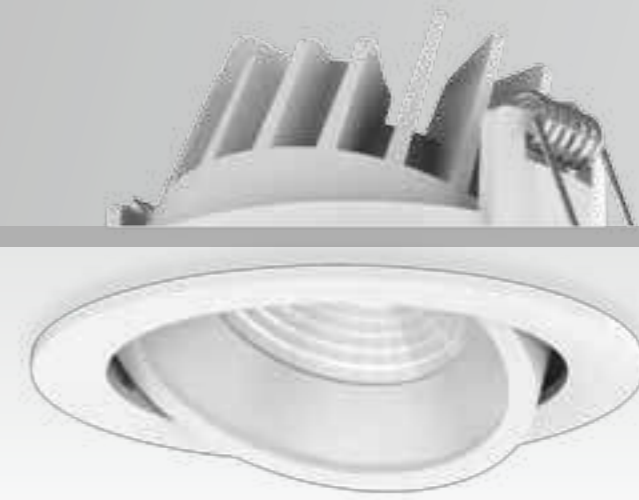

# JCL79 Downlight

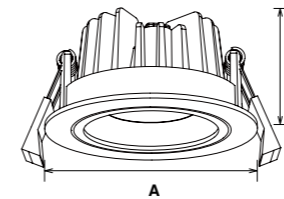

Mini down light JCL79 achieves 100lm/W high efficiency with super high lumen COB and excellent light transmittance prismatic lens. It has 22° vertically adjustable lighting directions. External driver makes easier maintenance.

- ▶ 36° 60° 22° IP40
- ▶ DIM DALI 0-10V
- ▶ AC 200-240V PF $\geq$ 0.85 PF $\geq$ 0.9 CRI $\geq$ 80 CRI $\geq$ 90 CRI $\geq$ 97
- ▶ SAA RoHS CE

Code	Watt	Size(AxBmm)	Cut-out(mm)	Lumen(±5%)	N.W/pc(kgs)	Q'ty/CTN
JCL79-2.5-10W	10W	Ø90x46	Ø84	1010lm	0.26	48PCS



## JCL79A/B Downlight

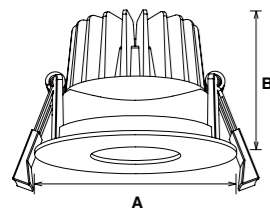

This Mini down light achieves 100lm/W high efficiency with super high lumen COB and excellent light transmittance prismatic lens. It has adjustable head for different lighting directions. External driver makes easier maintenance.

- ▶ 36° 5° IP40
- ▶ DIM DALI 0-10V
- ▶ AC 200-240V PF≥0.5 PF≥0.9 CRI≥80 CRI≥90 CRI≥97
- ▶ SAA RoHS CE

Code	Watt	Size(AxBmm)	Cut-out(mm)	Lumen(±5%)	N.W/pc(kgs)	Q'ty/CTN
JCL79A-2.5-10W	10W	Ø91.5x61	Ø84	800lm	0.26	48PCS
JCL79B-2.5-10W	10W	Ø91.5x61	Ø84	800lm	0.26	48PCS

CCT — 2700K — 3000K — 4000K — 5000K

Trim — White Black



## JCL79C Downlight

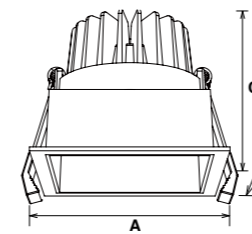

This Mini down light achieves 100lm/W high efficiency with super high lumen COB and excellent light transmittance prismatic lens. It has 22° vertically adjustable lighting directions. External driver makes easier maintenance.

- ▶ 36° 60° 22° IP40
- ▶ DIM DALI 0-10V
- ▶ AC 200-240V PF≥0.5 PF≥0.9 CRI≥80 CRI≥90 CRI≥97
- ▶ SAA RoHS CE

Code	Watt	Size(AxBxCmm)	Cut-out(mm)	Lumen(±5%)	N.W/pc(kgs)	Q'ty/CTN
JCL79C-2.5-10W	10W	90x90x76	84x84	1020lm	0.30	48PCS

CCT — 2700K — 3000K — 4000K — 5000K

Trim — White Black



## JDL123 Downlight

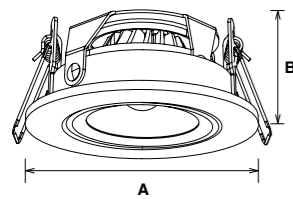

Mini gyro downlight JDL123, adopts high lumen COB LED, high energy efficacy and high CRI and tight focus. DL123 downlight is ideally suitable for a variety of applications. With the adjustable and rotatable luminaire, it perfectly meets the demands of different lighting angle.

- ▶ 36° 60° IP20
- ▶ DIM
- ▶ AC 200-240V PF ≥ 0.5 PF ≥ 0.9 CRI ≥ 80 CRI ≥ 90 CRI ≥ 97
- ▶ RoHS CE

Code	Watt	Size(AxBmm)	Cut-out(mm)	Lumen(±5%)	N.W/pc(kgs)	Q'ty/CTN
JDL123-2.5-6W	6W	Ø80x37	Ø72-75	615lm	0.21	40PCS

CCT — 2700K 3000K 4000K 5000K

Trim — White Black



## JDL124 Downlight

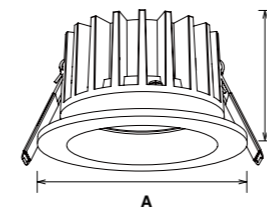

JDL124 down light with smart optical design combines COB LED and PC reflector. It creates the most comfortable lighting environment. With waterproof IP65 structural design, it is the ideal for damp locations. Aluminum profile provides excellent thermal dissipation.

- ▶ 36° IP65 IP20
- ▶ DIM
- ▶ AC 200-240V PF ≥ 0.5 PF ≥ 0.9 CRI ≥ 80
- ▶ RoHS CE

Code	Watt	Size(AxBmm)	Cut-out(mm)	Lumen(±5%)	N.W/pc(kgs)	Q'ty/CTN
JDL124-2.5-7W	7W	Ø90x50	Ø74-80	600lm	0.25	50PCS

CCT — 2700K 3000K 4000K 5000K

Trim — White Black





## JDL88 Downlight

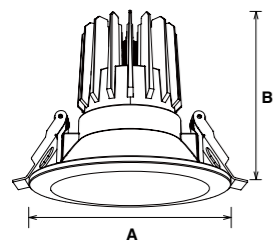

JDL88 down light is unique designed with deep reflector. ADC12 aluminum profile provides excellent thermal dissipation. Isolated driver solution both in dimmable and non-dimmable version achieved a great dimming compatibility with worldwide brand dimmers.

- ▶ 24° 60° IP20
- ▶ DIM DALI 0-10V
- ▶ AC 200-240V PF<sub>≥</sub>0.9 CRI<sub>≥</sub>80 CRI<sub>≥</sub>90 CRI<sub>≥</sub>97
- ▶ SAA RoHS CE

Code	Watt	Size(AxBmm)	Cut-out(mm)	Lumen(±5%)	N.W/pc(kgs)	Q'ty/CTN
JDL88-2.5-10W	10W	Ø85x89	Ø68-75	860lm	0.27	24PCS
JDL88-2.5-13W	13W	Ø85x89	Ø68-75	1190lm	0.27	24PCS
JDL88-3-13W	13W	Ø110x98	Ø90-95	1190lm	0.35	24PCS

CCT — 2700K 3000K 4000K 5000K

Trim — White Black



## JDL202 Cabinet light

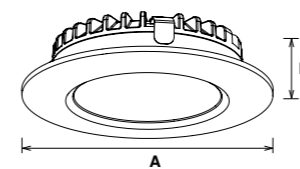

JDL202 LED under cabinet light with ADC12 aluminum light body, providing good heat dissipation. 70 degree beam angle with lens. Adopting 12V constant voltage driver, 3-way and 6-way distributor for options.

- ▶ 70° IP54
  - ▶ AC 100-240V PF<sub>≥</sub>0.5 CRI<sub>≥</sub>80
  - ▶ RoHS CE
- 

Code	Watt	Size(AxBmm)	Cut-out(mm)	Lumen(±5%)	N.W/pc(kgs)	Q'ty/CTN
JDL202-3.5W	3.5W	Ø70x17	Ø58	300lm	0.08*3	30*3PCS
driver with 3-way distributor	/	/	/	/	0.13	90PCS
driver with 6-way distributor	/	/	/	/	0.14	90PCS

CCT — 3000K 4000K 5000K 5700K

Finish — White Black



## JDL278 Downlight

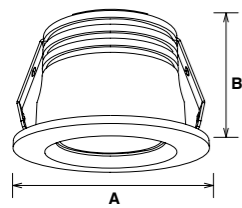

JDL278 minimises and recessed spot design makes the luminaire glare free, adopting high quality brand COB as symmetric lighting, flicker free external driver. CRI>80 or CRI>90 for options. AL6063 die-casting lamp body provides great heat dissipation. Several beam angles available, such as 15°/24°/32°/36°. Attractive as a decor light recessed into window nooks and furniture.

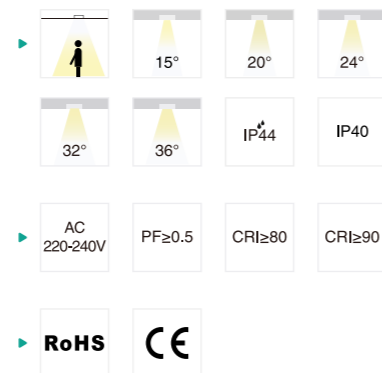

Code	Watt	Size(AxBmm)	Cut-out(mm)	Lumen(±5%)	N.W/pc(kgs)	Q'ty/CTN
JDL278-1-1.5W	1.5W	Ø30x24	Ø25	110lm	0.04	60PCS
JDL278-1.4-3W	3W	Ø40x24	Ø35	210lm	0.06	60PCS

CCT — 2700K — 3000K — 4000K

Trim — White — Black

## JCL138 Downlight

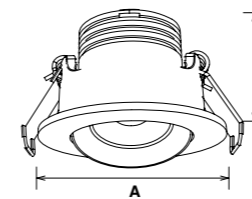

JCL138 minimises and recessed spot design makes the luminaire glare free, With djustable head version (Tilting angle is ±20°). Flicker free external driver, CRI>80 or CRI>90 for options. AL6063 die-casting lamp body provides great heat dissipation. Several beam angles available, such as 15°/20°/24°/32°. Attractive as a decor light recessed into window nooks and furniture.



Code	Watt	Size(AxBmm)	Cut-out(mm)	Lumen(±5%)	N.W/pc(kgs)	Q'ty/CTN
JCL138-1.8-3W	3W	Ø50x30	Ø45	210lm	0.09	60PCS

CCT — 2700K — 3000K — 4000K

Trim — White — Black



## JCL140 Downlight

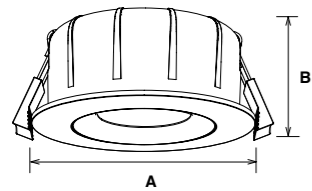

This downlight is a gyro design, it has a rear cover which is suitable for covering with insulation material directly. Adopt high lumen COB light source, ADC12 aluminum housing provides a great heat dissipation. 15°/24°/36°/60° beam angle provided, available for Dim to warm 2000-3000K. Lamp with female plug, driver with male plug, which make an easier installation.

- ▶ 15° 24° 36° 60°
- ▶ 360° 23°
- ▶ IP54 DIM TO WARM
- ▶ DIM DALI 0-10V
- ▶ AC 200-240V PF≥0.85 CRI≥80 CRI≥90 CRI≥97
- ▶ RoHS CE

Code	Watt	Size(AxBmm)	Cut-out(mm)	Lumen(±5%)	N.W/pc(kgs)	Q'ty/CTN
JCL140-2.5-8W	8W	Ø96x44	Ø83	850lm	0.18	40PCS

CCT — 2700K 3000K 4000K 5000K Trim — White Black Silver Nickel Brushed



## JCL128 Downlight

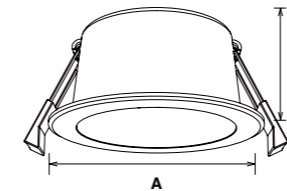

JCL128 LED downlight is gyro design which is suitable for covering with insulation material directly. It adopts high lumen COB light source, ADC12 aluminum housing provides a great heat dissipation. Different lighting angle with tilted 23° in all directions (360°) and Dim-to-Warm version (2000K~3000K) are available.

- ▶ 12° 24° 36° 60° IP20
- ▶ DIM DALI 0-10V DIM TO WARM
- ▶ AC 200-240V PF≥0.85 CRI≥80 CRI≥90 CRI≥97
- ▶ RoHS CE

Code	Watt	Size(AxBmm)	Cut-out(mm)	Lumen(±5%)	N.W/pc(kgs)	Q'ty/CTN
JCL128-2.5-8W-D	8W	Ø95x50	Ø83-86	864lm	0.30	40PCS
JCL128-2.5-8W-DW	8W	Ø95x50	Ø83-86	445lm	0.30	40PCS

CCT — 2700K 3000K 4000K 5000K Trim — White Black Silver Nickel Brushed



## JDL263 Downlight

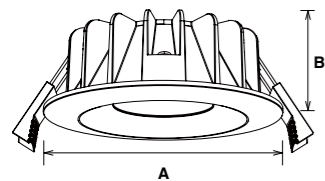

This is a fixed mini downlight, suitable for covering with insulation material directly. Adopt high lumen COB light source, ADC12 aluminum housing provides a great heat dissipation. 15°/24°/36°/60° beam angle provided, available for Dim to warm 2000-3000K. Lamp with female plug, driver with male plug, which makes an easier installation.

- ▶ 15° 24° 36° 60°
- ▶ IP54
- ▶
- ▶
- ▶

Code	Watt	Size(AxBmm)	Cut-out(mm)	Lumen(±5%)	N.W/pc(kgs)	Q'ty/CTN
JDL263-2.5-8W	8W	Ø95x35	Ø83	850lm	0.17	40PCS

CCT — 3000K 4000K 5000K 5700K Trim — White Black Silver Nickel Brushed

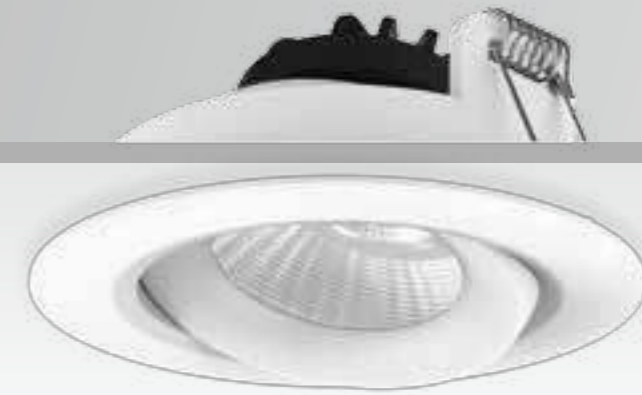

## JCL130 Downlight

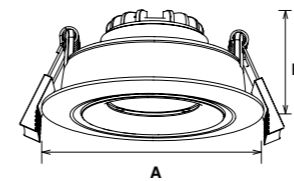

This downlight is a gyro design. Adopt high lumen COB light source, ADC12 aluminum housing provides a great heat dissipation. The luminaire is tilted 23° in all directions (360°), perfectly meet the demands of different lighting angle. Also available as Dim-to-Warm version (2000K~3000K).

- ▶ 15° 24° 36° 60°
- ▶ IP20
- ▶
- ▶
- ▶

Code	Watt	Size(AxBmm)	Cut-out(mm)	Lumen(±5%)	N.W/pc(kgs)	Q'ty/CTN
JCL130-2.5-8W-D	8W	Ø95x45mm	Ø83-86	814lm	0.28	40PCS
JCL130-2.5-8W-DW	8W	Ø95x45mm	Ø83-86	497lm	0.28	40PCS

CCT — 2700K 3000K 4000K 5000K Trim — White Black Silver Nickel Brushed



# JDL259 Downlight

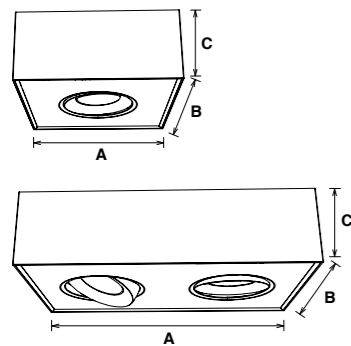

JDL259 LED surface mounted downlight with flicker free built-in driver design, adopting Edison COB and aluminium lamp body which provides good heat dissipation. Dim-to-Warm version (2000K~3000K) is available.

- ▶ 15° 24° 30° 36° 60°
- ▶ IP20
- ▶ DIM
- ▶ AC 200-240V PF≥0.9 CRI≥90 CRI≥97
- ▶ RoHS CE

Code	Watt	Size(AxBxCmm)	Cut-out(mm)	Lumen(±5%)	N.W/pc(kgs)	Q'ty/CTN
JDL259-8W-D	8W	135x135x60	/	700lm	0.58	24PCS
JDL259-8W-DW	8W	135x135x60	/	440lm	0.58	24PCS
JDL259-16W-D	16W	224x135x60	/	1600lm	0.91	12PCS
JDL259-16W-DW	16W	224x135x60	/	950lm	0.91	12PCS

CCT — 2700K 3000K 4000K 5000K

Finish — White Black Silver Nickel Brushed





# JRD01 Downlight

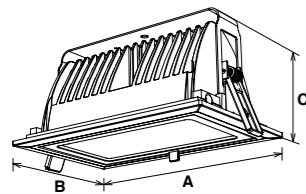

JRD01 rectangular downlight is unique designed with COB high power LED chip. IP65 waterproof can be used in wider applications, especial for damp location. AL6063 Aluminum profile provides excellent thermal dissipation. Isolated external driver solution achieves stable working performance.

- ▶ 120° 45°
- ▶ DIM DALI 0-10V
- ▶ AC 100-240V PF≥0.9 CRI≥80
- ▶ SAA RoHS CE

Code	Watt	Size(AxBxCmm)	Cut-out(mm)	Lumen(±5%)	N.W/pc(kgs)	Q'ty/CTN
JRD01-35W	35W	235x145x117.4	220x130	3050lm	2.40	6PCS
JRD01-45W	45W	235x145x117.4	220x130	3850lm	2.40	6PCS



# JRD01-B Downlight

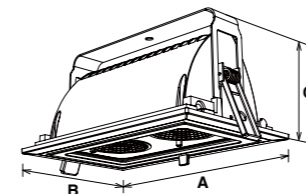

JRD01-B rectangular downlight is unique designed with 2 COB chips. IP65 waterproof can be used in wider applications, especial for damp location. AL6063 Aluminum profile provides excellent thermal dissipation. Isolated external driver solution achieves stable working performance.

- ▶ 45° 45°
- ▶ DIM DALI 0-10V
- ▶ AC 100-240V PF≥0.9 CRI≥80
- ▶ RoHS CE

Code	Watt	Size(AxBxCmm)	Cut-out(mm)	Lumen(±5%)	N.W/pc(kgs)	Q'ty/CTN
JRD01-B-35W	35W	235x145x117.4	220x130	2970lm	2.40	6PCS
JRD01-B-45W	45W	235x145x117.4	220x130	3900lm	2.40	6PCS



## JRD01-C Downlight

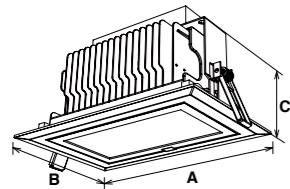

JRD01-C SMD Rectangular downlight achieves high lumen output, 90° wide beam angle. AL6063 Aluminum profile provides excellent thermal dissipation. External driver solution achieves stable working performance and easy maintenance. Tilt head provides various lighting direction for different applications. It is widely used for different commercial lighting situation.

- ▶ 90° IP20
- ▶ DIM DALI 0-10V SLIDE SWITCH 3 in 1
- ▶ AC 200-240V PF≥0.9 CRI≥80
- ▶ SAA RoHS CE

Code	Watt	Size(AxBxCmm)	Cut-out(mm)	Lumen(±5%)	N.W/pc(kgs)	Q'ty/CTN
JRD01-C-40W	40W	246x156x115	225x130	3950lm	2.30	4PCS
JRD01-C-60W	60W	246x156x115	225x130	5450lm	2.30	4PCS

CCT  3000K 4000K 5000K 5700K

Finish  White  Black



## JRD07A&B Downlight

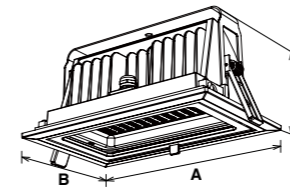

JRD07 LED is new commercial light series with external driver design. Type A is unique louver reflector design and type B woven glass design, both 2 types adopting high lumen SMD LED chip with uniform light output, ADC12 die casting aluminum provides an excellent thermal dissipation. IP65 waterproof and 70°vertically rotatable are available.

- ▶ 70° 110° IP65 IP20
- ▶ DIM DALI 0-10V SLIDE SWITCH 3 in 1
- ▶ AC 200-240V PF≥0.9 CRI≥80
- ▶ RoHS CE



Code	Watt	Size(AxBxCmm)	Cut-out(mm)	Lumen(±5%)	N.W/pc(kgs)	Q'ty/CTN
JRD07A-32W	32W	235x145x117.4	220x130	3150lm	1.77	6PCS
JRD07A-42W	42W	235x145x117.4	220x130	3900lm	1.77	6PCS
JRD07B-32W	32W	235x145x117.4	220x130	4200lm	1.77	6PCS
JRD07B-42W	42W	235x145x117.4	220x130	5100lm	1.77	6PCS

CCT  3000K 4000K 5000K 5700K

FINISH   Black



## JCL137 Downlight

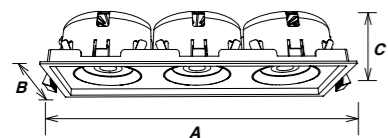

JCL137 LED commercial downlight series with external flicker free driver design, adopting brand Citizen COB, ADC12 aluminium lamp body provide great heat dissipation. 360° in horizontal and 23° in vertical and IP54 are available. White/Black/Silver/Nickel brushed 4 kinds of surface colors for options.

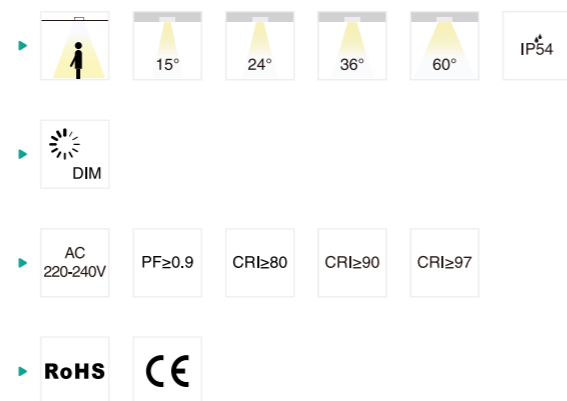

Code	Watt	Size(AxBxCmm)	Cut-out(mm)	Lumen(±5%)	N.W/pc(kgs)	Q'ty/CTN
JCL137-8W	8W	95x95x53	89x89	920lm	0.35	24PCS
JCL137-10W	10W	95x95x53	89x89	1100lm	0.35	24PCS
JCL137-14W	14W	175x95x53	69x89	1670lm	0.60	24PCS
JCL137-20W	20W	175x95x53	69x89	2230lm	0.60	24PCS
JCL137-24W	24W	255x95x53	249x89	2840lm	0.85	12PCS
JCL137-30W	30W	255x95x53	249x89	3320lm	0.85	12PCS

CCT — 2700K 3000K 4000K 5000K

Finish — White Black Silver Nickel Brushed



## JCL68 Downlight

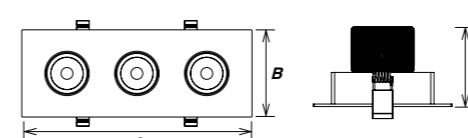

JCL68 square LED recessed commercial downlight adopts high-efficiency COB. It brings excellent lighting effect. Single head 10W, double heads 20W and triple heads 30W provide wider choices for you. Adjustable lighting direction offers various lighting orientation.

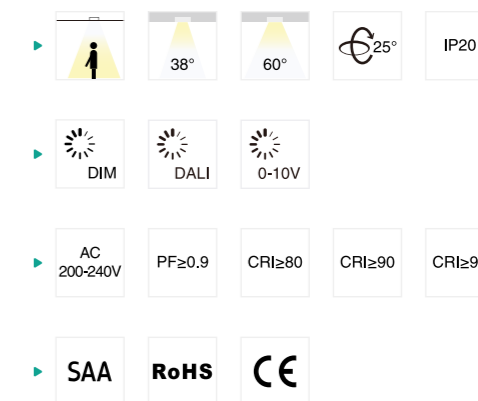

Code	Watt	Size(AxBxCmm)	Cut-out(mm)	Lumen(±5%)	N.W/pc(kgs)	Q'ty/CTN
JCL68-10W	10W	110x110x63	90-90	820lm	0.33	30PCS
JCL68-20W	20W	200x110x63	180-90	1650lm	0.60	20PCS
JCL68-30W	30W	290x110x63	270-90	2400lm	0.83	20PCS

CCT — 3000K 4000K 5000K 5700K

Finish — White Black





# JCL99 Downlight

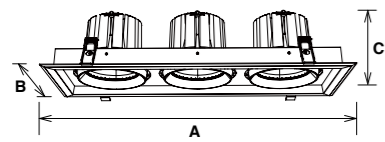

JCL99 downlight is a unique replaceable module design which makes an easier installation and maintenance. The drivers are sperated and external for replacement easily. It is an ideal design for commercial lighting.

- ▶ 15° 24° 36° 340° IP20
- ▶ DIM DALI 0-10V
- ▶ AC 200-240V PF $\geq$ 0.9 CRI $\geq$ 80 CRI $\geq$ 90 CRI $\geq$ 97
- ▶ SAA RoHS CE

Code	Watt	Size(AxBxCmm)	Cut-out(mm)	Lumen(±5%)	N.W/pc(kgs)	Q'ty/CTN
JCL99-30W	30W	175x175x110	160-160	3100lm	1.25	12PCS
JCL99-60W	60W	330x175x110	310-160	5800lm	2.25	6PCS
JCL99-90W	90W	475x175x110	455-160	8800lm	3.20	6PCS

CCT  2700K 3000K 4000K 5000K

Finish  White  Black



# JCL67 Downlight

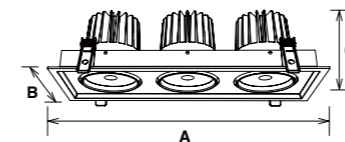

JCL67 square LED recessed commercial downlight adopts high-efficiency Citizen COB. It brings excellent lighting effect. Single head, double heads and triple heads provide wider choices for you. Adjustable lighting direction offers various lighting orientation.

- ▶ 60° 25° IP20
- ▶ DIM DALI 0-10V
- ▶ AC 200-240V PF $\geq$ 0.9 CRI $\geq$ 80 CRI $\geq$ 90 CRI $\geq$ 97
- ▶ SAA RoHS CE

Code	Watt	Size(AxBxCmm)	Cut-out(mm)	Lumen(±5%)	N.W/pc(kgs)	Q'ty/CTN
JCL67-30W	30W	175x175x135	160-160	3210lm	1.30	12PCS
JCL67-60W	60W	330x175x135	310-160	6420lm	2.60	6PCS
JCL67-90W	90W	475x175x135	455-160	9630lm	3.60	4PCS

CCT  2700K 3000K 4000K 5000K

Finish  White  Black



## JRD02 & JRD03 Downlight

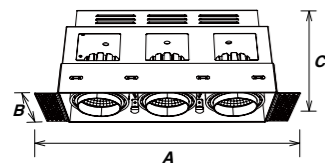

This frameless commercial downlight adopted brand CREE COB chip which offers a high lumen output. JRD02 JRD03 single head, double heads, triple heads provide a wider choice. Adjustable lighting direction offers various lighting orientation.

- ▶ 24° IP20
- ▶ AC 200-240V PF≥0.9 CRI≥80 CRI≥90 CRI≥97
- ▶ RoHS CE



Code	Watt	Size(AxBxCmm)	Cut-out(mm)	Lumen(±5%)	N.W/pc(kgs)	Q'ty/CTN
JRD02-8W	8W	155.5x83.5x134	86-86	550lm	1.30	12PCS
JRD02-16W	16W	235.5x83.5x134	167-86	1250lm	1.90	6PCS
JRD02-24W	24W	315.5x83.5x134	247-86	1700lm	2.50	6PCS
JRD03-12W	12W	185x113x154	116-116	980lm	1.70	12PCS
JRD03-24W	24W	294x113x154	228-116	2040lm	2.50	6PCS
JRD03-36W	36W	404x113x154	338-116	2700lm	3.10	6PCS



## JRD04 & JRD05 Downlight

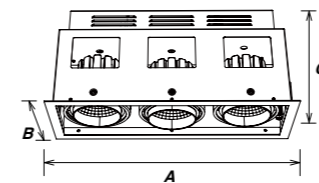

JRD04 JRD05 with brand CREE COB high power LED chip. Single head, double heads and triple heads provide a wider choice. Adjustable lighting direction offers various lighting orientation.

- ▶ 24° IP20
- ▶ AC 200-240V PF≥0.9 CRI≥80 CRI≥90 CRI≥97
- ▶ RoHS CE



Code	Watt	Size(AxBxCmm)	Cut-out(mm)	Lumen(±5%)	N.W/pc(kgs)	Q'ty/CTN
JRD04-8W	8W	100x100x135	85-85	550lm	1.10	12PCS
JRD04-16W	16W	180x100x135	165-85	1250lm	1.80	6PCS
JRD04-24W	24W	260x100x135	245-85	1700lm	2.40	6PCS
JRD05-12W	12W	130x130x155	115-115	980lm	1.60	12PCS
JRD05-24W	24W	239x130x155	224-115	2040lm	2.40	6PCS
JRD05-36W	36W	349x130x155	334-115	2700lm	3.00	6PCS



# JDL264 Downlight

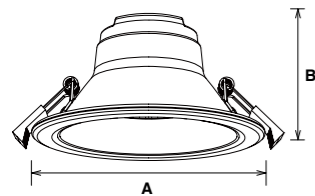

JDL264 LED downlight with anti-glare UGR<19 and external driver design. Adopting high lumen SMD light source 100lm/W, the scale PC shade and reflector make a uniform light output. AL1060 aluminum housing provides a great thermal management. Interchangeable CCT and IP54 in front are available.

- 60°
- IP54
- IP20
- UGR<19
- DIM
- DALI
- 0-10V
- SLIDE SWITCH 3 in 1
- AC 220-240V
- PF≥0.9
- CRI≥80
- SAA
- RoHS
- CE

Code	Watt	Size(AxBmm)	Cut-out(mm)	Lumen(±5%)	N.W/pc(kgs)	Q'ty/CTN
JDL264-3-10W	10W	Ø115x67mm	Ø90-95mm	950lm	0.21	30PCS
JDL264-3-13W	13W	Ø115x67mm	Ø90-95mm	1200lm	0.21	30PCS
JDL264-4-13W	13W	Ø145x73mm	Ø120-130mm	1200lm	0.26	24PCS
JDL264-4-18W	18W	Ø145x73mm	Ø120-130mm	1500lm	0.26	24PCS
JDL264-5-13W	13W	Ø170x86mm	Ø140-150mm	1350lm	0.31	24PCS
JDL264-5-18W	18W	Ø170x86mm	Ø140-150mm	1850lm	0.31	24PCS
JDL264-5-25W	25W	Ø170x86mm	Ø140-150mm	2650lm	0.31	24PCS
JDL264-6-18W	18W	Ø190x90mm	Ø160-170mm	1850lm	0.36	12PCS
JDL264-6-25W	25W	Ø190x90mm	Ø160-170mm	2650lm	0.36	12PCS
JDL264-6-30W	30W	Ø190x90mm	Ø160-170mm	3150lm	0.36	12PCS
JDL264-8-18W	18W	Ø235x100mm	Ø200-210mm	1850lm	0.52	12PCS
JDL264-8-25W	25W	Ø235x100mm	Ø200-210mm	2650lm	0.52	12PCS
JDL264-8-35W	35W	Ø235x100mm	Ø200-210mm	3600lm	0.52	12PCS

CCT — 3000K 4000K 5000K 5700K

Trim — White Black

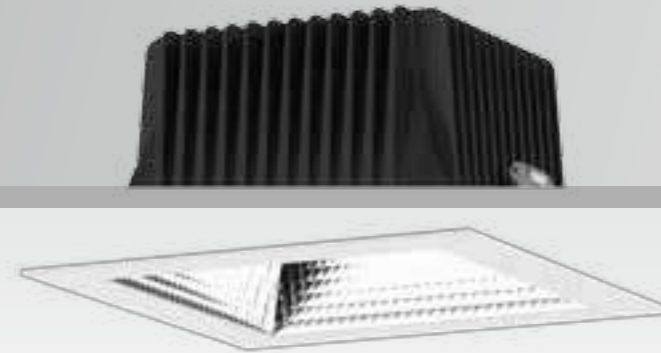

# JDL197 Downlight

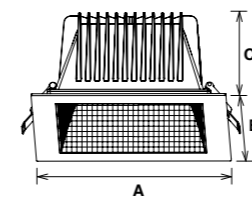

JDL197 SMD LED downlight is a square-trim LED downlight for accenting and comfortable lighting. Designed with a traditional deep reflector, the luminaire offers enhanced glare control(UGR<19). ADC12 Aluminum profile provides excellent thermal dissipation. IP44 waterproof in front for various application.

- 60°
- IP44
- UGR<19
- DIM
- DALI
- 0-10V
- TUNABLE WHITE
- SLIDE SWITCH 3 in 1
- AC 200-240V
- PF≥0.9
- CRI≥80
- RoHS
- CE

Code	Watt	Size(AxBxCmm)	Cut-out(mm)	Lumen(±5%)	N.W/pc(kgs)	Q'ty/CTN
JDL197-6-18W	18W	190x190x102	170x170	1760lm	1.02	8PCS
JDL197-6-22W	22W	190x190x102	170x170	2120lm	1.02	8PCS
JDL197-6-25W	25W	190x190x102	170x170	2420lm	1.02	8PCS
JDL197-6-32W	32W	190x190x102	170x170	3070lm	1.02	8PCS

CCT — 3000K 4000K 5000K 5700K

Trim — White Black



# JDL178 Downlight

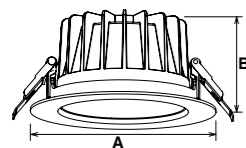

JDL178 downlight with deep-set reflector provides better glaring control(UGR<19).The luminaire with modular design offers a wide choice of beam angles, 24°/36°/60°for optional. Adopted COB CITIZEN brand to reach high efficiency 110lm/W and energy saving. The luminaire blends harmoniously into ceilings, making it ideal for commercial and residential applications.

### Reflector



- ▶
- ▶
- ▶
- ▶



Code	Watt	Size(AxBmm)	Cut-out(mm)	Lumen(±5%)	N.W/pc(kgs)	Q'ty/CTN
JDL178A-3-10W	10W	Ø95x54	Ø82-88	1120lm	0.23	36PCS
JDL178B-3-10W	10W	Ø110x54	Ø90-95	1120lm	0.27	36PCS
JDL178B-3-13W	13W	Ø110x54	Ø90-95	1300lm	0.27	36PCS
JDL178-4-10W	10W	Ø145x78	Ø125-135	1150lm	0.48	18PCS
JDL178-4-18W	18W	Ø145x78	Ø125-135	2250lm	0.48	18PCS
JDL178-4-25W	25W	Ø145x78	Ø125-135	2750lm	0.48	18PCS
JDL178-6-18W	18W	Ø172x90	Ø150-165	2200lm	0.71	12PCS
JDL178-6-25W	25W	Ø172x90	Ø150-165	2850lm	0.71	12PCS
JDL178-6-35W	35W	Ø172x90	Ø150-165	3670lm	0.71	12PCS
JDL178-8-18W	18W	Ø228x99	Ø200-210	2070lm	1.14	12PCS
JDL178-8-25W	25W	Ø228x99	Ø200-210	2850lm	1.14	12PCS
JDL178-8-35W	35W	Ø228x99	Ø200-210	4000lm	1.14	12PCS
JDL178-8-40W	40W	Ø228x99	Ø200-210	4200lm	1.14	12PCS
JDL178-8-45W	45W	Ø228x99	Ø200-210	4700lm	1.14	12PCS

CCT 2700K 3000K 4000K 5000K Trim White Black Silver



# JDL179 Downlight

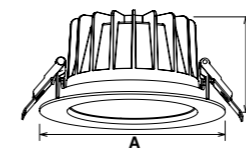

JDL179 SMD LED downlight, designed with a traditional deep reflector and die-casting housing, provides perfect and comfortable lighting and excellent thermal dissipation. External driver solution both in dimmable and non-dimmable version achieves great dimming compatibility with world brand dimmers.

### Reflector



- ▶
- ▶
- ▶
- ▶



Code	Watt	Size(AxBmm)	Cut-out(mm)	Lumen(±5%)	N.W/pc(kgs)	Q'ty/CTN
JDL179A-3-10W	10W	Ø95x54	Ø82-88	830lm	0.23	36PCS
JDL179B-3-10W	10W	Ø110x54	Ø90-95	870lm	0.27	36PCS
JDL179B-3-13W	13W	Ø110x54	Ø90-95	1140lm	0.27	36PCS
JDL179-4-10W	10W	Ø145x78	Ø125-135	900lm	0.46	18PCS
JDL179-4-18W	18W	Ø145x78	Ø125-135	1950lm	0.46	18PCS
JDL179-4-25W	25W	Ø145x78	Ø125-135	2250lm	0.46	18PCS
JDL179-6-18W	18W	Ø172x90	Ø150-165	1900lm	0.67	12PCS
JDL179-6-25W	25W	Ø172x90	Ø150-165	2650lm	0.67	12PCS
JDL179-6-35W	35W	Ø172x90	Ø150-165	3180lm	0.67	12PCS
JDL179-8-18W	18W	Ø228x99	Ø200-210	2070lm	1.08	12PCS
JDL179-8-25W	25W	Ø228x99	Ø200-210	2800lm	1.08	12PCS
JDL179-8-35W	35W	Ø228x99	Ø200-210	4000lm	1.08	12PCS
JDL179-8-40W	40W	Ø228x99	Ø200-210	4400lm	1.08	12PCS
JDL179-8-45W	45W	Ø228x99	Ø200-210	4950lm	1.08	12PCS

CCT 3000K 4000K 5000K 5700K Trim White Black Silver



## JDL98A/B Downlight

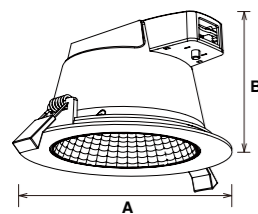

JDL98 integrated SMD LED downlight series, a high-performance LED downlight for accenting and general lighting, has two reflector design optional, JDL98A with faceted reflector and JDL98B with specular reflector. The luminaire is easy to install with the combination of ingrated driver and fast connector. Triac dimmable and 3CCT are available.

### Reflector

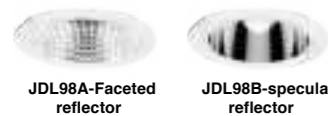

- ▶
- ▶
- ▶
- ▶



Code	Watt	Size(AxBmm)	Cut-out(mm)	Lumen(±5%)	N.W/pc(kgs)	Q'ty/CTN
JDL98-3-6W	6W	Ø110x70	Ø90-95	610lm	0.18	24PCS
JDL98-4-13W	13W	Ø145x82	Ø125-135	1460lm	0.28	24PCS
JDL98-6-18W	18W	Ø172x95	Ø150-165	1890lm	0.35	12PCS
JDL98-8-18W	18W	Ø228x98	Ø200-210	2110lm	0.54	12PCS
JDL98-8-25W	25W	Ø228x98	Ø200-210	2930lm	0.54	12PCS

CCT — 3000K — 4000K — 5000K — 5700K

Trim — White Black



## JDL138A/B Downlight

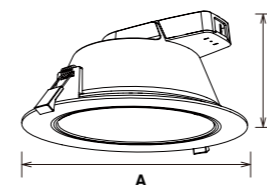

JDL138 series SMD LED downlight, slide switch for color selection, is good for home and commercial project requirement. IP54 rated is available for bathrooms and other wet locations. JDL98B 60° beam angle with specular reflector can reach UGR<19.

### Reflector

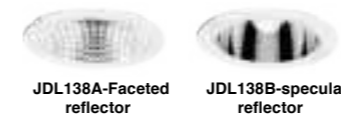

- ▶
- ▶
- ▶
- ▶



Code	Watt	Size(AxBmm)	Cut-out(mm)	Lumen(±5%)	N.W/pc(kgs)	Q'ty/CTN
JDL138-3-6W	6W	Ø110x70	Ø90-95	560lm	0.24	24PCS
JDL138-4-13W	13W	Ø145x82	Ø125-135	1390lm	0.34	24PCS
JDL138-6-18W	18W	Ø172x95	Ø150-165	1780lm	0.45	12PCS
JDL138-8-18W	18W	Ø228x98	Ø200-210	2110lm	0.65	12PCS
JDL138-8-25W	25W	Ø228x98	Ø200-210	2880lm	0.65	12PCS

CCT — 3000K — 4000K — 5000K — 5700K

Trim — White Black



## JDL83 Downlight

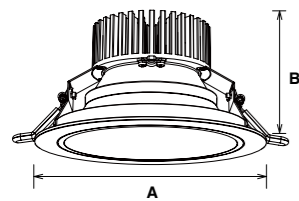

JDL83 SMD downlight, a high-performance LED downlight for accenting and general lighting. Designed with a micro prism diffuser, the luminaire provides enhanced glare control and leading performance, making it ideal for commercial and residential environments. ADC12 Aluminum profile design guarantee long lifespan.

- ▶ 60° IP20
- ▶ DIM DALI 0-10V
- ▶ AC 200-240V PF≥0.9 CRI≥80
- ▶ SAA RoHS CE



Code	Watt	Size(AxBmm)	Cut-out(mm)	Lumen(±5%)	N.W/pc(kgs)	Q'ty/CTN
JDL83-3-13W	13W	Ø110x80	Ø90-100	1160lm	0.33	30PCS
JDL83-6-25W	25W	Ø190x100	Ø160-180	2620lm	0.76	12PCS
JDL83-8-35W	35W	Ø230x110	Ø200-220	3700lm	0.98	12PCS

CCT — 3000K 4000K 5000K 5700K

Trim — White Black Silver



## JCL94 Downlight

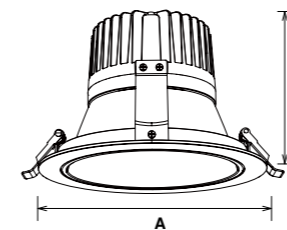

JCL94 LED downlight designed with a deep reflector, provides optimal glare control(UGR<19). It adopts brand CITIZEN COB for uniform and accenting lighting. Ideal for commercial and residential applications looking for a clean, minimalist look.

- ▶ 36° 45° IP20 UGR<19
- ▶ DIM DALI 0-10V
- ▶ AC 200-240V PF≥0.9 CRI≥80 CRI≥90 CRI≥97
- ▶ SAA RoHS CE



Code	Watt	Size(AxBmm)	Cut-out(mm)	Lumen(±5%)	N.W/pc(kgs)	Q'ty/CTN
JCL94-3-13W	13W	Ø110x100	Ø95-100	920lm	0.38	24PCS
JCL94-6-25W	25W	Ø190x127	Ø165-180	2550lm	0.85	12PCS
JCL94-8-35W	35W	Ø230x140	Ø205-220	3350lm	1.20	12PCS

CCT — 2700K 3000K 4000K 5000K

Trim — White Black Silver



# JDL176 Downlight

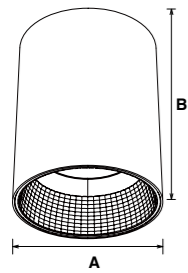

JDL176 downlight with deep-set reflector provides better glaring control(UGR<19). It offers a wide choice of outputs, beam angles and color rendering options. Surface mounted down light with no-screw outside fixation provide a much cleaner out-looking design. Built-in driver, easy for installation.

- ▶ 24° 36° 60°
- ▶ IP54 UGR<19
- ▶ DIM DALI
- ▶ AC 200-240V PF≥0.9 CRI≥80 CRI≥90 CRI≥97
- ▶ SAA RoHS CE CB

Code	Watt	Size(AxBmm)	Lumen(±5%)	N.W/pc(kgs)	Q'ty/CTN
JDL176-15W	15W	Ø100x134	1750lm	0.65	18PCS
JDL176-25W	25W	Ø120x144	2800lm	0.84	12PCS
JDL176-35W	35W	Ø170x159	3900lm	1.45	6PCS

CCT — 2700K 3000K 4000K 5000K Finish — White Black Silver

# JDL38 Downlight

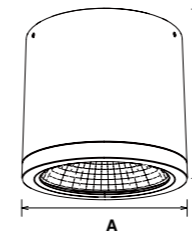

JDL38 surface mounted downlight is a high-performance LED luminaire that can simultaneously or individually offer uniform and excellent light. It offers a wide choice of beam angles 24°/36°/45°/60° for optional. AL6063 Aluminum body with oxidation treatment provides excellent heat dissipation performance.

- ▶ 24° 36° 45° 60°
- ▶ IP54
- ▶ DIM DALI
- ▶ AC 100-240V AC 200-240V PF≥0.9 CRI≥80 CRI≥90 CRI≥97
- ▶ SAA RoHS CE

Code	Watt	Size(AxBmm)	Lumen(±5%)	N.W/pc(kgs)	Q'ty/CTN
JDL38-10W	10W	Ø90x100	890lm	0.52	24PCS
JDL38-15W	15W	Ø90x100	1600lm	0.52	24PCS
JDL38-25W	25W	Ø120x110	3070lm	0.75	18PCS
JDL38-30W-DA	30W	Ø160x120	3500lm	1.50	12PCS
JDL38-32W	32W	Ø160x120	3540lm	1.50	12PCS

CCT — 2700K 3000K 4000K 5000K Finish — White Black Silver



# JDL160 Downlight

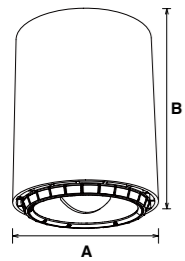

JDL160 DIY modular design is a high-performance LED downlight for premium hotel and high-end commercial project requirement. Adjustable beam angle from 20° to 70° for accenting and general lighting. Available in an array of trims and accessories, these luminaires are here to outperform to fit into ceiling, recessed, and track mounting installation.

- ▶ 20°-70° IP20
- ▶ DIM
- ▶ 

AC 100-240V	AC 220-240V	PF≥0.9	CRI≥80	CRI≥90	CRI≥97
-------------	-------------	--------	--------	--------	--------
- ▶ RoHS CE

Code	Watt	Size(AxBxCmm)	Lumen(±5%)	N.W/pc(kgs)	Q'ty/CTN
JDL160-25W	25W	Ø100x131.5	3250lm	0.98	18PCS
JDL160-100-A	Trim	Ø100x66	Trim	0.35	36PCS
JDL160-175-B	Trim	Ø175x48	Trim	0.35	24PCS
JDL160-175-C	Trim	175x175x48	Trim	0.40	24PCS
JL-TL147-25W	Adapter	Ø100x157x108	Adapter	0.45	24PCS

CCT ——— 2700K 3000K 4000K 5000K      Finish ——— White Black Silver

## JDL160 DIY module

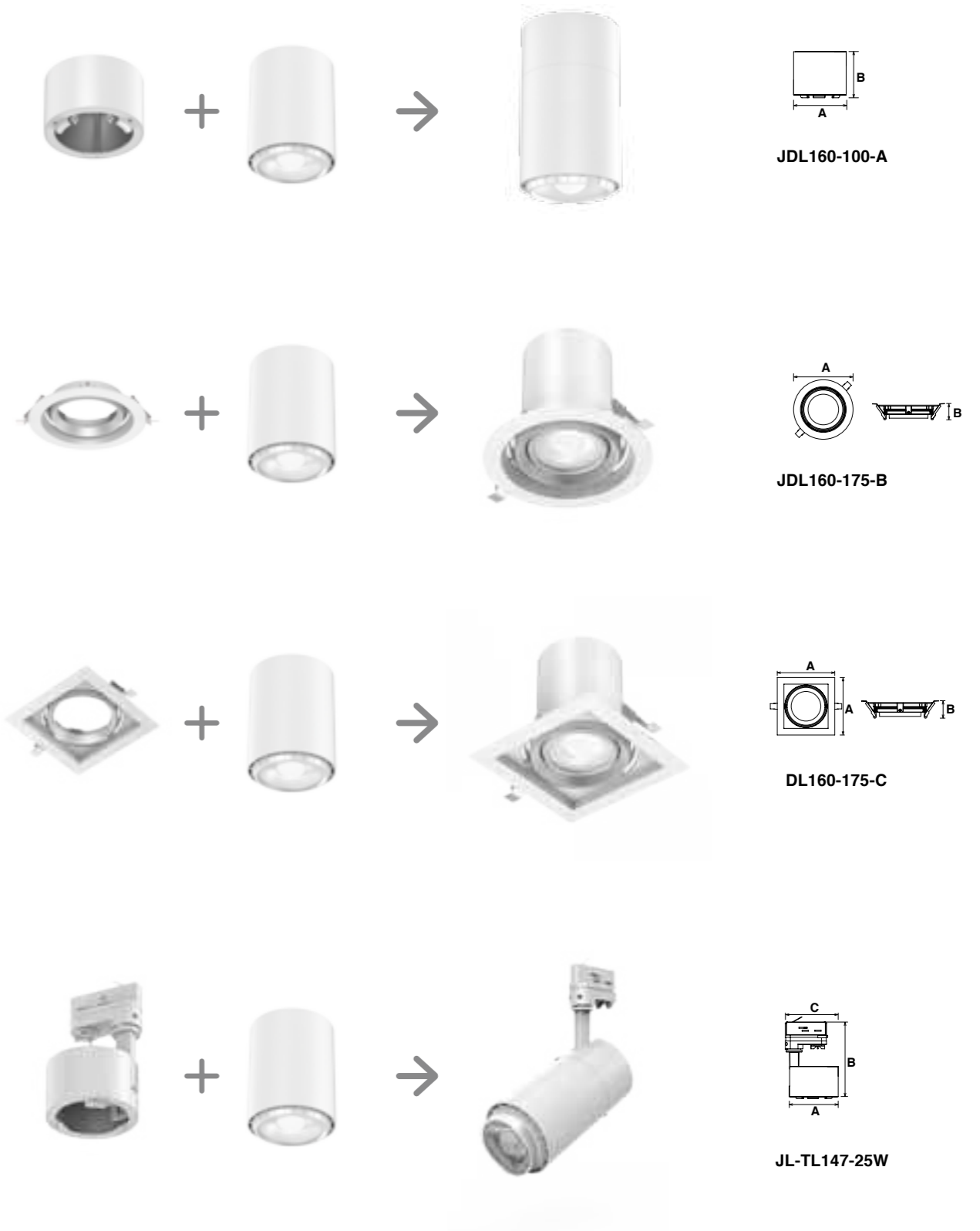







# JDL244 Downlight

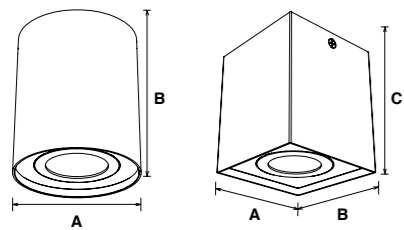

JDL244 surface mounted downlight, adopting high lumen COB 100lm/W, ADC12 heat sink and multi-layer structure provide excellent thermal dissipation. Built-in driver solution both in dim and Non-dim version achieves great dimming compatibility with the worldwide brand dimmers. 360° in horizontal and 23° in vertical and IP54 are available.

- ▶ 15° 24° 36° 60°
- ▶ IP54
- ▶ DIM
- ▶ AC 200-240V
- ▶ CRI ≥ 80
- ▶ RoHS
- ▶ CE

Code	Watt	Size(AxBxCmm)	Lumen(±5%)	N.W/pc(kgs)	Q'ty/CTN
JDL244-90-6W	6W	Ø90x108	730lm	0.44	24PCS
JDL244-90-10W	10W	Ø90x108	1090lm	0.44	24PCS
JDL244-90-6W	6W	90x90x108	730lm	0.52	24PCS
JDL244-90-10W	10W	90x90x108	1090lm	0.52	24PCS

CCT — 2700K 3000K 4000K 5000K

Finish — White Black Silver Nickel

## JDL244 Series

High transmittance lens  
evitcefler hgih dna  
noitpo rotcefler

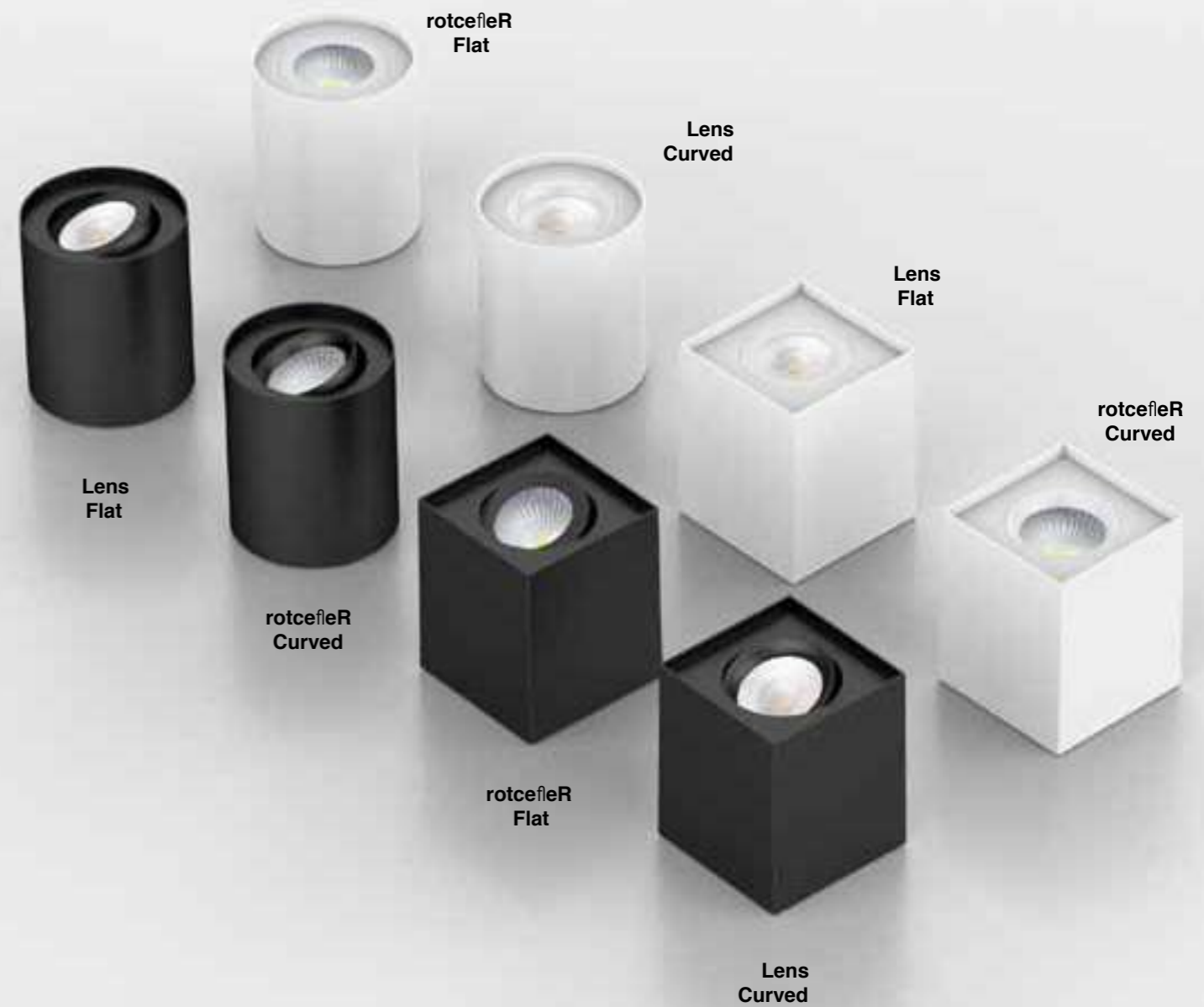



# JDL207 Downlight

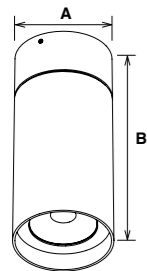

JDL207 surface mounted LED downlight, with the special design of adjusting lighting orientation, 330° rotate and 90° tilt. The luminaire adopts CITIZEN brand COB, makes uniform light and excellent lumen output. Aluminum profile with sufficient heat management guarantee long lifespan.

- ▶ 36° 60° 330° 90° IP20
- ▶ DIM
- ▶ AC 100-240V AC 200-240V CRI ≥ 80 CRI ≥ 90 CRI ≥ 97
- ▶ SAA RoHS CE

Code	Watt	Size(AxBmm)	Lumen(±5%)	N.W/pc(kgs)	Q'ty/CTN
JDL207-15W	15W	Ø85x186	1750lm	0.67	12PCS
JDL207-25W	25W	Ø85x211	2900lm	0.73	12PCS

CCT ——— 2700K 3000K 4000K 5000K      Finish ——— White Black Silver



LED Downlight  
Surface mounted &  
Pendant Series



# JDL266S Downlight

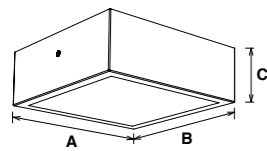

JDL266S surface mounted downlight adopts 2835 SMD and PMMA LGP. The die-casting aluminum frame provides a great thermal management. The external driver design and 3 CCT interchangeable are available.

- ▶ 120° IP20
- ▶ DIM
- ▶ AC 200-240V PF≥0.9 CRI≥80
- ▶ SAA RoHS CE

Code	Watt	Size(AxBxCmm)	Lumen(±5%)	N.W/pc(kgs)	Q'ty/CTN
JDL266-6W-S	6W	120x120x38	420lm	0.37	36PCS
JDL266-12W-S	12W	170x170x38	950lm	0.48	24PCS
JDL266-18W-S	18W	224x224x38	1500lm	0.77	12PCS
JDL266-24W-S	24W	300x300x38	2000lm	0.95	12PCS

CCT — 3000K 4000K 5000K 5700K 6500K Finish — White Black Silver

# JDL266R Downlight

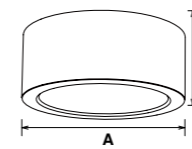

JDL266R surface mounted downlight adopts 2835 SMD and PMMA LGP. The die-casting aluminum frame provides a great thermal management. The external driver design and 3 CCT interchangeable are available.

- ▶ 120° IP20
- ▶ DIM
- ▶ AC 200-240V PF≥0.9 CRI≥80
- ▶ SAA RoHS CE

Code	Watt	Size(AxBmm)	Lumen(±5%)	N.W/pc(kgs)	Q'ty/CTN
JDL266-6W-R	6W	Ø120x38	420lm	0.35	36PCS
JDL266-12W-R	12W	Ø170x38	950lm	0.45	24PCS
JDL266-18W-R	18W	Ø224x38	1500lm	0.75	12PCS
JDL266-24W-R	24W	Ø300x38	2000lm	0.93	12PCS

CCT — 3000K 4000K 5000K 5700K 6500K Finish — White Black Silver





# JDL228A Downlight

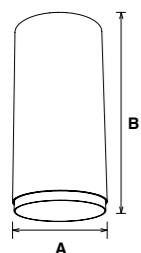

JDL228A adopt high lumen COB chip and PMMA lens for uniform light effect and enhanced glare control. Aluminum profile with sufficient heat dissipation guarantee long lifespan. It offers a wide choice of beam angles 24°/30°/36°/45°/60° for optional.

- ▶ 24° 30° 36° 45° 60° IP20
- ▶ DIM
- ▶ AC 200-240V PF≥0.9 CRI≥80 CRI≥90 CRI≥97
- ▶ SAA RoHS CE CB

Code	Watt	Size(AxBmm)	Lumen(±5%)	N.W/pc(kgs)	Q'ty/CTN
JDL228A-10W	10W	Ø65x157	1100lm	0.45	12PCS
JDL228A-15W	15W	Ø65x157 (Non-dim) Ø85x178 (Triac-dim)	1300lm	0.45	12PCS
JDL228A-20W	20W	Ø85x178	2250lm	0.67	12PCS
JDL228A-25W	25W	Ø85x178	2700lm	0.67	12PCS
JDL228A-30W	30W	Ø100x211	3050lm	1.00	12PCS
JDL228A-40W	40W	Ø100x211	4200lm	1.00	12PCS

CCT — 2700K 3000K 4000K 5000K Finish — White Black

Interchangeable lens options — 24°/30°/45° for 10W/15W 24°/36°/60° for 15W/20W/25W/30W/40W



# JDL228B Downlight

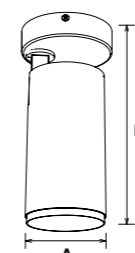

JDL228B surface mounted downlight with adjustable lighting orientation, 350° rotate and 90° tilt, It offers a wide choice of beam angles 24°/30°/36°/45°/60° for optional. Aluminum profile with sufficient heat dissipation guarantee long lifespan. Driver built-in, easy for installation.

- ▶ 24° 30° 36° 45°
- ▶ 60° 350° 90° IP20
- ▶ DIM
- ▶ AC 200-240V PF≥0.9 CRI≥80 CRI≥90 CRI≥97
- ▶ SAA RoHS CE CB

Code	Watt	Size(AxBmm)	Lumen(±5%)	N.W/pc(kgs)	Q'ty/CTN
JDL228B-10W	10W	Ø65x218	1100lm	0.55	12PCS
JDL228B-15W	15W	Ø65x218 (Non-dim) Ø85x241 (Triac-dim)	1300lm	0.55	12PCS
JDL228B-20W	20W	Ø85x241	2250lm	0.82	12PCS
JDL228B-25W	25W	Ø85x241	2700lm	0.82	12PCS
JDL228B-30W	30W	Ø100x274	3050lm	1.15	12PCS
JDL228B-40W	40W	Ø100x274	4200lm	1.15	12PCS

CCT — 2700K 3000K 4000K 5000K Finish — White Black

Interchangeable lens options — 24°/30°/45° for 10W/15W 24°/36°/60° for 15W/20W/25W/30W/40W



# JPD228 Downlight

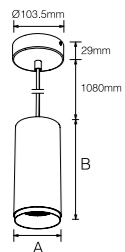

JPD228 pendant spot light is a high-performance LED luminaire that is ideal for commercial or residential applications. It adopts high lumen COB chip and PMMA lens for uniform light effect and enhanced glare control. AL6063 Aluminum profile with sufficient heat dissipation guarantee long lifespan.

- ▶ 24° 30° 36° 45° 60° IP20
- ▶ DIM
- ▶ AC 200-240V PF ≥ 0.9 CRI ≥ 80 CRI ≥ 90 CRI ≥ 97
- ▶ SAA RoHS CE CB

Code	Watt	Size(AxBmm)	Lumen(±5%)	N.W/pc(kgs)	Q'ty/CTN
JPD228-10W	10W	Ø65x157	1100lm	0.55	12PCS
JPD228-15W	15W	Ø65x157 (Non-dim) Ø85x178 (Triac-dim)	1300lm	0.55	12PCS
JPD228-20W	20W	Ø85x178	2250lm	0.80	12PCS
JPD228-25W	25W	Ø85x178	2700lm	0.80	12PCS
JPD228-30W	30W	Ø100x211	3050lm	1.15	12PCS
JPD228-40W	40W	Ø100x211	4200lm	1.15	12PCS

CCT — 2700K 3000K 4000K 5000K Finish — White Black

Interchangeable lens options — 24°/30°/45° for 10W/15W 24°/36°/60° for 15W/20W/25W/30W/40W



# JPD02A & B Downlight

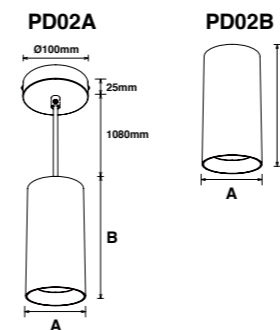

JPD02A pendant spot light and JPD02B surface mounted downlight with stylish appearance, making it ideal for commercial and residential applications looking for a clean, minimalist look. Adopted brand CREE COB for uniform and accenting lighting. Aluminum profile with sufficient heat management guarantee long lifespan. Aluminum profile with sufficient heat management guarantee long lifespan.

- ▶ 10° 15° 24° 36° IP20
- ▶ DIM
- ▶ AC 100-240V AC 200-240V PF ≥ 0.9 CRI ≥ 80 CRI ≥ 90 CRI ≥ 97
- ▶ SAA RoHS CE

Code	Watt	Size(AxBmm)	Lumen(±5%)	N.W/pc(kgs)	Q'ty/CTN
JPD02A-10W	10W	Ø80x130	1030lm	0.75	24PCS
JPD02A-18W	18W	Ø80x160	1800lm	0.81	24PCS
JPD02A-25W	25W	Ø112.5x160	2765lm	0.95	24PCS
JPD02B-10W	10W	Ø80x130	900lm	0.50	24PCS
JPD02B-18W	18W	Ø80x160	1660lm	0.56	24PCS
JPD02B-25W	25W	Ø112.5x160	2765lm	0.75	24PCS

CCT — 2700K 3000K 4000K 5000K Finish — White Black

Decoration Ring — White Black Other



## JDL115A/B Downlight

## JPD05A/B Downlight

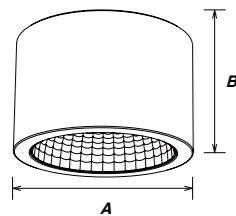

JDL115A/B SMD compact and neat surface mounted downlight series with 3 CCT in 1 lamp optional, slide switch for color selection are good for commercial project requirement. An IP54-rated version for indoor use. 60° beam angle with specular reflector can reach UGR<19.

### Reflector

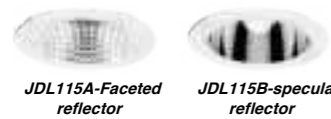

- ▶ 60° 90°
- ▶ IP54 UGR<19
- ▶ DIM SLIDE SWITCH 3 in 1
- ▶ AC 100-277V AC 200-240V PF≥0.9 CRI≥80
- ▶ SAA RoHS CE



Code	Watt	Size(AxBmm)	Lumen(±5%)	N.W/pc(kgs)	Q'ty/CTN
JDL115-4-13W	13W	Ø143x112	1460lm	0.39	12PCS
JDL115-6-18W	18W	Ø170x124	1890lm	0.49	12PCS
JDL115-8-25W	25W	Ø213x129	2930lm	0.80	12PCS

CCT — 3000K 4000K 5000K 5700K Finish — White Black Silver

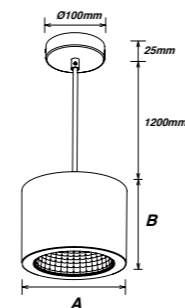

JPD05A/B SMD pendant downlight series with 3 CCT in 1 lamp optional, slide switch for color selection is good for commercial project requirement. 60° beam angle with specular reflector can reach UGR<19.

### Reflector



- ▶ 60° 90°
- ▶ IP20 UGR<19
- ▶ DIM SLIDE SWITCH 3 in 1
- ▶ AC 100-277V AC 200-240V PF≥0.9 CRI≥80
- ▶ SAA RoHS CE



Code	Watt	Size(AxBmm)	Lumen(±5%)	N.W/pc(kgs)	Q'ty/CTN
JPD05-4-13W	13W	Ø143x110	1460lm	0.65	12PCS
JPD05-6-18W	18W	Ø170x123	1890lm	0.83	12PCS
JPD05-8-25W	25W	Ø213x127	2930lm	1.06	12PCS

CCT — 3000K 4000K 5000K 5700K Finish — White Black Silver



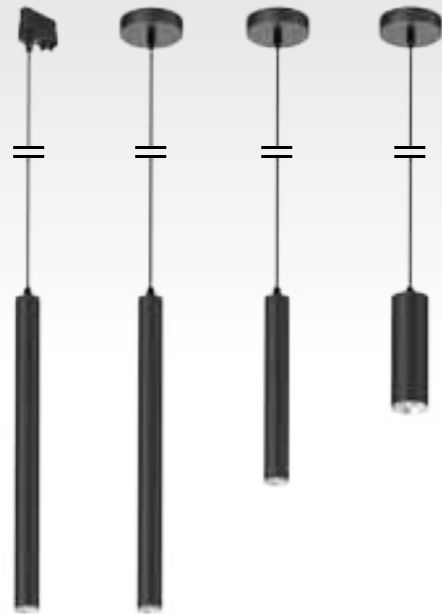

## JPD12 Downlight

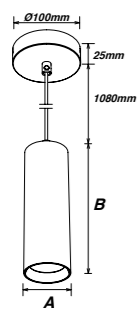

JPD12 pendant spot light with slim and stylish appearance is good for home and commercial project requirement. It offers a wide choice of beam angles 15°/24°/36°/60° for optional. Different colors of trim is optional for creating diversified light atmosphere.

- ▶ 15° 24° 36° 60°
- ▶ IP20 UGR<19
- ▶ AC 200-240V CRI≥80 CRI≥90 CRI≥97
- ▶ SAA RoHS CE

Code	Watt	Size(AxBmm)	Lumen(±5%)	N.W/pc(kgs)	Q'ty/CTN
JPD12-5W	5W	Ø39x300	500lm	0.51	18PCS
JPD12-5W	5W	Ø39x500	500lm	0.65	18PCS
JPD12-10W	10W	Ø58x180	1000lm	0.54	12PCS

CCT — 2700K 3000K 4000K 5000K Finish — White Black Silver

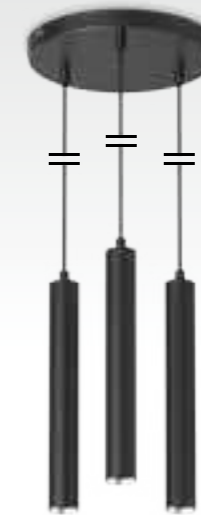

## JPD12B Downlight

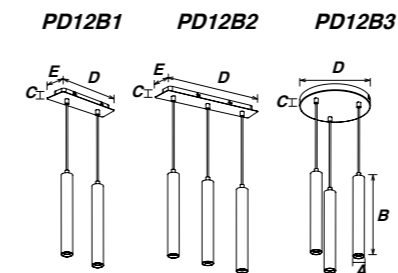

JPD12B cylinder large pendant is a high-performance LED luminaire that is ideal for commercial and residential applications. It offers a wide choice of beam angles 15°/24°/36°/60° for optional. Different colors of trim is optional for creating diversified light atmosphere.

- ▶ 15° 24° 36° 60°
- ▶ IP20 UGR<19
- ▶ AC 200-240V CRI≥80 CRI≥90 CRI≥97
- ▶ RoHS CE



Code	Watt	Size(AxBxCxDxEmm)	Lumen(±5%)	N.W/pc(kgs)	Q'ty/CTN
JPD12B1-10W	10W	Ø39x300x26x250x80	1100lm	1.20	6PCS
JPD12B2-15W	15W	Ø39x300x26x370x80	1650lm	1.80	6PCS
JPD12B3-15W	15W	Ø39x300x25xØ240	1650lm	1.80	6PCS

CCT — 2700K 3000K 4000K 5000K Finish — White Black Silver



# LED Ceiling Light

/Series/

LED ceiling light in all its forms—most of the time plays a secondary role of attention but attach great importance to the general lighting of a room.

It puts your room in best lighting effect by innovative lighting solutions and design. Jibe Lighting's ceiling light series has a low profile design providing a discreet, robust and stylish emergency, sensor and main luminaires.

It's with Elegantly slim and offered as both emergency and mains luminaires. It allows same seamless profile to be used throughout an installation. All options in the range are ideal for all projects when a high quality luminaire is required. Offering wide flexibility in facility lighting which is best suited to residential and commercial areas.

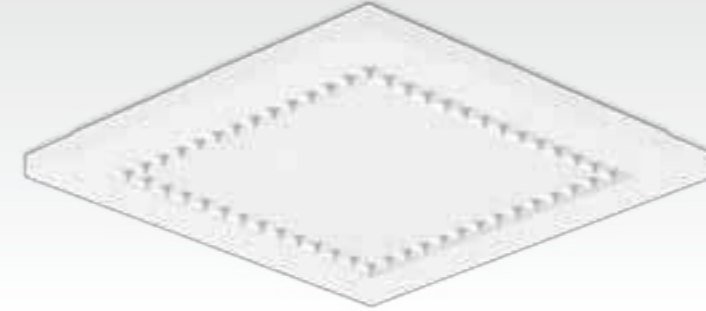

# JAL37 Ceiling light

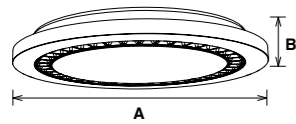

JAL37 Anti-glare LED ceiling light adopts multi-louver reflectors, effectively reduces glare index(UGR) to protecting human eyes. High luminous efficiency, 94-V0 fire-rated PC material housing and fast connection terminal design make it to be widely used in various lighting applications. Microwave Sensor and Triac dimmable function are available.

- ▶ 100°
- ▶
- ▶
- ▶

Code	Watt	Size(AxBmm)	Lumen(±5%)	N.W/pc(kgs)	Q'ty/CTN
JAL37-10-12W	12W	Ø250x33	1520lm	0.54	20PCS
JAL37-12-15W	15W	Ø300x33	2000lm	0.80	10PCS
JAL37-16-25W	25W	Ø400x33	3120lm	1.33	10PCS

CCT — 3000K 4000K 5000K 5700K

Finish — White

# JAL38 Ceiling light

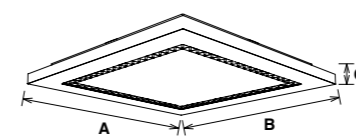

JAL38 Anti-glare square ceiling light adopts multi-louver reflectors, effectively reduces glare index(UGR) to protecting human eyes. High luminous efficiency, 94-V0 fire-rated PC material housing and fast connection terminal design make it to be widely used in various lighting applications. Microwave Sensor and Triac dimmable function are available.

- ▶ 100°
- ▶
- ▶
- ▶

Code	Watt	Size(AxBxCmm)	Lumen(±5%)	N.W/pc(kgs)	Q'ty/CTN
JAL38-10-12W	12W	250x250x33	1560lm	0.66	20PCS
JAL38-12-15W	15W	300x300x33	1890lm	0.90	10PCS
JAL38-16-25W	25W	400x400x33	3050lm	1.58	10PCS

CCT — 3000K 4000K 5000K 5700K

Finish — White



# JAL08B Ceiling light

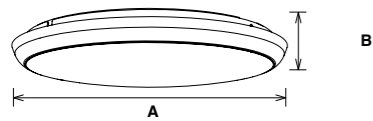

JAL08B is a classical and functional ceiling light, especially in emergency, sensor, 3CCT changeable (by slide switch or remote control), triac dimmable functions etc. Meanwhile it's with IP54 waterproof design, 8/10/12/14/16 inch sizes as options, It's ideal luminaire to any indoor applications.

- ▶ 120° IP54
- ▶ DIM SLIDE SWITCH Wireless Smart Lighting
- ▶ AC 200-240V PF ≥ 0.9 CRI ≥ 80
- ▶ SAA RoHS CE CB TÜV Rheinland CERTIFIED



Code	Watt	Size(AxBmm)	Lumen(±5%)	N.W/pc(kgs)	Q'ty/CTN
JAL08B-8-12W	12W	Ø200x48	1330lm	0.42	20PCS
JAL08B-10-12W	12W	Ø250x48	1300lm	0.66	20PCS
JAL08B-12-18W	18W	Ø300x40	2060lm	0.80	10PCS
JAL08B-12-25W	25W	Ø300x40	2650lm	0.80	10PCS
JAL08B-14-25W	25W	Ø350x40	2900lm	1.30	10PCS
JAL08B-16-30W	30W	Ø400x52	3360lm	1.40	10PCS

CCT — 3000K 4000K 5000K 5700K

Finish — White Black Silver

Ring — Nickel Brushed 10"- 250mm / 12"- 300mm



# JAL12B Ceiling light

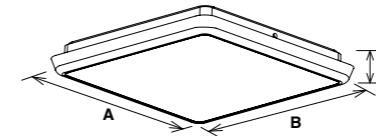

JAL12B is a classical and functional square ceiling light, especially in emergency, sensor, 3CCT changeable (by slide switch or remote control), triac dimmable functions etc. Meanwhile it's with IP54 waterproof design, 10/12/14/16 inch sizes as options, It's ideal luminaire to any indoor applications.

- ▶ 120° IP54
- ▶ DIM SLIDE SWITCH Wireless Smart Lighting
- ▶ AC 200-240V PF ≥ 0.9 CRI ≥ 80
- ▶ SAA RoHS CE CB TÜV Rheinland CERTIFIED



Code	Watt	Size(AxBxCmm)	Lumen(±5%)	N.W/pc(kgs)	Q'ty/CTN
JAL12B-10-12W	12W	250x250x50	1330lm	0.75	20PCS
JAL12B-12-18W	18W	300x300x40	1995lm	0.96	10PCS
JAL12B-12-25W	25W	300x300x40	2775lm	0.96	10PCS
JAL12B-14-25W	25W	350x350x41	2775lm	1.24	10PCS
JAL12B-16-30W	30W	400x400x51	3330lm	2.00	10PCS

CCT — 3000K 4000K 5000K 5700K

Finish — White Black Silver



# JAL85 Ceiling light

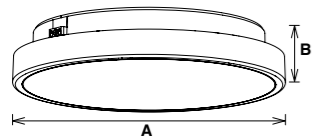

JAL85 is an economic and integrated slim design ceiling light with high luminous flux; Waterproof function (IP54) expand the application area; Presser device makes the installation easier; Triac dimmable, Color switchable combines dimmable both available.

- ▶
- ▶
- ▶

Code	Watt	Size(AxBmm)	Lumen(±5%)	N.W/pc(kgs)	Q'ty/CTN
JAL85-10-12W	12W	Ø250x64	1060lm	0.50	20PCS
JAL85-12-15W	15W	Ø300x66.5	1820lm	0.70	10PCS
JAL85-16-25W	25W	Ø400x69	2600lm	1.14	10PCS

CCT — 3000K 4000K 5000K 5700K      Finish — White Black Silver



# JAL87 Ceiling light

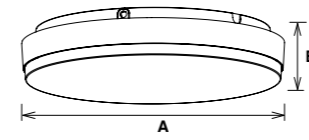

JAL87 is a new super slim design ceiling light, adopting high lumen SMD LED and lighter weight fire-rated material to ensure better heat resistance and corrosion resistance. The base and shade are detachable which make easier maintenance and installation. It also supports functions including Triac, 0-10V, DALI dimmable; Changeable power and 3 CCT by DIP switch(optional); Adjustable sensor and Emergency etc.

- ▶
- ▶
- ▶

Code	Watt	Size(AxBmm)	Lumen(±5%)	N.W/pc(kgs)	Q'ty/CTN
JAL87-11-12W	12W	Ø275x65	1460lm	0.70	12PCS
JAL87-11-18W	18W	Ø275x65	2200lm	0.70	12PCS
JAL87-11-25W	25W	Ø275x65	3000lm	0.70	12PCS
JAL87-14-25W	25W	Ø350x65	2900lm	1.00	6PCS
JAL87-14-30W	30W	Ø350x65	3200lm	1.00	6PCS

CCT — 3000K 4000K 5000K 5700K      Finish — White Black Silver



# JAL47 Ceiling light

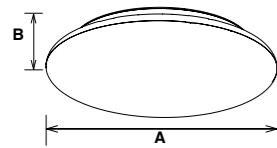

JAL47 is a flying saucer-shaped led ceiling light, super slim and minimalistic design. Replaceable built-in power supply design with easy maintenance. Easy installation, it is twist mounting after fixing the holder on the ceiling, avoid extra nail screw work, safe and convenient.

- ▶ 120°
- ▶
- ▶
- ▶

Code	Watt	Size(AxBmm)	Lumen(±5%)	N.W/pc(kgs)	Q'ty/CTN
JAL47-10-12W	12W	Ø250x53	1200lm	0.53	20PCS
JAL47-12-18W	18W	Ø300x58	1900lm	0.76	10PCS
JAL47-12-25W	25W	Ø300x58	2560lm	0.76	10PCS
JAL47-16-25W	25W	Ø400x66	2550lm	1.31	10PCS
JAL47-16-30W	30W	Ø400x66	3020lm	1.31	10PCS

CCT 





3000K
4000K
5000K
5700K

Finish 



White
Black
Silver

# JAL47S Ceiling light

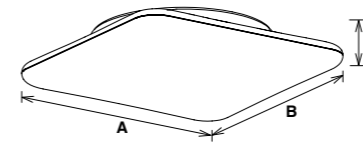

JAL47S is a square and flying saucer-shaped led ceiling light, super slim and minimalistic design. Replaceable built-in power supply design with easy maintenance. Easy installation, it is twist mounting after fixing the holder on the ceiling, avoid extra nail screw work, safe and convenient.

- ▶ 120°
- ▶
- ▶
- ▶

Code	Watt	Size(AxBxCmm)	Lumen(±5%)	N.W/pc(kgs)	Q'ty/CTN
JAL47S-12-18W	18W	300x300x58	1920lm	0.96	10PCS
JAL47S-12-25W	25W	300x300x58	2670lm	0.96	10PCS
JAL47S-16-25W	25W	400x400x58	2610lm	1.66	10PCS
JAL47S-16-30W	30W	400x400x58	3160lm	1.66	10PCS

CCT 





3000K
4000K
5000K
5700K

Finish 



White
Black
Silver



Flat



Curved  
(Recessed)

# JAL99 Ceiling light

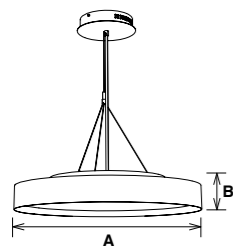

JAL99 ceiling light is with JAL6063 aluminum housing, SMD LED chips and Opal or Microprismatic diffuser. Size options: 400mm, 600mm, 800mm, 1000mm. It can do CCT adjustable and wattage adjustable, multiple installation ways available as surface mounted, recessed, Suspended. It is with Osram flicker free driver, DALI 2.0 with push dim available.

- ▶ 30% 20% 70% 80% 120° IP40
- ▶ DALI SLIDE SWITCH 3 IN 1 Adjustable Power
- ▶ AC 200-240V PF≥0.9 CRI≥80
- ▶ RoHS CE

Code	Watt	Size(AxBmm)	Lumen(±5%)	N.W/pc(kgs)	Q'ty/CTN
JAL99-16-40W	40W	Ø400x86	4300lm	3.20	6PCS
JAL99-24-60W	60W	Ø600x86	6500lm	4.50	2PCS
JAL99-32-80W	80W	Ø800x86	8600lm	6.80	1PCS
JAL99-40-100W	100W	Ø1000x86	10800lm	10.50	1PCS

CCT ——— 3000K 4000K 5000K 5700K

Finish ——— White Black



Steel wire suspension



Wire harness suspension



Pendant rod suspension

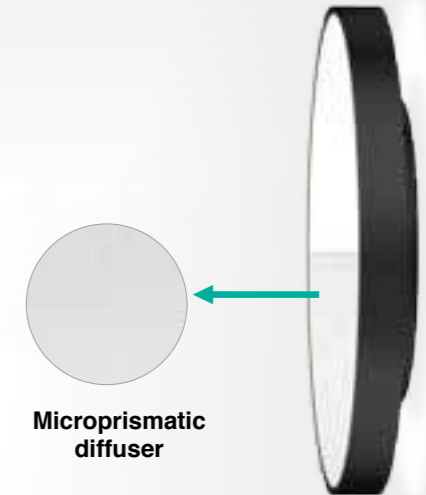

Microprismatic  
diffuser

Wall mounted  
(Indirect lighting)



Wall mounted  
(Direct lighting)

LED Ceiling light



## JAL24A Ceiling light

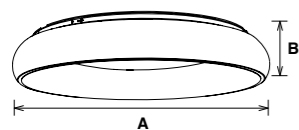

JAL24A is with hollow shape and curved light direction design, the circular light output offers a magic 3D effect; rotate buckle on the base to make installation easier and faster, it's very suitable for leisure location.

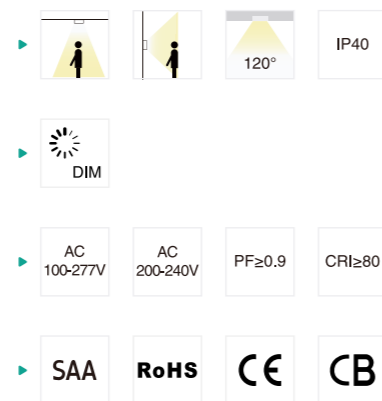

Code	Watt	Size(AxBmm)	Lumen(±5%)	N.W/pc(kgs)	Q'ty/CTN
JAL24A-12-18W	18W	Ø298x51	1450lm	1.08	10PCS
JAL24A-12-25W	25W	Ø298x51	2000lm	1.08	10PCS
JAL24A-16-35W	35W	Ø400x68	3100lm	1.89	6PCS

CCT — 3000K 4000K 5000K 5700K Finish — White Black Silver



## JAL24B Ceiling light

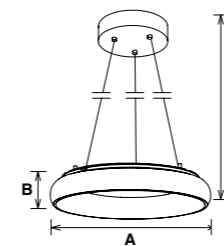

JAL24B is with hollow shape, curved light direction and suspended installation design, the circular light output offers a magic 3D effect; rotate buckle on the base to make installation easier and faster, it's very suitable for leisure location.

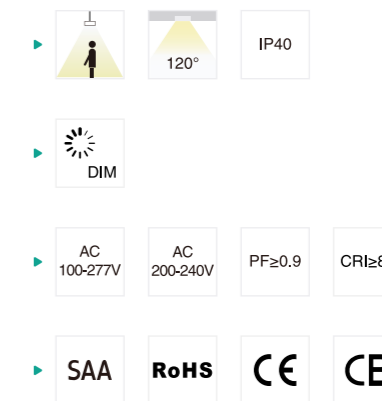

Code	Watt	Size(AxBxCmm)	Lumen(±5%)	N.W/pc(kgs)	Q'ty/CTN
JAL24B-12-18W	18W	Ø298x50x1525	1450lm	0.87	10PCS
JAL24B-12-25W	25W	Ø298x50x1525	2000lm	0.87	10PCS
JAL24B-16-35W	35W	Ø400x67x1542	3100lm	1.55	6PCS

CCT — 3000K 4000K 5000K 5700K Finish — White Black Silver





## JAL41A Ceiling light

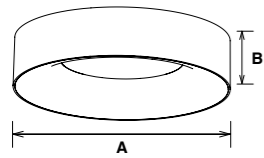

JAL41A ceiling light (full PC adopts elegant and concave design, it makes the luminous surface compact and with magic 3D effects. Surface mounted and suspended installation are also optional, equipped with rotating lamp fixture, makes the surface mounted installation much easier.

- ▶
- ▶
- ▶
- ▶

Code	Watt	Size(AxBmm)	Lumen(±5%)	N.W/pc(kgs)	Q'ty/CTN
JAL41A-12-18W	18W	Ø300x71	1710lm	1.04	6PCS
JAL41A-16-25W	25W	Ø400x71	2370lm	1.53	6PCS

CCT — 3000K 4000K 5000K 5700K    Finish — White Black Silver



## JAL41B Ceiling light

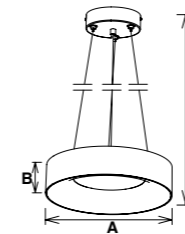

JAL41B ceiling light adopts elegant and concave design, it makes the luminous surface compact and with magic 3D effects. Surface mounted and suspended installation are also optional, equipped with rotating lamp fixture, makes the surface mounted installation much easier.

- ▶
- ▶
- ▶
- ▶

Code	Watt	Size(AxBxCmm)	Lumen(±5%)	N.W/pc(kgs)	Q'ty/CTN
JAL41B-12-18W	18W	Ø300x71x1200	1710lm	1.53	4PCS
JAL41B-16-25W	25W	Ø400x71x1200	2370lm	1.86	4PCS

CCT — 3000K 4000K 5000K 5700K    Finish — White Black Silver



# JAL51 Ceiling light

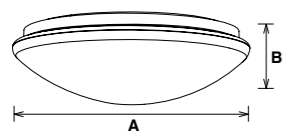

JAL51 is a Tri-CCT changeable ceiling light with PC diffuser and aluminum base, CCT is adjusted via a switch on the back of the lamp, 350mm and 380mm, 350mm available. It also comes with emergency function.

- ▶ IP20
- ▶ Smart Lighting
- ▶ AC 220-240V PF<sub>≥</sub>0.5 PF<sub>≥</sub>0.9 CRI<sub>≥</sub>80
- ▶ **RoHS**

Code	Watt	Size(AxBmm)	Lumen(±5%)	N.W/pc(kgs)	Q'ty/CTN
JAL51-14-16W	16W	Ø350x106	1570lm	0.64	5PCS
JAL51-15-25W	25W	Ø380x120	2500lm	0.74	5PCS

CCT — 3000K 4000K 5000K 5700K

Finish — White



# JAL71 Ceiling light

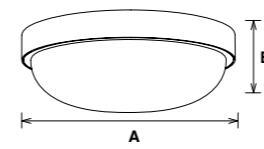

JAL71 is a new design IP54 grade ceiling light, which be with replaceable module design for fast installation, fire-rated PC diffuser, ensure safety performance. Triac dimmable available. It's widely use to bathroom and indoor corridor.

- ▶ IP54
- ▶ Smart Lighting
- ▶ AC 100-240V PF<sub>≥</sub>0.9 CRI<sub>≥</sub>80
- ▶ **RoHS**

Code	Watt	Size(AxBmm)	Lumen(±5%)	N.W/pc(kgs)	Q'ty/CTN
JAL71-12-8W	8W	Ø300x105	865lm	1.10	4PCS
JAL71-12-15W	15W	Ø300x105	1530lm	1.10	4PCS

CCT — 3000K 4000K 5000K 5700K

Finish — White Black Silver



## JAL42 Ceiling light

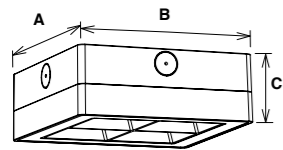

JAL42 is an anti-glare DIY ceiling light which with unique, compact and elegant design. It can be installed optionally into different shapes and images with available different frame color such as red, green, gray etc.

- ▶ IP20
- ▶ DIM
- ▶ AC 200-240V PF ≥ 0.9 CRI ≥ 80
- ▶ RoHS CE



Code	Watt	Size(AxBxCmm)	Lumen(±5%)	N.W/pc(kgs)	Q'ty/CTN
JAL42-6-12W	12W	160x160x62	940lm	0.56	24PCS

CCT — 3000K 4000K 5000K 5700K      Finish — White Black Gray



## JAL48 Ceiling light

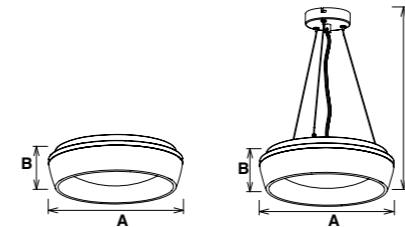

JAL48 is a luxurious decorative ceiling light which with faceted transparent cover, Tri-CCT changeable and dimmable function. surface mount and pendant install available.

- ▶ IP20
- ▶ DIM
- ▶ AC 200-240V PF ≥ 0.9 CRI ≥ 80
- ▶ RoHS CE

Code	Watt	Size(AxBmm)	Lumen(±5%)	N.W/pc(kgs)	Q'ty/CTN
JAL48-12-18W	18W	Ø300x87.5	1750lm	1.32	5PCS

CCT — 3000K 4000K 5000K 5700K      Finish — White



# JAL45 Ceiling light

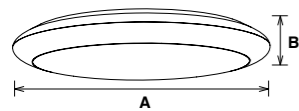

JAL45 is a module design ceiling light, easy to install and maintenance. It's with fire rated PC material, IP65 waterproof and IK10 impact resistant. It also supports dimmable, sensor, emergency version, 10/12/16/20 inch are available for this product.

- ▶ 120° IP65
- ▶ DIM DALI 0-10V SLIDE SWITCH 3 in 1 ((-))
- ▶ AC 200-240V PF≥0.9 CRI≥80
- ▶ SAA RoHS CE

Code	Watt	Size(AxBmm)	Lumen(±5%)	N.W/pc(kgs)	Q'ty/CTN
JAL45-10-12W	12W	Ø270x70	1280lm	0.76	10PCS
JAL45-12-18W	18W	Ø320x70	1940lm	1.00	6PCS
JAL45-12-25W	25W	Ø320x70	2700lm	1.00	6PCS
JAL45-16-25W	25W	Ø420x85	2650lm	1.59	6PCS
JAL45-16-30W	30W	Ø420x85	3150lm	1.59	6PCS
JAL45-20-30W	30W	Ø520x85	3180lm	2.40	6PCS
JAL45-20-35W	35W	Ø520x85	3670lm	2.40	6PCS
JAL45-20-40W	40W	Ø520x85	4160lm	2.40	6PCS

CCT 3000K 4000K 5000K 5700K

Finish White



# JAL52 Ceiling light

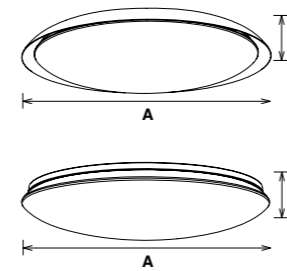

JAL52 is 2.4G wireless remote controller ceiling light, it supports dimmable, color changeable (controlled by switch/ remote controller/APP), night light, power off memory and timing switch functions etc. Low power consumption, fast switch between different functions, excellent stability and strong anti-interference capacity make this lamp outstanding.

- ▶ 120° IP20
- ▶ DIM
- ▶ AC 200-240V PF≥0.9 CRI≥80
- ▶ RoHS CE

Code	Watt	Size(AxBmm)	Lumen(±5%)	N.W/pc(kgs)	Q'ty/CTN
JAL52-45W(TYPE A)	45W	Ø600x106	3735lm	2.50	1PCS
JAL52-45W(TYPE B)	45W	Ø670x106	3735lm	2.80	1PCS

CCT 3000K 4000K 5700K

Finish White



# JAL55 Bulkhead

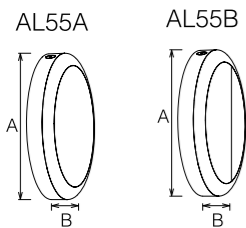

JAL55 is a ceiling light which comes with multifunctions, triac dimmable, emergency, sensor, color switchable, wattage switchable. Its cover can be circular and semi-circular diffuser to create different lighting effect, IP54 and IP65 optional.

- ▶
- ▶
- ▶
- ▶

Code	Watt	Size(AxBmm)	Lumen(±5%)	N.W/pc(kgs)	Q'ty/CTN
JAL55-12-15W	15W	Ø300x60	1480lm	0.96	6PCS

CCT — 3000K — 4000K — 5000K — 5700K

Finish — White Black

# JAL65 Bulkhead

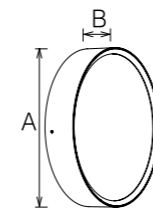

JAL65 is IP65 IK10 bulkhead which adopts Die-casting aluminum body and 94-V0 fire-rated PC cover. This fixture provides an alternative to the color changeable and Emergency function. These lights are a perfect answer to complete your outdoor look.

- ▶
- ▶
- ▶
- ▶

Code	Watt	Size(AxBmm)	Lumen(±5%)	N.W/pc(kgs)	Q'ty/CTN
JAL65-10-12W	12W	Ø250x58	1250lm	1.05	10PCS
JAL65-10-18W	18W	Ø250x58	1850lm	1.15	10PCS

CCT — 3000K — 4000K — 5000K — 5700K

Finish — White Black Gray

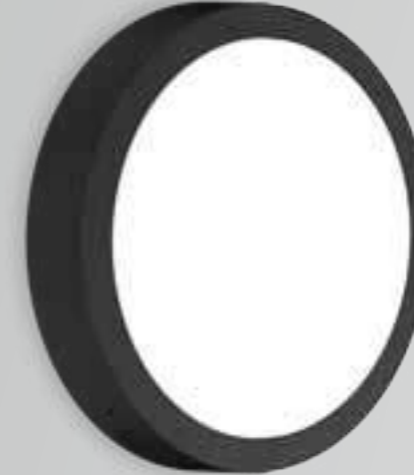

# JAL66 Bulkhead

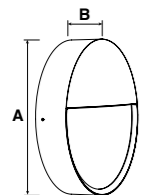

JAL66 is IP65 IK10 bulkhead which adopts Die-casting aluminum body and 94-V0 fire-rated PC cover. This fixture provides an alternative to the color changeable. These lights are a perfect answer to complete your outdoor look.

- ▶ IK10 IP65 110°
- ▶ DIM DALI 0-10V
- ▶ AC 200-240V PF ≥ 0.9 CRI ≥ 80
- ▶ SAA RoHS CE

Code	Watt	Size(AxBmm)	Lumen(±5%)	N.W/pc(kgs)	Q'ty/CTN
JAL66-10-12W	12W	Ø250x74	1100lm	1.10	10PCS

CCT — 3000K 4000K 5000K 5700K      Finish — White Black Gray

# JAL96 Bulkhead

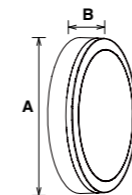

JAL96 is IP65 and IK10 LED ceiling light, which adopts high lumen SMD LED and lighter weight fire-rated material to ensure better heat resistance and corrosion resistance. Wall mounted and surface mounted for options. Multiple functions such as 3 CCT and power interchangeable, emergency, adjustable sensor, triac/0-10V/DALI dimmable are available.

- ▶ IK10 IP65 110°
- ▶ DIM DALI 0-10V Adjustable Power
- ▶ AC 100-240V PF ≥ 0.9 CRI ≥ 80
- ▶ SAA RoHS CE

Code	Watt	Size(AxBmm)	Lumen(±5%)	N.W/pc(kgs)	Q'ty/CTN
JAL96-8-12W	12W	Ø200x60	1250lm	0.48	12PCS
JAL96-11-12W	12W	Ø275x60	1350lm	0.85	12PCS
JAL96-11-18W	18W	Ø275x60	2000lm	0.85	12PCS
JAL96-11-25W	25W	Ø275x60	2650lm	0.85	12PCS
JAL96-14-25W	25W	Ø350x60	2850lm	1.38	6PCS
JAL96-14-30W	30W	Ø350x60	3150lm	1.38	6PCS

CCT — 3000K 4000K 5000K 5700K      Finish — White Black



# JAL91 Bulkhead

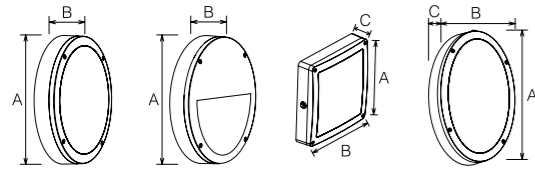

JAL91 is with multiple shapes design, including circular, semicircle, square and oval. Adopt high lumen SMD LED and lighter weight fire-rated material which can ensure better heat resistance and be with corrosion resistance. Wall mounted and surface mounted available. The base and shade are detachable which make easier maintenance and installation. Remote sensor control for 15W & 25W .

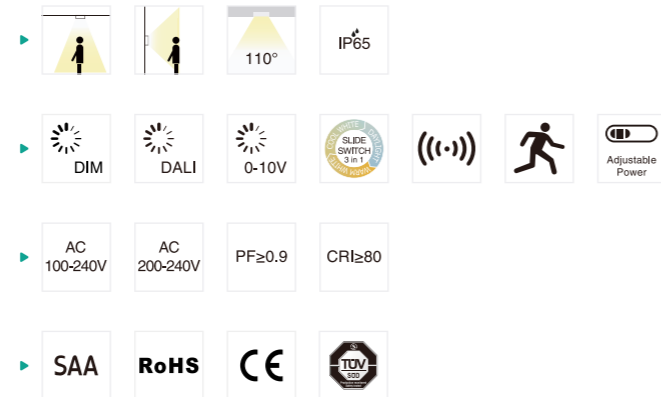

Code	Watt	Size(AxBxCmm)	Lumen(±5%)	N.W/pc(kgs)	Q'ty/CTN
JAL91-11-12W-Circular	12W	Ø275x59	1250lm	0.76	12PCS
JAL91-11-18W-Circular	18W	Ø275x59	1780lm	0.76	12PCS
JAL91-11-25W-Circular	25W	Ø275x59	2450lm	0.76	12PCS
JAL91-14-25W-Circular	25W	Ø350x59	2450lm	1.19	6PCS
JAL91-14-30W-Circular	30W	Ø350x59	2850lm	1.19	6PCS
JAL91-11-12W-Semicircle	12W	Ø275x59	1250lm	0.77	12PCS
JAL91-11-18W-Semicircle	18W	Ø275x59	1780lm	0.77	12PCS
JAL91-10-12W-Square	12W	242x242x59	1250lm	0.72	12PCS
JAL91-10-18W-Square	18W	242x242x59	1780lm	0.72	12PCS
JAL91-12-12W-Oval	12W	320x230x60	1250lm	0.78	12PCS
JAL91-12-18W-Oval	18W	320x230x60	1780lm	0.78	12PCS
JAL91-12-25W-Oval	25W	320x230x60	2450lm	0.78	12PCS

CCT — 3000K 4000K 5000K 5700K

Finish — White Black



# JAL91E Bulkhead

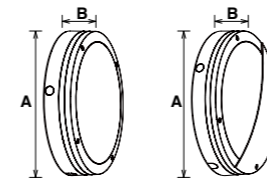

JAL91E LED ceiling light with modular design which adopts high lumen SMD LED, fire-rated material. It has a wide lighting area with down lighting and side lighting. IP65 and IK10 are suitable for outdoor application. Multiple functions: interchangeable CCT and power, adjustable sensor, emergency. And DALI/0-10V/Triac dimmable are available.

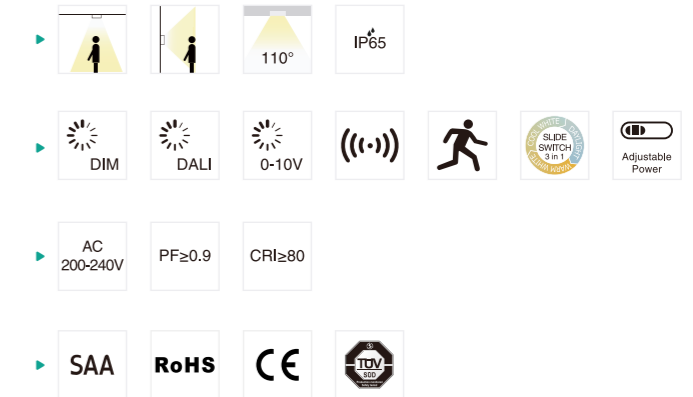

Code	Watt	Size(AxBmm)	Lumen(±5%)	N.W/pc(kgs)	Q'ty/CTN
JAL91E-11-12W(Circular)	15W	Ø275x67	1150lm	0.92	12PCS
JAL91E-11-18W(Circular)	18W	Ø275x67	1650lm	0.92	12PCS
JAL91E-11-25W(Circular)	25W	Ø275x67	2250lm	0.92	12PCS
JAL91E-11-12W(Semicircle)	12W	Ø275x68	750lm	0.95	12PCS
JAL91E-11-18W(Semicircle)	18W	Ø275x68	1100lm	0.95	12PCS
JAL91E-11-25W(Semicircle)	25W	Ø275x68	1550lm	0.95	12PCS

CCT — 3000K 4000K 5000K 5700K

Finish — White Black



# JAL104 Bulkhead

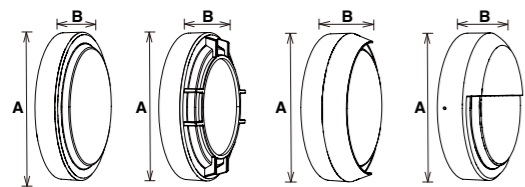

JAL104 is IP65 IK10 bulkhead which adopts Die-casting Aluminum body and 94-V0 fire-rated PC cover. This fixture is with four different trims and provides an alternative to color changeable, sensor and emergency functions. Dali and 0-10V dimming is also available.

- ▶
- ▶
- ▶
- ▶
- ▶

Code	Watt	Size(AxBmm)	Lumen(±5%)	N.W/pc(kgs)	Q'ty/CTN
JAL104A-10-15W	15W	Ø250X63	1750lm	1.05	10PCS
JAL104B-10-15W	15W	Ø250X68	1500lm	1.15	10PCS
JAL104C-10-15W	15W	Ø250X83	1600lm	1.19	10PCS
JAL104D-10-15W	15W	Ø250X67	1100lm	1.38	10PCS
JAL104A-12-25W	25W	Ø300X63	3000lm	1.58	6PCS
JAL104B-12-25W	25W	Ø300X68	2150lm	1.69	6PCS
JAL104C-12-25W	25W	Ø300X83	2600lm	1.73	6PCS
JAL104D-12-25W	25W	Ø300X67	1900lm	2.05	6PCS

CCT ——— 3000K 4000K 5000K 5700K

Finish ——— White Black

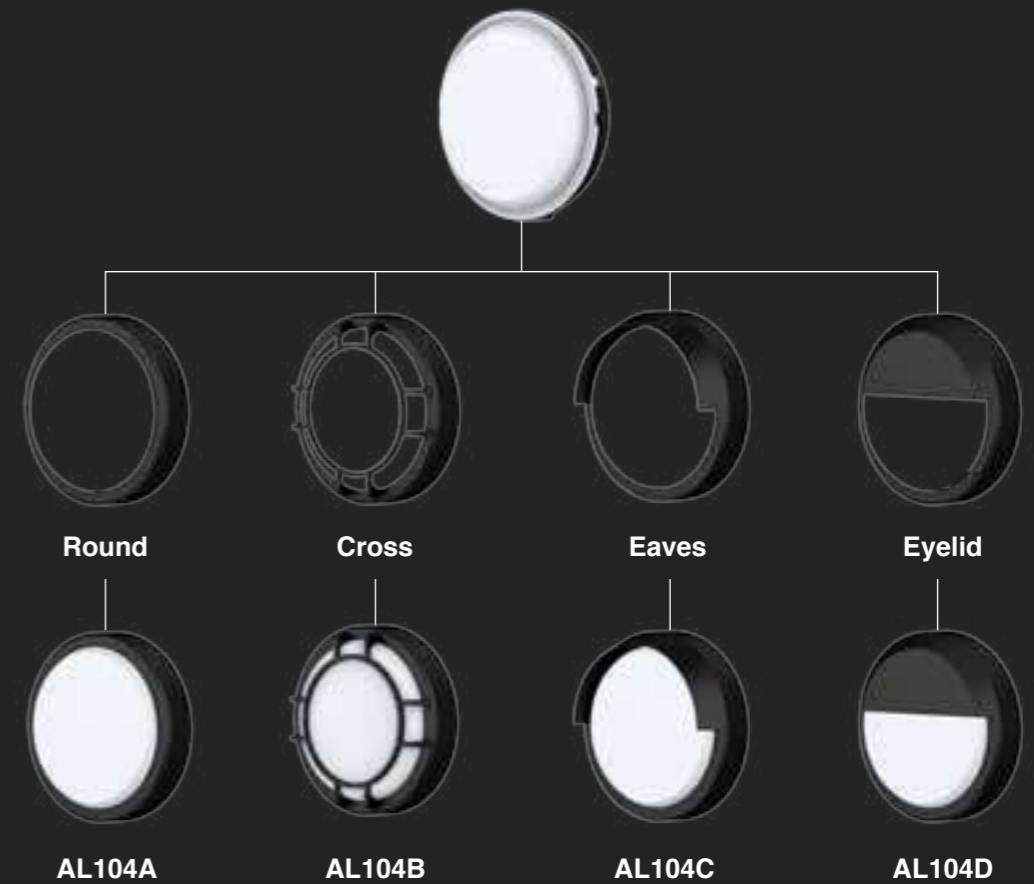

## FOUR DIFFERENT TRIMS





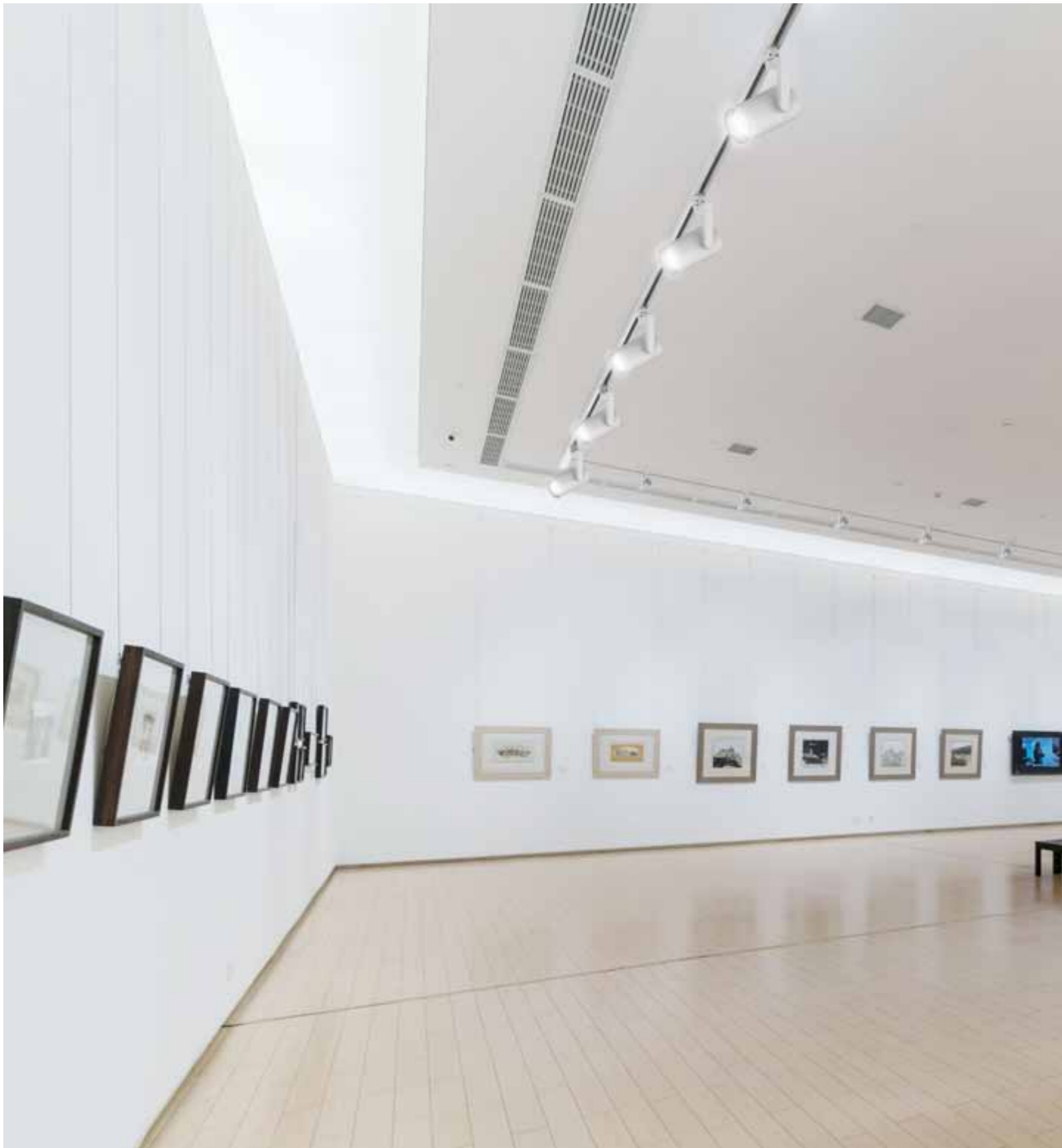

# LED Track Light /Series/

LED track light has been around for decades, yet it remains as fresh and contemporary a ceiling light fixture as ever. This is due primarily to its pure modern look, with clean, rigid tracks and streamlined directional heads. But function is also a factor when it comes to a track lighting system, with each of the selected track heads independently and easily adjustable and brightly focused. Complete track lighting kits will also allow you to have a stylish ceiling track lighting systems instantly. Jibe Lighting various track lights could be your excellent choice!



# JTL228 Track light

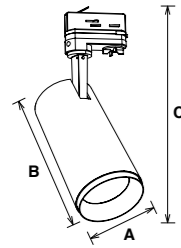

JTL228 anti-glare track light is with high lumen COB chip and PMMA lens offer an uniform lighting output, flicker free internal driver and AL6063 aluminium lamp body to ensure excellent heat dissipation. Modular lens design for different beam angle and convenient maintenance.

- ▶ 24° 30° 36° 45°
- ▶ 60° 350° 90°
- ▶ IP20
- ▶ DIM Smart Lighting
- ▶ AC 200-240V PF ≥ 0.9 CRI ≥ 80 CRI ≥ 90 CRI ≥ 97
- ▶ SAA RoHS CE CB

Code	Watt	Size(AxBxCmm)	Lumen(±5%)	N.W/pc(kgs)	Q'ty/CTN
JTL228-10W	10W	Ø65x157x249	1100lm	0.50	12PCS
JTL228-15W	15W	Ø65x157x249(Non-dim) Ø85x178x269 (Triac- dim)	1500lm	0.50	12PCS
JTL228-20W	20W	Ø85x178x269	2250lm	0.76	12PCS
JTL228-25W	25W	Ø85x178x269	2700lm	0.76	12PCS
JTL228-30W	30W	Ø100x211x302	3050lm	1.10	12PCS
JTL228-40W	40W	Ø100x211x302	4200lm	1.10	12PCS

CCT ——— 2700K 3000K 4000K 5000K      Finish ——— White Black Silver

Interchangeable lens options ——— 24°/30°/45° for 10W/15W      24°/36°/60° for 15W/20W/25W/30W/40W

# 228 Series

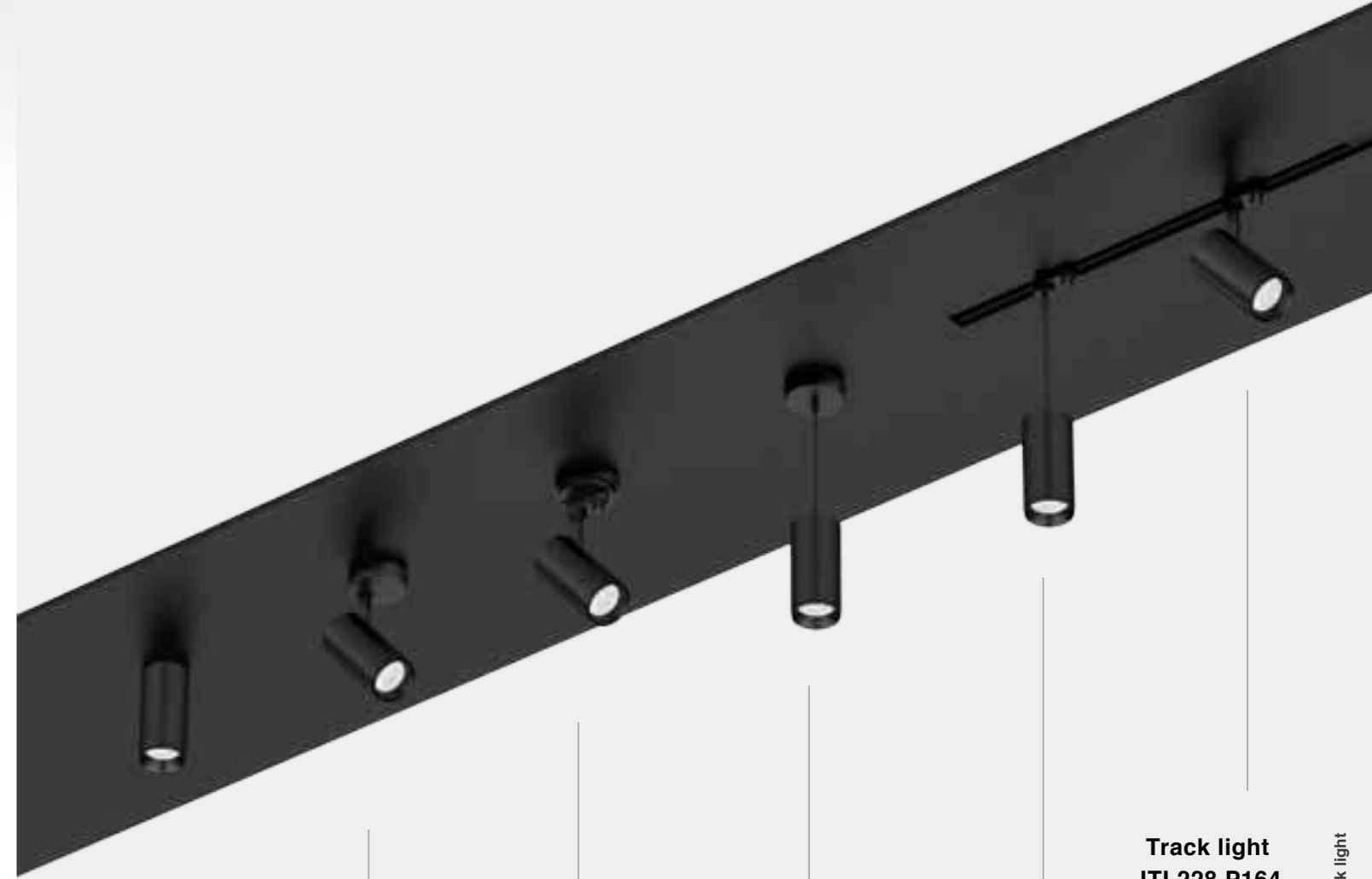

Track light JTL228 P164

Suspension JPD228B

Suspension JPD228 P126

JTL228 with ceiling box

Track spot surface JDL228B P125

Surface mounted JDL228A P124

LED Track light



**JTL29A/C**



**JTL29B/D**



**JTL29E**



**JTL29F**

## **JTL29 Track Light /Series/**

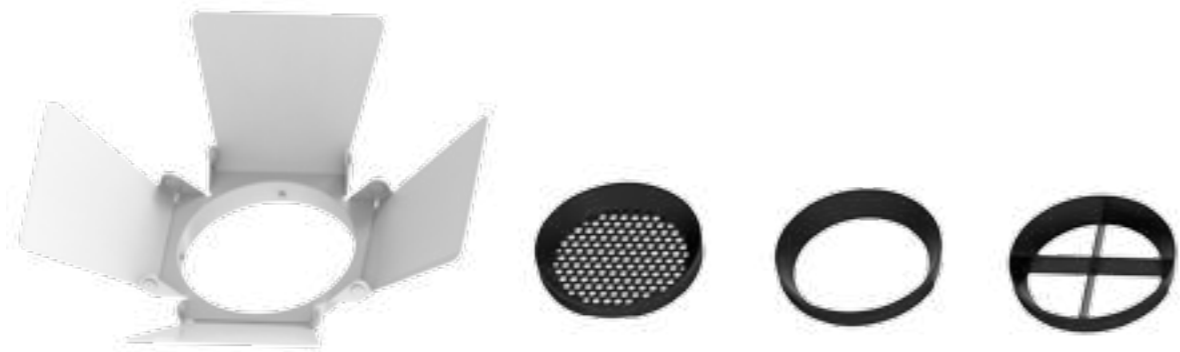



# JTL29A Track light

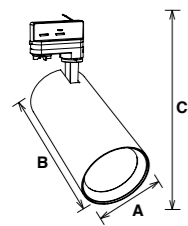

JTL29A driverless track light adopts high quality brand DOB led light source, anti-glare PMMA lens with great lighting distribution, superior 6063 aluminum heat sink with great heat dissipation.

- ▶ 15° 24° 36° 350° 90° IP20
- ▶ AC 220-240V CRI≥80 CRI≥90
- ▶ RoHS CE

Code	Watt	Size(AxBxCmm)	Lumen(±5%)	N.W/pc(kgs)	Q'ty/CTN
JTL29A-20W	20W	Ø85x170x261	1560lm	0.55	12PCS
JTL29A-30W	30W	Ø100x200x291	2550lm	0.79	12PCS
JTL29A-40W	40W	Ø100x200x291	3400lm	0.79	12PCS

CCT — 2700K 3000K 4000K 5000K

Finish — White Black Silver

Trim Accessories — Barn Door Honeycomb Louver Standard Cross Louver



# JTL29B Track light

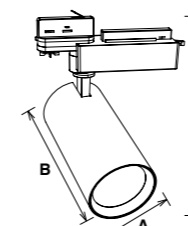

JTL29B track light adopts brand Citizen COB led chip with CRI80 CRI90 CRI97 for options and AL6063 superior housing to support excellent heat dissipation. Brand Trodonic Driver available, also could be for Fresh Lighting.

- ▶ 15° 24° 36° 350° 90° IP20
- ▶ DIM Vivid Lighting
- ▶ AC 220-240V CRI≥80 CRI≥90 CRI≥97
- ▶ SAA RoHS CE

Code	Watt	Size(AxBxCmm)	Lumen(±5%)	N.W/pc(kgs)	Q'ty/CTN
JTL29B-12W	12W	Ø65x150x188	1200lm	0.52	12PCS
JTL29B-25W	25W	Ø85x170x206	2750lm	0.75	12PCS
JTL29B-35W	35W	Ø85x200x206	3675lm	0.79	12PCS
JTL29B-42W	42W	Ø100x200x220	4410lm	1.05	12PCS

CCT — 2700K 3000K 4000K 5000K

Finish — White Black Silver

Trim Accessories — Barn Door Honeycomb Louver Standard Cross Louver



# JTL29C Track light

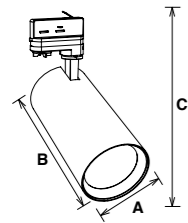

JTL29C track light adopts brand Citizen COB led chip, internal driver and superior AL6063 aluminium housing with excellent heat dissipation, Standard, honeycomb, shutter different trims for options.

- ▶ 15° 24° 36° 350° 90° IP20
- ▶ DIM
- ▶ AC 220-240V CRI≥80 CRI≥90
- ▶ SAA RoHS CE

Code	Watt	Size(AxBxCmm)	Lumen(±5%)	N.W/pc(kgs)	Q'ty/CTN
JTL29C-12W	12W	Ø65x150x243	1200lm	0.47	12PCS
JTL29C-25W	25W	Ø85x200x291	2750lm	0.68	12PCS
JTL29C-35W	35W	Ø100x200x291	3675lm	0.79	12PCS

CCT — 2700K 3000K 4000K 5000K

Finish — White Black Silver

Trim Accessories — Barn Door Honeycomb Louver Standard Cross Louver



# JTL29D Track light

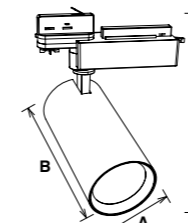

JTL29D led track light is with minimalist design structure with external driver, 4 types reflectors and trim for option. It adopts high lumen SMD LED, anti-glare PC lens with great lighting distribution. Supreme 6063 aluminum heat sink provides great heat dissipation.

- ▶ 38° 350° 90° IP20
- ▶ SLIDE SWITCH 3 in 1
- ▶ AC 220-240V CRI≥80
- ▶ SAA RoHS CE

Code	Watt	Size(AxBxCmm)	Lumen(±5%)	N.W/pc(kgs)	Q'ty/CTN
JTL29D-20W-C3	20W	Ø85x170x206	1800lm	0.75	12PCS
JTL29D-30W-C3	30W	Ø85x200x206	2600lm	0.79	12PCS

CCT — 3000K 4000K 5700K

Finish — White Black Silver

Trim Accessories — Barn Door Honeycomb Louver Standard Cross Louver



# JTL29E Track light

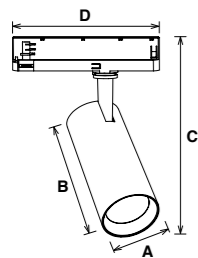

JTL29E led track light is with minimalist design structure, Integrated designed of driver and adapter make the lamp with more unique appearance and longer lifespan. It adopts anti-glare PC lens with great lighting distribution and brand Citizen cob led light source. Supreme 6063 aluminum heat sink provides great heat dissipation.

- ▶ 15° 24° 36° 350° 90° IP20
- ▶ AC 220-240V CRI≥80 CRI≥90 CRI≥97
- ▶ RoHS CE

Code	Watt	Size(AxBxCxDmm)	Lumen(±5%)	N.W/pc(kgs)	Q'ty/CTN
JTL29E-25W	25W	Ø85x170x258x198	2750lm	0.65	12PCS
JTL29E-35W	35W	Ø85x200x288x198	3675lm	0.68	12PCS

CCT ——— 2700K 3000K 4000K 5000K      Finish ——— White Black Silver

Trim Accessories ——— Barn Door Honeycomb Louver Standard Cross Louver



# JTL29F Track light

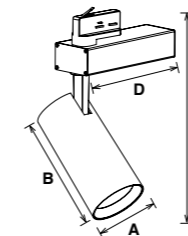

JTL29F led track light is with minimalist design structure with external driver, 4 types reflectors and trim for option. It adopts anti-glare PC lens with great lighting distribution and brand Citizen cob led light source. Supreme 6063 aluminum heat sink provides great heat dissipation. Tridonic DALI solution and Citizen chip ensure reliable quality.

- ▶ 15° 24° 36° 350° 90° IP20
- ▶ DALI
- ▶ AC 220-240V CRI≥80 CRI≥90 CRI≥97
- ▶ RoHS CE

Code	Watt	Size(AxBxCxDmm)	Lumen(±5%)	N.W/pc(kgs)	Q'ty/CTN
JTL29F-25W	25W	Ø85x170x298x198	2610lm	0.90	12PCS
JTL29F-35W	35W	Ø85x200x328x198	3490lm	0.95	12PCS
JTL29F-42W	42W	Ø100x200x328x198	4110lm	1.20	12PCS

CCT ——— 2700K 3000K 4000K 5000K      Finish ——— White Black Silver

Trim Accessories ——— Barn Door Honeycomb Louver Standard Cross Louver



# JTL69A Track light

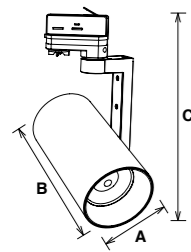

JTL69 series track light with adjustable focus design, special lens can have a fast beam angle change (Just press the lens). Adopt high lumen Citizen light source, two bracket design options, changeable lighting orientation with 350° in horizontal direction and 300° in vertical direction.

- ▶ IP20
- ▶ DIM
- ▶ AC 200-240V PF≥0.9 CRI≥80
- ▶ RoHS CE

Code	Watt	Size(AxBxCmm)	Lumen(±5%)	N.W/pc(kgs)	Q'ty/CTN
JTL69A-25W	25W	Ø96x180.5x298	2950lm	1.20	12PCS
JTL69A-35W	35W	Ø96x180.5x298	3950lm	1.20	12PCS



# JTL69B Track light

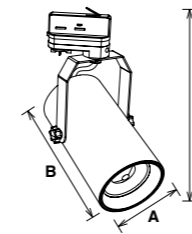

JTL69B track light is with special design with lens changeable 36°~60°by press . Adopt high lumen Citizen light source effected 115lm/w. Aluminum heat sink provides excellent heat dissipation. Black and white finish color for option.

- ▶ IP20
- ▶ DIM
- ▶ AC 200-240V PF≥0.9 CRI≥80
- ▶ RoHS CE

Code	Watt	Size(AxBxCmm)	Lumen(±5%)	N.W/pc(kgs)	Q'ty/CTN
JTL69B-25W	25W	Ø96x180.5x298	2950lm	1.20	12PCS
JTL69B-35W	35W	Ø96x180.5x298	3950lm	1.20	12PCS



# JTL57A Track light

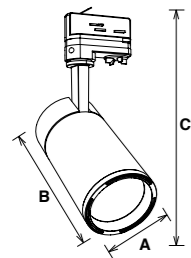

JTL57A led track light is with minimalist design structure with built-in driver, it adopts brand Citizen COB chip. Supreme Aluminum heat sink provides great heat dissipation. Secondary optics with lens and reflector make more uniform light.

- ▶ 15° 24° 36° 350° 90° IP20
- ▶ AC 220-240V PF≥0.9 CRI≥80 CRI≥90
- ▶ SAA RoHS CE CB

Code	Watt	Size(AxBxCmm)	Lumen(±5%)	N.W/pc(kgs)	Q'ty/CTN
JTL57A-15W	15W	Ø65x127x223	1750lm	0.51	12PCS
JTL57A-25W	25W	Ø80x157x254	2850lm	0.81	12PCS
JTL57A-35W	35W	Ø100x167x259	4000lm	1.03	12PCS

CCT — 2700K 3000K 4000K 5000K Finish — White Black Silver



# JTL58A Track light

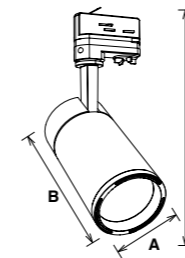

JTL58A LED track light with internal driver adopts CITIZEN chips with high quality LED source, CRI80/90/97 optional. Secondary optics with lens make more uniform light. Integrated die-cast aluminum and thermal convection design provide excellent heat dissipation.

- ▶ 15° 24° 36° 350° 90° IP20
- ▶ AC 200-240V PF≥0.9 CRI≥80 CRI≥90
- ▶ SAA RoHS CE CB

Code	Watt	Size(AxBxCmm)	Lumen(±5%)	N.W/pc(kgs)	Q'ty/CTN
JTL58A-15W	15W	Ø65x131x 227	1650lm	0.52	12PCS
JTL58A-25W	25W	Ø80x152.5x249	2750lm	0.82	12PCS
JTL58A-35W	35W	Ø100x167x259	3850lm	1.10	12PCS

CCT — 2700K 3000K 4000K 5000K Finish — White Black Silver



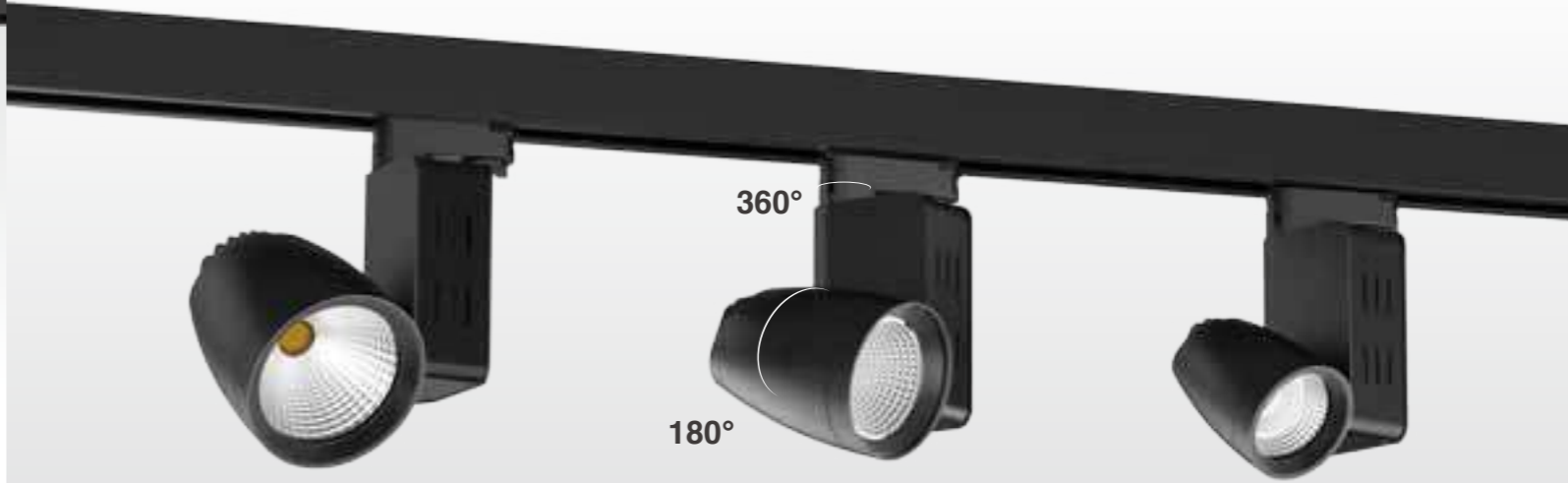

# JTL02 Track light

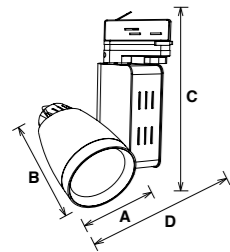

JTL02 LED track light with internal driver adopts CREE/CITIZEN branded chips, providing adjustable lighting orientation with 360 degree in horizontal direction and 180 in vertical direction.

- ▶ 15° 24° 30° 45° 60° IP20
- ▶ AC 100-240V PF≥0.9 CRI≥80 CRI≥90
- ▶ SAA RoHS CE TUV

Code	Watt	Size(AxBxCxDmm)	Lumen(±5%)	N.W/pc(kgs)	Q'ty/CTN
JTL02-12W	12W	Ø75x104x220x126.5	1380lm	0.70	12PCS
JTL02-25W	25W	Ø90x121x233x141	2500lm	1.17	12PCS
JTL02-35W	35W	Ø110x131x234x161	3600lm	1.30	8PCS
JTL02-45W	45W	Ø110x131x234x161	4380lm	1.30	8PCS

15° 24° 45° 60°

## JTL02 TRACK LIGHT

Excellent heat dissipation even light output without glare & dark spot

CCT — 2700K 3000K 4000K 5000K Finish — White Black Silver



# JTL25 Track light

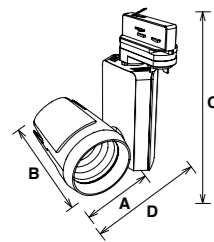

JTL25 LED track light with dimming button on the bottom of the track light adopts CITIZEN LED, adjustable lighting orientation with 360 degree in horizontal direction and 180 in vertical direction, 1-circuit adapter, 3-circuit adapter available for wide choice.

- ▶ 15° 24° 36° 45°
- ▶ 360° 180°
- ▶ IP20
- ▶ DIM
- ▶ AC 220-240V CRI $\geq$ 80 CRI $\geq$ 90
- ▶ SAA RoHS CE

Code	Watt	Size(AxBxCxDmm)	Lumen(±5%)	N.W/pc(kgs)	Q'ty/CTN
JTL25-15W	15W	Ø68x83x170x102	1470lm	0.38	18PCS
JTL25-25W	25W	Ø90x118.5x215x146	2600lm	0.68	12PCS
JTL25-35W	35W	Ø105x128x215x161	3600lm	0.85	12PCS
JTL25-45W	45W	Ø105x128x215x161	4410lm	0.85	12PCS

CCT ——— 2700K 3000K 4000K 5000K      Finish ——— White Black Silver

Dimming button (100% down to 5%) ———



# JTL25B Track light

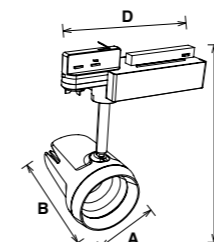

JTL25B LED track light adopts CITIZEN LED, adjustable lighting orientation with 360 degree in horizontal direction and 180 in vertical direction and 1-circuit adapter, 3-circuit adapter available for wide choice.

- ▶ 15° 24° 36°
- ▶ 360° 180°
- ▶ IP20
- ▶ AC 220-240V CRI $\geq$ 80 CRI $\geq$ 90
- ▶ SAA RoHS CE

Code	Watt	Size(AxBxCxDmm)	Lumen(±5%)	N.W/pc(kgs)	Q'ty/CTN
JTL25B-25W	25W	Ø90x118x247x207	2600lm	0.75	12PCS
JTL25B-35W	35W	Ø105x128x262x207	3600lm	0.92	12PCS
JTL25B-45W	45W	Ø105x128x262x207	4410lm	0.92	12PCS

CCT ——— 2700K 3000K 4000K 5000K      Finish ——— White Black Silver



# JTL56 Track light

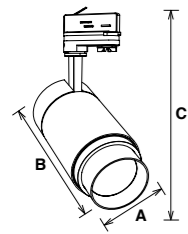

JTL56 LED track light is a unique beam angle adjustable(15°-60°) design, adopt high lumen CITIZEN COB chip, flicker-free driver. Dimmable is available. Aluminum housing and cross-ventilated design ensure a excellent heat management.

- ▶ 15°-60° 350° 90° IP20
- ▶ DIM
- ▶ AC 220-240V PF≥0.9 CRI≥80 CRI≥90 CRI≥97
- ▶ SAA RoHS CE CB TUV

Code	Watt	Size(AxBxCmm)	Lumen(±5%)	N.W/pc(kgs)	Q'ty/CTN
JTL56-15W	15W	Ø65x137x234	1500lm	0.69	12PCS
JTL56-25W	25W	Ø80x163x260	2500lm	0.91	12PCS
JTL56-30W	30W	Ø100x173x265	3000lm	1.29	12PCS

CCT — 2700K 3000K 4000K 5000K Finish — White Black Silver



# JTL17 Track light

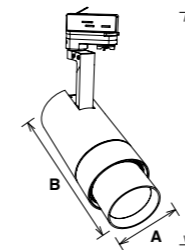

By using advancing zooming technology, JTL17 LED tracklight have a flexible beam angle from 10° to 60°. Flicker free LED driver. Dimmable for option.

- ▶ 10°-60° 320° 90° IP20
- ▶ DIM
- ▶ AC 200-240V PF≥0.9 CRI≥80 CRI≥90
- ▶ SAA RoHS CE

Code	Watt	Size(AxBxCmm)	Lumen(±5%)	N.W/pc(kgs)	Q'ty/CTN
JTL17-35W	35W	Ø100x207x301	1790~3720lm	1.53	6PCS

CCT — 2700K 3000K 4000K 5000K Finish — White Black Silver



# JTL45 Track light

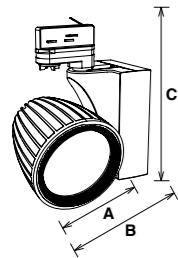

- ▶ 20° 45° 350° 180° IP20
- ▶ AC 200-240V CRI ≥ 80
- ▶ RoHS CE

JTL45 high power LED tracklight with large Alumium heat sink, ensure great dissipation, Adopting CITIZEN COB and built-in flicker-free driver ensure the excellet lighting performance. Ineterchangeable reflector 20°/45° helps reduce stock level.

Code	Watt	Size(AxBxCmm)	Lumen(±5%)	N.W/pc(kgs)	Q'ty/CTN
JTL45-40W	40W	Ø132.5x248x189.5	4080lm	1.45	8PCS
JTL45-50W	50W	Ø132.5x248x189.5	5000lm	1.45	8PCS

CCT ——— 2700K 3000K 4000K 5000K      Finish ——— White Black Silver



LED Track light



# JTL79 Track light

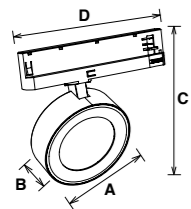

JTL79 track light is an integrated design with internal driver and 3 circuit adapter. It is with interchangeable lens 15°/24°/36°/60° and Replaceable rings Black/White/Gold/Silver.

- ▶ 15° 24° 36° 60° IP20
- ▶ AC 200-240V CRI≥80
- ▶ RoHS CE

Code	Watt	Size(AxBxCxDmm)	Lumen(±5%)	N.W/pc(kgs)	Q'ty/CTN
JTL79-25W	25W	Ø120x43x178x207	2950lm	0.61	12PCS
JTL79-30W	30W	Ø120x43x178x207	3350lm	0.61	12PCS



## INTERCHANGEABLE lens and trim

CCT — 2700K 3000K 4000K 5000K Trim — White Black Silver Golden



# JTL40A Track light

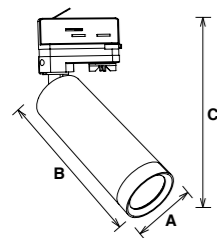

JTL40A LED tracklight with lens interchangeable design, provide 8 types beam angle options. The slim body plus CREE COB chip and non-dim/triac dim driver, giving great performance for accent lighting.

- ▶ 25° 10°x25° 25°x25° 25°x36° 36°
- ▶ 4°x36° 10°x36° 36°x36° 350° 90° IP20
- ▶ DIM
- ▶ AC 220-240V CRI≥80
- ▶ RoHS CE

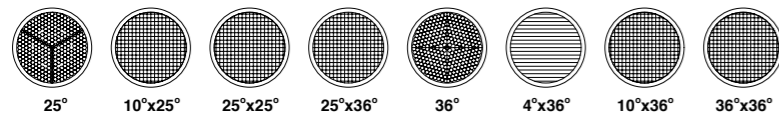

Code	Watt	Size(AxBxCmm)	Lumen(±5%)	N.W/pc(kgs)	Q'ty/CTN
JTL40A-7W	7W	Ø54x156x230	550lm	0.45	24PCS
JTL40A-10W	10W	Ø54x156x230	740lm	0.45	24PCS

CCT — 3000K 4000K 5000K 5700K Finish — White Black Silver



# JTL40B Track light

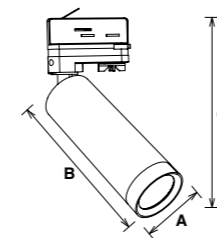

JTL40B led track light adopts Citizen chip which can create a diversified and dramatic atmosphere. Adjustable lighting orientation with 350° in horizontal direction and 90° in vertical direction will bring a flexible exposure. 1-circuit and 3-circuit are all available.

- ▶ 15° 24° 36° 350° 90° IP20
- ▶ DIM
- ▶ AC 220-240V CRI≥80
- ▶ RoHS CE

Code	Watt	Size(AxBxCmm)	Lumen(±5%)	N.W/pc(kgs)	Q'ty/CTN
JTL40B-10W	10W	Ø54x162x236	1000lm	0.45	24PCS
JTL40B-12W	12W	Ø54x162x236	1200lm	0.45	24PCS

CCT — 2700K 3000K 4000K 5000K Finish — White Black Silver



# JTL62 Track light

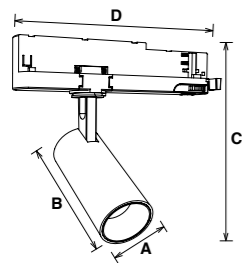

JTL62 LED track light with simple structure design. Integrate driver and 3 circuits adapter. Adopt Cree LED and lens for accent lighting. ADC12 aluminum light body provides excellent heat dissipation. Adjustable lighting orientation with 350° in horizontal direction and 90° in vertical direction.

- ▶ 36° 350° 180° IP20
- ▶ AC 220-240V PF≥0.9 CRI≥80
- ▶ SAA RoHS CE

Code	Watt	Size(AxBxCxDmm)	Lumen(±5%)	N.W/pc(kgs)	Q'ty/CTN
JTL62-8W	8W	Ø46x100x180x196	600lm	0.27	30PCS
JTL62-12W	12W	Ø46x120x200x196	880lm	0.30	30PCS
JTL62-16W	16W	Ø46x120x200x196	1080lm	0.30	30PCS

CCT — 2700K 3000K 4000K 5000K Finish — White Black Silver



# JTL16 Track light

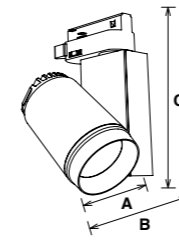

JTL16 patent mini track lights with high CRI high lumen CITIZEN COB led chip to enhance color fidelity target illumination object. both non-dimmable and triac dimmable can be available, triac dimmable can be compatible with global brand dimmer.

- ▶ 15° 24° 36° 60°
- ▶ AC 100-240V PF≥0.9 CRI≥80
- ▶ SAA RoHS CE
- ▶ DIM
- ▶ 360° 180° IP20

Code	Watt	Size(AxBxCmm)	Lumen(±5%)	N.W/pc(kgs)	Q'ty/CTN
JTL16-12W	12W	Ø62x100x182	1350lm	0.46	20PCS

CCT — 2700K 3000K 4000K 5000K Finish — White Black Silver



# JTL49 Track light

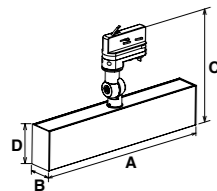

JTL49 LED linear track light with louver reflector design. it's widely used as additional lighting compared with traditional spot track light. Adopt 2835SMD chip, louver reflector make it anti-glare, 6063 aluminum provides good heat dissipation. Adjustable lighting orientation with 350° in horizontal direction and 220° in vertical direction.

- ▶ 60°
- ▶ 350°
- ▶ 220°
- ▶ IP20
- ▶ UGR<19
- ▶ AC 220-240V
- ▶ PF≥0.9
- ▶ CRI≥80
- ▶ RoHS
- ▶ CE

Code	Watt	Size(AxBxCxDmm)	Lumen(±5%)	N.W/pc(kgs)	Q'ty/CTN
JTL49-15W	15W	319.5x42x195.5x70	1400lm	0.74	12PCS
JTL49-30W	30W	424.5x42x195.5x70	2750lm	0.92	12PCS
JTL49-37W	37W	529.5x42x195.5x70	3400lm	1.15	12PCS
JTL49-45W	45W	529.5x42x195.5x70	3850lm	1.15	12PCS

CCT — 3000K 4000K 5000K 5700K      Finish — White Black Silver



# JTL50/B Track light

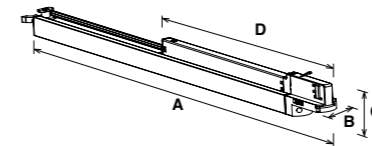

JTL50 LED linear track light is a concise design with internal flicker free led driver. Adopting high lumen efficiency SMD LED. Aluminum lamp body and reflector provide excellent heat management. Interchangeable CCT with slide switch is available.

- ▶ 110°
- ▶ IP20
- ▶ SLIDE SWITCH 3 in 1
- ▶ AC 220-240V
- ▶ PF≥0.9
- ▶ CRI≥80
- ▶ SAA
- ▶ RoHS
- ▶ CE

Code	Watt	Size(AxBxCxDmm)	Lumen(±5%)	N.W/pc(kgs)	Q'ty/CTN
JTL50/B-10W	10W	650x32.5x52x436	1000lm	0.43	12PCS
JTL50/B-16W	16W	650x32.5x52x436	1560lm	0.45	12PCS
JTL50/B-25W	25W	1212x32.5x52x496	2550lm	0.76	12PCS
JTL50/B-30W	30W	1212x32.5x52x496	3000lm	0.76	12PCS
JTL50/B-30W	30W	1493x32.5x52x496	3000lm	0.92	12PCS

CCT — 3000K 4000K 5000K 5700K      Finish — White Black Silver



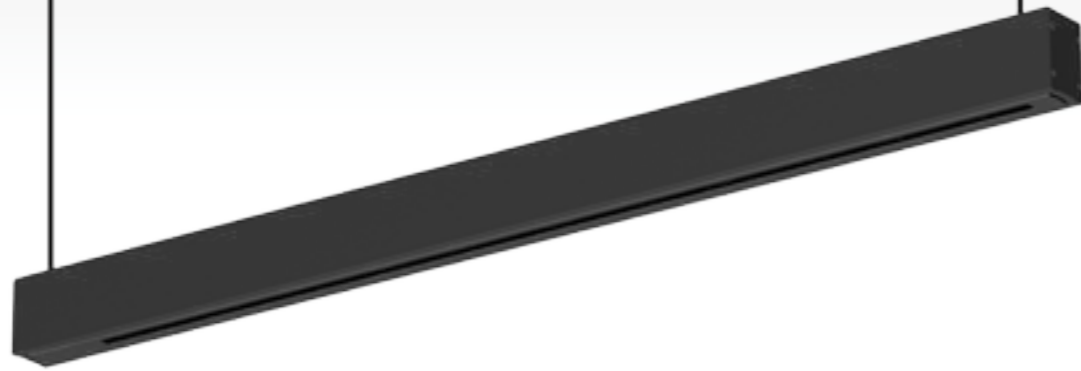

# JDB38 Linear light

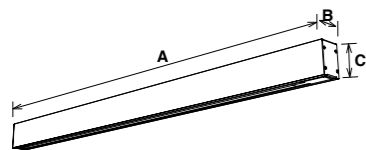

JDB38 is a unique double-side design batten track light. Upper side with standard light, under side with additional track light. Adopts Global track bar and built-in flicker free 0/1-10V driver solution. Splicing connection is available.

- ▶
- ▶
- ▶

Code	Watt	Size(AxBxCmm)	Lumen(±5%)	N.W/pc(kgs)	Q'ty/CTN
JDB38-600-20W	20W	575x50x76	1800lm	1.98	6PCS
JDB38-1200-38W	38W	1075x50x76	3600lm	2.92	6PCS

CCT — 3000K 4000K 5000K 5700K      Finish — White Black Silver

Splicing

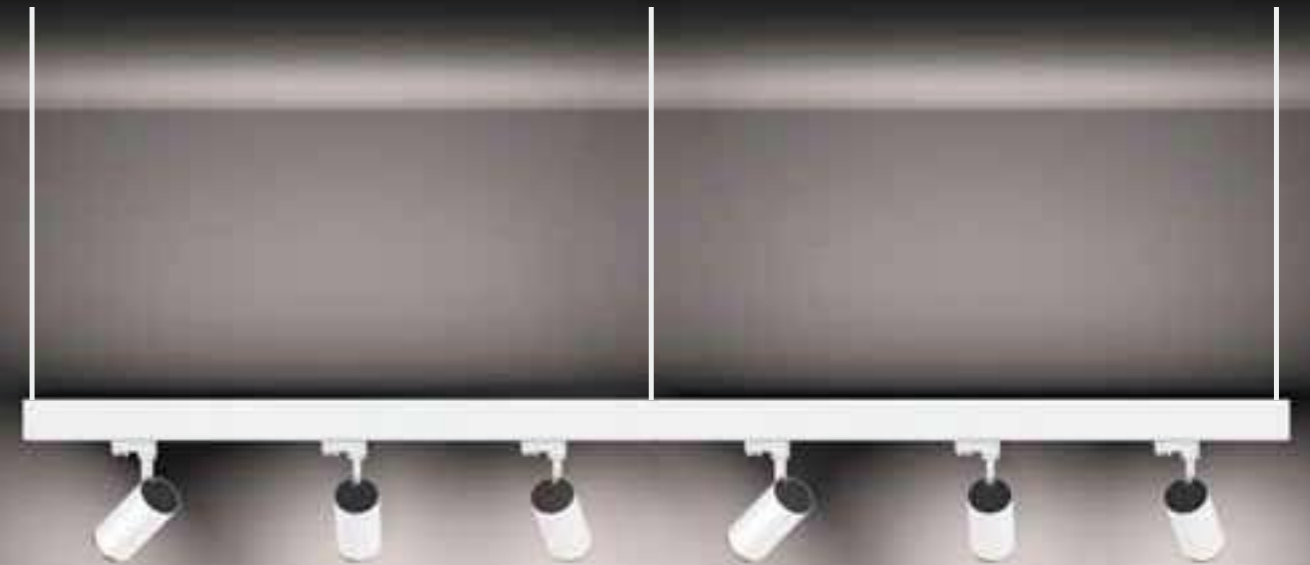

LED Track light

## DOUBLE-SIDED LAMP

upper side with standard light, under side with additional track light



# JTL04 Track light

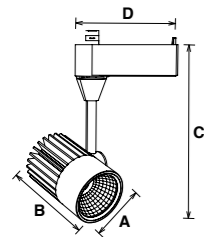

JTL04 adopts high efficient reflector and COB LED chip. Dimmable available for wide choice, surface mounted and embedded installation provided for all possible installation situations.

- ▶ 24° 36° IP20
- ▶ DIM
- ▶ AC 200-240V PF≥0.9 CRI≥80
- ▶ SAA RoHS CE

Code	Watt	Size(AxBxCxDmm)	Lumen(±5%)	N.W/pc(kgs)	Q'ty/CTN
JTL04-10W	10W	Ø55x85x162x102	1040lm	0.31	30PCS

CCT — 2700K 3000K 4000K 5000K Finish — White Black Silver



# JTL04B Track light

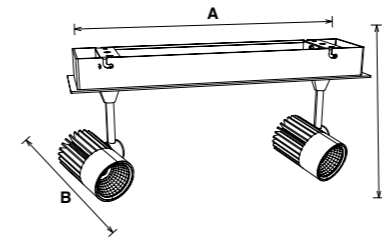

JTL04B adopts high efficient reflector and COB LED chip. Dimmable available for wide choice, surface mounted installation provided a wide application.

- ▶ 36° IP20
- ▶ DIM
- ▶ AC 200-240V PF≥0.9 CRI≥80
- ▶ RoHS CE



Code	Watt	Size(AxBxCmm)	Lumen(±5%)	N.W/pc(kgs)	Q'ty/CTN
JTL04B-10WJ	10W	111x107x156	1040lm	0.50	20PCS
JTL04B-2x10W	20W	395x107x156	2080lm	1.20	8PCS
JTL04B-3x10W	30W	625x107x156	3120lm	1.80	6PCS
JTL04B-4x10W	40W	855x107x156	4160lm	2.40	4PCS
JTL04B-4x10W(S)	40W	295x291x156	4160lm	2.10	4PCS

CCT — 2700K 3000K 4000K 5000K Finish — White Black Silver



# JTL13/B Track light

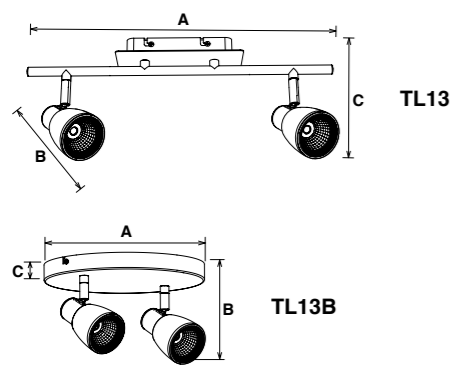

JTL13 ceiling spotlight adopts die-casting ADC12 with excellent heat management. Dimmable available, surface mounted installation provided a wide application. Adjustable lighting orientation with 350 degree in horizontal direction and 35 in vertical direction provided

- ▶ IP20
- ▶ DIM
- ▶ 

AC 100-240V	AC 200-240V	PF≥0.9	CRI≥80
-------------	-------------	--------	--------
- ▶ 

SAA	RoHS	CE
-----	------	----



Code	Watt	Size(AxBxCmm)	Lumen(±5%)	N.W/pc(kgs)	Q'ty/CTN
JTL13-10W	10W	204x117.5x148	800lm	0.70	12PCS
JTL13-20W	20W	449x117.5x148	1600lm	1.00	6PCS
JTL13-30W	30W	774x117.5x148	2400lm	1.30	6PCS
JTL13B-10W	10W	Ø80x161x25	800lm	0.32	24PCS
JTL13B-20W	20W	Ø240x161x25	1600lm	0.93	12PCS
JTL13B-30W	30W	Ø240x161x25	2400lm	1.16	12PCS

CCT — 2700K 3000K 4000K 5000K Finish — White Black Silver



# JTL14 Track light

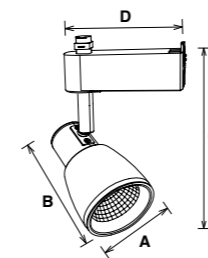

JTL14 ceiling spotlight adopts die-casting ADC12 with excellent heat management. Dimmable available for wide choice. Adjustable lighting orientation with 350 degree in horizontal direction and 35 in vertical direction provided.

- ▶ IP20
- ▶ DIM
- ▶ 

AC 200-240V	PF≥0.9	CRI≥80
-------------	--------	--------
- ▶ 

SAA	RoHS	CE
-----	------	----

Code	Watt	Size(AxBxCxDmm)	Lumen(±5%)	N.W/pc(kgs)	Q'ty/CTN
JTL14-10W	10W	Ø65x97.5x145x102	800lm	0.30	36PCS

CCT — 2700K 3000K 4000K 5000K Finish — White Black Silver



# JTL19 Track light

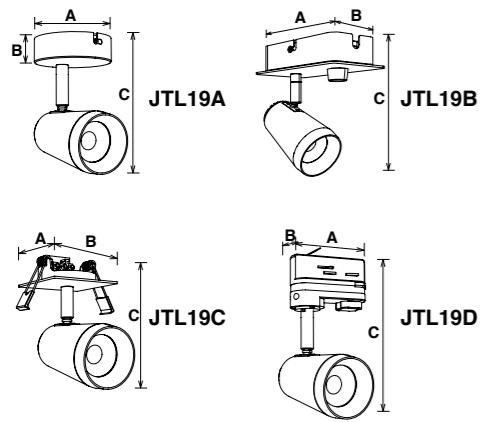

- ▶ 36° 60° IP20
- ▶ DIM
- ▶ 

AC 100-240V	AC 200-240V	PF≥0.9	CRI≥80
-------------	-------------	--------	--------
- ▶ 

SAA	RoHS	CE
-----	------	----

JTL19 surface mounred ceiling spotlight adopts die-casting ADC12 with excellent heat management. Dimmable available for wide choice. Adjustable lighting orientation with 350 degree in horizontal direction and 35 in vertical direction provided.

Code	Watt	Size(AxBxCmm)	Lumen(±5%)	N.W/pc(kgs)	Q'ty/CTN
JTL19A-10W	10W	Ø80x25x158	1055lm	0.28	24PCS
JTL19A-20W	20W	Ø240x25x158	2110lm	0.84	12PCS
JTL19A-30W	30W	Ø240x25x158	3165lm	1.02	12PCS
JTL19B-10W	10W	140x80x160	1055lm	0.48	24PCS
JTL19B-20W	20W	250x80x160	2110lm	0.90	12PCS
JTL19B-30W	30W	370x80x160	3165lm	1.28	12PCS
JTL19C-10W	10W	78x78x167	1055lm	0.28	24PCS
JTL19D-10W	10W	85x32x175	1055lm	0.28	24PCS

CCT ——— 2700K 3000K 4000K 5000K      Finish ——— White Black Silver



JTL19A                      JTL19B                      JTL19C                      JTL19D



JTL19A-10W                      JTL19A-20W                      JTL19A-30W



JTL19B-10W                      JTL19B-20W                      JTL19B-30W

LED Track light

# Track System

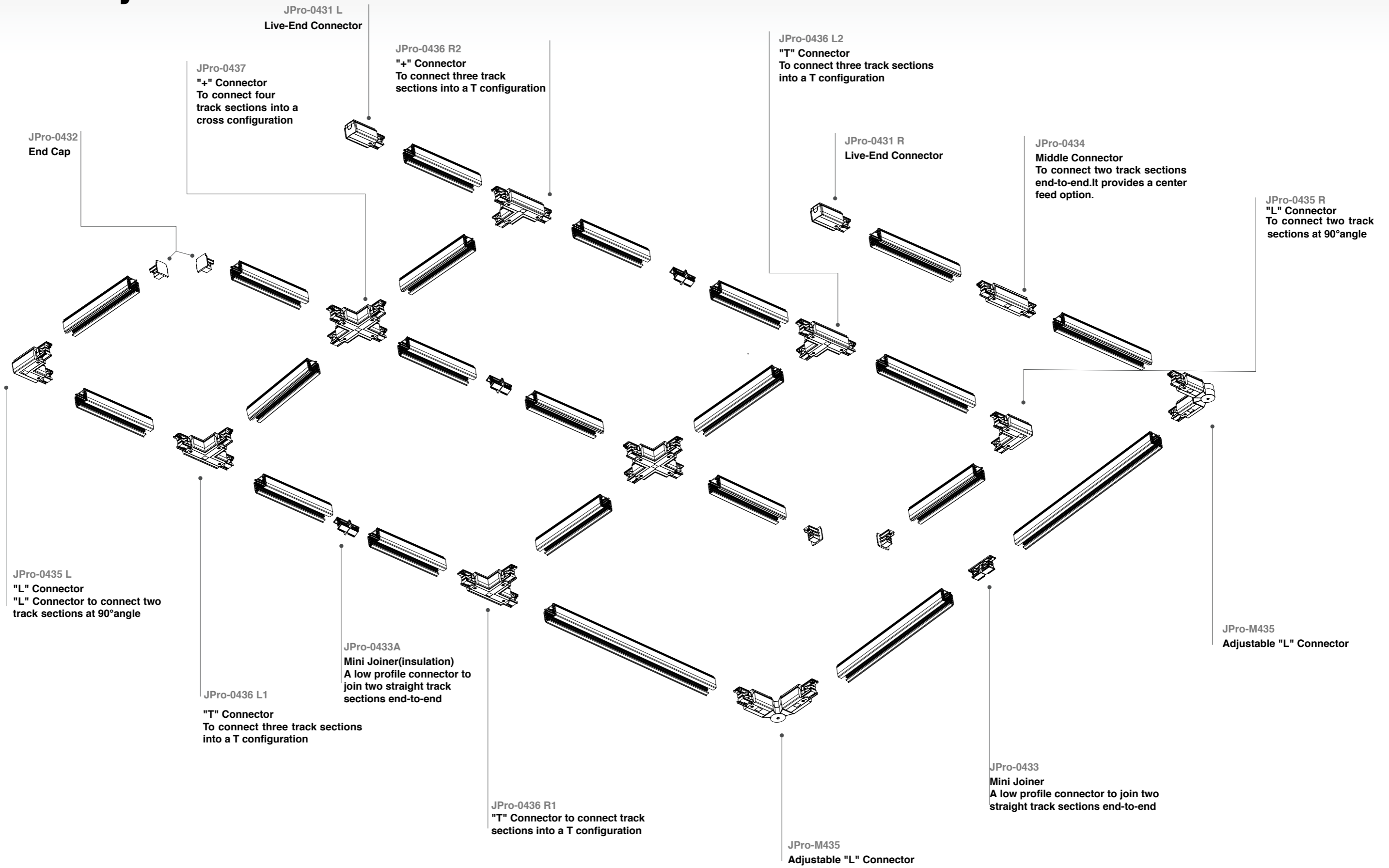

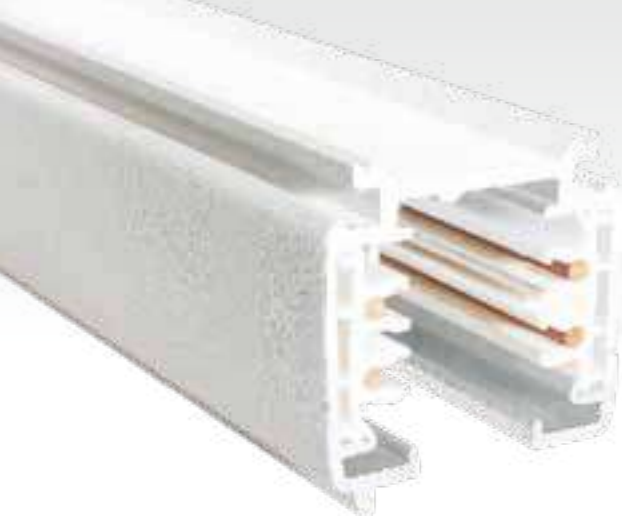

# 3 Circuits Track System

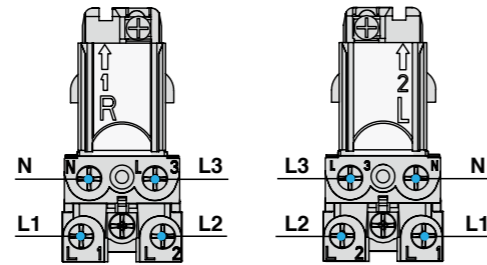
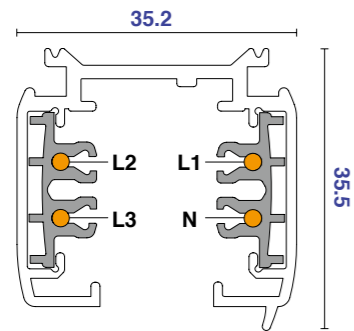

Model No.	Track length	Shell Material	Colour	Package
JPro-0410-W / Pro-0410-S / Pro-0410-B	1M track actual one meter.(100cm)	Aluminum Extrusion	White <input type="checkbox"/> Silver <input type="checkbox"/> Black <input type="checkbox"/>	1 / 12
JPro-0415-W / Pro-0415-S / Pro-0415-B	1.5M track actual one meter.(150cm)	Aluminum Extrusion	White <input type="checkbox"/> Silver <input type="checkbox"/> Black <input type="checkbox"/>	1 / 12
JPro-0420-W / Pro-0420-S / Pro-0420-B	2M track actual one meter.(200cm)	Aluminum Extrusion	White <input type="checkbox"/> Silver <input type="checkbox"/> Black <input type="checkbox"/>	1 / 12
JPro-0430-W / Pro-0430-S / Pro-0430-B	3M track actual one meter.(300cm)	Aluminum Extrusion	White <input type="checkbox"/> Silver <input type="checkbox"/> Black <input type="checkbox"/>	1 / 8
JPro-04400-W / Pro-04000-S / Pro-04000-B	4M track actual one meter.(400cm)	Aluminum Extrusion	White <input type="checkbox"/> Silver <input type="checkbox"/> Black <input type="checkbox"/>	1 / 6

## Live-End Connector



Model No.	Package	Colour
JPro-0431 L-W	1 / 150	White <input type="checkbox"/>
JPro-0431 L-S	1 / 150	Silver <input type="checkbox"/>
JPro-0431 L-B	1 / 150	Black <input type="checkbox"/>

## Live-End Connector



Model No.	Package	Colour
JPro-0431 R-W	1 / 150	White <input type="checkbox"/>
JPro-0431 R-S	1 / 150	Silver <input type="checkbox"/>
JPro-0431 R-B	1 / 150	Black <input type="checkbox"/>

## Mini Joiner



Model No.	Package	Colour
JPro-0433-W	1 / 400	White <input type="checkbox"/>
JPro-0433-S	1 / 400	Silver <input type="checkbox"/>
JPro-0433-B	1 / 400	Black <input type="checkbox"/>

## Mini Joiner(Insulation)

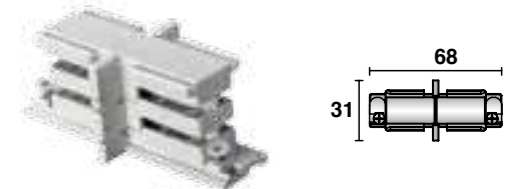

Model No.	Package	Colour
JPro-0433A-W	1 / 150	White <input type="checkbox"/>
JPro-0433A-S	1 / 150	Silver <input type="checkbox"/>
JPro-0433A-B	1 / 150	Black <input type="checkbox"/>

## End Cap



Model No.	Package	Colour
JPro-0432-W	1 / 500	White <input type="checkbox"/>
JPro-0432-S	1 / 500	Silver <input type="checkbox"/>
JPro-0432-B	1 / 500	Black <input type="checkbox"/>

## Mini Joiner(Insulation)

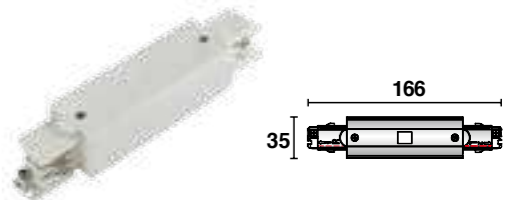

Model No.	Package	Colour
JPro-0434-W	1 / 150	White <input type="checkbox"/>
JPro-0434-S	1 / 150	Silver <input type="checkbox"/>
JPro-0434-B	1 / 150	Black <input type="checkbox"/>

Twisted "L" Connector



Model No.	Package	Colour
JPro-0438-W	1 / 154	White <input type="checkbox"/>
JPro-0438-S	1 / 154	Silver <input checked="" type="checkbox"/>
JPro-0438-B	1 / 154	Black <input type="checkbox"/>

"+" Connector



Model No.	Package	Colour
JPro-0437-W	1 / 60	White <input type="checkbox"/>
JPro-0437-S	1 / 60	Silver <input checked="" type="checkbox"/>
JPro-0437-B	1 / 60	Black <input type="checkbox"/>

Ceiling mount, EZCLIK suspension kit with ROD

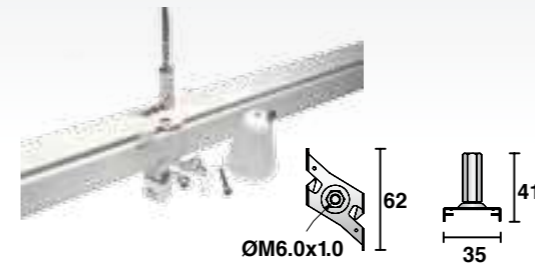

Model No.	Package	Colour
JPro-EZ0447-W	1 / 200	White <input type="checkbox"/>
JPro-EZ0447-S	1 / 200	Silver <input checked="" type="checkbox"/>
JPro-EZ0447-B	1 / 200	Black <input type="checkbox"/>

Ceiling mount, EZCLIK suspension kit with wire



Model No.	Package	Colour
JPro-EZ0448-W	1 / 200	White <input type="checkbox"/>
JPro-EZ0448-S	1 / 200	Silver <input checked="" type="checkbox"/>
JPro-EZ0448-B	1 / 200	Black <input type="checkbox"/>

Flexible Connector



Model No.	Package	Colour
JPro-0439-W	1 / 119	White <input type="checkbox"/>
JPro-0439-S	1 / 119	Silver <input checked="" type="checkbox"/>
JPro-0439-B	1 / 119	Black <input type="checkbox"/>

Adjustable "L" Connector

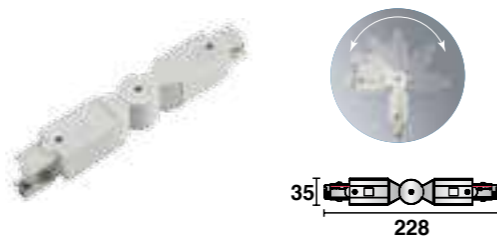

Model No.	Package	Colour
JPro-0435-W	1 / 119	White <input type="checkbox"/>
JPro-0435-S	1 / 119	Silver <input checked="" type="checkbox"/>
JPro-0435-B	1 / 119	Black <input type="checkbox"/>

T-Bar, EZCLIK mounting kit



Model No.	Package	Colour
JPro-M146T-W	1 / 500	White <input type="checkbox"/>
JPro-M146T-S	1 / 500	Silver <input checked="" type="checkbox"/>
JPro-M146T-B	1 / 500	Black <input type="checkbox"/>

Suspension Mounting Kits Manual

1) Adjust the EZCLICK Mounting Kit's Direction, put it vertically into the T-Bar ceiling, and then rotate right and fix (as picture shows).

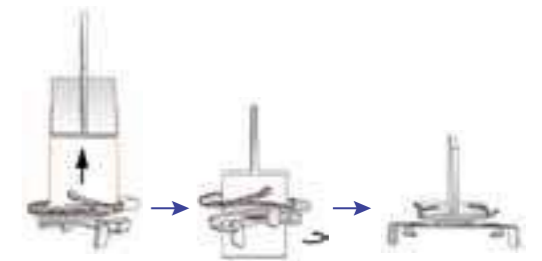

2) Adjust the EZCLICK Mounting Kit's Direction, put the track vertically into the EZCLICK Mounting Kit, rotate left and fix (like picture shows).

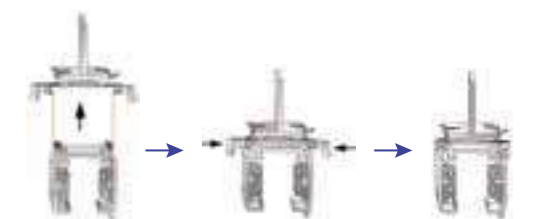

Twisted "T" Connector(Left)

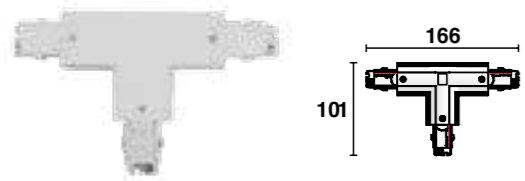

Model No.	Package	Colour
JPro-M436L-W	1 / 84	White <input type="checkbox"/>
JPro-M436L-S	1 / 84	Silver <input checked="" type="checkbox"/>
JPro-M436L-B	1 / 84	Black <input type="checkbox"/>

Twisted "T" Connector(Right)

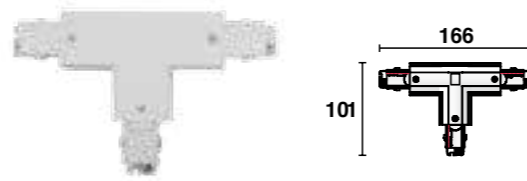

Model No.	Package	Colour
JPro-M436R-W	1 / 84	White <input type="checkbox"/>
JPro-M436R-S	1 / 84	Silver <input checked="" type="checkbox"/>
JPro-M436R-B	1 / 84	Black <input type="checkbox"/>

Ceiling Mount Reinforcement Plate with suspension wire

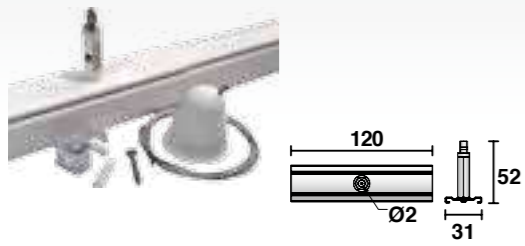

Model No.	Package	Colour
JPro-M147-W	1 / 200	White <input type="checkbox"/>
JPro-M147-S	1 / 200	Silver <input checked="" type="checkbox"/>
JPro-M147-B	1 / 200	Black <input type="checkbox"/>

Ceiling Mount Reinforcement Plate with suspension rod

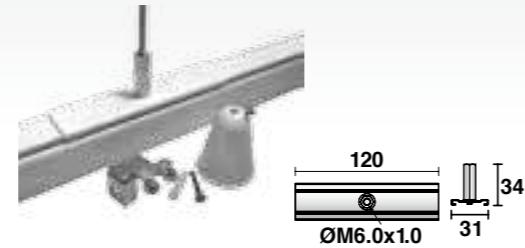

Model No.	Package	Colour
JPro-M148-W	1 / 200	White <input type="checkbox"/>
JPro-M148-S	1 / 200	Silver <input checked="" type="checkbox"/>
JPro-M148-B	1 / 200	Black <input type="checkbox"/>

T-Bar, EZCLIK with Reinforcement Plate

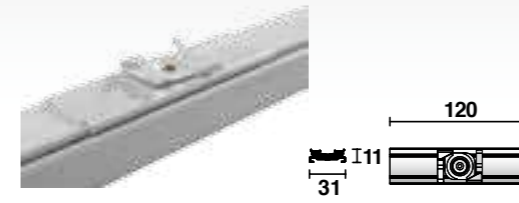

Model No.	Package	Colour
JPro-M149-W	1 / 200	White <input type="checkbox"/>
JPro-M149-S	1 / 200	Silver <input checked="" type="checkbox"/>
JPro-M149-B	1 / 200	Black <input type="checkbox"/>

Suspension Hook



Model No.	Package	Colour
JPro-M142-W	1 / 500	White <input type="checkbox"/>
JPro-M142-S	1 / 500	Silver <input checked="" type="checkbox"/>
JPro-M142-B	1 / 500	Black <input type="checkbox"/>

Suspension Mounting Kits Manual

1) Put the Track into the EZCLICK Mounting Kits Parallely (As picture shows).

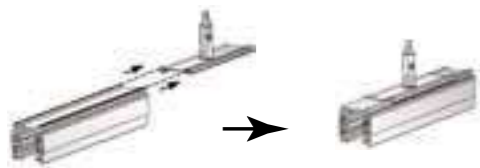

2) Release the start valve, press and get the wirerope through the EZCLICK Mounting Kit, rotate tight the start valve and lock the wirerope (like picture shows).

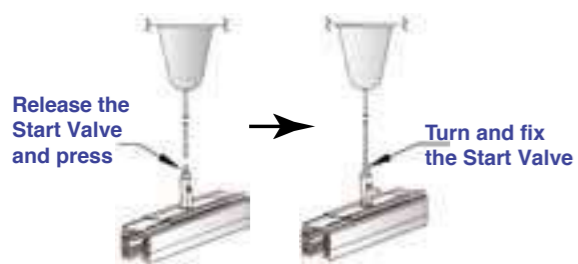

Suspension Mounting Kits Manual

1) Put the Track into the EZCLICK Kit Parallely (As picture shows).

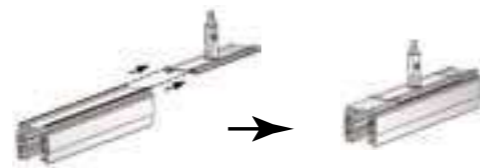

2) Rotate right the EZCLICK Kit and fix it on the rod.

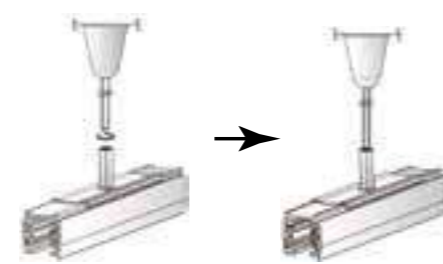

Suspension Mounting Kits Manual

1) Put the Track into the EZCLICK Mounting Kits parallely (As picture shows).

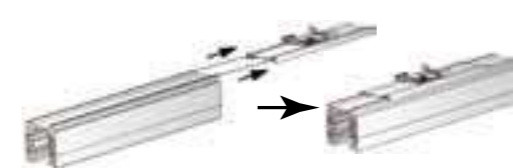

2) Adjust the EZCLICK Mounting Kit's direction, put the track vertically into the EZCLICK Mounting Kit, rotate right and fix (like picture shows).



Mechanical Adaptor



Model No.	Package	Colour
JPro-0449-W	1 / 100	White <input type="checkbox"/>
JPro-0449-S	1 / 100	Silver <input checked="" type="checkbox"/>
JPro-0449-B	1 / 100	Black <input type="checkbox"/>

Suspension kit



Model No.	Package	Colour
JPro-04SK-W	1 / 100	White <input type="checkbox"/>
JPro-04SK-S	1 / 100	Silver <input checked="" type="checkbox"/>
JPro-04SK-B	1 / 100	Black <input type="checkbox"/>





# 3 Circuits Recessed Track System

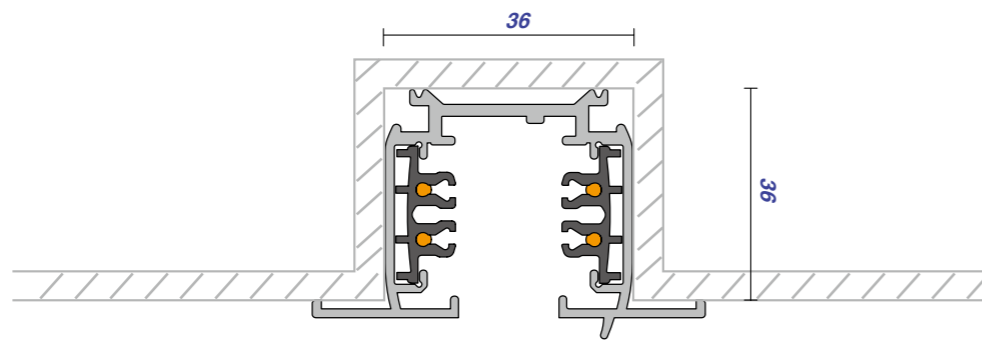
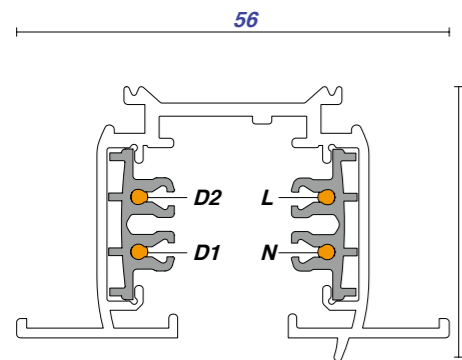

Model No.	Track length	Shell Material	Colour	Package
JPro-R410-W / Pro-R410-S / Pro-R410-B	1M track actual one meter.(100cm)	Aluminum Extrusion	White <input type="checkbox"/> Silver <input type="checkbox"/> Black <input type="checkbox"/>	1 / 9
JPro-R415-W / Pro-R415-S / Pro-R415-B	1.5M track actual one meter.(150cm)	Aluminum Extrusion	White <input type="checkbox"/> Silver <input type="checkbox"/> Black <input type="checkbox"/>	1 / 9
JPro-R420-W / Pro-R420-S / Pro-R420-B	2M track actual one meter.(200cm)	Aluminum Extrusion	White <input type="checkbox"/> Silver <input type="checkbox"/> Black <input type="checkbox"/>	1 / 9
JPro-R430-W / Pro-R430-S / Pro-R430-B	3M track actual one meter.(300cm)	Aluminum Extrusion	White <input type="checkbox"/> Silver <input type="checkbox"/> Black <input type="checkbox"/>	1 / 6
JPro-R4400-W / Pro-R4400-S / Pro-R4400-B	4M track actual one meter.(400cm)	Aluminum Extrusion	White <input type="checkbox"/> Silver <input type="checkbox"/> Black <input type="checkbox"/>	1 / 6

## Live-end Connector Cover



Model No.	Package	Colour
JPro-R431-W	1 / 500	White <input type="checkbox"/>
JPro-R431-S	1 / 500	Silver <input type="checkbox"/>
JPro-R431-B	1 / 500	Black <input type="checkbox"/>

## Live-End Connector



Model No.	Package	Colour
JPro-R434-W	1 / 400	White <input type="checkbox"/>
JPro-R434-S	1 / 400	Silver <input type="checkbox"/>
JPro-R434-B	1 / 400	Black <input type="checkbox"/>

## Mini Joiner



Model No.	Package	Colour
JPro-R435-W	1 / 400	White <input type="checkbox"/>
JPro-R435-S	1 / 400	Silver <input type="checkbox"/>
JPro-R435-B	1 / 400	Black <input type="checkbox"/>

## Mini Joiner(insulation)



Model No.	Package	Colour
JPro-R436-W	1 / 400	White <input type="checkbox"/>
JPro-R436-S	1 / 400	Silver <input type="checkbox"/>
JPro-R436-B	1 / 400	Black <input type="checkbox"/>

## End Cap



Model No.	Package	Colour
JPro-R437-W	1 / 400	White <input type="checkbox"/>
JPro-R437-S	1 / 400	Silver <input type="checkbox"/>
JPro-R437-B	1 / 400	Black <input type="checkbox"/>

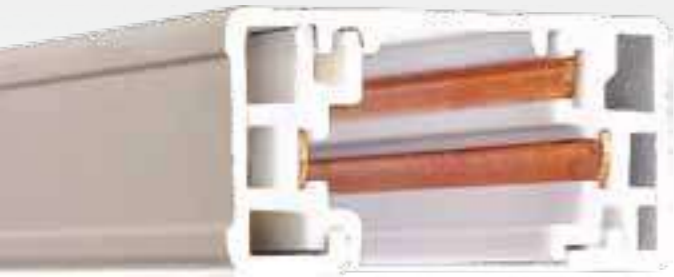

# Single Circuit Track System 3 Wires

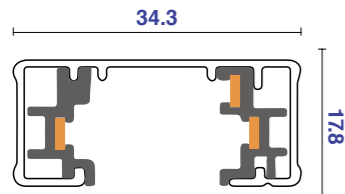

Model No.	Track length	Shell Material	Colour	Package
JPro-0310A	1M track with double end cap.(100cm)	Aluminum Extrusion	White <input type="checkbox"/> Silver <input type="checkbox"/> Black <input checked="" type="checkbox"/>	1 / 12
JPro-0320A	2M track with double end cap.(200cm)	Aluminum Extrusion	White <input type="checkbox"/> Silver <input type="checkbox"/> Black <input checked="" type="checkbox"/>	1 / 12
JPro-0330A	3M track with double end cap.(300cm)	Aluminum Extrusion	White <input type="checkbox"/> Silver <input type="checkbox"/> Black <input checked="" type="checkbox"/>	1 / 9
JPro-03400A	4M track with double end cap.(400cm)	Aluminum Extrusion	White <input type="checkbox"/> Silver <input type="checkbox"/> Black <input checked="" type="checkbox"/>	1 / 9
JPro-0302A	2'track with double end cap actual length24"	Aluminum Extrusion	White <input type="checkbox"/> Silver <input type="checkbox"/> Black <input checked="" type="checkbox"/>	1 / 12
JPro-0304A	4'track with double end cap actual length48"	Aluminum Extrusion	White <input type="checkbox"/> Silver <input type="checkbox"/> Black <input checked="" type="checkbox"/>	1 / 12
JPro-0306A	6'track with double end cap actual length72"	Aluminum Extrusion	White <input type="checkbox"/> Silver <input type="checkbox"/> Black <input checked="" type="checkbox"/>	1 / 12
JPro-0308A	8'track with double end cap actual length96"	Aluminum Extrusion	White <input type="checkbox"/> Silver <input type="checkbox"/> Black <input checked="" type="checkbox"/>	1 / 12
JPro-0310B	1M track with live end & end cap.(100cm)	Aluminum Extrusion	White <input type="checkbox"/> Silver <input type="checkbox"/> Black <input checked="" type="checkbox"/>	1 / 12
JPro-0320B	2M track with live end & end cap.(200cm)	Aluminum Extrusion	White <input type="checkbox"/> Silver <input type="checkbox"/> Black <input checked="" type="checkbox"/>	1 / 12
JPro-0330B	3M track with live end & end cap.(300cm)	Aluminum Extrusion	White <input type="checkbox"/> Silver <input type="checkbox"/> Black <input checked="" type="checkbox"/>	1 / 9
JPro-03400B	4M track with live end & end cap.(400cm)	Aluminum Extrusion	White <input type="checkbox"/> Silver <input type="checkbox"/> Black <input checked="" type="checkbox"/>	1 / 9
JPro-0302B	2'track with live end and end cap actual length24"	Aluminum Extrusion	White <input type="checkbox"/> Silver <input type="checkbox"/> Black <input checked="" type="checkbox"/>	1 / 12
JPro-0304B	4'track with live end and end cap actual length48"	Aluminum Extrusion	White <input type="checkbox"/> Silver <input type="checkbox"/> Black <input checked="" type="checkbox"/>	1 / 12
JPro-0306B	6'track with live end and end cap actual length72"	Aluminum Extrusion	White <input type="checkbox"/> Silver <input type="checkbox"/> Black <input checked="" type="checkbox"/>	1 / 12
JPro-0308B	8'track with live end and end cap actual length96"	Aluminum Extrusion	White <input type="checkbox"/> Silver <input type="checkbox"/> Black <input checked="" type="checkbox"/>	1 / 12
JPro-0310C	1M track with live end & end cap.(100cm)	Aluminum Extrusion	White <input type="checkbox"/> Silver <input type="checkbox"/> Black <input checked="" type="checkbox"/>	1 / 12
JPro-0320C	2M track with live end & end cap.(200cm)	Aluminum Extrusion	White <input type="checkbox"/> Silver <input type="checkbox"/> Black <input checked="" type="checkbox"/>	1 / 12
JPro-0330C	3M track with live end & end cap.(300cm)	Aluminum Extrusion	White <input type="checkbox"/> Silver <input type="checkbox"/> Black <input checked="" type="checkbox"/>	1 / 9
JPro-03400C	4M track with live end & end cap.(400cm)	Aluminum Extrusion	White <input type="checkbox"/> Silver <input type="checkbox"/> Black <input checked="" type="checkbox"/>	1 / 9
JPro-0302C	2'track with live end and end cap actual length24"	Aluminum Extrusion	White <input type="checkbox"/> Silver <input type="checkbox"/> Black <input checked="" type="checkbox"/>	1 / 12
JPro-0304C	4'track with live end and end cap actual length48"	Aluminum Extrusion	White <input type="checkbox"/> Silver <input type="checkbox"/> Black <input checked="" type="checkbox"/>	1 / 12
JPro-0306C	6'track with live end and end cap actual length72"	Aluminum Extrusion	White <input type="checkbox"/> Silver <input type="checkbox"/> Black <input checked="" type="checkbox"/>	1 / 12
JPro-0308C	8'track with live end and end cap actual length96"	Aluminum Extrusion	White <input type="checkbox"/> Silver <input type="checkbox"/> Black <input checked="" type="checkbox"/>	1 / 12

# Single Circuit Recessed 3 Wires

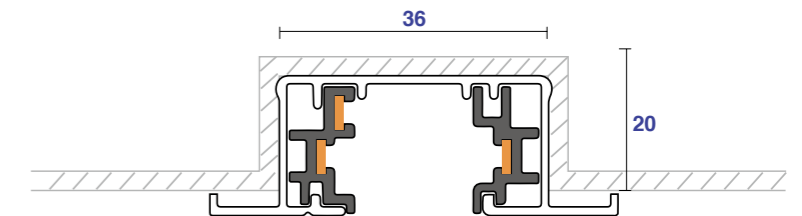
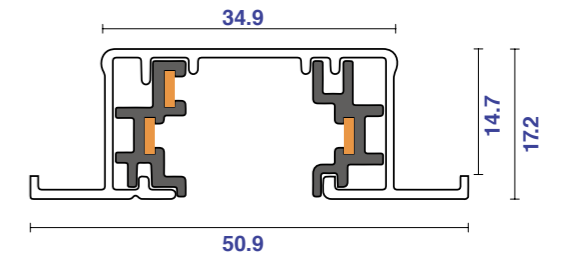

Model No.	Track length	Shell Material	Colour	Package
JPro-R310A	1M track with double end cap.(100cm)	Aluminum Extrusion	White <input type="checkbox"/> Silver <input type="checkbox"/> Black <input checked="" type="checkbox"/>	1 / 12
JPro-R320A	2M track with double end cap.(200cm)	Aluminum Extrusion	White <input type="checkbox"/> Silver <input type="checkbox"/> Black <input checked="" type="checkbox"/>	1 / 12
JPro-R330A	3M track with double end cap.(300cm)	Aluminum Extrusion	White <input type="checkbox"/> Silver <input type="checkbox"/> Black <input checked="" type="checkbox"/>	1 / 12
JPro-R3400A	4M track with double end cap.(400cm)	Aluminum Extrusion	White <input type="checkbox"/> Silver <input type="checkbox"/> Black <input checked="" type="checkbox"/>	1 / 9
JPro-R302A	2'track with double end cap actual length24"	Aluminum Extrusion	White <input type="checkbox"/> Silver <input type="checkbox"/> Black <input checked="" type="checkbox"/>	1 / 12
JPro-R304A	4'track with double end cap actual length48"	Aluminum Extrusion	White <input type="checkbox"/> Silver <input type="checkbox"/> Black <input checked="" type="checkbox"/>	1 / 12
JPro-R306A	6'track with double end cap actual length72"	Aluminum Extrusion	White <input type="checkbox"/> Silver <input type="checkbox"/> Black <input checked="" type="checkbox"/>	1 / 12
JPro-R308A	8'track with double end cap actual length96"	Aluminum Extrusion	White <input type="checkbox"/> Silver <input type="checkbox"/> Black <input checked="" type="checkbox"/>	1 / 12
JPro-R310B	1M track with live end & end cap.(100cm)	Aluminum Extrusion	White <input type="checkbox"/> Silver <input type="checkbox"/> Black <input checked="" type="checkbox"/>	1 / 12
JPro-R320B	2M track with live end & end cap.(200cm)	Aluminum Extrusion	White <input type="checkbox"/> Silver <input type="checkbox"/> Black <input checked="" type="checkbox"/>	1 / 12
JPro-R330B	3M track with live end & end cap.(300cm)	Aluminum Extrusion	White <input type="checkbox"/> Silver <input type="checkbox"/> Black <input checked="" type="checkbox"/>	1 / 12
JPro-R3400B	4M track with live end & end cap.(400cm)	Aluminum Extrusion	White <input type="checkbox"/> Silver <input type="checkbox"/> Black <input checked="" type="checkbox"/>	1 / 9
JPro-R302B	2'track with live end and end cap actual length24"	Aluminum Extrusion	White <input type="checkbox"/> Silver <input type="checkbox"/> Black <input checked="" type="checkbox"/>	1 / 12
JPro-R304B	4'track with live end and end cap actual length48"	Aluminum Extrusion	White <input type="checkbox"/> Silver <input type="checkbox"/> Black <input checked="" type="checkbox"/>	1 / 12
JPro-R306B	6'track with live end and end cap actual length72"	Aluminum Extrusion	White <input type="checkbox"/> Silver <input type="checkbox"/> Black <input checked="" type="checkbox"/>	1 / 12
JPro-R308B	8'track with live end and end cap actual length96"	Aluminum Extrusion	White <input type="checkbox"/> Silver <input type="checkbox"/> Black <input checked="" type="checkbox"/>	1 / 12



# Single Circuit Track System 2 Wires

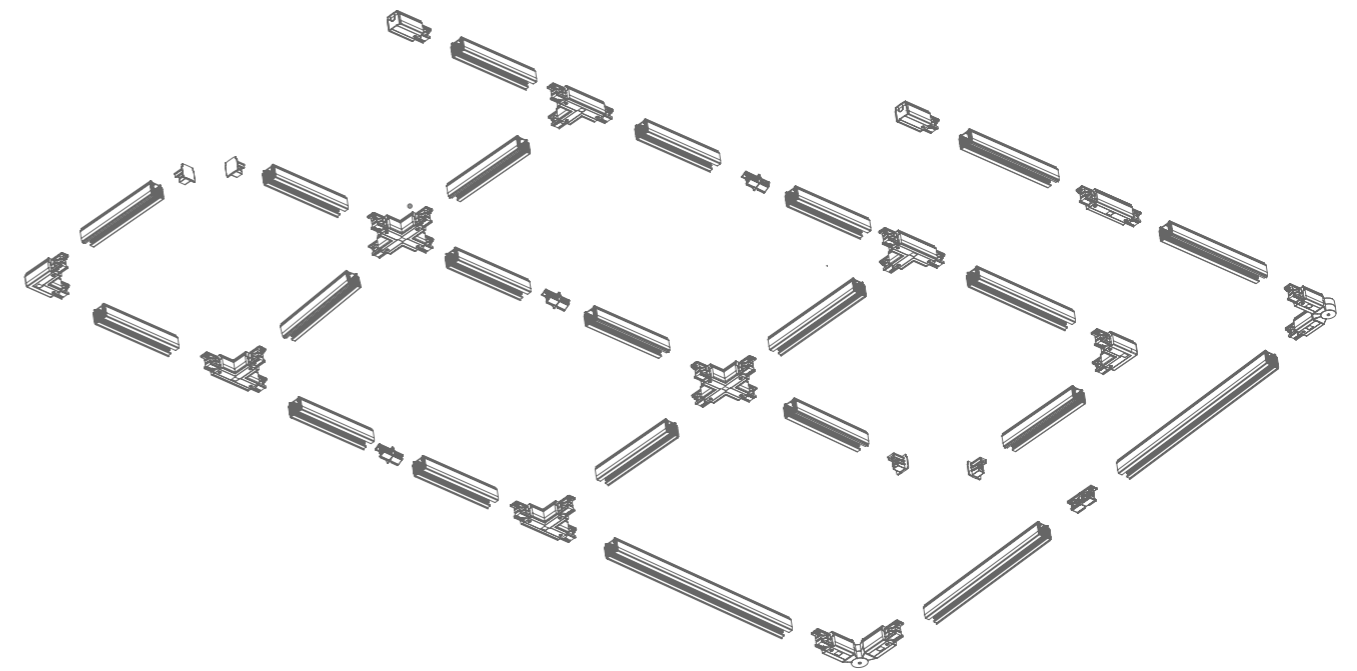
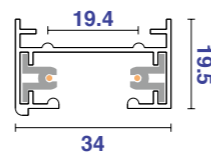

Model No.	Track length	Shell Material	Colour
JPro-L210-W	1M / 1.5M / 2M / 3M track actual one meter.(100cm / 150cm / 200cm / 300cm)	Aluminum Extrusion	White <input type="checkbox"/> Silver <input type="checkbox"/> Black <input type="checkbox"/> <input checked="" type="checkbox"/>



Model No.	Track length	Shell Material	Colour
JPro-RL210-W	1M / 1.5M / 2M / 3M track actual one meter.(100cm / 150cm / 200cm / 300cm)	Aluminum Extrusion	White <input type="checkbox"/> Silver <input type="checkbox"/> Black <input type="checkbox"/> <input checked="" type="checkbox"/>

LED Track light



# LED Panel Light

## /Series/

LED panel light is one of the most popular luminaire for commercial lighting, with continuous modification of its design, light efficiency, CRI, UGR and smart function, Jibe Lighting is always capable of providing customers with helpful solution and best price, that's the main reason Jibe Lighting is preferred supplier of LED panel lamp in the market. Jibe Lighting panel family supplies different solution for project and distribution, such us regular LED panel with high Lumen and low UGR, CCT changing LED panel, waterproof led panel, frameless led panel, Up/down emitting led panel, big size round led panel with recessed / surface mounted / pendant installation, TUV-CE approved Jibe lighting driver and Lifud, Tridonic, Philips driver ensure our reputation of quality always.

# JGL-P Panel light

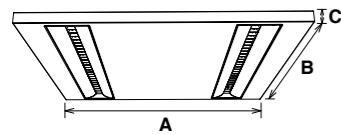

JGL-P panel light is direct lighting with louver anti-glare design with external driver, adopting high lumen SMD led and special lens which provide high light efficiency and uniform light output, SPCC housing plus PC + ABS module form ideal combination of stylish design, it is a perfect replacement for traditional grill lamp.

- ▶
- ▶
- ▶
- ▶

Code	Watt	Size(AxBxCmm)	Cut-out(±5mm)	Lumen(±5%)	N.W/pc(kgs)	Q'ty/CTN
JGL6060-35W-P	35W	595x595x23.5	580x580	4085lm	3.50	4PCS
JGL6262-35W-P	35W	620x620x23.5	605x605	4090lm	3.65	4PCS
JGL30120-35W-P	35W	1195x295x23.5	1180x280	3995lm	3.55	4PCS

CCT — 3000K 4000K 5000K 5700K

Finish — White

# JPL-AZ Panel light

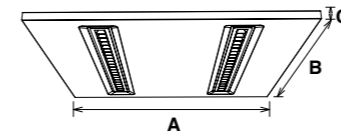

JPL-AZ panel light is direct lighting with louver anti-glare design with external driver, adopting high lumen SMD led and special lens which provide high light efficiency and uniform light output, SPCC housing plus PC module form ideal combination of stylish design, the luminous module can be replaced, which ensure the easy maintenance.it is a ideal replacement for traditional 3\*24W HO T5 and 3\*18W T8 fluorescent louver luminaries and side lit LED panel light.

- ▶
- ▶
- ▶
- ▶

Code	Watt	Size(AxBxCmm)	Cut-out(±5mm)	Lumen(±5%)	N.W/pc(kgs)	Q'ty/CTN
JPL6060-30W-AZ	30W	595x595x15	580x580	3450lm	3.20	4PCS
JPL6060-35W-AZ	35W	595x595x15	580x580	3950lm	3.20	4PCS
JPL6262-30W-AZ	30W	620x620x15	605x605	3450lm	3.50	4PCS
JPL6262-35W-AZ	35W	620x620x15	605x605	3950lm	3.50	4PCS
JPL30120-30W-AZ	30W	1195x295x17.5	1180x280	3450lm	3.60	4PCS
JPL30120-35W-AZ	35W	1195x295x17.5	1180x280	3950lm	3.60	4PCS

CCT — 3000K 4000K 5000K 5700K

Finish — White

# JPL-AK Panel light

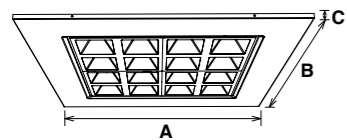

JPL-AK panel light is a module design with external driver, featuring PC louver reflectors to help reduce UGR, offers the ideal combination of stylish design and optimum performance for both task and general lighting; Module replaceable, easy to install and maintain. Available in various installation ways: recessed, suspended and surface mounted, and can replace the traditional panel light.

- ▶ 100°
- ▶ IP40
- ▶ UGR<16
- ▶ DIM
- ▶ DALI
- ▶ 0-10V
- ▶ TUNABLE WHITE
- ▶ SLIDE SWITCH 3 in 1
- ▶ AC 220-240V
- ▶ PF≥0.9
- ▶ CRI≥80
- ▶ RoHS
- ▶ CE

Code	Watt	Size(AxBxCmm)	Cut-out(±5mm)	Lumen(±5%)	N.W/pc(kgs)	Q'ty/CTN
JPL3060-18W-AK	18W	595x295x36	580x280	2010lm	1.55	4PCS
JPL6060-25W-AK	25W	595x595x36	580x580	3552lm	2.90	4PCS
JPL6060-30W-AK	30W	595x595x36	580x580	3660lm	2.90	4PCS
JPL6060-36W-AK	36W	595x595x36	580x580	3900lm	2.90	4PCS
JPL6262-36W-AK	36W	620x620x36	605x605	3900lm	3.30	4PCS
JPL30120-36W-AK	36W	1195x295x36	1180x280	3920lm	2.95	4PCS

CCT — 3000K 4000K 5000K 5700K

Finish — White

# JPL-CB Panel light

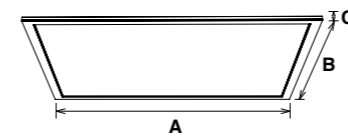

JPL-CB panel light is a 9mm thickness panel with external driver; PMMA LGP produce uniform light and high lumen output; Adopts high lumen SMD with CRI>80, 100lm/W, 130lm/W, SDCM<3 solution can be provided, Triac dim, 0-10V dimmable, DALI dimmable, Emergency all available. It can fit seamlessly into any work place, available in various installation ways: recessed, suspended and surface mounted.

- ▶ 120°
- ▶ IP40
- ▶ UGR<19
- ▶ DIM
- ▶ DALI
- ▶ 0-10V
- ▶ SLIDE SWITCH 3 in 1
- ▶ Smart Lighting
- ▶ AC 220-240V
- ▶ PF≥0.9
- ▶ CRI≥80
- ▶ SDCM <3
- ▶ TP(a)
- ▶ TP(b)
- ▶ RoHS
- ▶ CE
- ▶ CB

Code	Watt	Size(AxBxCmm)	Cut-out(±5mm)	Lumen(±5%)	N.W/pc(kgs)	Q'ty/CTN
JPL3030-18W-CB	18W	295x295x9	280x280	100LM/W	0.85	5PCS
JPL3060-20W-CB	20W	595x295x9	580x280	100LM/W	1.35	5PCS
JPL30120-33W-CB	33W	1195x295x9	1180x280	100LM/W	2.40	5PCS
JPL30120-42W-CB	42W	1195x295x9	1180x280	100LM/W	2.40	5PCS
JPL6060-33W-CB	33W	595x595x9	580x580	100LM/W	2.35	5PCS
JPL6060-42W-CB	42W	595x595x9	580x580	100LM/W	2.35	5PCS
JPL60120-60W-CB	60W	1195x595x9	1180x580	100LM/W	5.30	2PCS
JPL6262-33W-CB	33W	620x620x9	605x605	100LM/W	2.55	5PCS
JPL6262-42W-CB	42W	620x620x9	605x605	100LM/W	2.55	5PCS
JPL6060-25W-CB	25W	595x595x9	580x580	130LM/W	2.35	5PCS
JPL6262-25W-CB	25W	620x620x9	605x605	130LM/W	2.55	5PCS
JPL30120-25W-CB	25W	1195x295x9	1180x280	130LM/W	2.40	5PCS
JPL60120-45W-CB	45W	1195x595x9	1180x580	130LM/W	5.30	2PCS

CCT — 3000K 4000K 5000K 5700K

Finish — White



# JPL-CK Backlit panel light

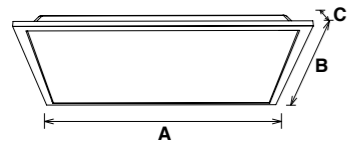

JPL-CK LED panel is a direct lighting with external driver, adopts SMD led with optical lens to provide a uniform light effect, no LGP design makes this panel more cost effective compared with normal edge-lit panel light, UGR<19 available, high efficiency available with 100lm/W, 120lm/W and 140lm/W. Recessed, suspended and surface mounted installation ways for choice.

- ▶
- ▶
- ▶
- ▶
- ▶
- ▶



# JPL-CK Backlit panel light

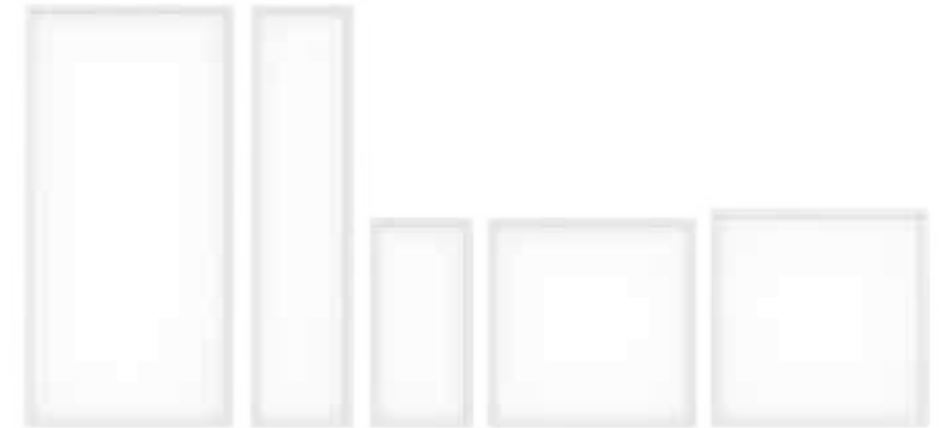

Code	Watt	Size(AxBxCmm)	Cut-out(±5mm)	Lumen(±5%)	N.W/pc(kgs)	Q'ty/CTN
JPL3060-16W-CK	16W	595x295x32	580x280	100LM/W	1.01	5PCS/6PCS
JPL6060-36W-CK	36W	595x595x32	580x580	100LM/W	1.56	5PCS/6PCS
JPL6262-36W-CK	36W	620x620x32	605x605	100LM/W	1.98	5PCS/6PCS
JPL30120-36W-CK	36W	1195x295x32	1180x280	100LM/W	1.72	5PCS/6PCS
JPL60120-60W-CK	60W	1195x595x32	1180x580	100LM/W	3.20	4PCS/4PCS
JPL3060-16W-CK	16W	595x295x32	580x280	120LM/W	1.01	5PCS/6PCS
JPL6060-30W-CK	30W	595x595x32	580x580	120LM/W	1.56	5PCS/6PCS
JPL6262-30W-CK	30W	620x620x32	605x605	120LM/W	1.98	5PCS/6PCS
JPL30120-30W-CK	30W	1195x295x32	1180x280	120LM/W	1.72	5PCS/6PCS
JPL60120-50W-CK	50W	1195x595x32	1180x580	120LM/W	3.20	4PCS
JPL60120-60W-CK	60W	1195x595x32	1180x580	120LM/W	3.20	4PCS
JPL6060-30W-CK	30W	595x595x32	580x580	140LM/W	1.56	5PCS/6PCS
JPL6262-30W-CK	30W	620x620x32	605x605	140LM/W	1.98	5PCS/6PCS
JPL30120-30W-CK	30W	1195x295x32	1180x280	140LM/W	1.72	5PCS/6PCS
JPL60120-50W-CK	50W	1195x595x32	1180x580	140LM/W	3.20	4PCS

CCT — 3000K — 4000K — 5000K — 5700K

Finish — White

## JPL-CK2 Backlit panel light

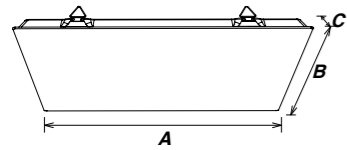

JPL-CK2 is a backlit trimless design. Adopt high lumen SMD light source and could be interchangeable CCT (3000K+4000K +5700K) with slide switch.

- ▶ 120° IP40
- ▶ DIM DALI 0-10V SLIDE SWITCH
- ▶ AC 200-240V PF ≥ 0.85 CRI ≥ 80 TP(a) TP(b)
- ▶ SAA CE CB

Code	Watt	Size(AxBxCmm)	Cut-out(±5mm)	Lumen(±5%)	N.W/pc(kgs)	Q'ty/CTN
JPL6060-36W-CK2	36W	595x595x32	580x580	100LM/W	1.80	5PCS

CCT — 3000K — 4000K — 5700K

Finish — White

## JPL-CK3 Backlit panel light

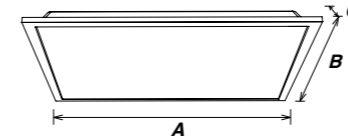

JPL-CK3 is an economic backlit type with plastic frame. Adopt high lumen SMD light source and could be interchangeable CCT (3000K+4000K +5700K) with slide switch.

- ▶ 120° IP40
- ▶ DIM DALI 0-10V SLIDE SWITCH
- ▶ AC 200-240V PF ≥ 0.85 CRI ≥ 80 TP(a) TP(b)
- ▶ SAA CE CB

Code	Watt	Size(AxBxCmm)	Cut-out(±5mm)	Lumen(±5%)	N.W/pc(kgs)	Q'ty/CTN
JPL3030-10W-CK3	10W	295x295x32	280x280	1000lm	1.00	10PCS
JPL3060-18W-CK3	18W	595x295x32	580x280	1800lm	1.85	5PCS
JPL6060-36W-CK3	36W	595x595x32	580x580	3600lm	2.25	5PCS
JPL6262-36W-CK3	36W	620x620x32	605x605	3600lm	2.60	5PCS
JPL30120-36W-CK3	36W	1195x295x32	1180x280	3600lm	2.30	5PCS

CCT — 3000K — 4000K — 5700K

Finish — White



# JPL-AM1 Panel light

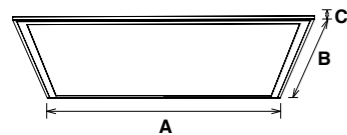

JPL-AM1 panel is 8mm thickness panel, adopts high lumen SMD LED with CRI >80. Top branded external driver comes with triac dim, 0-10V dim and DALI dim, it has perfect dimming range and shares great compatibility with worldwide famous brand dimmers. The ultra slim profile fits seamlessly into any work place. It is available in various installation ways: embedded into ceiling, suspended with hanging wires, surface mounted in a concrete ceiling by using surface mounting frame.

- ▶ 120°
- ▶ IP40
- ▶ UGR<19
- ▶ DIM
- ▶ DALI
- ▶ 0-10V
- ▶ TUNABLE WHITE
- ▶ SLIDE SWITCH 3 in 1
- ▶ AC 200-240V
- ▶ PF≥0.9
- ▶ CRI≥80
- ▶ TP(a)
- ▶ TP(b)
- ▶ SAA
- ▶ RoHS
- ▶ CE
- ▶ CB

Code	Watt	Size(AxBxCmm)	Cut-out(±5mm)	Lumen(±5%)	N.W/pc(kgs)	Q'ty/CTN
JPL3030-18W-AM1	18W	295x295x8	280x280	1355lm	1.20	5PCS
JPL6060-36W-AM1	36W	595x595x8	580x580	3200lm	2.28	5PCS
JPL6262-36W-AM1	36W	620x620x8	605x605	3105lm	3.10	5PCS
JPL30120-36W-AM1	36W	1195x295x8	1180x280	3190lm	2.30	5PCS
JPL60120-60W-AM1	60W	1195x595x8	1180x580	5760lm	5.00	2PCS

CCT 3000K 4000K 5000K 5700K

Finish White

# JPL-AF1 Panel light

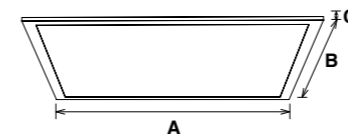

JPL-AF1 panel is 8mm thickness panel, adopts high lumen SMD LED with CRI >80. Top branded external driver comes with triac dim, 0-10V dim and DALI dim, it has perfect dimming range and shares great compatibility with worldwide famous brand dimmers. The ultra slim profile fits seamlessly into any work place. It is available in various installation ways: embedded into ceiling, suspended with hanging wires, surface mounted in a concrete ceiling by using surface mounting frame.

- ▶ 120°
- ▶ IP40
- ▶ UGR<19
- ▶ DIM
- ▶ DALI
- ▶ 0-10V
- ▶ TUNABLE WHITE
- ▶ SLIDE SWITCH 3 in 1
- ▶ AC 200-240V
- ▶ PF≥0.9
- ▶ CRI≥80
- ▶ TP(a)
- ▶ TP(b)
- ▶ SAA
- ▶ RoHS
- ▶ CE
- ▶ CB

Code	Watt	Size(AxBxCmm)	Cut-out(±5mm)	Lumen(±5%)	N.W/pc(kgs)	Q'ty/CTN
JPL3030-18W-AF1	18W	295x295x8	280x280	1355lm	1.20	5PCS
JPL6060-36W-AF1	36W	595x595x8	580x580	3200lm	2.28	5PCS
JPL6262-36W-AF1	36W	620x620x8	605x605	3105lm	3.10	5PCS
JPL30120-36W-AF1	36W	1195x295x8	1180x280	3190lm	2.30	5PCS
JPL60120-60W-AF1	60W	1195x595x8	1180x580	5760lm	5.00	2PCS

CCT 3000K 4000K 5000K 5700K

Finish White

# JPL-G5A Panel light

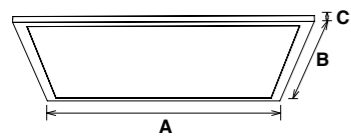

JPL-G5A panel is 10mm thickness panel, which adopts high lumen SMD LED with CRI >80, 100lm/W and 120lm/W optional. Top branded external driver comes with triac dim, 0-10V dim and DALI dim, it has perfect dimming range and shares great compatibility with worldwide famous brand dimmers. It is available in various installation ways: embedded into ceiling, suspended with hanging wires, surface mounted in a concrete ceiling by using surface mounting frame.

- ▶ 120° IP40
- ▶ DIM DALI 0-10V TUNABLE WHITE SLIDE SWITCH 3 in 1
- ▶ AC 200-240V PF≥0.9 CRI≥80 TP(a) TP(b)
- ▶ SAA RoHS CE

Code	Watt	Size(AxBxCmm)	Cut-out(±5mm)	Lumen(±5%)	N.W/pc(kgs)	Q'ty/CTN
JPL3030-18W-G5A	18W	295x295x10	280x280	1685lm	1.35	5PCS
JPL3060-20W-G5A	20W	595x295x10	580x280	1920lm	2.50	5PCS
JPL30120-26W-G5A	26W	1195x295x10	1180x280	3210lm	3.80	5PCS
JPL30120-42W-G5A	42W	1195x295x10	1180x280	4200lm	3.80	5PCS
JPL6060-26W-G5A	26W	595x595x10	580x580	3265lm	3.70	5PCS
JPL6060-42W-G5A	42W	595x595x10	580x580	4250lm	3.70	5PCS
JPL60120-60W-G5A	60W	1195x595x10	1180x580	6240lm	7.50	2PCS
JPL6262-26W-G5A	26W	620x620x10	605x605	3290lm	4.20	5PCS
JPL6262-42W-G5A	42W	620x620x10	605x605	4250lm	4.20	5PCS

CCT 3000K 4000K 5000K 5700K

Finish White

# JPL-G6A Panel light

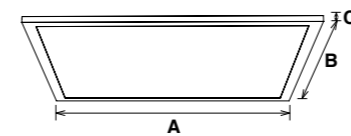

JPL-G6A is UGR<19 LED panel with 10mm thickness, which adopts high lumen SMD LED with CRI >80, 100lm/W and 120lm/W optional. It also can meet the medical light source COI <3.3. Top branded external driver comes with triac dim, 0-10V dim and DALI dim, it has perfect dimming range and shares great compatibility with worldwide famous brand dimmers. The ultra slim profile fits seamlessly into any work place. It is available in various installation ways: embedded into ceiling, suspended with hanging wires, surface mounted in a concrete ceiling by using surface mounting frame.

- ▶ 80° IP40 UGR<19
- ▶ DIM DALI 0-10V TUNABLE WHITE SLIDE SWITCH 3 in 1
- ▶ AC 200-240V PF≥0.9 CRI≥80 TP(a) TP(b)
- ▶ SAA RoHS CE

Code	Watt	Size(AxBxCmm)	Cut-out(±5mm)	Lumen(±5%)	N.W/pc(kgs)	Q'ty/CTN
JPL3030-18W-G6A	18W	295x295x10	280x280	1665lm	1.35	5PCS
JPL3060-20W-G6A	20W	595x295x10	580x280	1900lm	2.50	5PCS
JPL30120-26W-G6A	26W	1195x295x10	1180x280	3175lm	3.80	5PCS
JPL30120-42W-G6A	42W	1195x295x10	1180x280	4200lm	3.80	5PCS
JPL6060-26W-G6A	26W	595x595x10	580x580	3190lm	3.70	5PCS
JPL6060-42W-G6A	42W	595x595x10	580x580	4250lm	3.70	5PCS
JPL60120-60W-G6A	60W	1195x595x10	1180x580	6060lm	7.50	2PCS
JPL6262-26W-G6A	26W	620x620x10	605x605	3230lm	4.20	5PCS
JPL6262-42W-G6A	42W	620x620x10	605x605	4250lm	4.20	5PCS

CCT 3000K 4000K 5000K 5700K

Finish White



## JPL-CC Panel light

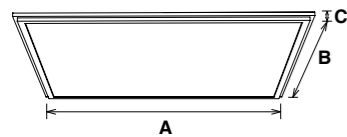

JPL-CC panel is 14.3mm thickness panel with external driver, adopts high lumen LED chips with CRI>80, PMMA LGP produces uniform and comfortable light. Stronger frame makes better heat dissipation than common panels. The lighting area fits seamlessly with the ceiling. Recessed installation with clips make it suitable for more kinds of ceiling perfectly.

- ▶ 120° IP40 UGR<19
- ▶ DIM DALI 0-10V
- ▶ AC 220-240V PF≥0.9 CRI≥80 TP(a) TP(b)
- ▶

Code	Watt	Size(AxBxCmm)	Cut-out(±5mm)	Lumen(±5%)	N.W/pc(kgs)	Q'ty/CTN
JPL6060-33W-CC	33W	595x595x14.3	580x580	3530lm	2.50	5PCS
JPL6060-42W-CC	42W	595x595x14.3	580x580	4370lm	2.50	5PCS
JPL30120-33W-CC	33W	1195x295x14.3	1180x280	3400lm	2.65	5PCS
JPL30120-42W-CC	42W	1195x295x14.3	1180x280	4210lm	2.65	5PCS

CCT 3000K 4000K 5000K 5700K

Finish White

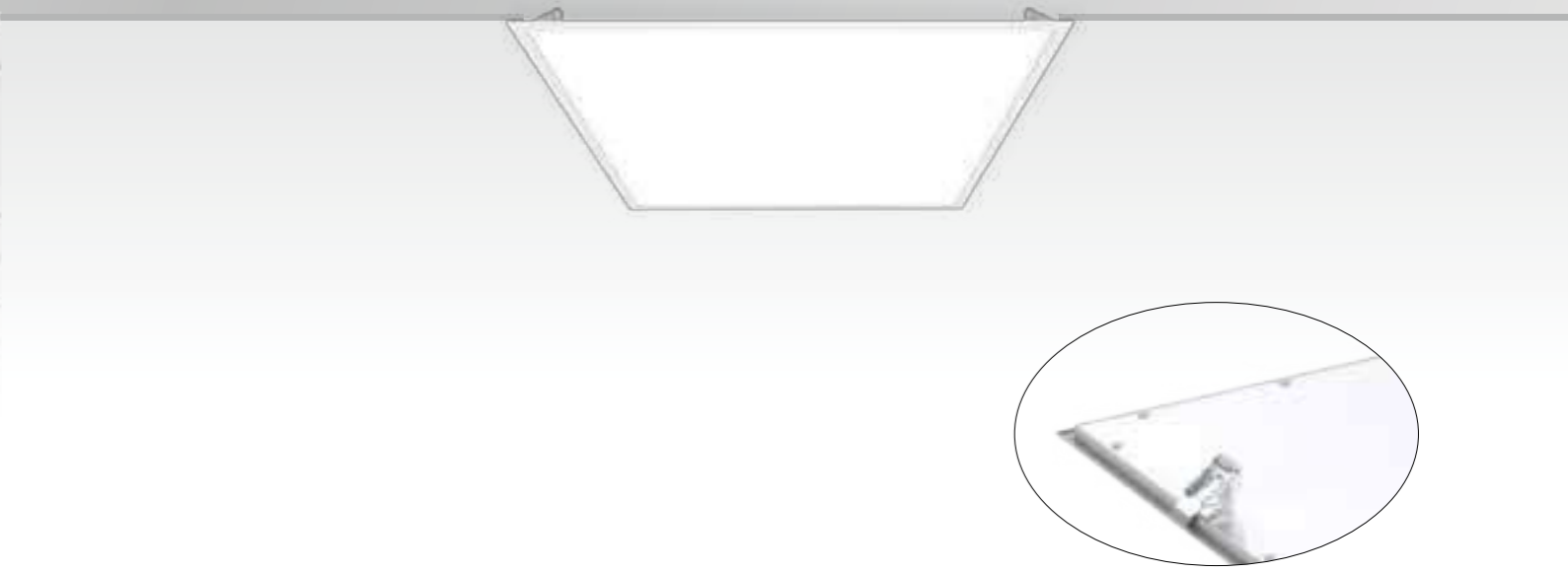

## JPL-CD Panel light



JPL-CD panel light is 8.5mm thickness frame with fixed spring design panel light with external driver, adopts high lumen LED chips with CRI>80, special frame design provides excellent thermal management. Recessed installation with clips makes it suitable for more kinds of ceiling.

- ▶ 120° IP40 UGR<19
- ▶ DIM DALI 0-10V
- ▶ AC 220-240V PF≥0.9 CRI≥80 TP(a) TP(b)
- ▶

Code	Watt	Size(AxBxCxDmm)	Cut-out(±5mm)	Lumen(±5%)	N.W/pc(kgs)	Q'ty/CTN
JPL6060-33W-CD	33W	595x595x35.5	580x580	3460lm	2.35	5PCS
JPL30120-33W-CD	33W	1195x295x35.5	1180x280	3400lm	2.40	5PCS

CCT 3000K 4000K 5000K 5700K

Finish White

# JPL-BC Panel light

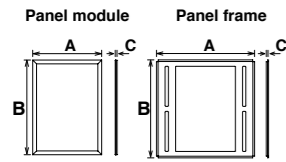

JPL-BC panel light consist of metal frame and LED panel with external driver, LED panel adopts prismatic diffuser (low glare UGR<19) which produce uniform light and high lumen output; The metal frame with air slot design to allow the air to circulate; Separated panel module ensures the easy installation and maintenance, it is a ideal replacement for traditional T8 fluorescent louver luminaires and side lit LED panel light.

- ▶
- ▶
- ▶
- ▶

Code	Watt	Size(AxBxCmm)	Cut-out(±5mm)	Lumen(±5%)	N.W/pc(kgs)	Q'ty/CTN
JPL6060-40W-BC	40W	595x595x11	580x580	4165lm	/	/
Panel Module	/	570x415x8	/	/	1.85	5PCS
Panel Frame	/	595x595x11	/	/	1.40	5PCS

CCT — 3000K 4000K 5000K 5700K

Finish — White

# JPL-CQ Panel light



JPL-CQ panel light is IP65 waterproof design with external driver. Adopt high lumen efficiency SMD LED with even light output. Aluminum frame provides excellent thermal management. Multiple installation way: recessed, suspended and surface mounted.

- ▶
- ▶
- ▶
- ▶

Code	Watt	Size(AxBxCmm)	Cut-out(±5mm)	Lumen(±5%)	N.W/pc(kgs)	Q'ty/CTN
JPL3030-18W-CQ	18W	295x295x8	280x280	1890lm	1.03	10PCS
JPL3060-20W-CQ	20W	595x295x8	580x280	2100lm	1.67	5PCS
JPL6060-36W-CQ	36W	595x595x8	580x580	3780lm	2.85	4PCS
JPL6262-36W-CQ	36W	620x620x8	605x605	3780lm	3.04	4PCS
JPL30120-36W-CQ	36W	1195x295x8	1180x280	3780lm	2.89	4PCS

CCT — 3000K 4000K 5000K 5700K

Finish — White

# JPL-CL Panel light



JPL-CL LED panel light is a screwless design with flat frame and no back plate, adopting PMMA LGP which produces uniform light and high lumen output, good quality SMD with 110lm/W. Triac dim, 0-10V dimmable, DALI dimmable and 3 CCT interchangeable are available. It can fit seamlessly into any work place, available in various installation ways: recessed, suspended and surface mounted.

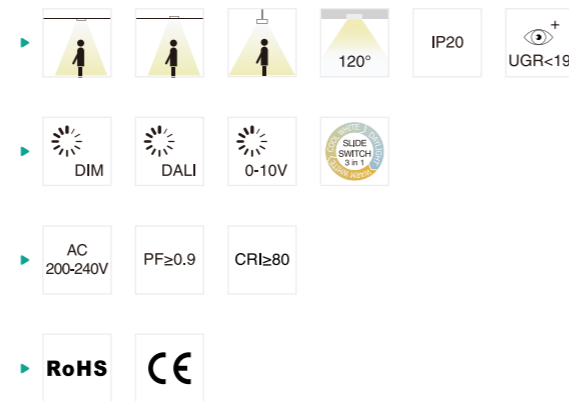

Code	Watt	Size(AxBxCmm)	Cut-out(±5mm)	Lumen(±5%)	N.W/pc(kgs)	Q'ty/CTN
JPL3030-18W-CL	18W	295x295x9	280x280	1850lm	0.56	10PCS
JPL3060-20W-CL	20W	295x595x9	280x280	2100lm	0.95	5PCS
JPL6060-30W-CL	30W	595x595x9	580x580	3650lm	1.60	5PCS
JPL6262-30W-CL	30W	620x620x9	605x605	3650lm	1.75	5PCS
JPL30120-30W-CL	30W	1195x295x9	1180x280	3600lm	1.70	5PCS
JPL6060-36W-CL	36W	595x595x9	580x580	4000lm	1.60	5PCS
JPL6262-36W-CL	36W	620x620x9	605x605	4000lm	1.75	5PCS
JPL30120-36W-CL	36W	1195x295x9	1180x280	3900lm	1.70	5PCS

CCT — 3000K 4000K 5000K 5700K

Finish — White

# JPL-DE Panel light

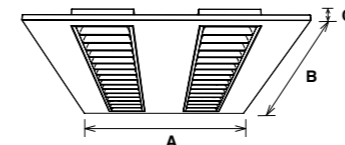

JPL-DE is a new grill design with UGR<19. COI (Cyanosis Observation Index) compliant. Air slot available.

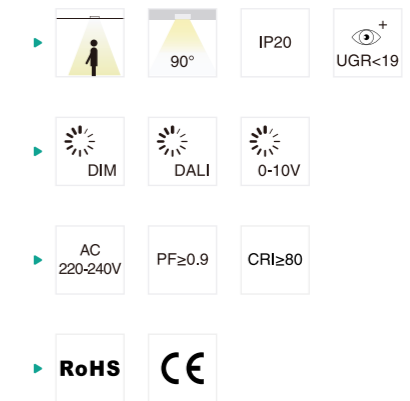

Code	Watt	Size(AxBxCmm)	Cut-out(±5mm)	Lumen(±5%)	N.W/pc(kgs)	Q'ty/CTN
JPL3060-DE	13W	292x592x48	/	1365lm	2.60	4PCS
JPL3012-DE	28W	1192x292x48	/	2940lm	2.99	4PCS
JPL4012-DE	28W	1192x392x48	/	2940lm	2.73	2PCS
JPL6060-DE	28W	592x592x48	/	2940lm	5.41	4PCS
JPL3015-DE	40W	1492x292x48	/	4200lm	3.73	4PCS

CCT — 3000K 4000K 5000K 5700K

Finish — White

# JGL-AA Panel light

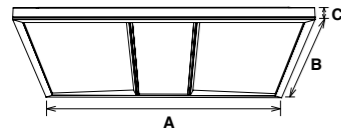

JGL-AA backlit troffer is new anti-glare design, the compact and seamless splicing make it a great looking. It adopts anti-glare prism plate to reach UGR<19, could be interchangeable CCT (3000K+4000K +5700K) with slide switch.

- ▶ 90°
- ▶
- ▶
- ▶

Code	Watt	Size(AxBxCmm)	Cut-out(±5mm)	Lumen(±5%)	N.W/pc(kgs)	Q'ty/CTN
JGL6060-36W-AA	36W	595x595x49	580x580	3960lm	2.60	5PCS
JGL30120-36W-AA	36W	1195x295x49	1180x280	3960lm	2.99	5PCS
JGL6262-36W-AA	36W	620x620x49	605x605	3960lm	2.73	5PCS
JGL60120-60W-AA	60W	1195x595x49	1180x580	6500lm	5.41	2PCS

CCT — 3000K 4000K 5000K 5700K

Finish — White

# JGL-N Troffer light

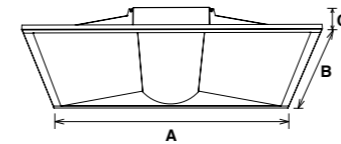

JGL-N is troffer light with external driver, adopts secondary optical designed and special treatment diffuser to achieve more uniform and softer light, providing more comfortable visual experience. Luminous efficiency 105lm/W. Powder spraying surface treatment is employed in the lamp fixture which makes the lamp corrosion resistant. Designed for grid ceiling commercial applications.

- ▶ 120°
- ▶
- ▶
- ▶

Code	Watt	Size(AxBxCmm)	Cut-out(±5mm)	Lumen(±5%)	N.W/pc(kgs)	Q'ty/CTN
JGL6060-33W-N	33W	595x595x54	580x580	3850lm	2.50	5PCS
JGL30120-33W-N	33W	1195x295x54	1180x280	3850lm	2.70	5PCS

CCT — 3000K 4000K 5000K 5700K

Finish — White

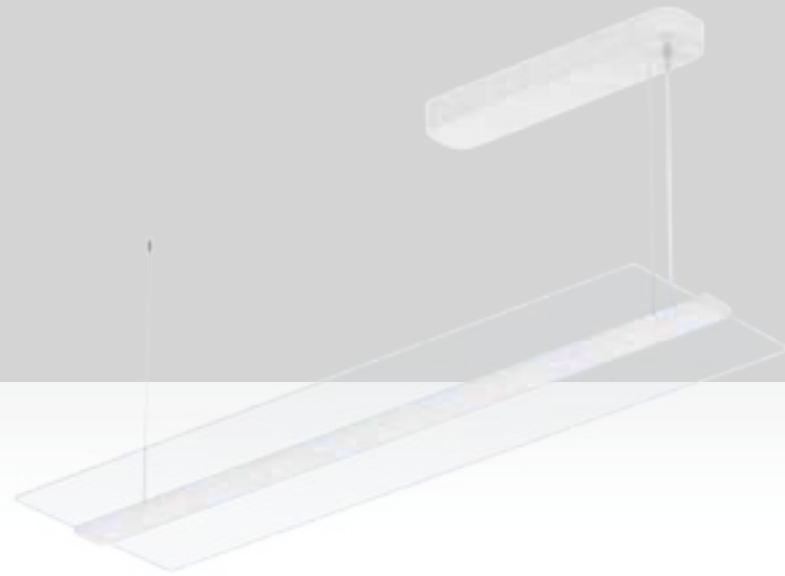

## JPL-DF Panel light

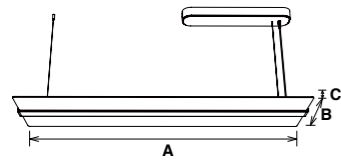

This panel light is a frameless, transparent and 360 degree lighting design, which provides a great visual aesthetic feeling. Adopt high lumen SMD light source, the 4mm transparent PMMA LGP makes a uniform, soft lighting output and reaches anti-glare UGR<19. 6063 aluminum heat sink makes an excellent thermal management. Magnetic mounting box can also save much time for installation.

- ▶ 360° 50% IP20 UGR<19
- ▶ DIM DALI SMD SWITCH 2 in 1
- ▶ AC 200-240V PF≥0.9 CRI≥80
- ▶ RoHS CE

Code	Watt	Size(AxBxCmm)	Cut-out(±5mm)	Lumen(±5%)	N.W/pc(kgs)	Q'ty/CTN
JPL35120-40W-DF	40W	1200x350x19	/	4800lm	4.50	2PCS
JPL35120-40W-DF-D	40W	1200x350x19	/	4800lm	4.50	2PCS
JPL35120-60W-DF	60W	1200x350x19	/	7200lm	4.50	2PCS

CCT ——— 3000K ——— 4000K ——— 5700K

Finish ——— White

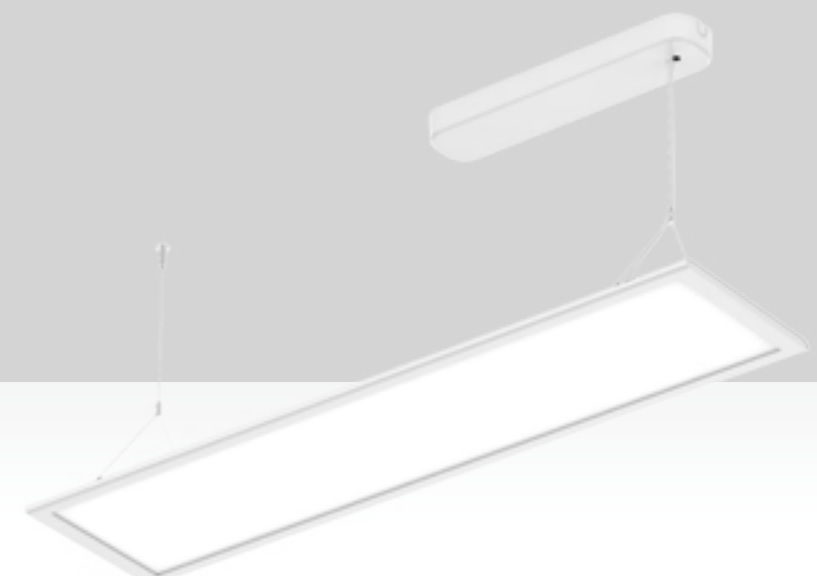

## JPL-DB Panel light

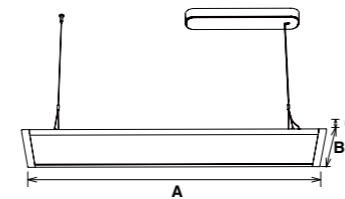

JPL-DB panel light is an Up & down emitting panel with external driver, novel design without any screw make it a special and good looking panel. Besides, it is an anti-glare UGR<19 design without Prism plate, this is a new tendency for high end market. Magnetic mounting box can also save much time for installation, Triac dim and DALI dimming options.

- ▶ 110° IP20 UGR<19
- ▶ DIM DALI
- ▶ AC 220-240V PF≥0.9 CRI≥80
- ▶ RoHS CE

Code	Watt	Size(AxBxCmm)	Cut-out(±5mm)	Lumen(±5%)	N.W/pc(kgs)	Q'ty/CTN
JPL30120-30W-DB	30W	1200x300x16.5	/	3060lm	3.76	2PCS
JPL30120-40W-DB	40W	1200x300x16.5	/	4000lm	3.76	2PCS
JPL30120-50W-DB	50W	1200x300x16.5	/	4950lm	3.76	2PCS

CCT ——— 3000K ——— 4000K ——— 5000K ——— 5700K

Finish ——— White



## JPL-W Panel light

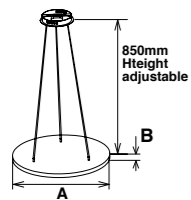

JPL-W LED pendant decorative light with high quality diffuser and 3T PMMA LGP. 300mm, 400mm, 500mm, 600mm and 780mm diameter for options. Various installation ways include suspended, surface mounted and recessed.

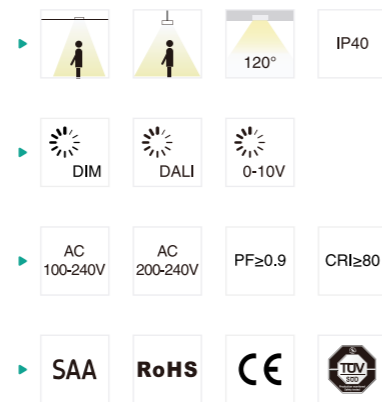

Code	Watt	Size(AxBmm)	Lumen(±5%)	N.W/pc(kgs)	Q'ty/CTN
JPL3012-18W-W	18W	Ø300x12	1560lm	2.50	5PCS
JPL4012-25W-W	25W	Ø400x12	2070lm	3.10	4PCS
JPL4012-35W-W	35W	Ø400x12	2900lm	3.10	4PCS
JPL5012-30W-W	30W	Ø500x12	2520lm	4.20	4PCS
JPL5012-35W-W	35W	Ø500x12	2900lm	4.20	4PCS
JPL6012-35W-W	35W	Ø600x12	3040lm	4.34	2PCS
JPL6012-45W-W	45W	Ø600x12	3600lm	4.34	2PCS
JPL8012-60W-W	60W	Ø780x20	5430lm	6.10	2PCS
JPL8012-80W-W	80W	Ø780x20	7460lm	6.90	2PCS

CCT 3000K 4000K 5000K 5700K

Finish White



## JPL-DD Panel light

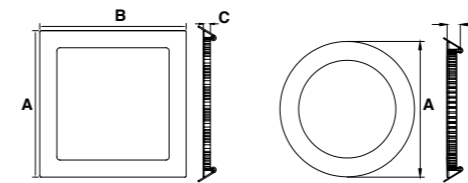

JPL-DD is small size panel with complete diameter options. 2835SMD LED chip and PMMA LGP offer a great light transmittance and light output. Adopt die-casting aluminum frame which provides a great thermal management. External driver comes with triac dim, it shares great popularity by perfect dimming range and great compatibility with worldwide dimmers. The ultra slim profile fits perfectly for all working places.

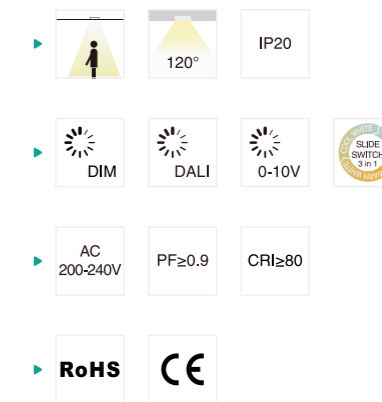

Code	Watt	Size(AxBxCmm)	Cut-out(±5mm)	Lumen(±5%)	N.W/pc(kgs)	Q'ty/CTN
JPL1212-7W-DD	7W	120x120x21	105x105	525lm	0.24	36PCS
JPL1515-9W-DD	9W	146x146x21	127x127	750lm	0.28	24PCS
JPL1717-12W-DD	12W	171x171x21	155x155	950lm	0.34	20PCS
JPL2222-18W-DD	18W	224x224x21	205x205	1500lm	0.52	12PCS
JPL3030-24W-DD	24W	300x300x21	277x277	2000lm	0.88	12PCS
JPL1221-7W-DD	7W	Ø120x21	Ø108-113	525lm	0.20	36PCS
JPL1521-9W-DD	9W	Ø145x21	Ø127-133	750lm	0.24	24PCS
JPL1721-12W-DD	12W	Ø170x21	Ø157-162	950lm	0.29	20PCS
JPL2221-18W-DD	18W	Ø224x21	Ø205-212	1500lm	0.42	12PCS
JPL3021-24W-DD	24W	Ø300x21	Ø282-288	2000lm	0.71	12PCS

CCT 3000K 4000K 5000K 5700K 6500K

Finish White



## Panel Light installation accessories

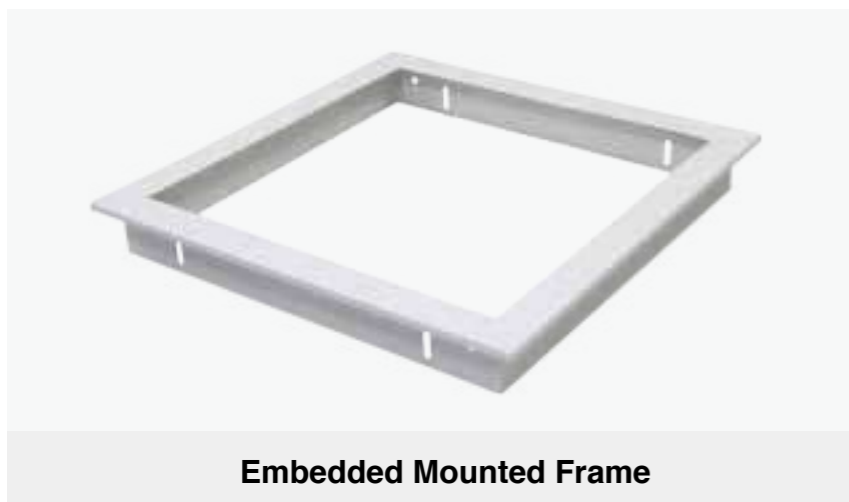



# LED Linear Batten Light

/Series/

LED batten series and linear light are more and more popular nowadays. The original design concept is to replace the LED tube. But LED batten is more decorative and elegant, while it also maintains high lumen efficiency. Jibe Lighting is committed to the design and development of LED battens for many years. Multiple functions are updated constantly: UGR<19, 100lm/W, 120lm/W, lighting up&down, as well as DALI or 0-10v dimmable system. Surface mounted, suspended and wall mounted are all available.



# JDB66 Linear light

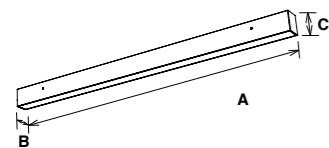

The JDB66A/B is a new linkable design light. Adopt high lumen efficiency SMD LED and aluminum materials. Pendant, surface mounted, wall mounted installation available. Up and down light effect of wall mounted and pendant installation. Interchangeable CCT, DALI/0-10V dimming for options. Tridonic DALI driver available.

- ▶
- ▶
- ▶
- ▶

Code	Watt	Size(AxBxCmm)	Lumen(±5%)	N.W/pc(kgs)	Q'ty/CTN
JDB66A-1200-36W	36W	1204x56x75	4000lm	2.75	6PCS
JDB66A-1200-50W	50W	1204x56x75	5250lm	2.75	6PCS
DB66A-1500-42W	42W	1504x56x75	4800lm	3.35	6PCS
JDB66A-1500-60W	60W	1504x56x75	6500lm	3.35	6PCS
JDB66B-1200-36W	36W	1204x56x75	3950lm	2.75	6PCS
JDB66B-1200-50W	50W	1204x56x75	5300lm	2.75	6PCS
JDB66B-1500-42W	42W	1504x56x75	4600lm	3.35	6PCS
JDB66B-1500-60W	60W	1504x56x75	6600lm	3.35	6PCS

CCT — 3000K — 4000K — 5000K — 5700K

Finish — White Black

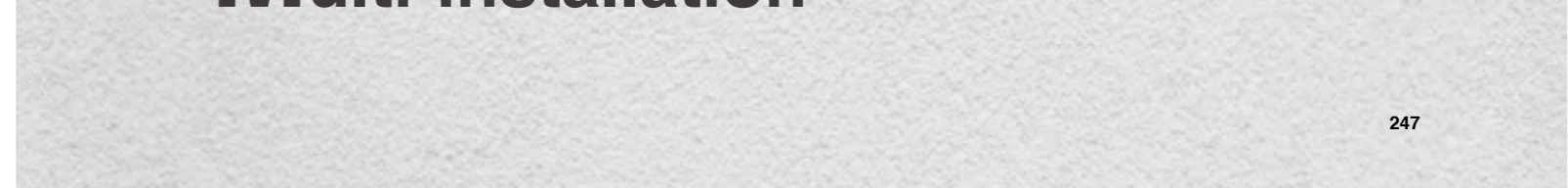
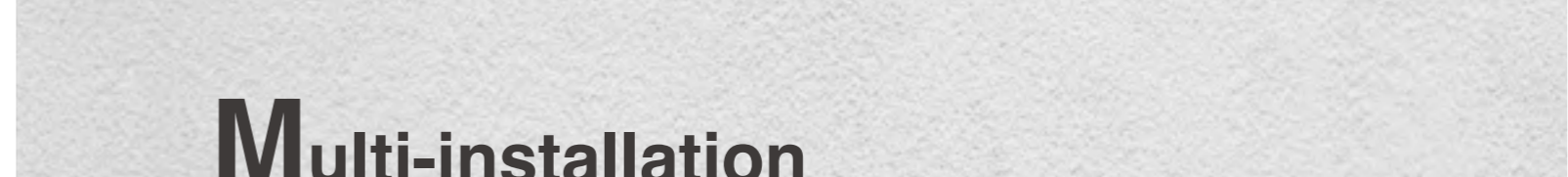
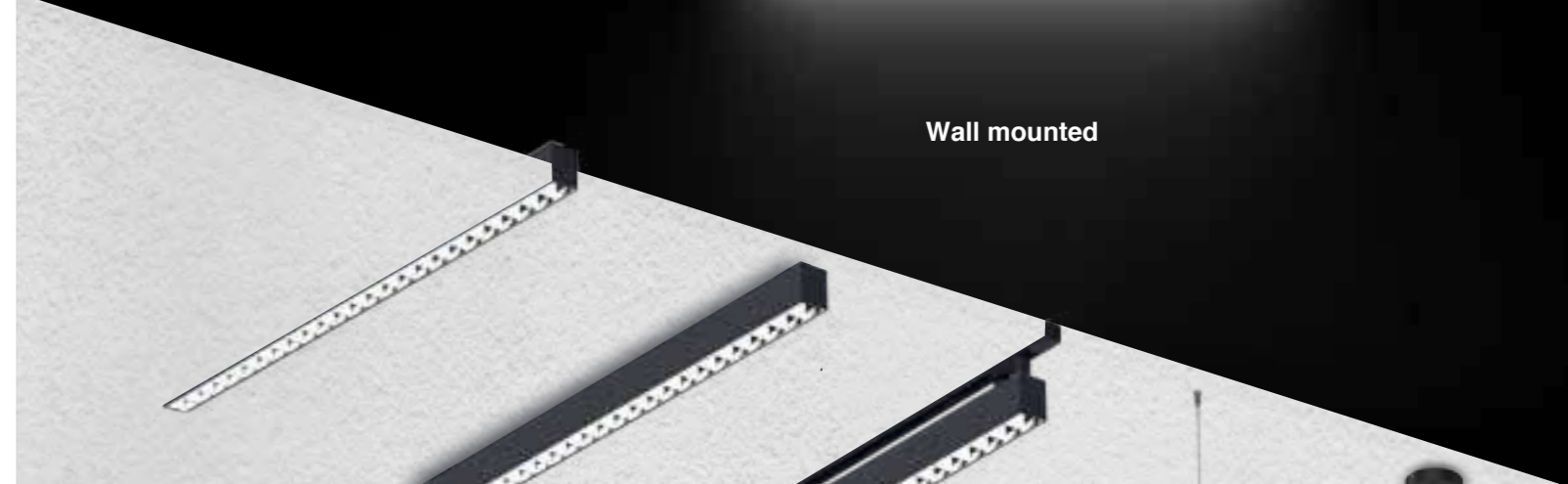

## Multi-installation

LED Linear & Batten light

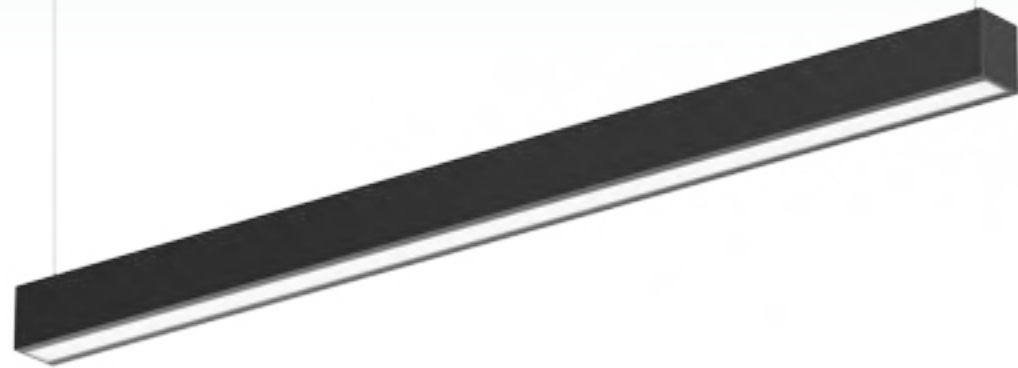

# JDB45 Linear light

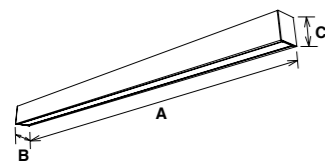

Module changeable design LED batten JDB45 provides good heat dissipation, quality light and substantial energy saving. Suspended, surface mounted and splicing installation optional.

- ▶ 100° IP20
- ▶ SLIM SWITCH 3 in 1
- ▶ AC 200-240V PF ≥ 0.9 CRI ≥ 80
- ▶ RoHS CE

Code	Watt	Size(AxBxCmm)	Lumen(±5%)	N.W/pc(kgs)	Q'ty/CTN
JDB45A-600-20W	20W	604x60x70	2500lm	1.15	21PCS
JDB45A-1200-40W	40W	1204x60x70	5200lm	2.20	20PCS
JDB45B-600-20W	20W	604x60x70	2400lm	1.15	21PCS
JDB45B-1200-40W	40W	1204x60x70	4800lm	2.20	20PCS

CCT — 3000K 4000K 5000K 5700K

Finish — White Black

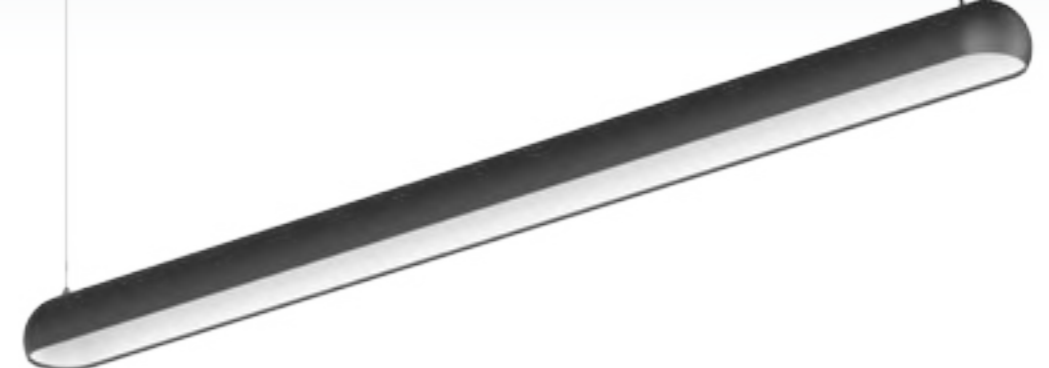

# JDB60 Linear light

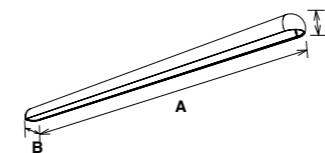

JDB60 is a double-side luminaire, with semicircle structure design. The combination of lens and reflector makes luminaire UGR < 19.

- ▶ 110°/60° IP20 UGR < 19
- ▶ AC 220-240V PF ≥ 0.9 CRI ≥ 80
- ▶ SAA RoHS CE

Code	Watt	Size(AxBxCmm)	Lumen(±5%)	N.W/pc(kgs)	Q'ty/CTN
JDB60-1200-40W	40W	1206x81x61	4800lm	2.30	6PCS
JDB60-1600-60W	60W	1652x81x61	7200lm	2.90	6PCS

CCT — 3000K 4000K 5000K 5700K

Finish — White Black

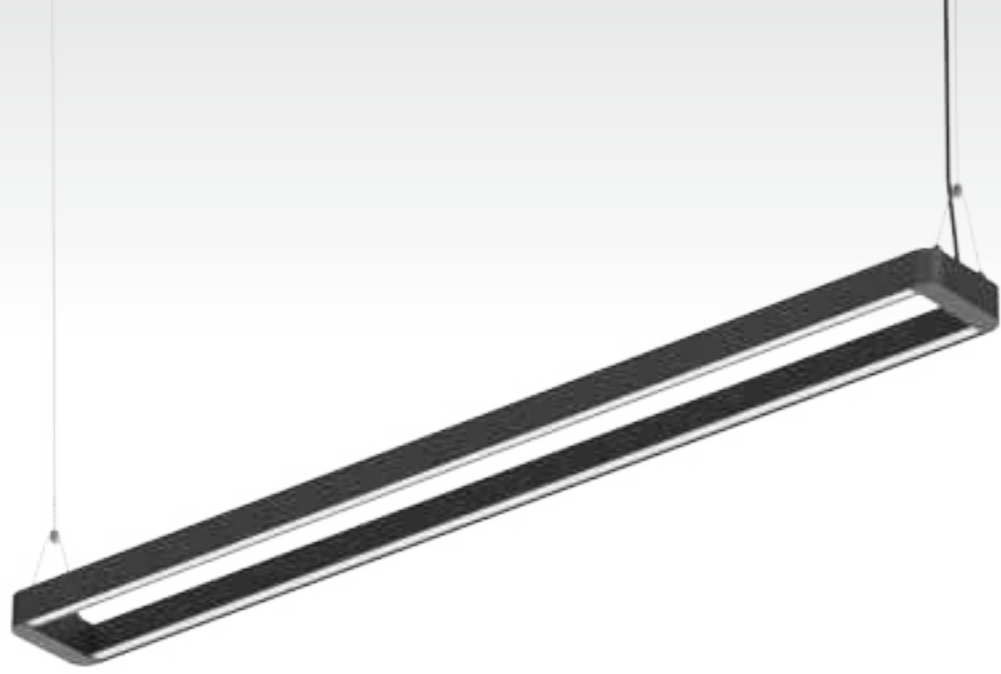

# JDB59 Linear light

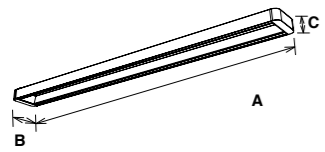

JDB59 linear light is a double-side luminaire with hollow design. Opal and grille modules are optional for both sides. The UGR<19 version provides comfortable lighting.

- ▶ 110° 60°
- ▶ 110° 60°
- ▶ IP20
- ▶ UGR<19
- ▶ AC 220-240V
- ▶ PF≥0.9
- ▶ CRI≥80

- ▶ RoHS
- ▶ CE



DB59A DB59B DB59C

Code	Watt	Size(AxBxCmm)	Lumen(±5%)	N.W/pc(kgs)	Q'ty/CTN
JDB59A-1200-30W	30W	1200x120x40	4200lm	2.40	5PCS
JDB59A-1500-40W	40W	1583x120x40	5600lm	2.80	5PCS
JDB59B-1200-30W	30W	1200x120x40	3200lm	2.40	5PCS
JDB59B-1500-40W	40W	1583x120x40	4200lm	2.80	5PCS
JDB59C-1200-40W	40W	1200x120x40	5000lm	2.40	5PCS
JDB59C-1500-60W	60W	1583x120x40	7000lm	2.80	5PCS

CCT — 3000K 4000K 5000K 5700K

Finish — White Black

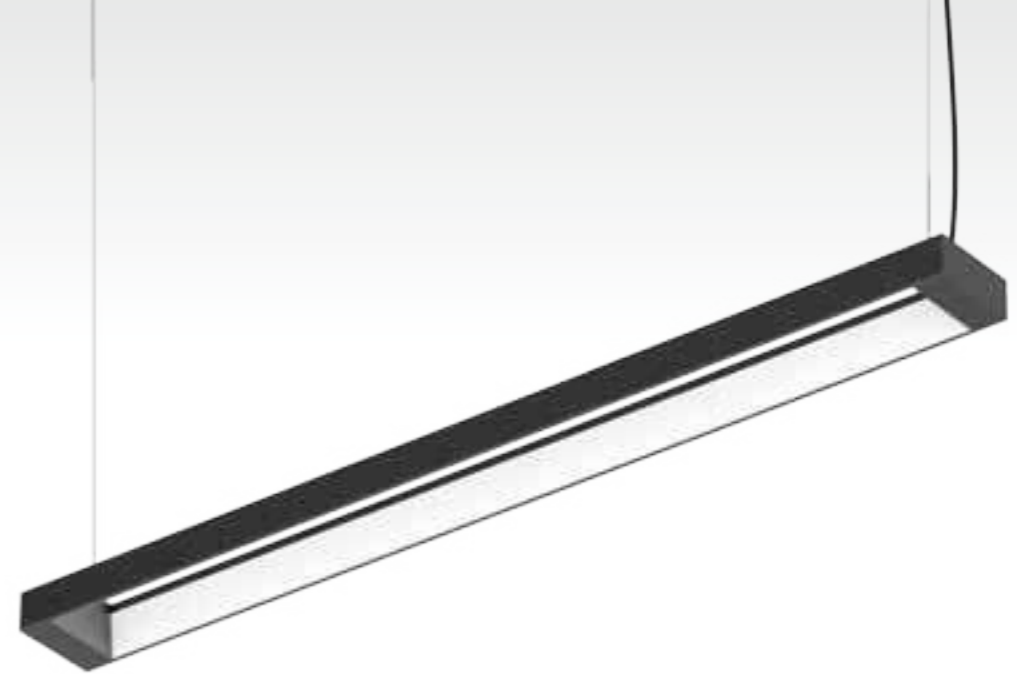

# JDB25 Linear light

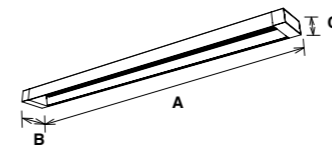

JDB25 Linear with suspended and hollow design highlight the brand features, which makes the light go both up and down sides. The light for upside can reduce the extra light decoration.

- ▶ 120°
- ▶ IP20
- ▶ SLIDE SWITCH 3 in 1

- ▶ AC 200-240V
- ▶ PF≥0.9
- ▶ CRI≥80

- ▶ RoHS
- ▶ CE

Code	Watt	Size(AxBxCmm)	Lumen(±5%)	N.W/pc(kgs)	Q'ty/CTN
JDB25-900-20W	20W	922x115x48.8	2000lm	1.46	6PCS
JDB25-1200-40W	40W	1222x115x48.8	3800lm	1.86	6PCS
JDB25-1600-60W	60W	1622x115x48.8	5800lm	2.47	6PCS



# JDB106 Batten

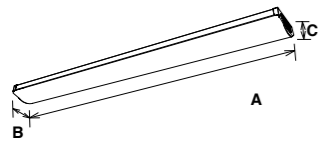

JDB106 is an extra wide-body LED batten featuring an aesthetically pleasing low-glare design that minimises ceiling clutter for offices, retail and schools applications. Multi-functions as emergency and sensor available. It can be only for surface mounted installation.

- ▶ 120° IP40
- ▶ DIM DALI
- ▶ AC 200-240V PF≥0.9 CRI≥80
- ▶ SAA CE

Code	Watt	Size(AxBxCmm)	Lumen(±5%)	N.W/pc(kgs)	Q'ty/CTN
JDB106-1200-25W	25W	1200x210x70	2900lm	3.80	4PCS
JDB106-1200-30W	30W	1200x210x70	3500lm	3.80	4PCS
JDB106-1200-40W	40W	1200x210x70	4600lm	3.80	4PCS
JDB106-1500-40W	40W	1500x210x70	4850lm	4.70	4PCS
JDB106-1500-50W	50W	1500x210x70	6000lm	4.70	4PCS
JDB106-1500-58W	58W	1500x210x70	7000lm	4.70	4PCS

CCT — 3000K — 4000K — 5000K

Finish — White





# JTRP06 Linear light

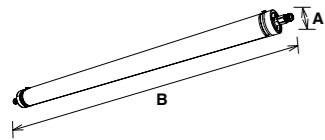

JTRP06 adopts high lumen SMD chip, the high transmittance PC cover makes a uniform and soft light output. With waterproof joint at both ends, it can be linkable. Special clip-on bracket design makes an easier installation. The installation angle is adjustable with different scales.

- ▶ IP69K IP66
- ▶ DALI 0-10V
- ▶ AC 220-240V PF ≥ 0.9 CRI ≥ 80
- ▶ CE

Code	Watt	Size(AxBmm)	Lumen(±5%)	N.W/pc(kgs)	Q'ty/CTN
JTRP06A-600-20W	20W	Ø75.2x600	2350lm	0.96	6PCS
JTRP06B-600-20W	20W	Ø75.2x600	2350lm	0.96	6PCS
JTRP06A-1200-33W	33W	Ø75.2x1200	4150lm	1.65	6PCS
JTRP06B-1200-33W	33W	Ø75.2x1200	4150lm	1.65	6PCS
JTRP06A-1500-45W	45W	Ø75.2x1500	5500lm	2.00	6PCS
JTRP06B-1500-45W	45W	Ø75.2x1500	5500lm	2.00	6PCS

CCT 
3000K
4000K
5000K
5700K

Finish 
White



## IP69K TUBULAR Tri-proof batten

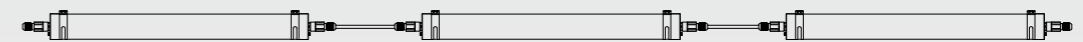

ART-NR	20W	33W	45W
Linkable suggested luminaries Qty	JAC200-240V 52	42	35



# JDB68 Batten

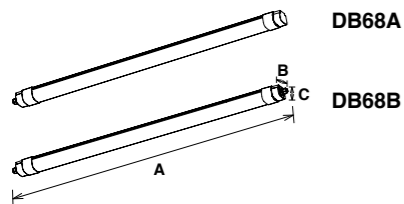

JDB68 is an IP66 waterproof IK10 rated luminaire. Adopt 3x2 poles push in wire terminal block. It provides through-wiring for further luminaires (safety class II) connection. Tool free mains cable installation on both sides.

- ▶
- ▶
- ▶

Code	Watt	Size(AxBxCmm)	Lumen(±5%)	N.W/pc(kgs)	Q'ty/CTN
JDB68A-700-20W	20W	700x78.3x58.6	2300lm	0.50	12PCS
JDB68A-1300-40W	40W	1300x78.3x58.6	4680lm	0.80	8PCS
JDB68A-1600-50W	50W	1600x78.3x58.6	6000lm	0.95	6PCS
JDB68B-700-20W	20W	700x78.3x58.6	2300lm	0.50	12PCS
JDB68B-1300-40W	40W	1300x78.3x58.6	4680lm	0.80	8PCS
JDB68B-1600-50W	50W	1600x78.3x58.6	6000lm	0.95	6PCS

CCT — 3000K 4000K 5000K 5700K — Finish — White Black

Linkable suggested luminaires Qty (200-240V) — 20W-52PCS 40W-26PCS 50W-21PCS



# JDB18 Batten

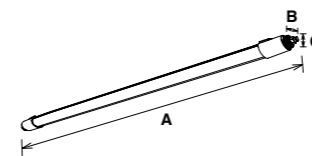

JDB18 is a high quality LED batten with high luminous efficacy 115lm/w. With a reliable and robust housing structure (IK10 & IP66). Three options of length (700mm/1300mm/1600mm), and various lumen package, let it to be an ideal replacement for traditional fluorescent batten.

- ▶
- ▶
- ▶
- ▶

Code	Watt	Size(AxBxCmm)	Lumen(±5%)	N.W/pc(kgs)	Q'ty/CTN
JDB18-700-20W	20W	700x78x53.5	2300lm	0.60	12PCS
JDB18-1300-25W	25W	1300x78x53.5	3050lm	0.80	8PCS
JDB18-1300-30W	30W	1300x78x53.5	3450lm	0.80	8PCS
JDB18-1300-40W	40W	1300x78x53.5	4680lm	0.80	8PCS
JDB18-1600-40W	40W	1600x78x53.5	4680lm	1.00	6PCS
JDB18-1600-50W	50W	1600x78x53.5	6000lm	1.00	6PCS

CCT — 3000K 4000K 5000K 5700K — Finish — White Black

Linkable suggested luminaires Qty (200-240V) — 20W-52PCS 40W-26PCS 50W-21PCS





# JDB76 Batten

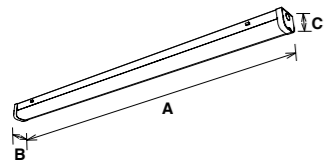

The iron lamp body provides excellent heat dissipation. It is made of high lumen 2835 SMD led chips, energy saving, instant start. New plastic snap-on button design for easy installation.

- ▶ 120° IP20
- ▶ SLIDE SWITCH 3m PIR Sensor Smart Lighting
- ▶ AC 200-240V PF≥0.9 CRI≥80
- ▶ SAA RoHS CE

Code	Watt	Size(AxBxCmm)	Lumen(±5%)	N.W/pc(kgs)	Q'ty/CTN
JDB76-600-20W	20W	603X71X64	2200lm	7.8	12PCS
JDB76-1200-40W	40W	1203X71X64	4600lm	15.4	12PCS
JDB76-1500-50W	50W	1503X71X64	6000lm	18.7	12PCS
JDB76-1500-58W	58W	1503X71X64	6500lm	18.7	12PCS
JDB76-1800-58W	50W	1803X71X64	7000lm	13.2	6PCS
JDB76-1800-72W	72W	1803X71X64	8350lm	13.2	6PCS

CCT 3000K 4000K 5000K 5700K

Finish White Black

# JDB08 Batten

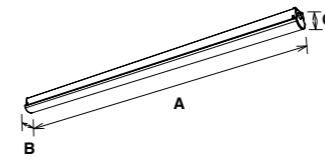

The design of JDB08 batten realizes low cost, simple construction and superior capability, milky PC diffuser achieves anti-glare and high light transmittance. It is a high efficient and low cost product with quite large potential market.

- ▶ 120° IP20
- ▶ ((...))
- ▶ AC 100-277V PF≥0.9 CRI≥80
- ▶ SAA RoHS CE

Code	Watt	Size(AxBxCmm)	Lumen(±5%)	N.W/pc(kgs)	Q'ty/CTN
JDB08-600-20W	20W	625X58.5X58.5	2060lm	0.78	10PCS
JDB08-1200-40W	40W	1225X58.5X58.5	3960lm	1.50	10PCS
JDB08-1500-45W	45W	1525X58.5X58.5	4860lm	1.90	6PCS

CCT 3000K 4000K 5000K 5700K

Finish White Black



# JDB41 Batten

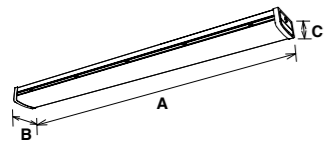

JDB41 batten lamp adopts separated module design, has been improved to have a wider lighting emitting area; color temperature and wattage both switchable. Suspended, surface mounted and splicing installation optional.

- ▶ 120° IP20
- ▶ SLIDE SWITCH 3 in 1 Adjustable Power
- ▶ AC 200-240V PF≥0.9 CRI≥80
- ▶ SAA RoHS CE

Code	Watt	Size(AxBxCmm)	Lumen(±5%)	N.W/pc(kgs)	Q'ty/CTN
JDB41-600-25W	25W	600x124x68	2500lm	1.50	12PCS
JDB41-1200-42W	42W	1200x124x68	4780lm	2.90	6PCS

CCT — 3000K 4000K 5000K 5700K

Finish — White Black

# JDB61 Batten

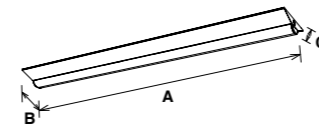

JDB61 is a modular design led batten light with narrow and wide base version for option. Even lighting with high lighting efficiency 120~130lm/w. Seamless line connection, ideally product for different applications. It offers multiple functions such as CCT changeable and wattage switchable. Metal base with perfect heating dissipation to ensure the longer lifespan.

- ▶ 120° IP20
- ▶ AC 200-240V PF≥0.9 CRI≥80
- ▶ SAA RoHS CE

Code	Watt	Size(AxBxCmm)	Lumen(±5%)	N.W/pc(kgs)	Q'ty/CTN
JDB61A-600-20W	20W	630X150X58.5	2550lm	1.42	5PCS
JDB61-600-20W	20W	630X230X58.5	2550lm	1.70	5PCS
JDB61A-1200-40W	40W	1250X150X58.5	5012lm	2.70	5PCS
JDB61-1200-40W	40W	1250X230X58.5	5012lm	3.20	5PCS

CCT — 3000K 4000K 5000K 5700K

Finish — White Black



# JDB49 Batten

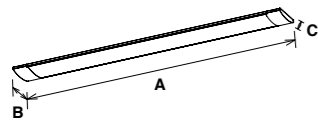

Full size slim batten JDB49 featuring uniform light and excellent heat dissipation, CCT changeable by adjusting the slide switch. Easier installation without installing bracket.

- ▶ 120° IP20
- ▶ SLIDE SWITCH 3 in 1
- ▶ AC 200-240V PF≥0.9 CRI≥80
- ▶ SAA RoHS CE

Code	Watt	Size(AxBxCmm)	Lumen(±5%)	N.W/pc(kgs)	Q'ty/CTN
JDB49A-600-20W	20W	600X80X34	2300lm	0.60	10PCS
JDB49A-900-30W	30W	900X80X34	3400lm	0.86	10PCS
JDB49A-1200-35W	35W	1200X80X34	3900lm	1.12	10PCS
JDB49A-1500-40W	40W	1500X80X34	4300lm	1.40	6PCS
JDB49B-600-25W	25W	600X124X42	2800lm	0.84	10PCS
JDB49B-900-35W	35W	900X124X42	4100lm	1.25	10PCS
JDB49B-1200-45W	45W	1200X124X42	5500lm	1.67	10PCS
JDB49B-1500-50W	50W	1500X124X42	5500lm	2.00	6PCS

CCT — 3000K 4000K 5000K 5700K

Finish — White Black



# JAL17/-F Batten

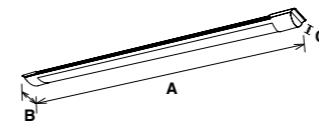

Jibe Lighting's IP65 weatherproof batten which available in 21W & 42W with size of 600mm and 1200mm. Featuring high grade polycarbonate diffuser and housing, they are suitable for commercial and industrial use where moisture or dust is prevalent.

- ▶ 110° IP65 IP20
- ▶ AC 100-240V AC 100-277V PF≥0.9 CRI≥80
- ▶ SAA RoHS CE

Code	Watt	Size(AxBxCmm)	Lumen(±5%)	N.W/pc(kgs)	Q'ty/CTN
JAL17-600-21W	21W	600x75x24	1950lm	0.35	25PCS
JAL17-900-32W	32W	900x75x24	2850lm	0.51	25PCS
JAL17-1210-42W	42W	1210x75x24	3820lm	0.67	20PCS
JAL17F-600-21W	21W	600x78x28	1760lm	0.45	25PCS
JAL17F-1210-42W	42W	1210x78x28	3570lm	0.75	25PCS

CCT — 3000K 4000K 5000K 5700K

Finish — White Black



## JDB05 Batten

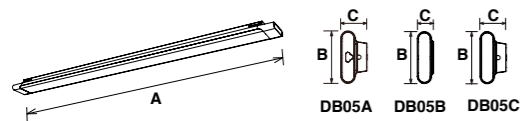

Elegant design, low cost, super slim construction and superior capability, aluminum profile body for good thermal dissipate. Easy installation provided with surface mounted and suspended.

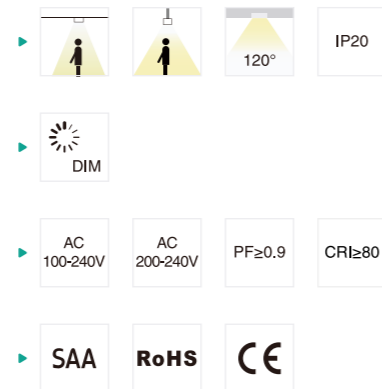

Code	Watt	Size(AxBxCmm)	Lumen(±5%)	N.W/pc(kgs)	Q'ty/CTN
JDB05A/C-600-20W	20W	600X90X46	1710lm	0.86	12PCS
JDB05A/C-900-30W	30W	900X90X46	2630lm	1.30	12PCS
JDB05A/C-1200-40W	40W	1200X90X46	3540lm	1.98	12PCS
JDB05B-600-20W	20W	600X90X28	1710lm	0.82	20PCS
JDB05B-900-30W	30W	900X90X28	2630lm	0.95	12PCS
JDB05B-1200-40W	40W	1200X90X28	3540lm	1.50	12PCS

CCT — 3000K — 4000K — 5000K — 5700K

Finish — White Black



## JDB15B Batten

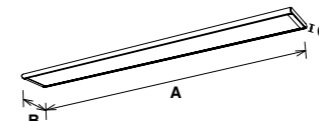

JDB15B suspending led batten light designed with 270° wide beam angle. Distribute 60% lumens downwards to satisfying the basic requirement for activities and 40% lumens upwards to creating a brilliant lighting atmosphere.  
Code Watt Size (AxBxCmm)

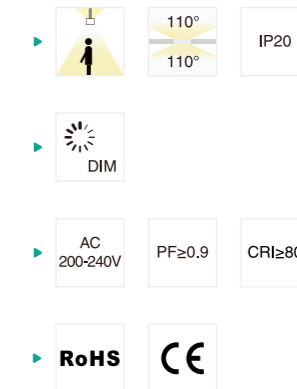

Code	Watt	Size(AxBxCmm)	Lumen(±5%)	N.W/pc(kgs)	Q'ty/CTN
JDB15B-600-20W	20W	600x148x17	1400lm	1.60	6PCS
JDB15B-900-30W	30W	900x148x17	2250lm	1.90	6PCS
JDB15B-1200-45W	45W	1200x148x17	2790lm	2.30	6PCS

CCT — 3000K — 4000K — 5000K — 5700K

Finish — White Black



# JAL06 Batten

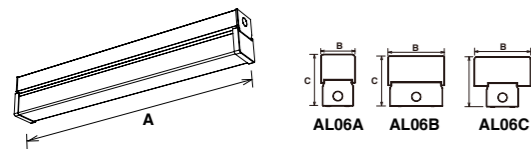

AA12 prismatic diffuser for visual comfort. Cover plate held securely by threaded nut for fast installation. High quality white epoxy powder coated finish. New plastic snap-on end caps for easy installation of diffuser.

- ▶ IP20
- ▶
- ▶ AC 100-277V PF ≥ 0.9 CRI ≥ 80
- ▶ SAA RoHS CE

Code	Watt	Size(AxBxCmm)	Lumen(±5%)	N.W/pc(kgs)	Q'ty/CTN
JBDLAL06-9W-A	9W	624X69X105	800lm	1.20	12PCS
JBL-AL06-18W-A	18W	1232X69X105	1630lm	2.40	8PCS
JBL-AL06-25W-A	25W	1535X69X105	2120lm	3.00	6PCS
JBL-AL06-18W-B/C	18W	624X120X108	1630lm	1.80	8PCS
JBL-AL06-36W-B/C	36W	1232X120X108	3250lm	3.60	4PCS
JBL-AL06-50W-B/C	50W	1535X120X108	4300lm	4.50	4PCS

CCT 3000K 4000K 5000K 5700K

Finish White Black



# JTRP03 Batten

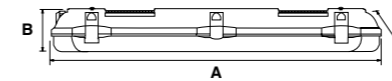

Traditional tube replacement TRP03 with high transparency, soft&uniform light distribution; latch design make the lampshade dis-assembly and assembly easier. Dust-proof waterproof rating as IP65. Anti-corrosion, shock resistance, easy cleaning, energy saving and environmental protection. Brand Tridonic driver available.

- ▶ IP65
- ▶
- ▶ AC 220-240V PF ≥ 0.9 CRI ≥ 80
- ▶ RoHS CE

Code	Watt	Size(AxBxCmm)	Lumen(±5%)	N.W/pc(kgs)	Q'ty/CTN
JTRP03-600-10W Single	10W	660x90x90	100/130 LM/W	0.90	12PCS
JTRP03-600-19W/E Twin	19W	664x140x90	100/130 LM/W	1.16/1.35	9PCS
JTRP03-1200-19W Single	19W	1274x90x90	100/130 LM/W	1.62	9PCS
JTRP03-1200-38W/E Twin	38W	1274x140x90	100/130 LM/W	2.26/2.60	6PCS
JTRP03-1500-38W Single	38W	1574x90x90	100/130 LM/W	1.96	9PCS
JTRP03-1500-57W/E Twin	57W	1574x140x90	100/130 LM/W	2.65/3.15	6PCS
JTRP03-1800-38W Single	38W	1837x90x90	100/130 LM/W	2.29	6PCS
JTRP03-1800-75W/E Twin	75W	1837x140x90	100/130 LM/W	3.09/3.95	4PCS

CCT 3000K 4000K 5000K 5700K

Finish White

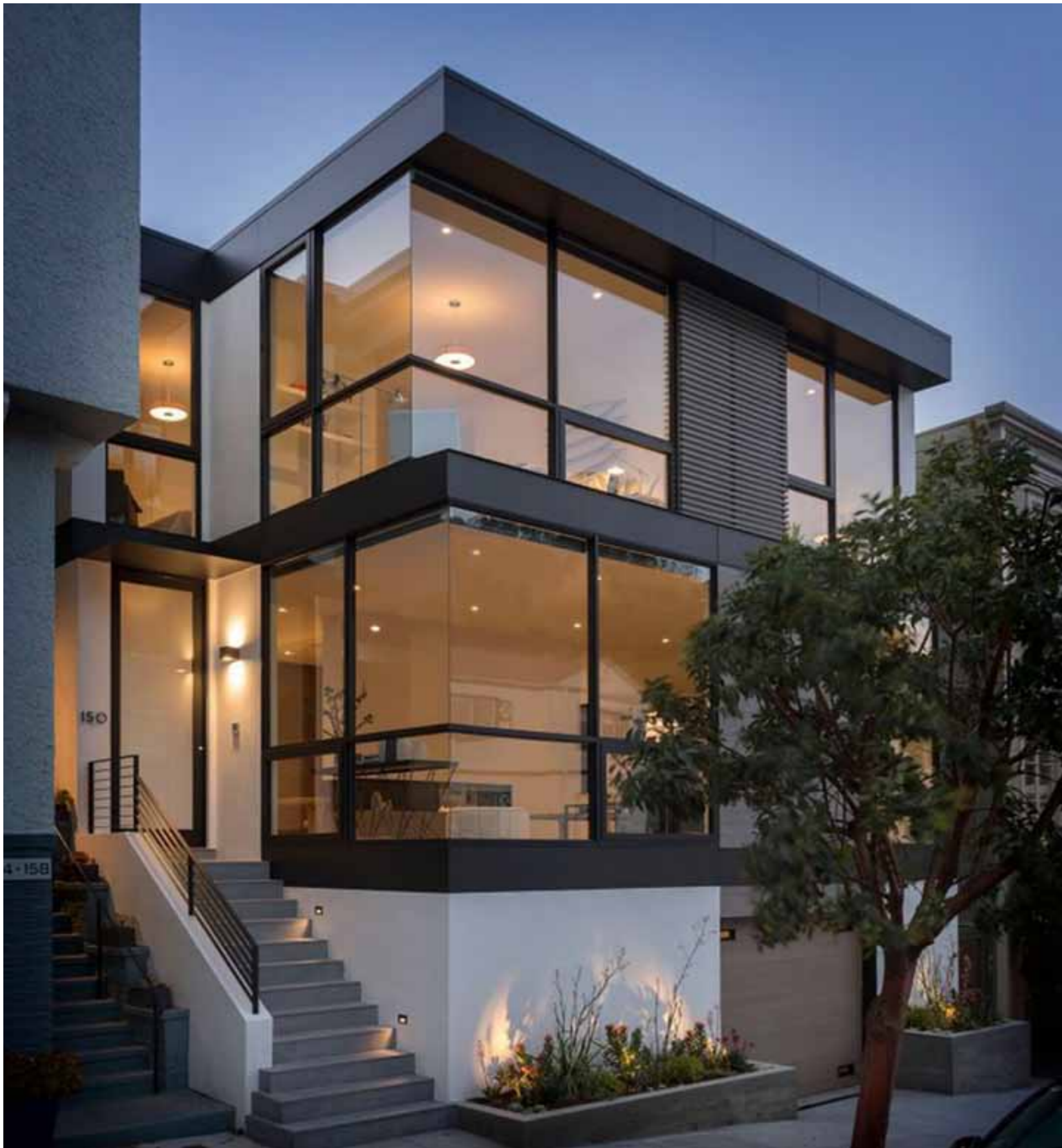

# LED Wall & Spike Light

/Series/

*Jibe Lighting has been developing a series of wall lights and spike lights in recent years. More and more fashionable and brilliant products are self-designed. Equipped with new sensor function, up and down lighting, beam angle adjustable version, and IP65 waterproof, Jibe lighting ed wall light family provide various solutions for project and distribution. All wall lights can be used for both indoor corridors and outdoor courtyard. Jibe Lighting has received much favor and love from our customers.*



# JWL46 Wall light

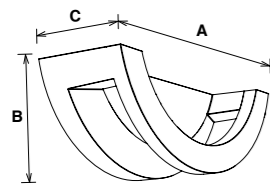

JWL46 LED wall light wins 2020 IF Award, adopting high lumen SMD, aluminum body with great thermal management. It is IP65 IK08 high protection. Indirect lighting design offers a great visual experience. Various DIY shape is available.

- ▶ 50°
- ▶ AC 200-240V PF≥0.9 CRI≥80
- ▶

Code	Watt	Size(AxBxCmm)	Lumen(±5%)	N.W/pc(kgs)	Q'ty/CTN
JWL46-10W	10W	204x81x78	530lm	0.50	24PCS

CCT ——— 3000K 4000K 5000K 5700K

Finish ——— Black

Indirect lighting like  
**RAINBOW**  
DIY shape installation





## JWL57 Wall light

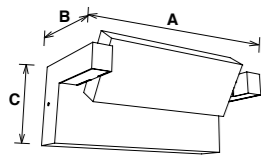

JWL57 wall light is with adjustable head 240 degree (30 degree clockwise, 210 degree counterclockwise). ADC12 aluminum housing provides an excellent thermal management. IP65 and IK10 rating for outdoor lighting. A type frosted tempered glass and B type clear tempered glass.

- ▶ IP65
- ▶ AC 200-240V PF≥0.9 CRI≥80
- ▶ SAA RoHS CE

Code	Watt	Size(AxBxCmm)	Lumen(±5%)	N.W/pc(kgs)	Q'ty/CTN
JWL57A-10W	10W	203x108x80	1050lm	0.85	12PCS
JWL57B-10W	10W	203x108x80	1200lm	0.85	12PCS
JWL57A-18W	18W	203x108x80	1800lm	0.85	12PCS
JWL57B-18W	18W	203x108x80	2000lm	0.85	12PCS

CCT 3000K 4000K 5000K 5700K

Finish White Black



## JWL28 Wall light

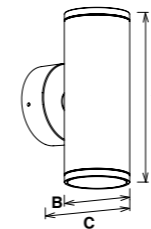

JWL28 as one of the wall light UP and DOWN in Jibe Lighting which is IP65 and IK08 with AL6063 aluminum and UV resistance for outdoor application, the wide voltage 100~240V could be used in all of the world. Meanwell, the isolated driver and high light efficiency wins lots of good feedback from market.

- ▶ IP65
- ▶ AC 100-240V PF≥0.9 CRI≥80
- ▶ SAA RoHS CE

Code	Watt	Size(AxBxCmm)	Lumen(±5%)	N.W/pc(kgs)	Q'ty/CTN
JWL28-10W	10W	170x60x105	900lm	0.60	18PCS
JWL28-20W	20W	200x76x121	2200lm	0.90	18PCS
JWL28-27W	27W	230x100x145	3200lm	1.20	12PCS

CCT 2700K 3000K 4000K 5000K

Finish White Black Silver



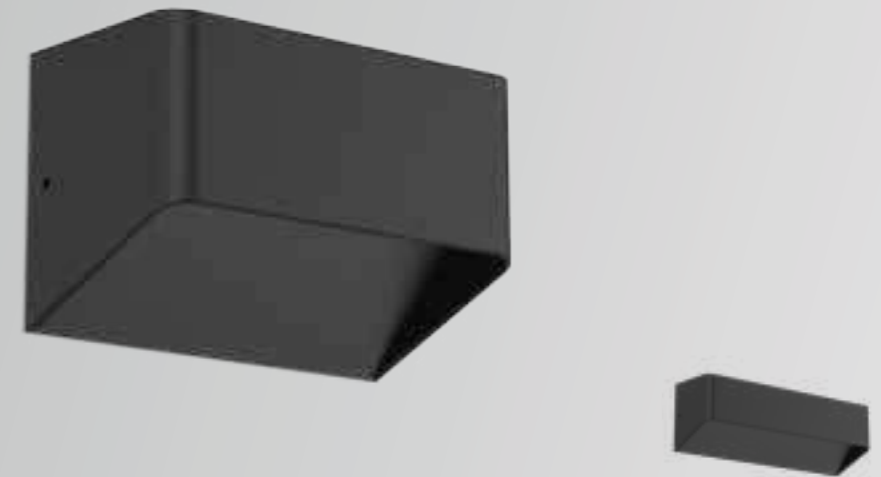
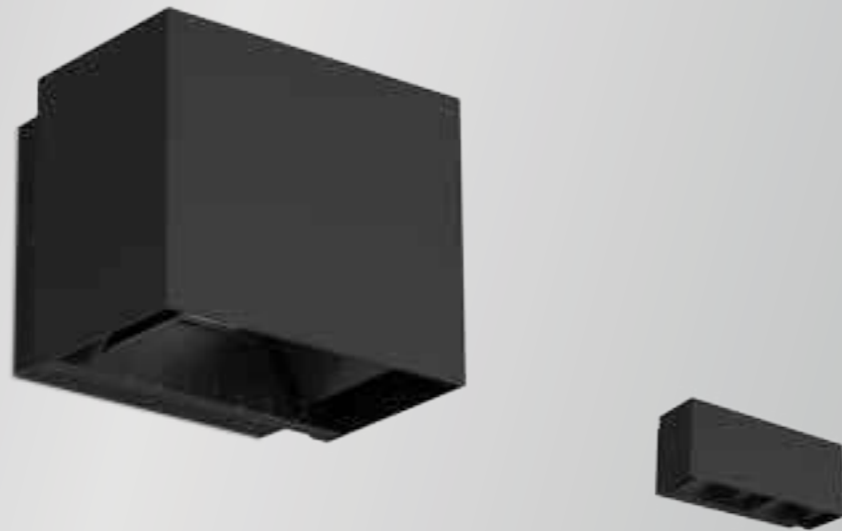

## JWL20 Wall light

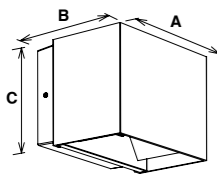



This Classical IP65 WALL light JWL20 with beam angle changeable directly from aluminum plate , which meets different demand from users and satisfy various lighting effects . The simple and decent design in up and down which reached excellent thermal management.

- ▶  15°~120°  
15°~120° IP65
- ▶ AC 200-240V PF≥0.9 CRI≥80
- ▶ SAA RoHS CE

Code	Watt	Size(AxBxCmm)	Lumen(±5%)	N.W/pc(kgs)	Q'ty/CTN
JWL20-10W	10W	120x96.8x100	900lm	0.59	18PCS
JWL20-18W	18W	242x97.7x100	1350lm	1.10	12PCS

CCT 3000K 4000K 5000K 5700K

Finish  White  Black

## JWL16 Wall light

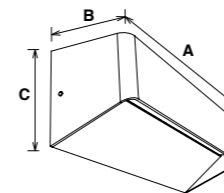

JWL16 IP54 WALL light adopts traditional design to satisfy public aesthetic view , the up and down design meet classic demand and distributes perfect lighting effects . IP54 and IK08 with fire-rated 94-V0 PC make your life more comfortable.

- ▶  100°  
100° IP54
- ▶ AC 220-240V PF≥0.9 CRI≥80
- ▶ SAA RoHS CE

Code	Watt	Size(AxBxCmm)	Lumen(±5%)	N.W/pc(kgs)	Q'ty/CTN
JWL16-1510-10W	10W	150x92x100	500lm	0.54	24PCS
JWL16-3010-18W	18W	300x92x100	900lm	1.05	12PCS

CCT 3000K 4000K 5000K 5700K Finish

 White  Black



## JWL06A Wall light

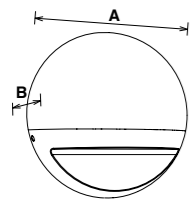

SMD led design JWL06A led wall light impresses with its unique design as well as the tactile appeal. Smiley-face design on the wall makes everyone feel warm and cozy, IP54 for indoor and outdoor use, die-casting aluminum ADC12 with very good heat dissipation and UL94-V0 fire rated milky PC material with even and soft light output.

- ▶ 120°
- ▶ AC 100-277V PF≥0.9 CRI≥80
- ▶ SAA RoHS CE

Code	Watt	Size(AxBmm)	Lumen(±5%)	N.W/pc(kgs)	Q'ty/CTN
JWL06A-12W	12W	159x65.5	1050lm	0.35	36PCS

CCT 
3000K
4000K
5000K
5700K

Finish 
 White
  Black

## JWL06B Wall light

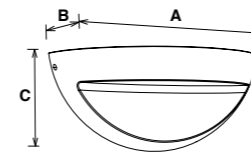

COB led design JWL06A led wall light impresses with its unique design as well as the tactile appeal. Smiley-face design on the wall makes everyone feel warm and cozy, IP54 for indoor and outdoor use, die-casting aluminum ADC12 with very good heat dissipation and UL94-V0 fire rated milky PC material with even and soft light output.

- ▶ 60°
- ▶ AC 100-277V PF≥0.9 CRI≥80
- ▶ SAA RoHS CE

Code	Watt	Size(AxBxCmm)	Lumen(±5%)	N.W/pc(kgs)	Q'ty/CTN
JWL06B-12W	12W	158x70x66.5	1100lm	0.30	36PCS

CCT 
3000K
4000K
5000K
5700K

Finish 
 White
  Black

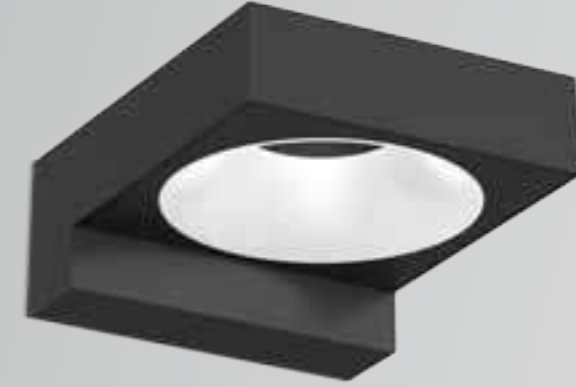

## JWL07 Wall light

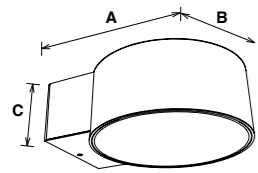

JWL07B LED wall light provides a stylish architectural luminaire for interior applications by the unique form and up light and down light functional design. JWL07B adopts aluminum housing which provides excellent thermal management and 94-V0 fire rated PC which distributes softly lighting to creating comfortable atmosphere.

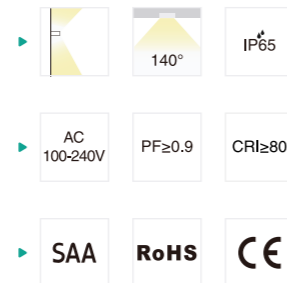

Code	Watt	Size(AxBxCmm)	Lumen(±5%)	N.W/pc(kgs)	Q'ty/CTN
JWL07-8W	8W	170x140x59	655lm	0.50	24PCS

CCT — 3000K 4000K 5000K 5700K

Finish — White Black

## JWL08 Wall light

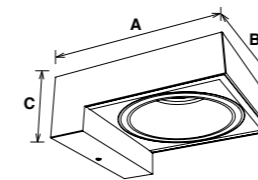

JWL08 LED Wall light is up and down design with internal driver, adopts aluminum housing provides excellent thermal dissipation, the 94-V0 fire rated PC distributes soft and unique light, IP65 suitable for both indoor and outdoor use.

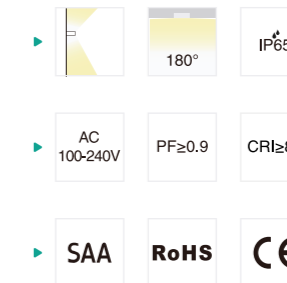

Code	Watt	Size(AxBxCmm)	Lumen(±5%)	N.W/pc(kgs)	Q'ty/CTN
JWL08-8W	8W	139x115x52	670lm	0.42	24PCS

CCT — 3000K 4000K 5000K 5700K

Finish — White Black



## JWL59 Wall light

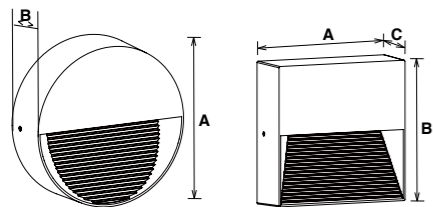

JWL59 is an IP65 surface mounted wall light, the shell is made of high-strength aluminum alloy and making the protection level reach IK08 and UV resistant, the appearance of this series product is designed in a minimalist style. Simple square and circular lines combined with indirection LED light source can create a beautiful and soft lighting environment. The wall light can be used both in indoor and outdoor installation environments.

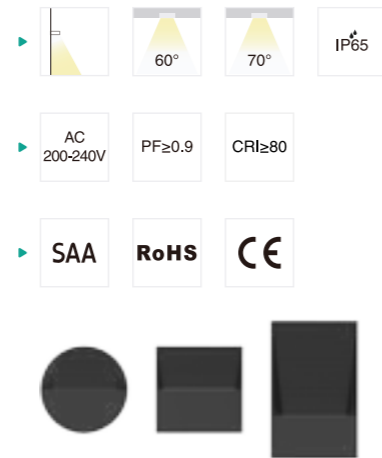

Code	Watt	Size(AxBxCmm)	Lumen(±5%)	N.W/pc(kgs)	Q'ty/CTN
JWL59A-5W	5W	Ø114x40	220lm	0.33	36PCS
JWL59A-8W	8W	Ø180x37	500lm	0.62	24PCS
JWL59B-5W	5W	114x114x40	220lm	0.39	36PCS
JWL59B-8W	8W	180x180x40	400lm	0.74	24PCS
JWL59C-5W	5W	114x180x35	220lm	0.53	12PCS
JWL59C-10W	10W	114x250x35	220lm	0.75	12PCS

CCT 3000K 4000K 5000K 5700K

Finish White Black



## JWL60

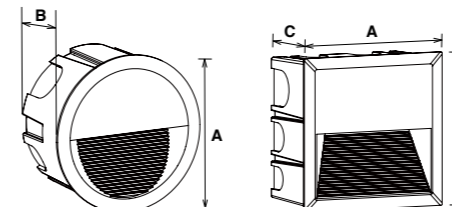

JWL60 is an IP65 recessed wall light, the shell is made of high-strength aluminum alloy and making the protection level reach IK08 and UV resistant, the appearance of this series product is designed in a minimalist style. Simple square and circular lines combined with indirection LED light source can create a beautiful and soft lighting environment. The wall light can be used both in indoor and outdoor installation environments.

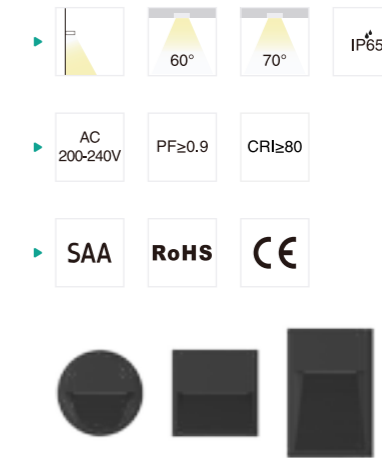

Code	Watt	Size(AxBxCmm)	Cut-out(mm)	Lumen(±5%)	N.W/pc(kgs)	Q'ty/CTN
JWL60A-5W	5W	Ø135x78	Ø130X78	220lm	0.38	18PCS
JWL60A-8W	8W	Ø202x78	Ø196X78	400lm	0.71	6PCS
JWL60B-5W	5W	136x136x78	130X130X78	220lm	0.45	18PCS
JWL60B-8W	8W	201x201x78	195X195X78	400lm	0.85	6PCS
JWL60C-5W	5W	136x202x78	130X196X78	220lm	0.61	12PCS
JWL60C-10W	10W	271x135x78	130X266X78	500lm	0.86	12PCS

CCT 3000K 4000K 5000K 5700K

Finish White Black



## JWL02 Step light

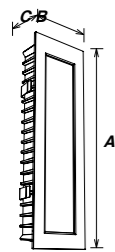

JWL02 slim step light is with internal driver design, adopts aluminum housing provides excellent thermal dissipation, the reflector and tempered glass distributes uniform light which creates comfortable visual experience, IP54 suitable for indoor and semi-outdoor use.

- ▶ 60°
- ▶ IP54
- ▶ AC 100-240V
- ▶ PF≥0.5
- ▶ CRI≥80
- ▶ SAA
- ▶ RoHS
- ▶ CE



Code	Watt	Size(AxBxCmm)	Cut-out(mm)	Lumen(±5%)	N.W/pc(kgs)	Q'ty/CTN
JWL02-7070-3W	3W	70x70x24	60x60	220lm	0.22	50PCS
JWL02-11070-3W	3W	110x70x27	100x60	220lm	0.30	40PCS
JWL02-20070-3W	3W	200x70x32	190x60	220lm	0.45	24PCS
JWL02-200135-8W	8W	200x135x32	190x125	580lm	0.66	24PCS

CCT — 3000K — 4000K — 5000K — 5700K

Finish — White



## JWL62 Wall light

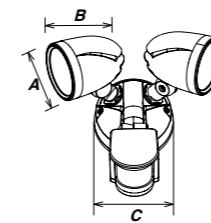

JWL62 is an IP44 wall light with PIR sensor, it adopts high lumen COB light source and ADC12 aluminum. The lamp has a high lumen efficiency and great heat dissipation. Wall mounted and ceiling mounted options. It's a great choice for outdoor walkways, garage areas, back door entrances etc.

- ▶ 90°
- ▶ IP44
- ▶ PIR Sensor
- ▶ AC 200-240V
- ▶ PF≥0.5
- ▶ CRI≥80
- ▶ RoHS
- ▶ CE

Code	Watt	Size(AxBxCmm)	Lumen(±5%)	N.W/pc(kgs)	Q'ty/CTN
JWL62-11W	11W	Ø76x96xØ121	1250lm	0.48	24PCS
JWL62-12W-S	12W	Ø76x96xØ121	1250lm	0.58	24PCS
JWL62-23W	23W	Ø76x96xØ121	2350lm	0.75	12PCS
JWL62-24W-S	24W	Ø76x96xØ121	2350lm	0.85	12PCS

CCT — 2700K — 3000K — 4000K — 5000K

Finish — White Black



# JWL01 Wall light

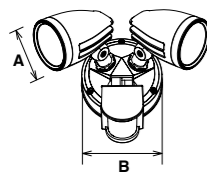

JWL01 is a traditional Wall light with internal driver, the lighting direction can be adjusted accordingly, single head and multi-heads are both available. Sensor function optional, IP65( IP54 for sensor function) suitable for a variety applications.

- ▶ 90°
- ▶ IP65 IP54
- ▶ PIR Sensor
- ▶ AC 100-240V PF≥0.8 CRI≥80
- ▶ SAA RoHS CE TÜV certified

Code	Watt	Size(AxBmm)	Lumen(±5%)	N.W/pc(kgs)	Q'ty/CTN
JWL01-8W	8W	Ø76xØ133	760lm	0.70	12PCS
JWL01-13W	13W	Ø76xØ133	1145lm	0.58	12PCS
JWL01-16W	16W	Ø76xØ133	1520lm	0.94	12PCS
JWL01-26W	26W	Ø76xØ133	2240lm	0.94	12PCS

CCT — 3000K 4000K 5000K 5700K

Finish — Black



# JWL11 Wall light

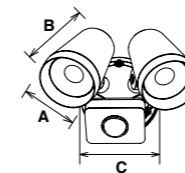

IP65 JWL11 LED Wall light is available for PIR sensor adjusting the lux and duration time, a great choice for outdoor walkways, garage areas, and back door entrances etc. It allows one head & two heads; the ADC12 heat sink makes the excellent heat dissipation; internal isolated driver ensures the safety and saves the space. Both wall mounted and ceiling mounted are optional, easy to install.

- ▶ 36° 60°
- ▶ IP65
- ▶ PIR Sensor
- ▶ AC 220-240V PF≥0.9 CRI≥80
- ▶ RoHS CE

Code	Watt	Size(AxBxCmm)	Lumen(±5%)	N.W/pc(kgs)	Q'ty/CTN
JWL11-8W	8W	Ø60.5x87xØ100	800lm	0.45	18PCS
JWL11-16W	16W	Ø60.5x87xØ100	1600lm	0.72	18PCS

CCT — 3000K 4000K 5000K 5700K

Finish — Black



## JML06 Spike light

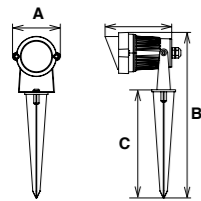

JML06 LED Spike light adopts aluminum body and plastic spike for damp conditions. The AC/DC12V input provides more safety guarantee. IP65 for outdoor use, it applies to landscaping embellishment lighting for residence and community and all kind of parks.

- ▶ 60°
- ▶ IP65
- ▶ AC/DC 12V
- ▶ PF≥1.0
- ▶ CRI≥80
- ▶ SAA
- ▶ RoHS
- ▶ CE

Code	Watt	Size(AxBxCmm)	Lumen(±5%)	N.W/pc(kgs)	Q'ty/CTN
JML06-6W	6W	Ø72x243x97	360lm	0.24	50PCS

CCT — 3000K — 4000K — 5000K — 5700K

Finish — Black



## JML07 Spike light

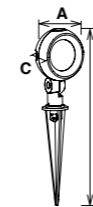

JML07 LED Spike light adopts integrated SMD light source of fashion design, equipped with high lumen, high CRI, low temperature and long lifespan. Built-in driver, the AC/DC12V input provides more safety guarantee. IP65 for outdoor use, it applies to landscaping embellishment lighting for residence and community and all kind of parks.

- ▶ 36°
- ▶ 60°
- ▶ IP65
- ▶ AC/DC 12V
- ▶ PF≥1.0
- ▶ CRI≥80
- ▶ SAA
- ▶ RoHS
- ▶ CE

Code	Watt	Size(AxBxCmm)	Lumen(±5%)	N.W/pc(kgs)	Q'ty/CTN
JML07-6W	6W	Ø76x262x57.5	550lm	0.31	50PCS
JML07-10W	10W	Ø76x262x57.5	950lm	0.31	50PCS

CCT — 3000K — 4000K — 5000K — 5700K

Finish — Black



Asymmetric light distribution

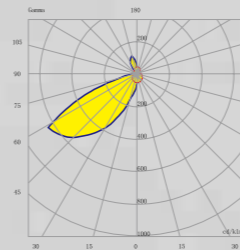

# JNL08 Garden light

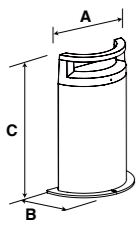

JNL08 LED garden light wins 2020 IF Award, adopting high lumen SMD, aluminum body with great thermal management. It is IP65 IK08 high protection. Indirect lighting design offers a great visual experience. Special shape design provides charming light spot. Size 500mm and 1000mm for options.

- ▶ 50° IP65
- ▶ AC 200-240V PF ≥ 0.9 CRI ≥ 80
- ▶ RoHS CE

Code	Watt	Size(AxBxCmm)	Lumen(±5%)	N.W/pc(kgs)	Q'ty/CTN
JNL08A-10W	10W	249x121x500	530lm	2.34	6PCS
JNL08B-10W	10W	249x121x1000	530lm	4.03	2PCS

CCT ——— 3000K 4000K 5000K 5700K

Finish ——— Black

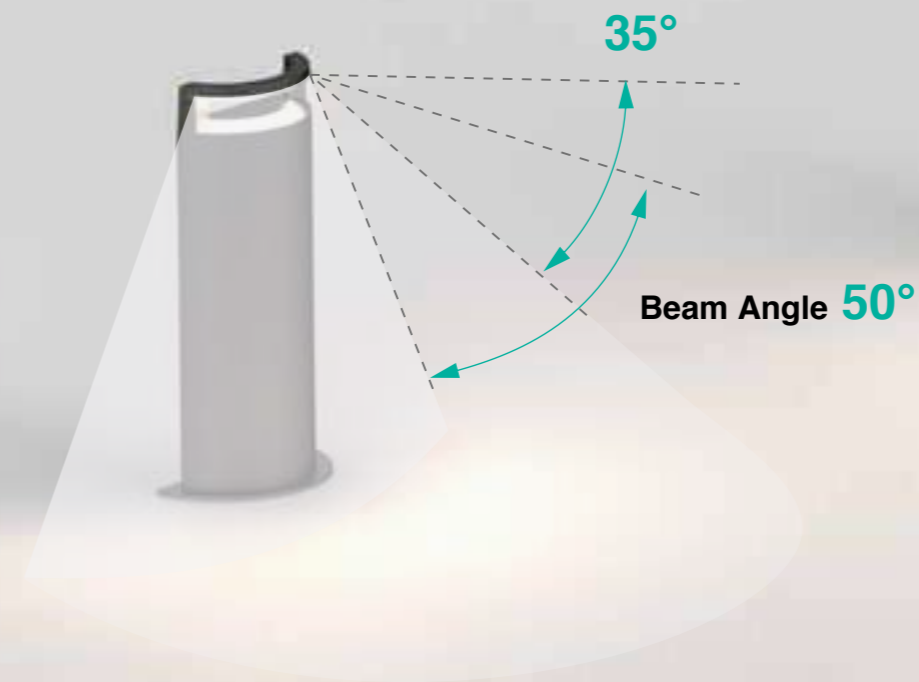





# JML08 Garden light

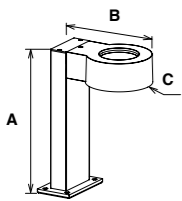

JML08 LED garden light is a stylish architectural luminaire with double-sided light design. Aluminum material provides excellent thermal management. IP65 waterproof is suitable for outside garden. The holder length is optional among 300mm, 500mm, 700mm, and 1000mm.

- ▶ 120°
- ▶ AC 100-240V PF≥0.9 CRI≥80
- ▶ RoHS CE

Code	Watt	Size(AxBxHmm)	Lumen(±5%)	N.W/pc(kgs)	Q'ty/CTN
JML08-300-8W	8W	300x208xØ140	655lm	1.30	6PCS
JML08-500-8W	8W	500x208xØ140	655lm	1.72	6PCS
JML08-700-8W	8W	700x208xØ140	655lm	2.15	6PCS
JML08-1000-8W	8W	1000x208xØ140	655lm	2.62	6PCS

CCT — 3000K 4000K 5000K 5700K

Finish — Black



LED Wall & Spike light



## JML18 Mirror light

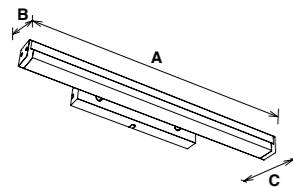

JML18 is a super design mirror light, it adopts high transmittance PC lampshade and AL6063 aluminum lamp body. High lumen SMD LED with 110lm/W light effect, be available of interchangeable CCT by slide switch. It's elegant design, perfect details to create a sense of stylish. Widely be used in Hotel, Shopping mall, home, restaurant, etc.

- ▶ 120° IP40
- ▶ SLIDE SWITCH
- ▶ AC 100-240V PF≥0.9 CRI≥80
- ▶ SAA RoHS CE

Code	Watt	Size(AxBxCmm)	Lumen(±5%)	N.W/pc(kgs)	Q'ty/CTN
JML18-580-10W	10W	580x50x111	1180lm	0.74	12PCS
JML18-860-15W	15W	860x50x111	1950lm	0.96	12PCS
JML18-1140-20W	20W	1140x50x111	2430lm	1.18	12PCS

CCT — 3000K 4000K 5000K 5700K

Finish — White Black



## JML01 Mirror light

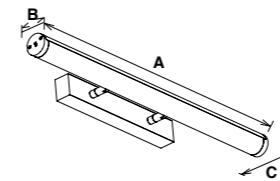

JML01 mirror light with concise and elegant design, adopting high transmittance PC lampshade, AL6063 aluminum lamp body, high lumen SMD LED with 110lm/W. Interchangeable CCT by slide switch is available, Brush Nickel/Chrome plated/Matt Black multiple finish color for option.

- ▶ 120° IP40
- ▶ SLIDE SWITCH
- ▶ AC 100-240V PF≥0.9 CRI≥80
- ▶ SAA RoHS CE

Code	Watt	Size(AxBxCmm)	Lumen(±5%)	N.W/pc(kgs)	Q'ty/CTN
JML01-580-10W	10W	580x41x111	1180lm	0.66	12PCS
JML01-860-15W	15W	860x41x111	1845lm	0.87	12PCS
JML01-1140-20W	20W	1140x41x111	2300lm	1.03	12PCS

CCT — 3000K 4000K 5000K 5700K

Finish — White Black Silver Nickel Brushed



# JML15 Mirror light

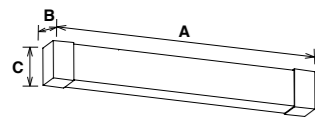

JML15 Mirror lamp has a wide beam angle, it adopts 2835 SMD high lumen light source to reach high efficiency, 120lm/W for standard version, 110lm/W for sensor version. PC diffuser provides a uniform light output. The whole lamp is IP44 IK06 protection level, dismountable design makes a more convenient installation. Interchangeable CCT (3000/4000/5700k) with slide switch and microwave sensor option can also make users has a great experience.

- ▶ 140°
- ▶ IP44
- ▶ ((··))
- ▶ AC 200-240V
- ▶ PF ≥ 0.9
- ▶ CRI ≥ 80
- ▶ RoHS
- ▶ CE

Code	Watt	Size(AxBxCmm)	Lumen(±5%)
JML15-450-8W	8W	450x58x85	880lm
JML15-600-10W	10W	600x58x85	1200lm

CCT — 3000K — 4000K — 5700K

Finish — White Black

# JML13 Mirror light

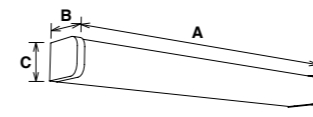

JML13 mirror light is an easy dismountable design, adopting high transmittance PC lampshade and high lumen SMD LED with 120lm/W, flicker free internal driver. Full PC material makes a lighter weight. Interchangeable CCT by slide switch and sensor function for 600mm/900mm is available, replaceable end cap with white, black or silver color options.

- ▶ 120°
- ▶ IP44
- ▶ ((··))
- ▶ AC 200-240V
- ▶ PF ≥ 0.9
- ▶ CRI ≥ 80
- ▶ RoHS
- ▶ CE

Code	Watt	Size(AxBxCmm)	Lumen(±5%)
JML13-480-8W	8W	480x77.5x61	960lm
JML13-600-12W	12W	600x77.5x61	1440lm
JML13-900-15W	15W	900x77.5x61	1800lm

CCT — 3000K — 4000K — 5000K — 5700K

Finish — White Black



# LED Tube Light

/Series/

LED tube light more energy saving and high brightness are the first goal we are pursuing of all the time. Generous, simple and practical are what we have been working for. Brand Chip, CRI>80/ 90, high brightness more than 85LM/W, PC cover, Aluminum holder, EMI, EMC passed driver, high light transmittance are the main reason we win our reputation.



# JT8-AL+PC Tube light

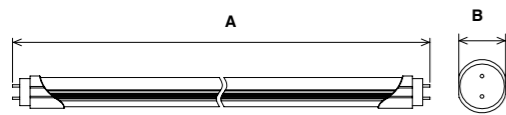

Jibe Lighting JT8-AL+PC LED Tube light adopts SMD LED with high brightness and slight light decay and V0 fire-rated PC cover, up to 95% light transmittance. Reliable LED driver with branded high quality capacitor and IC solution ensures excellent working performance.

- ▶ 120° IP20
- ▶ AC 100-265V AC 100-240V PF ≥ 0.9 CRI ≥ 80
- ▶ SAA RoHS CE

Code	Watt	Size(AxBmm)	Lumen(±5%)	N.W/pc(kgs)	Q'ty/CTN
JT8-600-10W	10W	603xØ29.3	120lm/W	0.18	25PCS
JT8-1200-18W	18W	1211xØ29.3	120lm/W	0.31	25PCS
JT8-1500-25W	25W	1514xØ29.3	120lm/W	0.38	25PCS
JT8-600-6W	6W	603xØ29.3	150lm/W	0.18	25PCS
JT8-1200-12W	12W	1211xØ29.3	150lm/W	0.31	25PCS
JT8-1500-15W	15W	1514xØ29.3	150lm/W	0.38	25PCS
JT8-600-9W	9W	603xØ28.5	140lm/W	0.18	25PCS
JT8-900-10W	10W	907xØ28.5	140lm/W	0.21	24PCS
JT8-1200-18W	18W	1211xØ28.5	140lm/W	0.31	25PCS
JT8-1500-23W	23W	1514xØ28.5	140lm/W	0.38	25PCS
JT8-600-8W	8W	603xØ28.5	160lm/W	0.18	25PCS
JT8-900-9W	9W	907xØ28.5	160lm/W	0.21	24PCS
JT8-1200-16W	16W	1211xØ28.5	160lm/W	0.31	25PCS
JT8-1500-22W	22W	1514xØ28.5	160lm/W	0.38	25PCS
JT8-600-7W	7W	603xØ28.5	180lm/W	0.18	25PCS
JT8-900-8W	8W	907xØ28.5	180lm/W	0.21	24PCS
JT8-1200-14W	14W	1211xØ28.5	180lm/W	0.31	25PCS
JT8-1500-18W	18W	1514xØ28.5	180lm/W	0.38	25PCS

CCT — 3000K 4000K 5000K 5700K

Cover — Clear Frosted





# JT8 PC Tube light



Jibe Lighting's practical tube JT8 adopts complete PC cover, using 2835SMD LED as light source, CRI>80. V0 fire-rated full PC cover ensures high light transmittance and safe installation. No yellowing and cracking.

- ▶ 120° IP20
- ▶ AC 100-240V PF ≥ 0.9 CRI ≥ 80
- ▶ SAA RoHS CE

Code	Watt	Size(AxBmm)	Lumen(±5%)	N.W/pc(kgs)	Q'ty/CTN
JT8-600-10W-PC	10W	603xØ26	1240lm	0.14	25PCS
JT8-1200-18W-PC	18W	1213xØ26	1830lm	0.26	25PCS
JT8-1500-20W-PC	20W	1513xØ26	2640lm	0.38	25PCS

CCT — 3000K — 4000K — 5000K — 5700K

Cover — Frosted

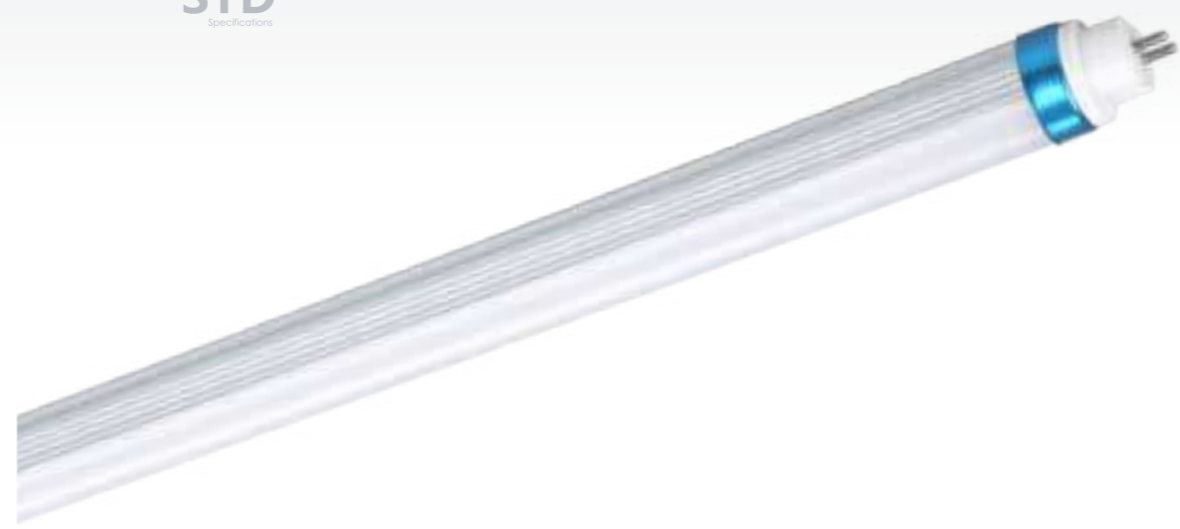

# JT6 Tube light

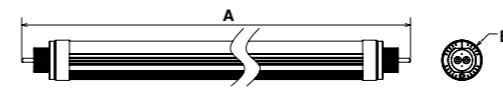

JT6 adopts complete PC cover, using 2835SMD LED as light source, CRI>80. V0 fire-rated full PC cover ensures high light transmittance and safe installation. No yellowing and cracking.

- ▶ 120° IP20
- ▶ AC 100-240V PF ≥ 0.9 CRI ≥ 80
- ▶ SAA RoHS CE

Code	Watt	Size(AxBmm)	Lumen(±5%)	N.W/pc(kgs)	Q'ty/CTN
TJ6-1200-15W-A	15W	1213xØ23.3	2000lm	0.22	25PCS

CCT — 3000K — 4000K — 5000K — 5700K

Cover — Frosted



## JT5-E Tube light

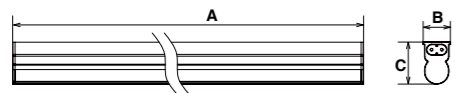

Complete PC LED tube JT5 is a successful low-cost design; V0 fire-rated PC housing provides safe and portable installation. Independent switch makes it more convenient and flexible in use.

- ▶ 120° IP20
- ▶ AC 100-277V PF≥0.9 CRI≥80
- ▶

Code	Watt	Size(AxBxCmm)	Lumen(±5%)	N.W/pc(kgs)	Q'ty/CTN
JT55W300-E	5W	278x22.5x37	500lm	0.07	50PCS
JT58W600-E	8W	578x22.5x37	880lm	0.10	50PCS
JT512W900-E	12W	878x22.5x37	1320lm	0.13	30PCS
JT518W1200-E	18W	1178x22.5x37	1980lm	0.17	30PCS
JT525W1500-E	25W	1478x22.5x37	2750lm	0.21	30PCS

CCT — 3000K 4000K 5000K 5700K

Cover — Frosted



## JT5-S Tube light

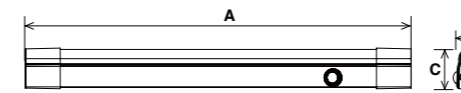

Integrated complete PC LED tube JT5-S is a successful economic design. Adopt high lumen SMD LED as light source, full PC cover (pass 750C° glow-wire test) ensures high light transmittance and safe installation. Changeable CCT and IP42 protection level also make it easier maintenance. Special installation: Surface mounted and wall mounted with different accessories. Linkable design with connect wires or connect accessories, which is suitable for a wider application.

- ▶ 160° IP42
- ▶ AC 200-240V PF≥0.9 CRI≥80
- ▶

Code	Watt	Size(AxBxCmm)	Lumen(±5%)	N.W/pc(kgs)	Q'ty/CTN
JT55W355-S	5W	355x22.3x37.4	535m	0.18	50PCS
JT58W600-S	8W	600x22.3x37.4	980lm	0.25	50PCS
JT518W1200-S	18W	1200x22.3x37.4	2205lm	0.37	30PCS
JT525W1500-S	25W	1500x22.3x37.4	3045lm	0.43	30PCS

CCT — 3000K 4000K 5000K 5700K

Cover — Frosted



# LED Spot Light

/Series/

LED spotlights are typical modern lighting without main lights and fixed scale, which can create perfect atmosphere. Jibe Lighting spotlight series has good quality, soft and elegant lighting output, which can also be used for local lighting. Commonly used GU10 and MR16 base, various types to meet the different needs from customers.





**JSP91/92** Spot Light



**JSP77** Spot Light



**JSP43** Spot Light



**JSP51** Spot Light



**JSP48** Spot Light



**JSP57** Spot Light



**JV25** Spot Light