

JIBE LIGHTING — HEADQUARTERS  
Hogebrinkerweg 14V - 3871 KN Hoevelaken  
Netherlands Tel: +31 (0)33 844 7111  
info@jibe.lighting - www.jibe.lighting



جيب!ز

LED THERE BE LIGHT

JIBE LIGHTING — GERMANY  
Marie-Curie-Ring 38- 63477 Maintal  
Germany Tel: +49 (0)6181 90 90 509  
Mob : +49 (0)162 26 36 614  
fax : +49 (0)6181 61 01 618  
s.fischer@jibe-lighting.de

JIBE LIGHTING — NORTH AMERICA  
5917 NW 63 Way - Parkland FL 33067  
USA Tel: 954-899-4040  
todd.darling@jibeusa.lighting

© 2020 Jibe Lighting - all rights reserved

Jibe reserves the right to alter material, dimensions and characteristics without prior notice.  
Read installation instructions carefully. Technical information on the installation instruction  
has precedence over the information in the brochure.  
Our general terms and conditions shall apply notwithstanding any stipulation to the contrary  
to all the orders and agreements with Jibe.  
You can obtain a copy of these conditions on demand.  
For latest information and specifications of the full product range  
visit [www.jibe.lighting](http://www.jibe.lighting)

LED  
DOWNLIGHT  
SERIES

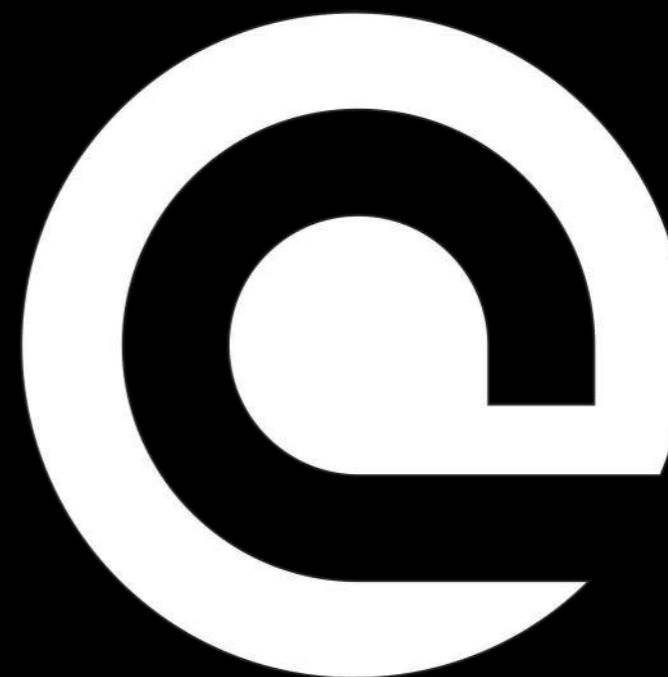

جيب!ز



# LED Downlight /Series/

LED downlight series provide turn-key lighting solutions in domestic and commercial applications. Our downlight is a combination of technique and emotion. We offer our customers a platform to experience the good quality and lighting effects with unique design, 100lm/w and more, UGR<19, Ra80 and Ra90, smart function. The Jibe lighting downlight family provides different solutions for project and distribution with different product types: COB/SMD version, IP54/IP44/IP20, recessed/surface mounted/pendant, different sizes, different watts. The export volume of Jibe lighting downlight is in the top three for three consecutive years according to China export data. Jibe Lighting is your one-stop service supplier for any downlight you're looking for!



# JDL210 Downlight

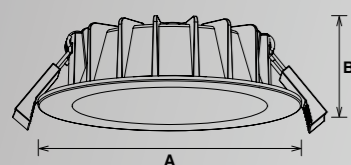

JDL210 LED downlight is with super slim design, external driver, adopting high lumen SMD LED, PC diffuser with uniform light. ADC12 Aluminum profile provides excellent thermal dissipation. Interchangeable CCT with slide switch is available. IP54 waterproof for front side.

- ▶ 90° IP54
- ▶ DIM DALI 0-10V SLIDE SWITCH 3 in 1 Smart Lighting
- ▶ AC 200-240V PF≥0.9 CRI≥80
- ▶ RoHS CE



Code	Watt	Size(AxBmm)	Cut-out(mm)	Lumen(±5%)	N.W/pc(kgs)	Q'ty/CTN
JDL210-3-10W	10W	Ø110x30	Ø90-95	960lm	0.25	36PCS
JDL210-3-13W	13W	Ø110x30	Ø90-95	1150lm	0.25	36PCS
JDL210-4-13W	13W	Ø145x30	Ø120-130	1270lm	0.35	30PCS
JDL210-4-18W	18W	Ø145x30	Ø120-130	1980lm	0.35	30PCS
JDL210-6-18W	18W	Ø190x30	Ø160-170	1930lm	0.50	24PCS
JDL210-6-25W	25W	Ø190x30	Ø160-170	2750lm	0.50	24PCS
JDL210-8-25W	25W	Ø225x34	Ø200-210	2630lm	0.65	12PCS
JDL210-8-35W	35W	Ø225x34	Ø200-210	3570lm	0.65	12PCS
JDL210-8-42W	42W	Ø225x34	Ø200-210	4750lm	0.65	12PCS

CCT — 3000K 4000K 5000K 5700K

Trim — White Black



# JDL216 Downlight

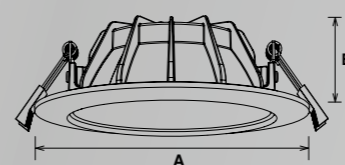

JDL216 LED downlight is with high lumen SMD LED, die casting aluminum ADC12, PC lamp cover, external driver. Deep trim design provides soft lighting for eyes. 3CCT changeable with slide switch is available. IP44 waterproof for front side.

- ▶ 90° IP44
- ▶ DIM DALI 0-10V SLIDE SWITCH 3 in 1
- ▶ AC 200-240V PF≥0.9 CRI≥80
- ▶ SAA RoHS CE



Code	Watt	Size(AxBmm)	Cut-out(mm)	Lumen(±5%)	N.W/pc(kgs)	Q'ty/CTN
JDL216-3-8W	8W	Ø114x45	Ø90-105	790lm	0.20	36PCS
JDL216-3.5-10W	10W	Ø129x45	Ø105-115	1045lm	0.30	36PCS
JDL216-4-13W	13W	Ø152x48	Ø125-140	1355lm	0.45	24PCS
JDL216-5-20W	20W	Ø175x52	Ø145-160	2090lm	0.56	12PCS
JDL216-7-25W	25W	Ø203x56	Ø175-190	2610lm	0.65	12PCS
JDL216-8-33W	33W	Ø228x63	Ø205-215	3445lm	0.76	6PCS

CCT — 3000K 4000K 5000K 5700K

Trim — White Black



# JDL97 Downlight

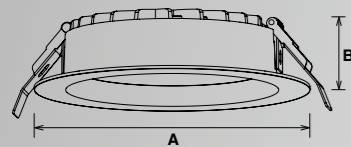

JDL97 LED downlight is with high lumen SMD LED, die casting aluminum ADC12, external driver, IP54 IK06 protection level. CCT changeable by slide switch is available. Full size from 2.5 inch to 8 inch are all available.

- 90°
- IP54
- DIM
- DALI
- 0-10V
- TUNABLE WHITE
- SLIDE SWITCH 3 IN 1
- 2.4G
- WIFI
- Bluetooth
- Smart Lighting
- AC 100-240V
- AC 200-240V
- PF≥0.9
- CRI≥80
- SAA
- RoHS
- CE
- CB



Code	Watt	Size(AxBmm)	Cut-out(mm)	Lumen(±5%)	N.W/pc(kgs)	Q'ty/CTN
JDL97-2.5-7W	7W	Ø85x39	Ø70-75	590lm	0.20	50PCS
JDL97-3-10W	10W	Ø100x38	Ø90-95	980lm	0.25	36PCS
JDL97-3-13W	13W	Ø100x38	Ø90-95	1300lm	0.25	36PCS
JDL97-3.5-13W	13W	Ø120x45	Ø100-110	1230lm	0.31	30PCS
JDL97-4-15W	15W	Ø145x45	Ø120-130	1600lm	0.46	30PCS
JDL97-5-18W	18W	Ø170x45	Ø140-150	2070lm	0.52	30PCS
JDL97-6-18W	18W	Ø190x45	Ø160-170	1900lm	0.66	20PCS
JDL97-6-25W	25W	Ø190x45	Ø160-170	2680lm	0.66	20PCS
JDL97-6-35W	35W	Ø190x45	Ø160-170	3900lm	0.66	20PCS
JDL97-8-18W	18W	Ø228x45	Ø200-210	2050lm	0.81	10PCS
JDL97-8-25W	25W	Ø228x45	Ø200-210	2650lm	0.81	10PCS
JDL97-8-35W	35W	Ø228x45	Ø200-210	4025lm	0.81	10PCS

CCT — 3000K 4000K 5000K 5700K

Trim — White Black



# JCL59 Downlight

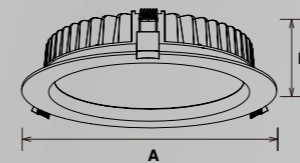

JCL59 LED downlight is with high lumen SMD LED, die casting aluminum ADC12, external driver, IP20 or IP44 available. CCT changeable by slide switch is available. Full size from 2 inch to 10 inch are all available.

- 90°
- IP44
- IP20
- DIM
- DALI
- 0-10V
- TUNABLE WHITE
- SLIDE SWITCH 3 IN 1
- DIM TO WARM
- 2.4G
- WIFI
- Bluetooth
- Smart Lighting
- AC 100-240V
- AC 200-240V
- PF≥0.9
- CRI≥80
- SAA
- RoHS
- CE



Code	Watt	Size(AxBmm)	Cut-out(mm)	Lumen(±5%)	N.W/pc(kgs)	Q'ty/CTN
JCL59-2-7W	7W	Ø80x39	Ø60-70	480lm	0.28	50PCS
JCL59-2.5-10W	10W	Ø85x39.5	Ø70-75	730lm	0.24	50PCS
JCL59-3-10W/-F	10W	Ø100x38	Ø90-100	720lm	0.28	24PCS
JCL59-3-12W/-F	12W	Ø110x38	Ø90-100	1170lm	0.28	24PCS
JCL59-3-13W/-F	13W	Ø110x38	Ø90-100	950lm	0.28	24PCS
JCL59-3.5-13W	13W	Ø120x39	Ø100-110	1150lm	0.45	24PCS
JCL59-4-13W	13W	Ø145x45	Ø120-130	950lm	0.59	30PCS
JCL59-4-18W	18W	Ø145x45	Ø120-130	1450lm	0.59	30PCS
JCL59-5-18W	18W	Ø170x45	Ø140-150	1550lm	0.70	30PCS
JCL59-5-25W	25W	Ø170x45	Ø140-150	2100lm	0.70	30PCS
JCL59-6-18W	18W	Ø190x45	Ø160-170	1560lm	0.83	20PCS
JCL59-6-25W	25W	Ø190x45	Ø160-170	2130lm	0.83	20PCS
JCL59-6-35W	35W	Ø190x45	Ø160-170	2830lm	0.83	20PCS
JCL59-8-18W	18W	Ø228x45	Ø200-210	1540lm	0.94	10PCS
JCL59-8-25W	25W	Ø228x45	Ø200-210	2130lm	0.94	10PCS
JCL59-8-35W	35W	Ø228x45	Ø200-210	2790lm	0.94	10PCS
JCL59-10-45W	45W	Ø280x52	Ø230-260	4170lm	1.60	10PCS

CCT — 3000K 4000K 5000K 5700K

Trim — White Black Silver Chrome



# JDL04 Downlight

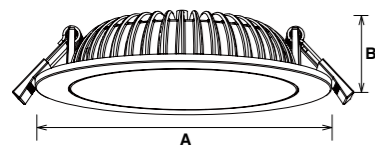

JDL04 LED downlight is with high lumen SMD LED, die casting aluminum ADC12 with good heat dissipation, external driver, Super slim design.

- ▶ 120° IP20
- ▶ DIM DALI 0-10V
- ▶ AC 100-240V AC 200-240V PF≥0.9 CRI≥80
- ▶ SAA RoHS CE



Code	Watt	Size(AxBmm)	Cut-out(mm)	Lumen(±5%)	N.W/pc(kgs)	Q'ty/CTN
JDL04-4-12W	12W	Ø145x31.5	Ø120-135	1170lm	0.38	30PCS
JDL04-6-18W	18W	Ø199x34.5	Ø170-190	1800lm	0.82	20PCS
JDL04-8-24W	24W	Ø245x34.5	Ø210-235	2500lm	0.92	20PCS

# JDL300 Downlight

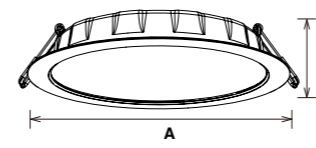

JDL300 downlight adopts high lumen SMD led, PS diffuser and steel housing, CCT switchable and Sensor function provide more choices to consumers.

- ▶ 120° IP20
- ▶ DIM SLED SWITCH 3 in 1 ((·))
- ▶ AC 200-240V PF≥0.9 CRI≥80
- ▶ RoHS CE

Code	Watt	Size(AxBmm)	Cut-out(mm)	Lumen(±5%)	N.W/pc(kgs)	Q'ty/CTN
JDL300-9W	9W	Ø120x40	Ø90-100	990lm	0.14	24PCS
JDL300-9W	9W	Ø130x40	Ø100-110	990lm	0.14	24PCS
JDL300-12W	12W	Ø150x40	Ø120-130	1320lm	0.18	24PCS
JDL300-15W	15W	Ø170x40	Ø140-150	1650lm	0.20	24PCS
JDL300-18W	18W	Ø190x40	Ø160-170	1980lm	0.27	12PCS
JDL300-20W	20W	Ø230x40	Ø200-210	2200lm	0.31	12PCS
JDL300-25W	25W	Ø280x40	Ø250-260	2750lm	0.14	12PCS





# JDL110 Downlight

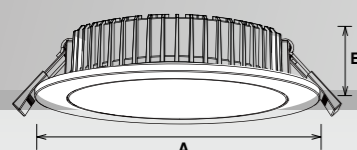

JDL110 LED downlight is with high lumen SMD LED, die casting aluminum ADC12, external driver. IP65 waterproof for indoor and outdoor use.

- ▶ 90°
- ▶
- ▶
- ▶



Code	Watt	Size(AxBmm)	Cut-out(mm)	Lumen(±5%)	N.W/pc(kgs)	Q'ty/CTN
JDL110-3-13W	13W	Ø115x55.5	Ø95-100	1320lm	0.40	24PCS
JDL110-4-18W	18W	Ø155x67	Ø120-130	1830lm	0.61	24PCS
JDL110-6-25W	25W	Ø195x46.5	Ø175-185	2550lm	0.75	12PCS
JDL110-8-35W	35W	Ø235x54.5	Ø205-215	3570lm	1.08	12PCS

CCT — 3000K 4000K 5000K 5700K

Trim — White Black Silver Chrome

# JDL161 Downlight

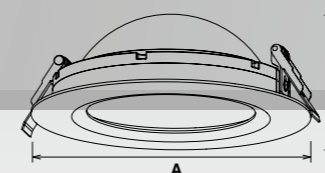

JDL161 LED downlight is with high lumen SMD LED, die casting aluminum ADC12, external driver. Special appearance and Indirect lighting design provides even and soft lighting.

- ▶ 120°
- ▶
- ▶
- ▶

Code	Watt	Size(AxBmm)	Cut-out(mm)	Lumen(±5%)	N.W/pc(kgs)	Q'ty/CTN
JDL161-6-10W	10W	Ø185x67	Ø160-170	700lm	0.42	12PCS
JDL161-8-20W	20W	Ø228x88.4	Ø200-210	1520lm	0.59	12PCS

CCT — 3000K 4000K 5000K 5700K

Trim — White



# JDL44 Downlight

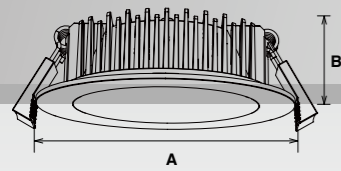

JDL44 LED downlight is with high lumen SMD LED, UL94-V0 Fire-rated PC diffuser, external driver. IP54 waterproof for indoor damp location. Integrated design of heatsink and frame provides more heat dissipation area.

- ▶ 90° IP54
- ▶ DIM DALI 0-10V SLIDE SWITCH 3 in 1
- ▶ AC 100-240V AC 200-240V PF≥0.9 CRI≥80
- ▶ SAA RoHS CE

Code	Watt	Size(AxBmm)	Cut-out(mm)	Lumen(±5%)	N.W/pc(kgs)	Q'ty/CTN
JDL44-3-10W	10W	Ø104x31	Ø90-95	790lm	0.26	24PCS
JDL44-3-13W	13W	Ø104x31	Ø90-95	1070lm	0.26	24PCS

CCT — 3000K 4000K 5000K 5700K

Trim — White Black Silver

# JCL22 Downlight

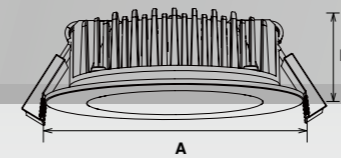

JCL22 LED downlight is with high lumen SMD LED, PMMA diffuser, external driver, IP20 or IP44 available. CCT changeable by slide switch is available.

- ▶ 90° IP44 IP20
- ▶ DIM DALI 0-10V DIM TO WARM
- ▶ SLIDE SWITCH 3 in 1 2.4G WIFI
- ▶ AC 100-240V PF≥0.9 CRI≥80
- ▶ SAA RoHS CE

Code	Watt	Size(AxBmm)	Cut-out(mm)	Lumen(±5%)	N.W/pc(kgs)	Q'ty/CTN
JCL22-2.5-7W	7W	Ø85x31	Ø70-75	480lm	0.35	50PCS
JCL22-2.5-10W	10W	Ø85x31	Ø70-75	740lm	0.35	50PCS
JCL22-3-10W	10W	Ø104x31	Ø90-95	900lm	0.38	24PCS
JCL22-3-13W	13W	Ø104x31	Ø90-95	1075lm	0.38	24PCS

CCT — 3000K 4000K 5000K 5700K

Trim — White Black Silver Chrome



# JDL147C Downlight

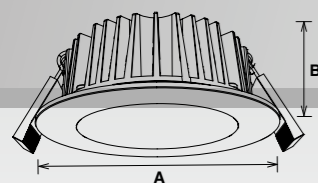

JDL147C LED downlight is with high lumen SMD LED, ADC7 lamp body and frame, PC lamp cover, external driver, IP20 IK06 protection. CCT changeable by slide switch. Round frame for options.

- ▶ 90° IP20
- ▶ DIM SLIDE SWITCH 3 in 1
- ▶ AC 220-240V PF≥0.9 CRI≥80
- ▶ SAA RoHS CE

Code	Watt	Size(AxBmm)	Cut-out(mm)	Lumen(±5%)	N.W/pc(kgs)	Q'ty/CTN
JDL147C-3-10W	10W	Ø103x38	Ø90-95	1000lm	0.32	24PCS

CCT — 3000K 4000K 5700K

Trim — White Black Silver Chrome

# JDL147F Downlight

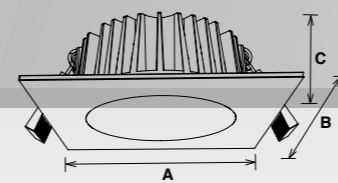

JDL147F LED downlight is with high lumen SMD LED, ADC7 lamp body and frame, PC lamp cover, external driver, IP20 IK06 protection. CCT changeable by slide switch. Square frame for options.

- ▶ 90° IP20
- ▶ DIM SLIDE SWITCH 3 in 1
- ▶ AC 220-240V PF≥0.9 CRI≥80
- ▶ SAA RoHS CE

Code	Watt	Size(AxBxCmm)	Cut-out(mm)	Lumen(±5%)	N.W/pc(kgs)	Q'ty/CTN
JDL147F-3-10W	10W	104x104x38	Ø90-95	1000lm	0.34	24PCS

CCT — 3000K 4000K 5700K

Trim — White Black Silver Chrome





## JDL141 Downlight

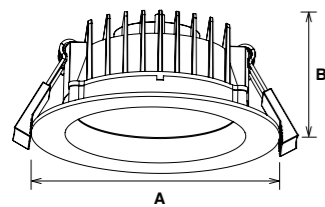

JDL141 LED downlight is with high lumen SMD LED, plastic coated aluminum lamp body, and PC frame, external driver, IP54 IK08 protection available. CCT changeable by slide switch.

- ▶ 90° IP54 IP20
- ▶ DIM SLIDE SWITCH 3 in 1 Smart Lighting
- ▶ AC 200-240V PF≥0.9 CRI≥80
- ▶ SAA RoHS CE

Code	Watt	Size(AxBmm)	Cut-out(mm)	Lumen(±5%)	N.W/pc(kgs)	Q'ty/CTN
JDL141-3-10W	10W	Ø110x39.5	Ø90-100	830lm	0.18	24PCS
JDL141B-3-10W	10W	Ø110x48	Ø90-100	950lm	0.21	24PCS

CCT — 3000K 4000K 5000K 5700K

Trim — White Black



## JDL150 Downlight

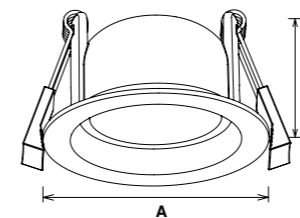

JDL150 LED downlight with SMD LED, external driver. IP44 waterproof. 3CCT switchable by slide switch. Vertical rotation 10° creates diversified lighting effects.

- ▶ 90° 10° IP44
- ▶ DIM SLIDE SWITCH 3 in 1
- ▶ AC 200-240V PF≥0.9 CRI≥80
- ▶ SAA RoHS CE

Code	Watt	Size(AxBmm)	Cut-out(mm)	Lumen(±5%)	N.W/pc(kgs)	Q'ty/CTN
JDL150-2.5-7W	7W	Ø85x50	Ø75-80	455lm	0.21	50PCS

CCT — 3000K 4000K 5000K 5700K

Trim — White



# JCL88 Downlight

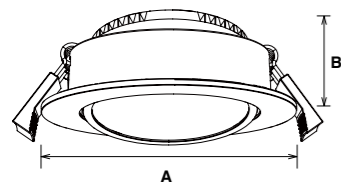

JCL88 LED downlight with SMD LED, ADC12 heat sink, external driver. Cutout size both 70mm and 90mm. Vertical rotation 25° creates diversified lighting effects.

- ▶ 90° 25° IP20
- ▶ DIM DALI 0-10V
- ▶ AC 100-240V AC 200-240V PF≥0.9 CRI≥80
- ▶ SAA RoHS CE

Code	Watt	Size(AxBmm)	Cut-out(mm)	Lumen(±5%)	N.W/pc(kgs)	Q'ty/CTN
JCL88-70-7W	7W	Ø85x28	Ø68	550lm	0.20	50PCS
JCL88-90-10W	10W	Ø104x30	Ø90	800lm	0.28	24PCS

CCT — 3000K 4000K 5000K 5700K

Trim — White Black

# JCL30 Downlight

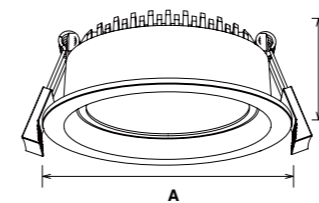

JCL30 LED downlight is with SMD LED, ADC12 heat sink, external driver. Lamp head adjustable provides different lighting direction. Standard and TUYA wireless intelligent solution are available.

- ▶ 90° 25° IP20
- ▶ DIM DALI 0-10V Smart Lighting
- ▶ AC 100-240V AC 200-240V PF≥0.9 CRI≥80
- ▶ SAA RoHS CE

Code	Watt	Size(AxBmm)	Cut-out(mm)	Lumen(±5%)	N.W/pc(kgs)	Q'ty/CTN
JCL30-13W	13W	Ø110x41.5	Ø95-100	900lm	0.40	24PCS

CCT — 3000K 4000K 5000K 5700K

Trim — White Black Silver Chrome



# JDL190 Downlight

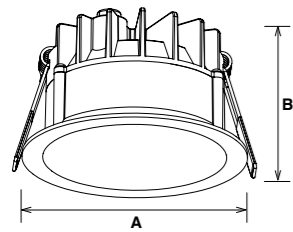

JDL190 LED downlight with high lumen SMD LED, PC-V2 lens, ACD12 lamp body, external driver. Deep trim design provides soft lighting.

- ▶ 60° IP44
- ▶ DIM
- ▶ AC 200-240V PF≥0.9 CRI≥80
- ▶ RoHS CE

Code	Watt	Size(AxBmm)	Cut-out(mm)	Lumen(±5%)	N.W/pc(kgs)	Q'ty/CTN
JDL190-3-10W	10W	Ø100x60	Ø88-93	1040lm	0.22	60PCS

CCT — 3000K 4000K 5000K 5700K

Trim — White Black



# JDL34 Downlight

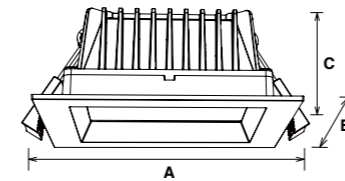

JDL34 LED downlight with high lumen SMD LED, square shape, ADC12 aluminum heat sink, external driver. IP20/IP44 waterproof available.

- ▶ 90° IP44 IP20
- ▶ DIM DALI 0-10V SLIDE SWITCH 3 in 1
- ▶ AC 100-240V AC 200-240V PF≥0.9 CRI≥80
- ▶ SAA RoHS CE

Code	Watt	Size(AxBxCmm)	Cut-out(mm)	Lumen(±5%)	N.W/pc(kgs)	Q'ty/CTN
JDL34-3-13W	13W	110x110x44	90-95	940lm	0.40	24PCS
JDL34-6-25W	25W	190x190x54	160-170	2300lm	1.11	12PCS

CCT — 3000K 4000K 5000K 5700K

Trim — White Black Silver Chrome



# JDL96 Downlight

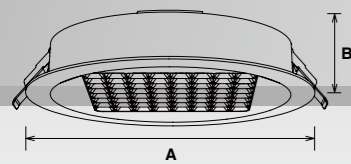

JDL96 LED downlight with SMD LED, plastic coated aluminum, round shape, internal driver. IP54 waterproof. Grilling design effectively reduce the UGR index. High lumen output 110lm/W. Push button looping connection terminal saves much installation time.

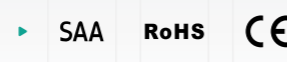
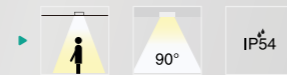

Code	Watt	Size(AxBmm)	Cut-out(mm)	Lumen(±5%)	N.W/pc(kgs)	Q'ty/CTN
JDL96-3-10W	10W	Ø110x40	Ø90-95	1070lm	0.22	30PCS
JDL96-6-18W	18W	Ø190x40	Ø160-170	2070lm	0.44	24PCS
JDL96-8-25W	25W	Ø228x40	Ø200-210	3000lm	0.70	20PCS



# JDL105 Downlight

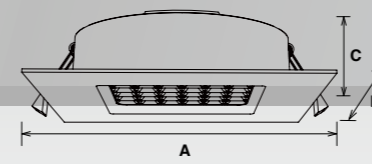

JDL105 LED downlight with SMD LED, plastic coated aluminum, square shape, internal driver. IP54 waterproof. Grilling design effectively reduce the UGR index. High lumen output 110lm/W. Push button looping connection terminal saves much installation time.

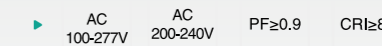
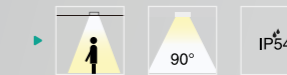

Code	Watt	Size(AxBxCmm)	Cut-out(mm)	Lumen(±5%)	N.W/pc(kgs)	Q'ty/CTN
JDL105-3-10W	10W	110x110x39	90-95	1070lm	0.24	30PCS
JDL105-6-18W	18W	190x190x43.5	160-170	2070lm	0.54	24PCS
JDL105-8-25W	25W	228x228x43.5	200-210	3000lm	0.84	20PCS

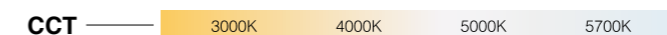



## JDL248A Downlight

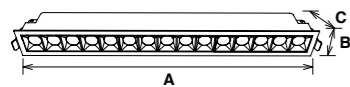

JDL248A is linear recessed downlight with symmetric beam, adopting CREE XP-G big power SMD light source with high lumen, CRI>90, SDCM<6. The aluminum die-casting frame with UV-proof white powder coating finishing provides an excellent thermal management. External flicker free driver and UGR<19 are available.

- ▶
- ▶
- ▶
- ▶

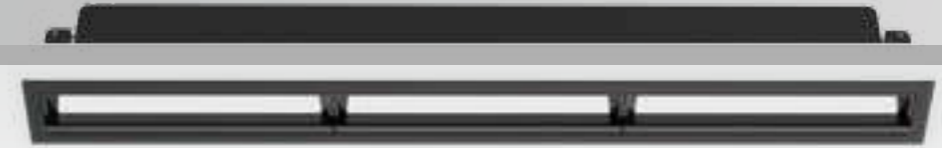

## JDL248B Downlight

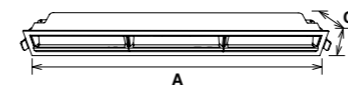

JDL248B is linear recessed downlight with asymmetric beam, adopting CREE XP-G big power SMD light source with high lumen, CRI>90, SDCM<6. The aluminum die-casting frame with UV-proof white powder coating finishing provides an excellent thermal management. External flicker free driver is available.

- ▶
- ▶
- ▶
- ▶





# JDL211A Downlight

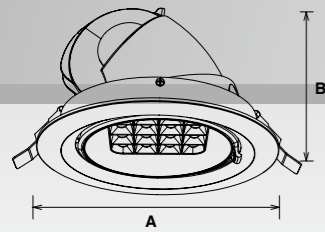

JDL211A LED downlight with high lumen SMD LED, ADC12 lamp body, scoop gimable design, external driver. Model A Lens+louver reflector is anti-glare design with comfortable eye visual. High lumen output up to 120lm/W.

- ▶ 60° 350° 40° IP40
- ▶ DIM DALI 0-10V
- ▶ AC 200-240V PF≥0.9 CRI≥80 CRI≥90
- ▶ CE

Code	Watt	Size(AxBmm)	Cut-out(mm)	Lumen(±5%)	N.W/pc(kgs)	Q'ty/CTN
JDL211A-6-25W	25W	Ø180x126	Ø165-170	2950lm	1.12	12PCS
JDL211A-6-33W	33W	Ø180x126	Ø165-170	3850lm	1.12	12PCS

CCT — 2700K 3000K 4000K 5000K

Trim — White Black



# JDL211B Downlight

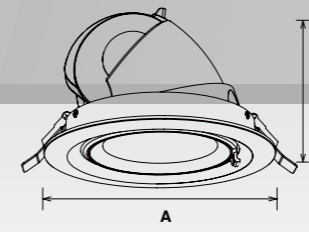

JDL211B LED downlight with high lumen SMD LED, ADC12 lamp body, scoop gimable design, external driver. Model B reflector+ diffuser design provides uniform lighting. CCT changed by slide switch is available.

- ▶ 110° 350° 40° IP40
- ▶ DIM DALI 0-10V SLIDE SWITCH 3 in 1
- ▶ AC 200-240V PF≥0.9 CRI≥80 CRI≥90
- ▶ CE

Code	Watt	Size(AxBmm)	Cut-out(mm)	Lumen(±5%)	N.W/pc(kgs)	Q'ty/CTN
JDL211B-6-25W	25W	Ø180x126	Ø165-170	2550lm	1.12	12PCS
JDL211B-6-33W	33W	Ø180x126	Ø165-170	3200lm	1.12	12PCS

CCT — 2700K 3000K 4000K 5000K

Trim — White Black



# JDL222 Downlight

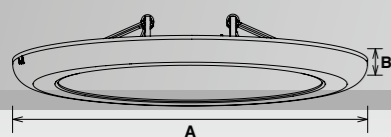

JDL222 LED downlight with SMD LED, AL1060 Aluminum lamp body, AC to DC internal driver, round shape. Recessed and surface mounted installation are available. Cutout size is adjustable from 65mm to 205mm for recessed installation. CCT and power is switchable for choice.

- ▶ 120°
- ▶ IP20
- ▶ DIM
- ▶ SMD SWITCH 3 in 1
- ▶ Adjustable Power
- ▶ AC 200-240V
- ▶ PF ≥ 0.9
- ▶ CRI ≥ 80
- ▶ SAA RoHS CE

Code	Watt	Size(AxBmm)	Cut-out(mm)	Lumen(±5%)	N.W/pc(kgs)	Q'ty/CTN
JDL222-8-16W	16W	Ø235x16	Ø65-205	1800lm	0.36	20PCS
JDL222-8-16W-D	16W	Ø235x16	Ø65-205	1800lm	0.36	20PCS
JDL222-8-16W-A3	10W/13W/16W	Ø235x16	Ø65-205	1800lm	0.36	20PCS
JDL222-8-16W-C3	16W	Ø235x16	Ø65-205	1800lm	0.36	20PCS
JDL222-8-16W-P3	16W	Ø235x16	Ø65-205	1800lm	0.36	20PCS
JDL222-8-16W-AC3	10W/13W/16W	Ø235x16	Ø65-205	1800lm	0.36	20PCS

CCT — 3000K 4000K 5000K 5700K

Trim — White



# JDL222B Downlight



JDL222B LED downlight with SMD LED, AL1060 aluminum lamp body, AC to DC internal driver, square shape. Recessed and surface mounted installation are available. Cutout size is adjustable from 65mm to 205mm for recessed installation. CCT and power is switchable for choice.

- ▶ 120°
- ▶ IP20
- ▶ DIM
- ▶ SMD SWITCH 3 in 1
- ▶ Adjustable Power
- ▶ AC 200-240V
- ▶ PF ≥ 0.9
- ▶ CRI ≥ 80
- ▶ SAA RoHS CE

Code	Watt	Size(AxBxCmm)	Cut-out(mm)	Lumen(±5%)	N.W/pc(kgs)	Q'ty/CTN
JDL222B-8-16W	16W	235x235x16	Ø65-205	1650lm	0.55	20PCS
JDL222B-8-16W-D	16W	235x235x16	Ø65-205	1650lm	0.55	20PCS
JDL222B-8-16W-A3	10W/13W/16W	235x235x16	Ø65-205	1800lm	0.55	20PCS
JDL222B-8-16W-C3	16W	235x235x16	Ø65-205	1800lm	0.55	20PCS
JDL222B-8-16W-P3	16W	235x235x16	Ø65-205	1800lm	0.55	20PCS
JDL222B-8-16W-AC3	10W/13W/16W	235x235x16	Ø65-205	1800lm	0.55	20PCS

CCT — 3000K 4000K 5000K 5700K

Trim — White



JDL280A



JDL280B

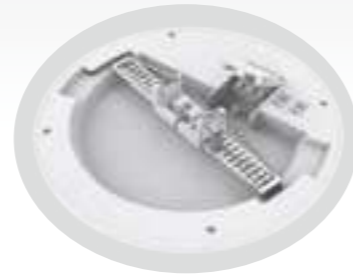

# JDL280 Downlight

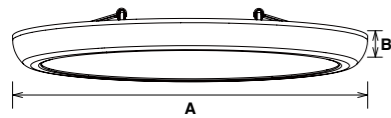

JDL280 is a downlight with adjustable cutout from 65~205mm and 120~260mm for recessed installation. Super slim with internal driver and quick connector makes installation easy. Interchangeable CCT and power with slide switch are available. Triac dimmable and flicker free are used.

- ▶ 120°
- ▶ IP20
- ▶ DIM
- ▶ SLIDE SWITCH 3 in 1
- ▶ Adjustable Power
- ▶ AC 100-240V
- ▶ PF ≥ 0.9
- ▶ CRI ≥ 80
- ▶ SAA
- ▶ RoHS
- ▶ CE

Code	Watt	Size(AxBmm)	Cut-out(mm)	Lumen(±5%)	N.W/pc(kgs)	Q'ty/CTN
JDL280-8-16W	16W	Ø235x22	Ø65-205	1700lm	0.46	20PCS
JDL280-10-24W	24W	Ø300x25	Ø120-260	2600lm	0.78	10PCS

CCT — 3000K — 4000K — 5000K — 5700K

Trim — White



# JDL94 Downlight

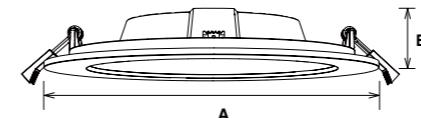

JDL94 LED downlight with SMD LED, plastic coated aluminum heat sink, internal driver. Super slim design only 33mm height.

- ▶ 120°
- ▶ IP40
- ▶ DIM
- ▶ AC 100-240V
- ▶ AC 200-240V
- ▶ PF ≥ 0.9
- ▶ CRI ≥ 80
- ▶ SAA
- ▶ RoHS
- ▶ CE



Code	Watt	Size(AxBmm)	Cut-out(mm)	Lumen(±5%)	N.W/pc(kgs)	Q'ty/CTN
JDL94-3-7W	7W	Ø110x30	Ø90-95	580lm	0.15	48PCS
JDL94-6-16W	16W	Ø190x33	Ø160-170	1730lm	0.40	24PCS
JDL94-8-20W	20W	Ø230x33	Ø200-210	2315lm	0.52	24PCS

CCT — 3000K — 4000K — 5000K — 5700K

Trim — White Black





# JDL134 Downlight

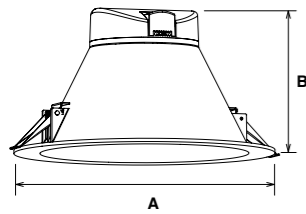

JDL134 LED downlight with SMD LED, plastic coated aluminum heat sink, internal driver. Deep trim design provides soft lighting. IP54 waterproof for internal use. CCT switchable by slide switch is available.

- ▶ 90°
- ▶
- ▶
- ▶



Code	Watt	Size(AxBmm)	Cut-out(mm)	Lumen(±5%)	N.W/pc(kgs)	Q'ty/CTN
JDL134-3-10W	10W	Ø115x83.4	Ø90-95	880lm	0.17	30PCS
JDL134-4-13W	13W	Ø145x97.5	Ø125-130	1230lm	0.25	24PCS
JDL134-6-16W	16W	Ø190x115.3	Ø160-170	1720lm	0.40	12PCS
JDL134-8-20W	20W	Ø240x132.5	Ø200-210	2150lm	0.55	12PCS

CCT — 3000K 4000K 5000K 5700K

Trim — White Silver



# JDL304 Downlight

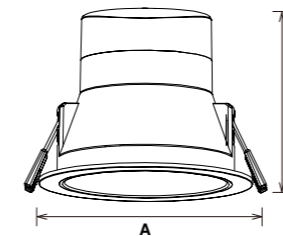

JDL304 LED downlight is a mini design, adopting high lumen SMD chip, deep lens with uniform light output and soft UGR<19 effect. IP54 in front part, IK06 protection level, and interchangeable CCT with slide switch are available. It offers a wide choice of options for creating the desired ambience.

- ▶ 36° 60°
- ▶
- ▶
- ▶

Code	Watt	Size(AxBmm)	Cut-out(mm)	Lumen(±5%)	N.W/pc(kgs)	Q'ty/CTN
JDL304-2.5-6W	6W	Ø85x84	Ø70	540lm	0.25	30PCS
JDL304-3-8W	8W	Ø106x84	Ø90	700lm	0.28	30PCS

CCT — 3000K 4000K 5700K

Trim — White Black



# JDL54 Downlight

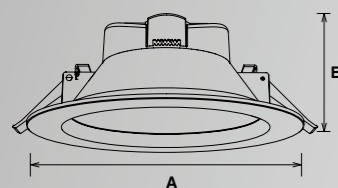

JDL54 LED downlight with SMD LED, plastic coated aluminum heat sink, internal driver. IP40/IP54 available for choice. CCT switchable by slide switch is available.

- ▶
- ▶
- ▶
- ▶



Code	Watt	Size(AxBmm)	Cut-out(mm)	Lumen(±5%)	N.W/pc(kgs)	Q'ty/CTN
JDL54C-2.5-7W-P3	7W	Ø85x68	Ø68-75	700lm	0.13	50PCS
JDL54C-3-8W	8W	Ø115x58	Ø90-95	750lm	0.20	30PCS
JDL54C-3-8W-C3(P3)	8W	Ø115x61	Ø90-95	750lm	0.20	30PCS
JDL54C-3-10W	10W	Ø115x58	Ø90-95	940lm	0.20	30PCS
JDL54C-3-10W-C3(P3)	10W	Ø115x61	Ø90-95	940lm	0.20	30PCS
JDL54B-4-13W	13W	Ø145x61	Ø120-130	1100lm	0.28	30PCS
JDL54B-4-13W-C3(P3)	13W	Ø145x62.5	Ø120-130	1300lm	0.28	30PCS
JDL54B-6-16W	16W	Ø190x74	Ø160-170	1550lm	0.51	30PCS
JDL54B-6-16W-C3(P3)	16W	Ø190x75.5	Ø160-170	1760lm	0.41	30PCS
JDL54B-8-20W	20W	Ø225x84	Ø200-210	1840lm	0.64	20PCS
JDL54B-8-20W-C3(P3)	20W	Ø225x84	Ø200-210	2100lm	0.52	20PCS

CCT — 3000K 4000K 5000K 5700K

Ring — 3inch

Trim — White



# JDL41 Downlight

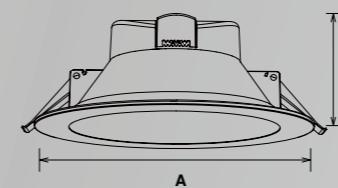

JDL41 LED downlight with SMD LED, PC diffuser, plastic coated aluminum heat sink, internal driver. IP54 waterproof for cover. CCT switchable by slide switch is available.

- ▶
- ▶
- ▶
- ▶



Code	Watt	Size(AxBmm)	Cut-out(mm)	Lumen(±5%)	N.W/pc(kgs)	Q'ty/CTN
JDL41C-2.5-7W	7W	Ø85x55	Ø70-75	620lm	0.12	50PCS
JDL41C-2.5-7W-C3(P3)	7W	Ø85x63	Ø70-75	650lm	0.12	50PCS
JDL41C-3-8W	8W	Ø115x58	Ø90-95	750lm	0.20	30PCS
JDL41C-3-8W-C3(P3)	8W	Ø115x61	Ø90-95	800lm	0.20	30PCS
JDL41C-3-10W	10W	Ø115x58	Ø90-95	880lm	0.20	30PCS
JDL41C-3-10W-C3(P3)	10W	Ø115x61	Ø90-95	940lm	0.20	30PCS
JDL41B-4-13W	13W	Ø145x61	Ø120-130	1210lm	0.22	30PCS
JDL41B-4-13W-C3(P3)	13W	Ø145x62.5	Ø120-130	1320lm	0.22	30PCS
JDL41B-6-16W	16W	Ø190x74	Ø160-170	1670lm	0.51	30PCS
JDL41B-6-16W-C3(P3)	16W	Ø190x75.5	Ø160-170	1840lm	0.51	30PCS
JDL41B-8-20W-C3(P3)	20W	Ø225x84	Ø200-210	2200lm	0.64	20PCS

CCT — 3000K 4000K 5000K 5700K

Ring — 2.5inch / 3inch

Trim — White



# JDL41-S1 Downlight

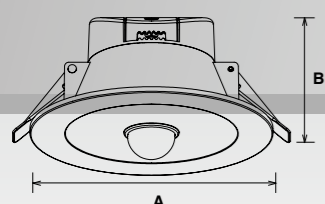

JDL41-S1 LED downlight with PIR sensor function, SMD LED, PC diffuser, plastic coated aluminum heat sink, internal driver. IP54 waterproof for cover. CCT switchable by slide switch is available.

- ▶
- ▶
- ▶
- ▶

Code	Watt	Size(AxBmm)	Cut-out(mm)	Lumen(±5%)	N.W/pc(kgs)	Q'ty/CTN
JDL41-3-8W-S1	8W	Ø115x70	Ø90-95	730lm	0.20	30PCS
JDL41-3-10W-S1	10W	Ø115x73	Ø90-95	880lm	0.20	30PCS

CCT ——— 3000K 4000K 5000K 5700K

Trim ——— White Silver



# JDL41D Downlight

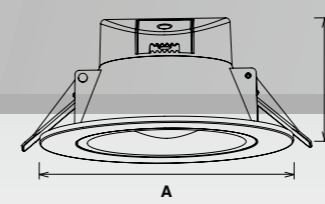

JDL41D LED downlight with SMD LED, high light transmittance lens, plastic coated aluminum heat sink, internal driver. IP54 waterproof for cover. CCT switchable by slide switch is available.

- ▶
- ▶
- ▶
- ▶

Code	Watt	Size(AxBmm)	Cut-out(mm)	Lumen(±5%)	N.W/pc(kgs)	Q'ty/CTN
JDL41D-3-10W-D	10W	Ø115x58	Ø90-95	900lm	0.20	30PCS
JDL41D-3-10W-P3	10W	Ø115x61	Ø90-95	980lm	0.20	30PCS

CCT ——— 3000K 4000K 5000K 5700K

Trim ——— White Silver



# JDL245 Downlight

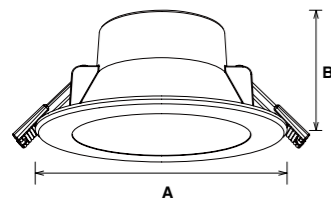

JDL245 CCT switchable downlight adopts high efficiency SMD LED chips, opal PC diffuser and plastic covered aluminium housing. Internal dimmable driver is compatible with most dimmers in the market with smooth dimming performance.

- ▶ 90° IP44
- ▶ DIM 3 in 1
- ▶ AC 220-240V PF≥0.9 CRI≥80
- ▶ RoHS CE

Code	Watt	Size(AxBmm)	Cut-out(mm)	Lumen(±5%)	N.W/pc(kgs)	Q'ty/CTN
JDL245-3-8W-P3	8W	Ø115x54	Ø90-95	800lm	0.16	24PCS

CCT — 3000K — 4000K — 5700K

Trim — White Black Silver Chrome





# JDL294A/B/C Downlight

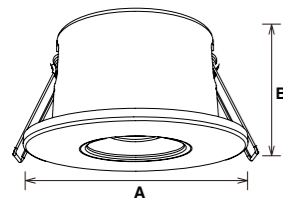

JDL294 LED downlight adopts fireproof bracket and aluminium heat sink, which not only meets the fireproof structure demand but also offers a good heat dissipation performance. Four cover options: white, black, silver and nickel brushed. The cover is fixed by magnetic design, and it has a hidden slide switch for CCT, convenient for CCT change and cover change.

- ▶ 30° 36° 60°
- ▶ IP65 IP40 IP20
- ▶ DIM SLIDE SWITCH 3 in 1
- ▶ AC 220-240V PF<sub>≥</sub>0.85 CRI<sub>≥</sub>80
- ▶ RoHS CE

Code	Watt	Size(AxBmm)	Cut-out(mm)	Lumen(±5%)	N.W/pc(kgs)	Q'ty/CTN
JDL294A-2.5-6W-D	6W	Ø85x61	Ø68-75	650lm	0.21	36PCS
JDL294A-2.5-6W-P3	6W	Ø85x61	Ø68-75	650lm	0.21	36PCS
JDL294B-2.5-6W-D	6W	Ø85x81	Ø68-75	550lm	0.23	36PCS
JDL294B-2.5-6W-P3	6W	Ø85x81	Ø68-75	550lm	0.23	36PCS
JDL294C-2.5-6W-D	6W	Ø95x82	Ø78-85	650lm	0.30	36PCS
JDL294C-2.5-6W-P3	6W	Ø95x82	Ø78-85	650lm	0.30	36PCS

CCT — 3000K 4000K 5000K 5700K

Trim — Black

Ring —

# JDL294 SERIES

Fireproof: 30Min/60Min/90Min

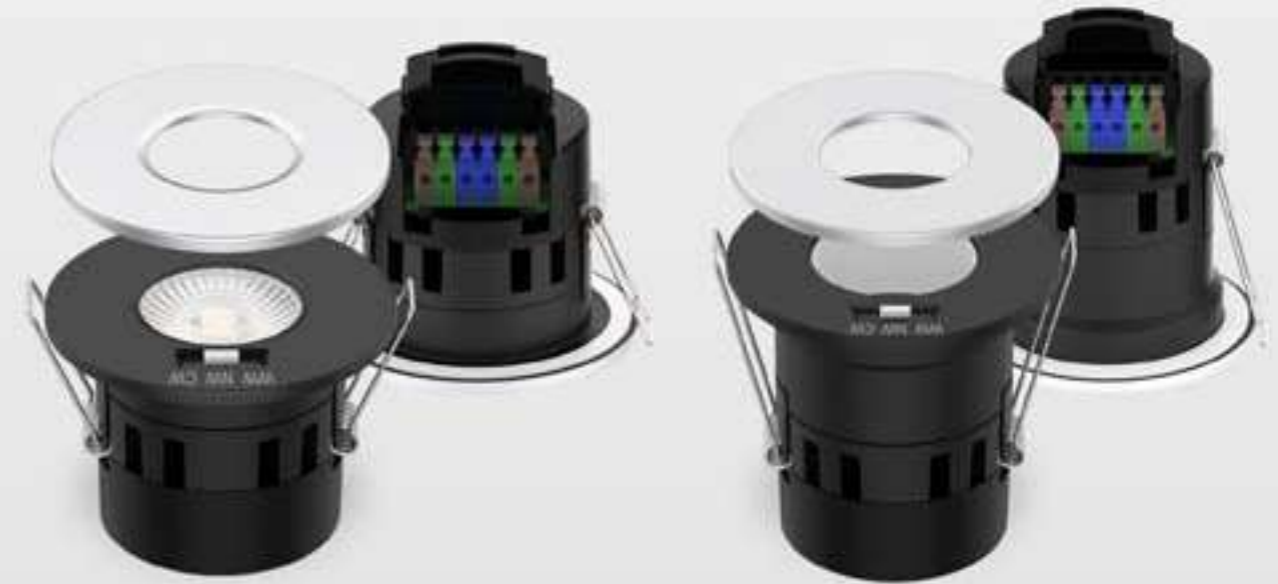

JDL294A Replaceable cover



JDL294B Replaceable cover



JDL294C





## JDL260 Downlight

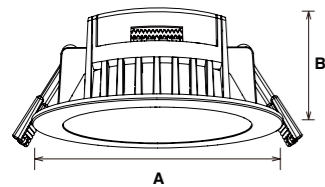

JDL260 slimline downlight adopts high efficiency SMD LED chips, opal PC diffuser and plastic covered aluminium housing. Flat surface design integrates well into ceiling. Internal dimmable driver is compatible with most dimmers in the market with smooth dimming performance.

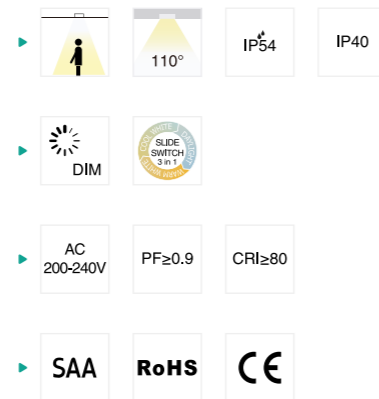

Code	Watt	Size(AxBmm)	Cut-out(mm)	Lumen(±5%)	N.W/pc(kgs)	Q'ty/CTN
JDL260A-3-8W	8W	Ø106x40	Ø90-95	800lm	0.15	45PCS
JDL260B-3-8W	8W	Ø106x40	Ø90-95	800lm	0.19	45PCS



## JDL261 Downlight

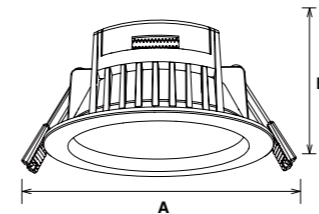

JDL261 slimline downlight adopts high efficiency SMD LED chips, opal PC diffuser and plastic covered aluminium housing. Stepped surface design reduces glare rate effectively. Internal dimmable driver is compatible with most dimmers in the market with smooth dimming performance.

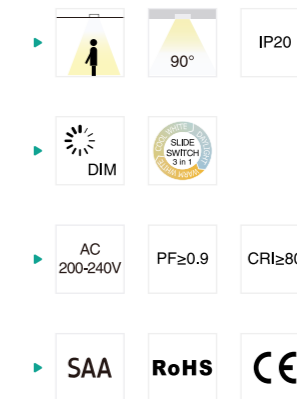

Code	Watt	Size(AxBmm)	Cut-out(mm)	Lumen(±5%)	N.W/pc(kgs)	Q'ty/CTN
JDL261A-3-8W	8W	Ø106x47	Ø90-95	800lm	0.20	30PCS
JDL261B-3-8W	8W	Ø106x47	Ø90-95	800lm	0.20	30PCS



JDL256A



JDL256B

## JDL270 Downlight

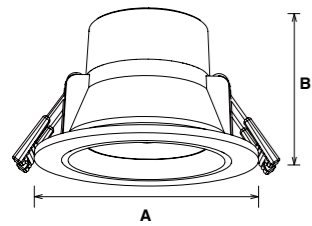

JDL270 LED downlight is low UGR design with internal driver, adopting high lumen SMD which could reach 105lm/W, special lens with uniform and soft lighting, quick terminal makes installation easier. The plastic coated aluminum improves the stability and safety. Interchangeable CCT with slide switch is available.

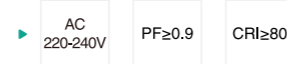
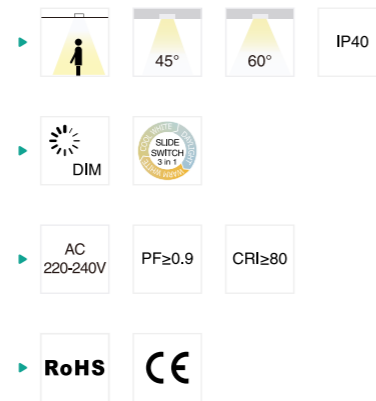

Code	Watt	Size(AxBmm)	Cut-out(mm)	Lumen(±5%)	N.W/pc(kgs)	Q'ty/CTN
JDL270-2.5-5W-D	5W	Ø85x55	Ø68-75mm	530lm	0.15	50PCS
JDL270-2.5-5W-P3	5W	Ø85x57.5	Ø68-75mm	530lm	0.19	50PCS

## JDL256 Downlight

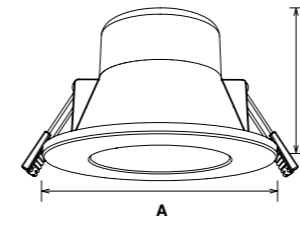

JDL256 compact downlight adopts high efficiency SMD LED chips, opal PC diffuser and plastic covered aluminium housing. Front CCT adjustable switch, with exchangeable bezels magnetic onto main body. Internal dimmable driver is compatible with most dimmers in the market with smooth dimming performance.

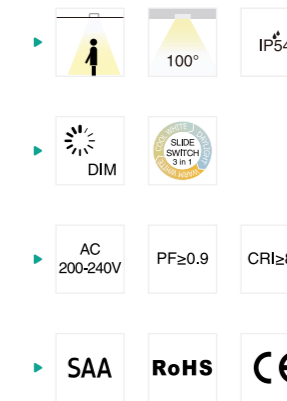

Code	Watt	Size(AxBmm)	Cut-out(mm)	Lumen(±5%)	N.W/pc(kgs)	Q'ty/CTN
JDL256A-3-8W-P3	8W	Ø110x67.5	Ø90-95mm	800lm	0.15	36PCS
JDL256B-3-8W -P3	8W	Ø110x67.5	Ø90-95mm	800lm	0.17	36PCS



## JDL192 Downlight

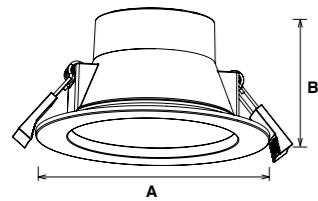

JDL192 compact downlight adopts high efficiency SMD LED chips, opal PC diffuser and plastic covered aluminium housing. Stepped surface design reduces glare rate effectively. Internal dimmable driver is compatible with most dimmers in the market with smooth dimming performance.

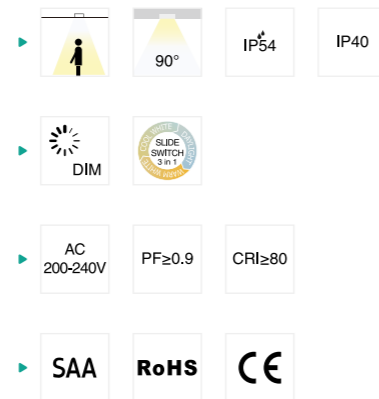

Code	Watt	Size(AxBmm)	Cut-out(mm)	Lumen(±5%)	N.W/pc(kgs)	Q'ty/CTN
JDL192-3-10W-D	10W	Ø115x60	Ø90-95	870lm	0.18	30PCS
JDL192-3-10W-P3	10W	Ø115x62.6	Ø90-95	1000lm	0.18	30PCS



## JDL174 Downlight

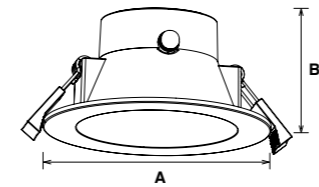

JDL174 compact downlight adopts high efficiency SMD LED chips, opal PC diffuser and plastic covered aluminium housing. Flat surface design integrates well into ceiling. Internal dimmable driver is compatible with most dimmers in the market with smooth dimming performance.

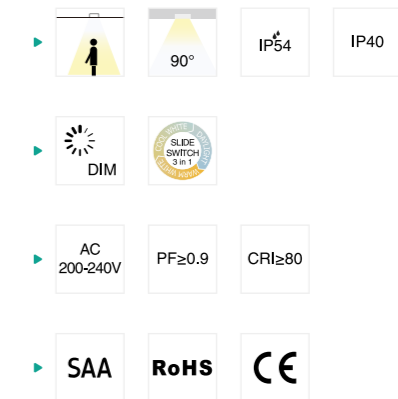

Code	Watt	Size(AxBmm)	Cut-out(mm)	Lumen(±5%)	N.W/pc(kgs)	Q'ty/CTN
JDL174-2.5-7W-D	7W	Ø85x57	Ø68-75	630lm	0.14	50PCS
JDL174-2.5-7W-P3	7W	Ø85x59.6	Ø68-75	720lm	0.14	50PCS
JDL174-3-10W-D	10W	Ø115x57	Ø90-95	870lm	0.18	30PCS
JDL174-3-10W-P3	10W	Ø115x59.6	Ø90-95	1000lm	0.18	30PCS



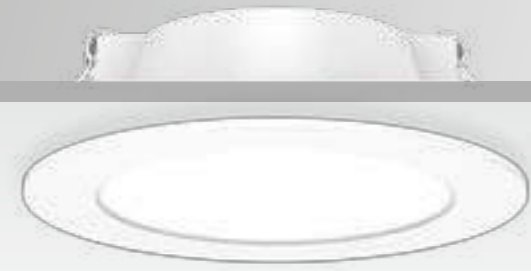

JDL199A



JDL199B



## JDL199 Downlight

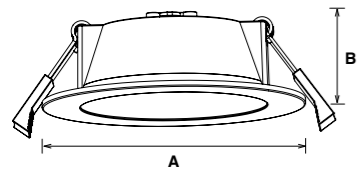

JDL199 slimline downlight adopts high efficiency SMD LED chips, opal PC diffuser and plastic covered aluminium housing. Flat (A) or Stepped (B) surface design optional. Internal DOB driver for single CCT version. External linear driver integrated with slide switch for Tri-CCT version. Dimmable driver is compatible with most dimmers in the market with smooth dimming performance.

- ▶ 90°
- ▶
- ▶
- ▶

Code	Watt	Size(AxBmm)	Cut-out(mm)	Lumen(±5%)	N.W/pc(kgs)	Q'ty/CTN
JDL199A-3-7W-D	7W	Ø115x40	Ø90-95	630lm	0.12	30PCS
JDL199A-3-7W-P3	7W	Ø115x40	Ø90-95	650lm	0.12	30PCS
JDL199B-3-7W-D	7W	Ø115x43	Ø90-95	630lm	0.12	30PCS
JDL199B-3-7W-P3	7W	Ø115x43	Ø90-95	650lm	0.12	30PCS

CCT — 3000K 4000K 5000K 5700K

Trim — White

## JCL101 Downlight

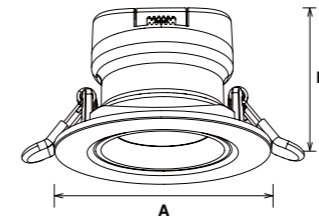

JCL101 rotatable downlight adopts high efficiency SMD LED chips, TIR (Total Internal Reflection) lens and plastic covered aluminium housing. Sharp light distribution makes it an ideal choice for accent lighting purpose.

- ▶ 36° 60°
- ▶
- ▶
- ▶

Code	Watt	Size(AxBmm)	Cut-out(mm)	Lumen(±5%)	N.W/pc(kgs)	Q'ty/CTN
JCL101-2.5-7W	7W	Ø85x64.5	Ø70-75	660lm	0.20	36PCS
JCL101-3-10W	10W	Ø105x71.5	Ø90-95	950lm	0.25	36PCS

CCT — 3000K 4000K 5000K 5700K

Trim — White



## JDL91 Downlight

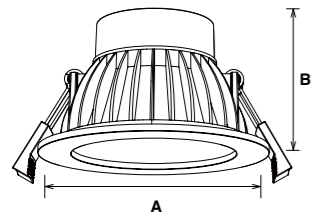

JDL91 integrated downlight adopts high efficiency SMD LED chips, opal PC diffuser, plastic covered aluminium housing and internal dimmable driver. Dimmable driver is compatible with most dimmers in the market with smooth dimming performance. Dual-CCT or Tri-CCT switchable optional. Silver, white and black exchangeable rings.

- ▶ 90° IP54 IP40
- ▶ DIM SLIDE SWITCH 3 in 1
- ▶ AC 200-240V PF≥0.9 CRI≥80
- ▶ SAA RoHS CE

Code	Watt	Size(AxBmm)	Cut-out(mm)	Lumen(±5%)	N.W/pc(kgs)	Q'ty/CTN
JDL91-3-8W-P2	8W	Ø107.5x71.5	Ø90-95	780lm	0.29	30PCS
JDL91-3-10W-P2	10W	Ø107.5x71.5	Ø90-95	900lm	0.29	30PCS
JDL91-3-8W-P3	8W	Ø107.5x71.5	Ø90-95	800lm	0.29	30PCS
JDL91-3-10W-P3	10W	Ø107.5x71.5	Ø90-95	900lm	0.29	30PCS

CCT ——— 3000K 4000K 5000K 5700K



Trim ——— White



## JDL143 & JDL144 Downlight

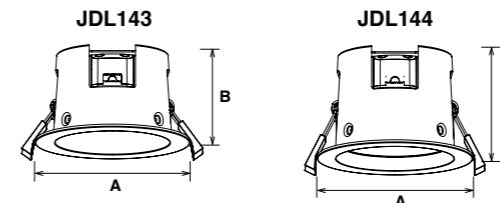

JDL143 RGB smart downlight adopts Tuya wireless intelligent solution. Each lamp could be controlled individually or by grouping through corresponding app for different lighting application needs: CCT adjustable from 3000K~5700K / RGB, brightness adjustable, synchronizing with music. Work with ALEXA, GOOGLE Assistant, IFTTT, ROKID, Tmall Genie etc.

- ▶ 90° IP54
- ▶ DIM SLIDE SWITCH 3 in 1 2.4G WIFI
- Bluetooth Music RGB Smart Lighting
- ▶ AC 200-240V PF≥0.5 CRI≥80
- ▶ SAA RoHS CE

Code	Watt	Size(AxBmm)	Cut-out(mm)	Lumen(±5%)	N.W/pc(kgs)	Q'ty/CTN
JDL143-3-10W	10W	Ø110x64	Ø90-95	850lm	0.22	36PCS
JDL144-3-10W	10W	Ø110x74	Ø90-95	780lm	0.24	36PCS

CCT ——— 3000K-5700K

Trim ——— White Black



# JDL229 Downlight

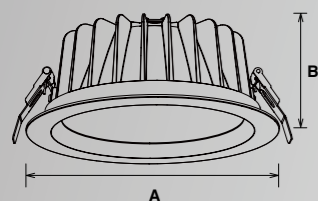

JDL229 commercial downlight adopts high power COB LED chip, reflector and tempered glass, ADC12 aluminum heatsink. External driver is exchangeable through quick connector among non-dimmable driver, Triac dimmable, 0-10V and DALI dimmable drivers.

- ▶ 24° 36° 45° 60° IP54
- ▶ DIM DALI 0-10V
- ▶ AC 200-240V PF $\geq$ 0.9 CRI $\geq$ 80 CRI $\geq$ 90 CRI $\geq$ 97 SDCM <6
- ▶ SAA RoHS CE



Code	Watt	Size(AxBmm)	Cut-out(mm)	Lumen(±5%)	N.W/pc(kgs)	Q'ty/CTN
JDL229-3-10W	10W	Ø110x53	Ø90-95	988lm	0.25	30PCS
JDL229-3-12W	12W	Ø110x53	Ø90-95	1312lm	0.25	30PCS
JDL229-4-12W	12W	Ø145x65	Ø120-130	1485lm	0.41	20PCS
JDL229-4-18W	18W	Ø145x65	Ø120-130	1997lm	0.41	20PCS
JDL229-4-25W	25W	Ø145x65	Ø120-130	2733lm	0.41	20PCS
JDL229-6-18W	18W	Ø190x75	Ø160-170	2079lm	0.69	12PCS
JDL229-6-25W	25W	Ø190x75	Ø160-170	2798lm	0.69	12PCS
JDL229-6-33W	33W	Ø190x75	Ø160-170	3674lm	0.69	12PCS
JDL229-8-18W	18W	Ø225x87	Ø200-210	2066lm	0.96	12PCS
JDL229-8-25W	25W	Ø225x87	Ø200-210	2801lm	0.96	12PCS
JDL229-8-33W	33W	Ø225x87	Ø200-210	3659lm	0.96	12PCS
JDL229-8-42W	42W	Ø225x87	Ø200-210	4823lm	0.96	12PCS

CCT — 2700K 3000K 4000K 5000K

Trim — White Black



# JDL22 Downlight

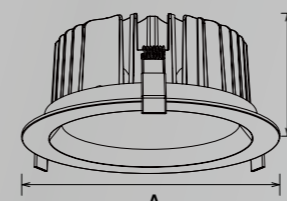

JDL22 the most classic commercial downlight adopts brand CITIZEN COB, reflector and tempered glass, ADC12 aluminum heatsink and bezel. The sophisticated ADC12 heatsink design is unique and serves the purpose of superb heat dissipation. External driver is exchangeable through quick connector among non-dimmable driver, Triac dimmable, 0-10V and DALI dimmable drivers. Tunable White option adopts dual color temperature COB and dual DALI driver, supports the concept of Human Centric Lighting (HCL), widely applicable in health care center, nursing home, school etc.

- ▶ 24° 36° 45° 60° IP44 IP20
- ▶ DIM DALI 0-10V TUNABLE WHITE SLIDE SWITCH 3:1
- ▶ AC 100-240V AC 200-240V PF $\geq$ 0.9 CRI $\geq$ 80 CRI $\geq$ 90 CRI $\geq$ 97
- ▶ SAA RoHS CE



Code	Watt	Size(AxBmm)	Cut-out(mm)	Lumen(±5%)	N.W/pc(kgs)	Q'ty/CTN
JDL22-3-10W	10W	Ø110x53	Ø90-100	800lm	0.35	30PCS
JDL22-3-13W	13W	Ø110x53	Ø90-100	1100lm	0.35	30PCS
JDL22-4-18W	18W	Ø145x65	Ø120-130	2105lm	0.85	20PCS
JDL22-4-25W	25W	Ø145x65	Ø120-130	2750lm	0.85	20PCS
JDL22-6-18W	18W	Ø190x75	Ø160-170	2160lm	1.04	12PCS
JDL22-6-25W	25W	Ø190x75	Ø160-170	2875lm	1.04	12PCS
JDL22-6-35W	35W	Ø190x75	Ø160-170	3955lm	1.08	12PCS
JDL22-6-45W	45W	Ø190x75	Ø160-170	4770lm	1.08	12PCS
JDL22-8-18W	18W	Ø225x87	Ø200-210	2160lm	1.48	12PCS
JDL22-8-25W	25W	Ø225x87	Ø200-210	2875lm	1.48	12PCS
JDL22-8-35W	35W	Ø225x87	Ø200-210	3955lm	1.48	12PCS
JDL22-8-45W	45W	Ø225x87	Ø200-210	4770lm	1.48	12PCS

CCT — 2700K 3000K 4000K 5000K

Trim — White Black Silver



# JDL113 Downlight

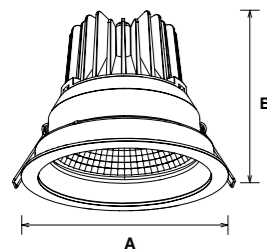

JDL113 unique downlight adopts brand CITIZEN COB, reflector and tempered glass, ADC12 aluminum heatsink. Deep reflector reduces glare rate effectively. External driver is exchangeable through quick connector among non-dimmable driver, Triac dimmable, 0-10V and DALI dimmable drivers.

- ▶ 60° IP20
- ▶ DIM DALI 0-10V
- ▶ AC 200-240V PF≥0.9 CRI≥80 CRI≥90 CRI≥97
- ▶ SAA RoHS CE

Code	Watt	Size(AxBmm)	Cut-out(mm)	Lumen(±5%)	N.W/pc(kgs)	Q'ty/CTN
JDL113-4-13W	13W	Ø150x123	Ø135-140	1520lm	0.85	12PCS
JDL113-4-20W	20W	Ø150x123	Ø135-140	2280lm	0.85	12PCS
JDL113-4-25W	25W	Ø150x123	Ø135-140	2810lm	0.85	12PCS

CCT — 2700K 3000K 4000K 5000K

Trim — White Black Silver



# JDL122 Downlight

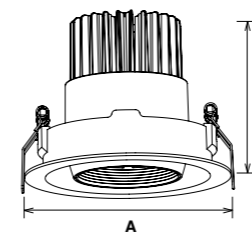

JDL122 Gimbal downlight adopts brand CITIZEN COB, exchangeable reflector and tempered glass, ADC12 aluminum heatsink. Horizontally 355° and vertically 30° rotatable. External driver is exchangeable through quick connector among non-dimmable driver, Triac dimmable, 0-10V and DALI dimmable drivers.

- ▶ 24° 45° 60° 355° 30° IP20
- ▶ DIM DALI 0-10V
- ▶ AC 200-240V PF≥0.9 CRI≥80 CRI≥90 CRI≥97
- ▶ SAA RoHS CE

Code	Watt	Size(AxBmm)	Cut-out(mm)	Lumen(±5%)	N.W/pc(kgs)	Q'ty/CTN
JDL122-4-18W	18W	Ø150x116	Ø130-140	1820lm	0.71	12PCS
JDL122-4-25W	25W	Ø150x116	Ø130-140	2430lm	0.71	12PCS
JL122-6-25W	25W	Ø185x130	Ø160-170	2420lm	1.10	12PCS
JDL122-6-35W	35W	Ø185x130	Ø160-170	3260lm	1.10	12PCS
JDL122-6-42W	42W	Ø185x130	Ø160-170	3780lm	1.10	12PCS

CCT — 2700K 3000K 4000K 5000K

Trim — White Black



# JDL297A Downlight

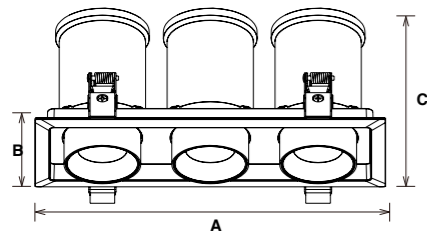

JDL297A LED downlight adopts high lumen COB light source, the special optic lens and reflector design offer a uniform light output and low glare effect. It is an extension design, 360 degree horizontal rotation and 68 degree vertically rotation. And it has round shape, square shape with single/ double/triple heads which is suitable for various application area.

- ▶ 24° 36° IP20
- ▶ DIM
- ▶ AC 200-240V PF≥0.9 CRI≥80 CRI≥90
- ▶ RoHS



Code	Watt	Size(AxBxCmm)	Cut-out(mm)	Lumen(±5%)	N.W/pc(kgs)	Q'ty/CTN
JDL297A-2.5-10W/15W	10W/15W	Ø100x114	Ø83-90	850lm/1300lm	0.50	50PCS
JDL297A-1010-10W/15W	10W/15W	100x100x114	83-90x83-90	850lm/1300lm	0.50	36PCS
JDL297A-1018-20W/30W	20W/30W	180x100x114	85-90x165-170	1700lm/2500lm	0.90	36PCS
JDL297A-1026-30W/45W/42W	30W/45W/42W	260x100x114	85-90x245-250	2500lm/3800lm /3350lm	1.50	30PCS

CCT — 2700K 3000K 4000K 5000K

Trim — White Black

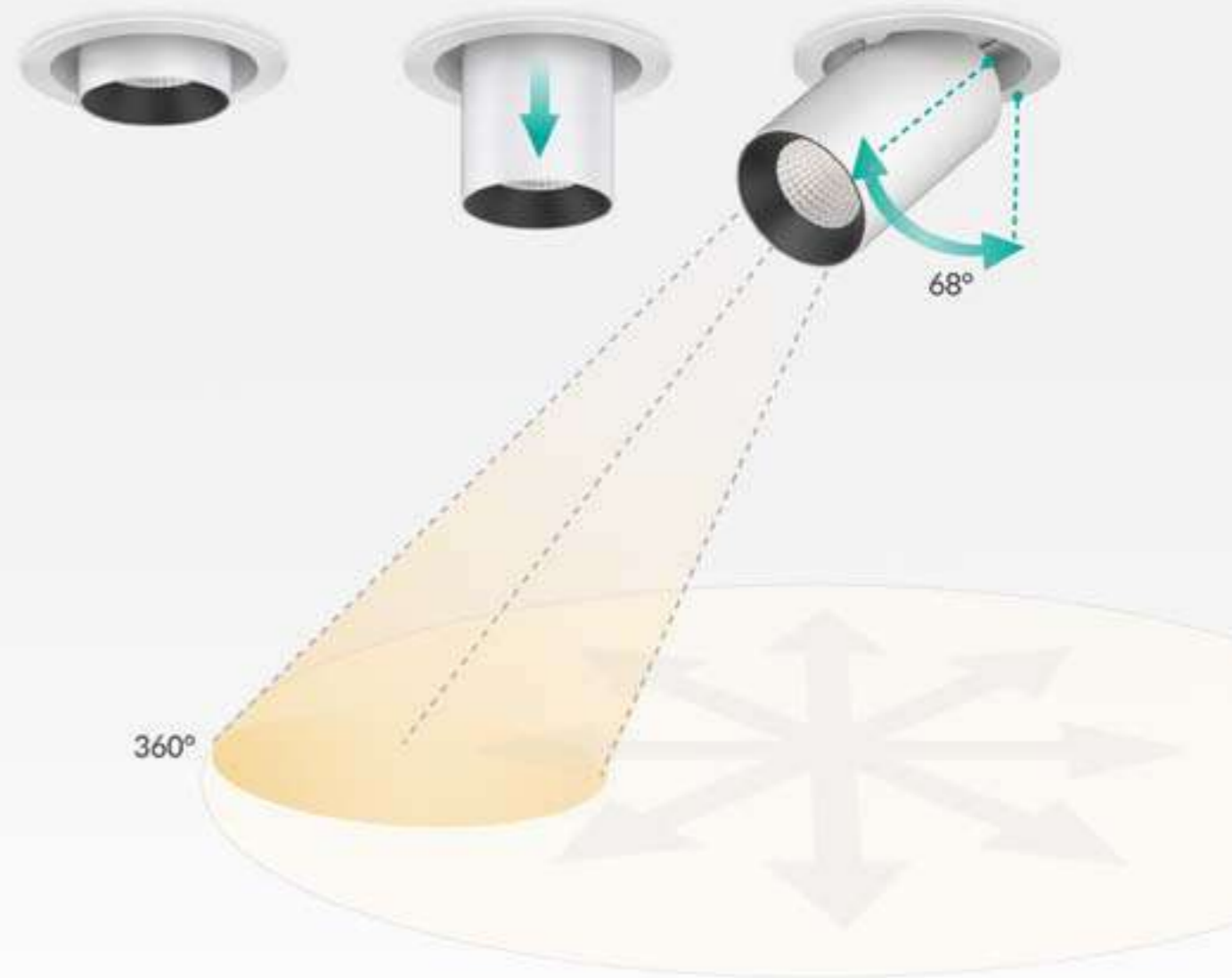

## JDL297 SERIES

JDL297A Series Extension Design  
Adjustable Downlight



# JDL77 Downlight

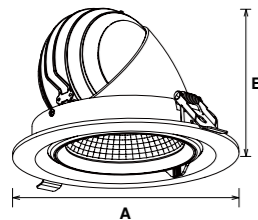

JDL77 Gimbal downlight adopts brand CITIZEN COB, reflector and tempered glass, ADC12 aluminum heatsink. External driver is exchangeable through quick connector among non-dimmable driver, Triac dimmable, 0-10V and DALI dimmable drivers.

- ▶ 15° 24° 36° 45° 60°
- ▶ 350° 35°
- ▶ 35°
- ▶ IP20
- ▶ DIM DALI 0-10V
- ▶ AC 200-240V PF≥0.9 CRI≥80 CRI≥90 CRI≥97
- ▶ RoHS CE CB

Code	Watt	Size(AxBmm)	Cut-out(mm)	Lumen(±5%)	N.W/pc(kgs)	Q'ty/CTN
JDL77-2.5-10W	10W	Ø96x68	Ø85-90	800lm	0.25	36PCS
JDL77-4-15W	15W	Ø145x102	Ø120-130	1800lm	0.57	18PCS
JDL77-4-20W	20W	Ø145x102	Ø120-130	2100lm	0.57	18PCS
JDL77-6-35W	35W	Ø180x128.5	Ø165-170	3800lm	1.07	12PCS
JDL77-6-45W	45W	Ø180x128.5	Ø165-170	5080lm	1.07	12PCS

CCT — 2700K 3000K 4000K 5000K Trim — White Black Silver

# JDL31 Downlight

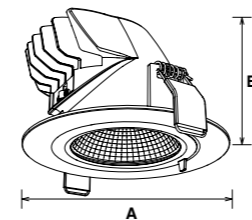

JDL31 Gimbal downlight adopts brand CITIZEN COB, reflector and tempered glass, ADC12 aluminum heatsink. External driver is exchangeable through quick connector among non-dimmable driver, Triac dimmable, 0-10V and DALI dimmable drivers.

- ▶ 24° 45° 60° 45°
- ▶ IP20
- ▶ DIM DALI 0-10V
- ▶ AC 100-240V AC 200-240V PF≥0.9 CRI≥80 CRI≥90 CRI≥97
- ▶ SAA RoHS CE

Code	Watt	Size(AxBmm)	Cut-out(mm)	Lumen(±5%)	N.W/pc(kgs)	Q'ty/CTN
JDL31-2.5-13W	13W	Ø96x67	Ø85-88	945lm	0.39	24PCS
JDL31-6-18W	18W	Ø180x100	Ø160-170	1530lm	1.41	12PCS
JDL31-6-25W	25W	Ø180x100	Ø160-170	2550lm	1.41	12PCS
JDL31-6-35W	35W	Ø180x100	Ø160-170	3550lm	1.41	12PCS

CCT — 2700K 3000K 4000K 5000K Trim — White Black Silver Chrome



# JCL108 Downlight

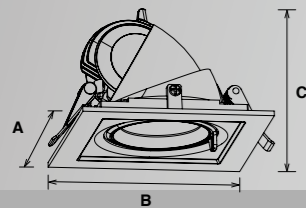

JCL108 Gimbal downlight adopts brand CITIZEN COB, reflector and tempered glass, ADC12 aluminum heatsink. Square modular design allows various DIY combinations through splicing plates. External driver is exchangeable through quick connector among non-dimmable driver, Triac dimmable, 0-10V and DALI dimmable drivers.

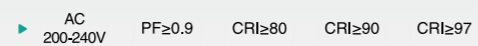
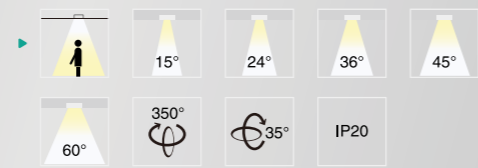

Code	Watt	Size(AxBxCmm)	Cut-out(mm)	Lumen(±5%)	N.W/pc(kgs)	Q'ty/CTN
JCL108-2.5-10W	10W	100x100x70	85-85	780lm	0.29	36PCS
JCL108-4-15W	15W	145x145x107	125-125	1290lm	0.60	18PCS
JCL108-4-20W	20W	145x145x107	125-125	2100lm	0.60	18PCS
JCL108-6-35W	35W	180x180x129	165-165	3800lm	1.07	12PCS
JCL108-6-45W	45W	180x180x129	165-165	4350lm	1.07	12PCS

CCT — 2700K — 3000K — 4000K — 5000K

Trim — White Black





## JCL113A Downlight

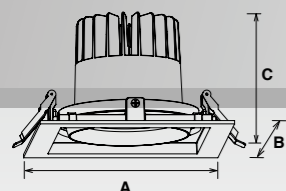

JCL113A Gimbal downlight adopts brand CITIZEN COB, reflector and tempered glass, ADC12 aluminum heatsink. Square modular design allows various DIY combinations through splicing plates. External driver is exchangeable through quick connector among non-dimmable driver, Triac dimmable, 0-10V and DALI dimmable drivers.

- ▶ 15° 24° 36°
- ▶ 30° 30°
- ▶ IP20
- ▶
- ▶
- ▶



Code	Watt	Size(AxBxCmm)	Cut-out(mm)	Lumen(±5%)	N.W/pc(kgs)	Q'ty/CTN
JCL113A-6-25W	25W	175x175x110	150-160	2750lm	0.83	18PCS
JCL113A-6-35W	35W	175x175x110	150-160	3850lm	0.83	18PCS

CCT — 2700K — 3000K — 4000K — 5000K

Trim — White Black

## JCL113B Downlight

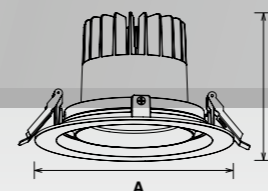

JCL113B Gimbal downlight adopts brand CITIZEN COB, reflector and tempered glass, ADC12 aluminum heatsink. External driver is exchangeable through quick connector among non-dimmable driver, Triac dimmable, 0-10V and DALI dimmable drivers.

- ▶ 15° 24° 36°
- ▶ 30° 30°
- ▶ IP20
- ▶
- ▶
- ▶

Code	Watt	Size(AxBmm)	Cut-out(mm)	Lumen(±5%)	N.W/pc(kgs)	Q'ty/CTN
JCL113B-6-25W	25W	Ø180x110	Ø150-160	2750lm	0.79	18PCS
JCL113B-6-35W	35W	Ø180x110	Ø150-160	3850lm	0.79	18PCS

CCT — 2700K — 3000K — 4000K — 5000K

Trim — White Black





L1

R1

# JDL170 Downlight

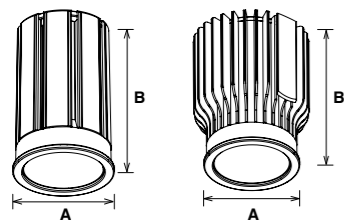

JDL170 downlight module adopts brand CITIZEN COB, lens (L) / reflector (R) and AL6063 aluminum heatsink. Various frames are selectable for different applications: round/ square, fixed/ rotatable, symmetric/ asymmetric, flat/ deep, oval hole/ circular hole frame. External driver is exchangeable through quick connector among non-dimmable driver, Triac dimmable, 0-10V and DALI dimmable drivers.

- ▶ 36° 60° IP20
- ▶ DIM DALI 0-10V
- ▶ AC 220-240V PF≥0.9 CRI≥80 CRI≥90 CRI≥97
- ▶ RoHS CE



L

R

Code	Watt	Size(AxBxCmm)	Cut-out(mm)	Lumen(±5%)	N.W/pc(kgs)	Q'ty/CTN
JDL170-10W	10W	Ø50x61	Trim	1000lm	0.17	100PCS
JDL170-13W	13W	Ø50x61	Trim	1490lm	0.17	100PCS
JDL170-18W	18W	Ø50x81	Trim	2130lm	0.25	50PCS
JDL170-75-A	Trim	Ø85x46.8x75	Ø75-80	Trim	0.08	100PCS
JDL170-90-A	Trim	Ø100x45.8x90	Ø90-95	Trim	0.09	100PCS
JDL170-100-A	Trim	110x35x95	95-100	Trim	0.16	80PCS
JDL170-90-B	Trim	Ø100x64x90	Ø90-95	Trim	0.10	100PCS
JDL170-75-B1	Trim	Ø85x34.5x70	Ø70-80	Trim	0.11	100PCS
JDL170-75-B2	Trim	Ø85x34.5x70	Ø70-80	Trim	0.11	100PCS
JDL170-75-C	Trim	Ø90x24.8x70	Ø70-80	Trim	0.07	100PCS
JDL170-90-D	Trim	Ø110x32x90	Ø90-95	Trim	0.11	100PCS
JDL170-90-E	Trim	100x50x90	90-95	Trim	0.12	100PCS

CCT 2700K 3000K 4000K 5000K

Trim White Black Silver

## JDL170 DIY module

JDL170-75-A

JDL170-90-A

JDL170-100-A

JDL170-90-B

JDL170-75-B1

JDL170-75-B2

JDL170-75-C

JDL170-90-D

JDL170-90-E



# JDL206 Downlight

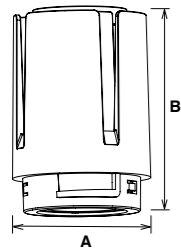

JDL206 downlight module adopts brand CITIZEN COB, lens and AL6063 aluminum heatsink. Fixed and rotatable frames are optional. External driver is exchangeable through quick connector among non-dimmable driver, Triac dimmable, 0-10V and DALI dimmable drivers.

- ▶ 36° 60°
- ▶ IP20
- ▶ DIM
- ▶ AC 220-240V PF $\geq$ 0.9 CRI $\geq$ 80 CRI $\geq$ 90 CRI $\geq$ 97
- ▶ RoHS CE

Code	Watt	Size(AxBxCmm)	Cut-out(mm)	Lumen( $\pm$ 5%)	N.W/pc(kgs)	Q'ty/CTN
JDL206-10W	10W	Ø49x72	Trim	850lm	0.16	30PCS
JDL206-20W	20W	Ø66x91	Trim	2300lm	0.35	20PCS
JDL206-25W	25W	Ø87x105	Trim	2700lm	0.56	20PCS
JDL206-35W	35W	Ø102x104	Trim	3450lm	0.74	20PCS
JDL206-3A	Trim	Ø100x40x83	Ø85-90	Trim	0.17	60PCS
JDL206-3B	Trim	Ø100x53x83	Ø85-90	Trim	0.16	60PCS
JDL206-4A	Trim	Ø140x53x115	Ø120-130	Trim	0.29	40PCS
JDL206-4B	Trim	Ø140x71x115	Ø120-130	Trim	0.32	40PCS
JDL206-5A	Trim	Ø160x71x140	Ø145-150	Trim	0.41	20PCS
JDL206-5B	Trim	Ø160x84.5x140	Ø145-150	Trim	0.40	20PCS

CCT — 2700K 3000K 4000K 5000K

Trim — White Black

## JDL206 DIY module



## JCL103 Downlight

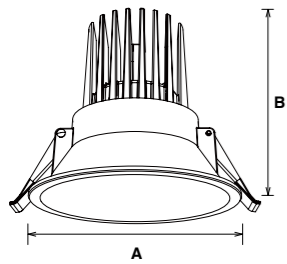

JCL103 fixed downlight adopts brand CREE COB, reflector and ADC12 aluminum heatsink. Deep cone design creates low UGR. External driver is exchangeable through quick connector among non-dimmable driver, Triac dimmable, 0-10V and DALI dimmable drivers.

- ▶
- ▶
- ▶
- ▶

Code	Watt	Size(AxBmm)	Cut-out(mm)	Lumen(±5%)	N.W/pc(kgs)	Q'ty/CTN
JCL103-3-12W	12W	Ø100x90.6	Ø90-95	1010lm	0.40	24PCS
JCL103-3-12W-D	12W	Ø100x90.6	Ø90-95	980lm	0.40	24PCS

CCT  3000K  4000K  5000K  5700K

Trim  White  Black



## JCL103B Downlight

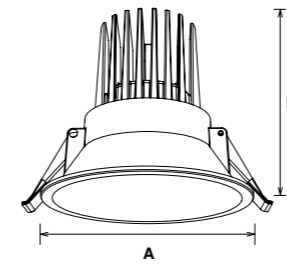

JCL103B fixed downlight adopts high efficiency SMD LED chips, PMMA lens and ADC12 aluminum heatsink. Deep cone design creates low UGR. External driver is exchangeable through quick connector among non-dimmable driver, Triac dimmable, 0-10V and DALI dimmable drivers.

- ▶
- ▶
- ▶
- ▶

Code	Watt	Size(AxBmm)	Cut-out(mm)	Lumen(±5%)	N.W/pc(kgs)	Q'ty/CTN
JCL103B-2.5-8W	8W	Ø80x100	Ø70-75	720lm	0.38	24PCS
JCL103B-2.5-10W	10W	Ø80x100	Ø70-75	900lm	0.38	24PCS
JCL103B-3-10W	10W	Ø100x90.6	Ø90-95	960lm	0.40	24PCS
JCL103B-3-12W	12W	Ø100x90.6	Ø90-95	1140lm	0.40	24PCS

CCT  3000K  4000K  5000K  5700K

Trim  White  Black



# JDL201 Downlight

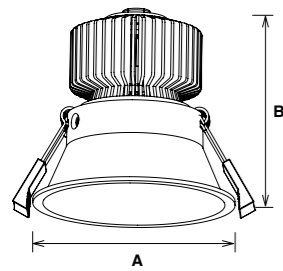

JDL201 downlight adopts brand CITIZEN COB, reflector and AL6063 aluminum heatsink. Deep cone design creates low UGR<19. Fixed or rotatable optional. External driver is exchangeable through quick connector among non-dimmable driver, Triac dimmable, 0-10V and DALI dimmable drivers.

- ▶ 36° IP40 UGR<19
  - ▶ DIM DALI 0-10V
  - ▶ AC 200-240V PF≥0.9 CRI≥80 CRI≥90 CRI≥97
  - ▶
- 

Code	Watt	Size(AxBmm)	Cut-out(mm)	Lumen(±5%)	N.W/pc(kgs)	Q'ty/CTN
JDL201A-2.5-10W	10W	Ø80x87	Ø75	910lm	0.26	36PCS
JDL201B-2.5-10W	10W	Ø85x81	Ø75	910lm	0.27	36PCS
JDL201-3-13W	13W	Ø100x94	Ø90	1170lm	0.32	24PCS
JDL201-3.5-13W	13W	Ø105x145	Ø100	1100lm	0.38	24PCS

CCT ——— 2700K 3000K 4000K 5000K

Trim ——— White Black

# ANTI GLARE DESIGN rotcefler peed htiw ( UGR<19 )





# JCL117 & JCL118 Downlight

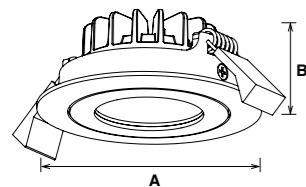

JCL117 & JCL118 slimline rotatable downlight adopts curve/ flat frame and exchangeable module, using brand CITIZEN COB, reflector (A) / lens (B) and ADC12 aluminum heatsink. External driver is exchangeable through quick connector between non-dimmable driver and Triac dimmable driver. Loop in/ loop out terminal makes convenient installation.

- ▶ 24° 36° 45° 60°
- ▶ IP54
- ▶ DIM DALI 0-10V DIM TO WARM
- ▶ AC 200-240V PF≥0.9 CRI≥80 CRI≥90 CRI≥97
- ▶ RoHS CE

Code	Watt	Size(AxBmm)	Cut-out(mm)	Lumen(±5%)	N.W/pc(kgs)	Q'ty/CTN
JCL117A-2.5-6W	6W	Ø80x35	Ø68-75	530lm	0.19	48PCS
JCL117B-2.5-6W	6W	Ø80x35	Ø68-75	500lm	0.19	48PCS
JCL117A-3-6W	6W	Ø95x49	Ø82-88	570lm	0.25	36PCS
JCL117B-3-6W	6W	Ø95x49	Ø82-88	530lm	0.28	36PCS
JCL117A-3-8W	8W	Ø95x49	Ø82-88	785lm	0.25	36PCS
JCL117B-3-8W	8W	Ø95x49	Ø82-88	765lm	0.28	36PCS
JCL117A-3-10W	10W	Ø95x49	Ø82-88	1000lm	0.25	36PCS
JCL117B-3-10W	10W	Ø95x49	Ø82-88	970lm	0.28	36PCS
JCL118A-2.5-6W	6W	Ø80x33	Ø68-75	530lm	0.19	48PCS
JCL118B-2.5-6W	6W	Ø80x33	Ø68-75	500lm	0.19	48PCS
JCL118A-3-6W	6W	Ø95x44	Ø82-88	570lm	0.25	36PCS
JCL118B-3-6W	6W	Ø95x44	Ø82-88	530lm	0.27	36PCS
JCL118A-3-8W	8W	Ø95x44	Ø82-88	785lm	0.25	36PCS
JCL118B-3-8W	8W	Ø95x44	Ø82-88	765lm	0.27	36PCS
JCL118A-3-10W	10W	Ø95x44	Ø82-88	1000lm	0.25	36PCS
JCL118B-3-10W	10W	Ø95x44	Ø82-88	970lm	0.27	36PCS

CCT — 2700K 3000K 4000K 5000K Trim — White Black Silver Nickel Brushed

## JCL117 & JCL118 DIY module

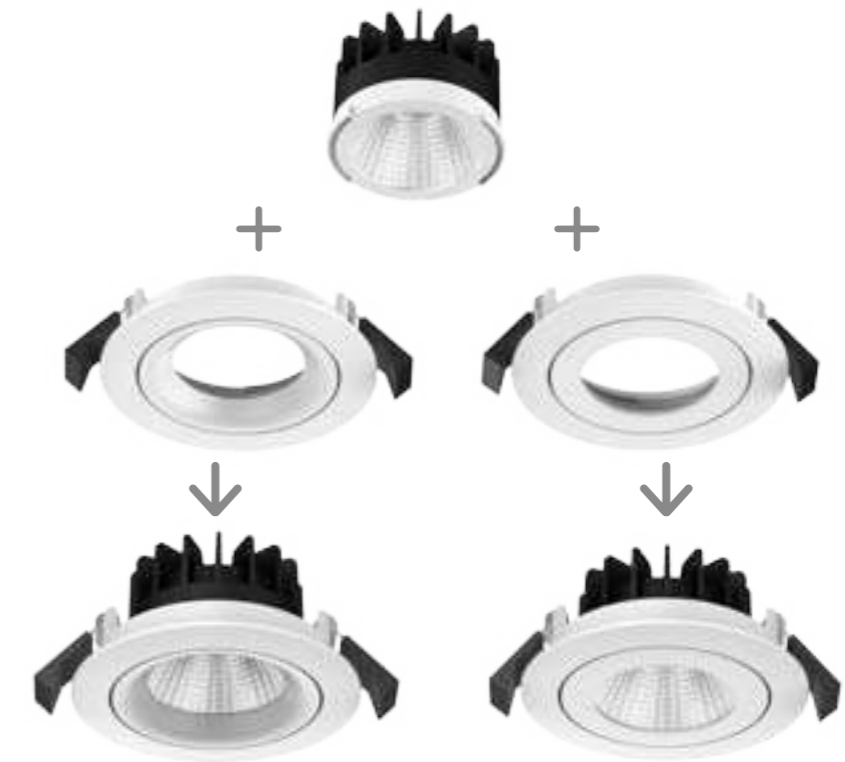

JCL117A

JCL118A



JCL117B

JCL118B

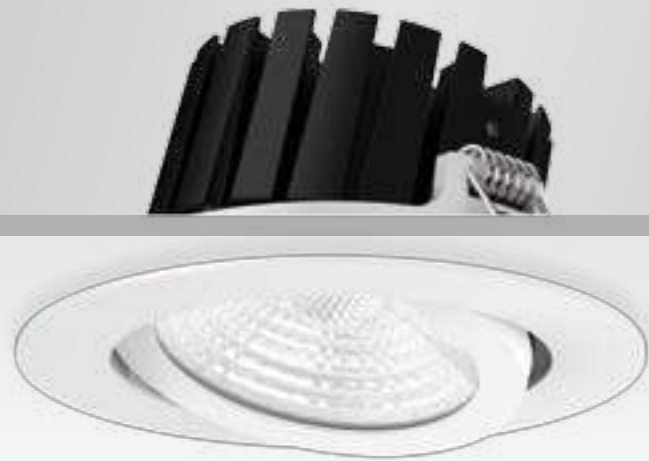

## JCL102 Downlight

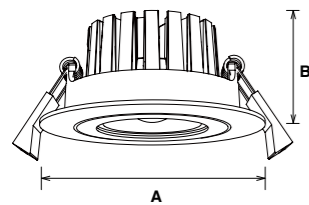

JCL102 slimline IP65 rotatable downlight adopts brand CREE COB, anti-glare lens and ADC12 aluminum heatsink. External driver is exchangeable through quick connector between non-dimmable driver and Triac dimmable driver.

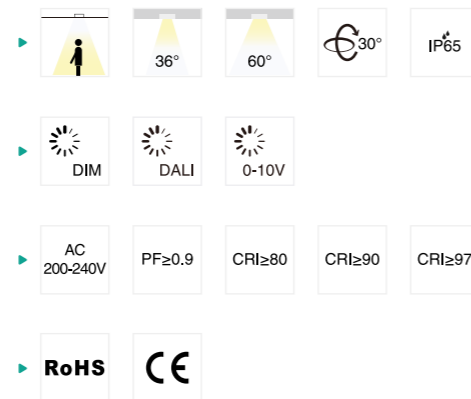

Code	Watt	Size(AxBmm)	Cut-out(mm)	Lumen(±5%)	N.W/pc(kgs)	Q'ty/CTN
JCL102A-2.5-5W	5W	Ø80x30	Ø68-72	530lm	0.24	50PCS
JCL102A-2.5-8W	8W	Ø80x30	Ø68-72	815lm	0.24	50PCS
JCL102B-2.5-10W	10W	Ø90x39.3	Ø75-80	1000lm	0.25	50PCS
JCL102-3-10W	10W	Ø110x49.5	Ø90-95	1000lm	0.40	30PCS
JCL102-3-13W	13W	Ø110x49.5	Ø90-95	1350lm	0.40	30PCS

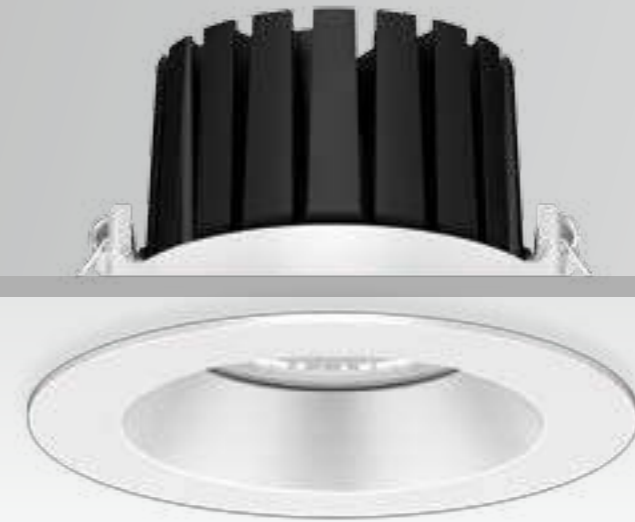

## JDL103 Downlight

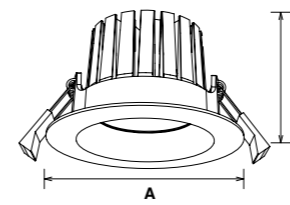

JDL103 slimline IP65 fixed downlight adopts brand CREE COB, anti-glare lens and ADC12 aluminum heatsink. External driver is exchangeable through quick connector between non-dimmable driver and Triac dimmable driver.

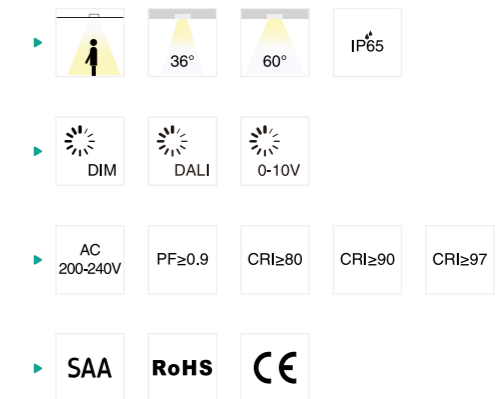

Code	Watt	Size(AxBmm)	Cut-out(mm)	Lumen(±5%)	N.W/pc(kgs)	Q'ty/CTN
JDL103A-2.5-5W	5W	Ø80x40	Ø68-72	530lm	0.18	50PCS
JDL103A-2.5-8W	8W	Ø80x40	Ø68-72	815lm	0.18	50PCS
JDL103B-2.5-10W	10W	Ø90x49.4	Ø75-80	1000lm	0.27	50PCS
JDL103-3-10W	10W	Ø110x64.3	Ø90-95	1000lm	0.45	30PCS
JDL103-3-13W	13W	Ø110x64.3	Ø90-95	1350lm	0.45	30PCS



# JCL104 Downlight

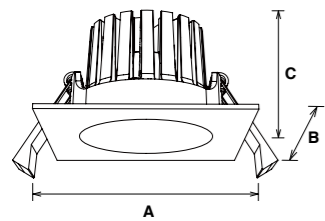

JCL104 square slimline IP65 rotatable downlight adopts brand CREE COB, anti-glare lens and ADC12 aluminum heatsink. External driver is exchangeable through quick connector between non-dimmable driver and Triac dimmable driver.

- ▶ 36° 60° 30° IP65
- ▶ DIM DALI 0-10V
- ▶ AC 200-240V PF $\geq$ 0.9 CRI $\geq$ 80 CRI $\geq$ 90 CRI $\geq$ 97
- ▶ SAA RoHS CE

Code	Watt	Size(AxBxCmm)	Cut-out(mm)	Lumen( $\pm$ 5%)	N.W/pc(kgs)	Q'ty/CTN
JCL104A-2.5-5W	5W	80x80x30	Ø68-72	530lm	0.22	50PCS
JCL104A-2.5-8W	8W	80x80x30	Ø68-72	815lm	0.22	50PCS
JCL104B-2.5-10W	10W	90x90x39	Ø75-80	1000lm	0.26	50PCS
JCL104-3-10W	10W	110x110x50	Ø90-95	1000lm	0.35	30PCS
JCL104-3-13W	13W	110x110x50	Ø90-95	1350lm	0.35	30PCS

CCT — 2700K 3000K 4000K 5000K Trim — White Black Silver Nickel Brushed

# JDL104 Downlight

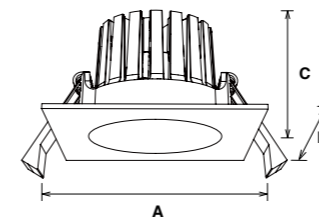

JDL104 square slimline IP65 fixed downlight adopts brand CREE COB, anti-glare lens and ADC12 aluminum heatsink. External driver is exchangeable through quick connector between non-dimmable driver and Triac dimmable driver.

- ▶ 36° 60° IP65
- ▶ DIM DALI 0-10V
- ▶ AC 200-240V PF $\geq$ 0.9 CRI $\geq$ 80 CRI $\geq$ 90 CRI $\geq$ 97
- ▶ SAA RoHS CE

Code	Watt	Size(AxBxCmm)	Cut-out(mm)	Lumen( $\pm$ 5%)	N.W/pc(kgs)	Q'ty/CTN
JDL104A-2.5-5W	5W	80x80x40	Ø68-72	530lm	0.22	50PCS
JDL104A-2.5-8W	8W	80x80x40	Ø68-72	815lm	0.22	50PCS
JDL104B-2.5-10W	10W	90x90x49	Ø75-80	1000lm	0.28	50PCS
JDL104-3-10W	10W	110x110x64	Ø90-95	1000lm	0.39	30PCS
JDL104-3-13W	13W	110x110x64	Ø90-95	1350lm	0.39	30PCS

CCT — 2700K 3000K 4000K 5000K Trim — White Black Silver Nickel Brushed



## JDL63 Downlight

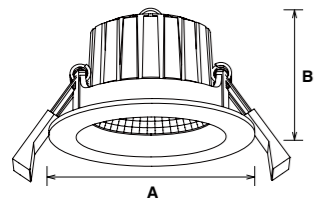

JDL63 Mini downlight is with standard cutout size of 70mm. 24°/36°/60° beam angle provided, CRI80/90/97 optional, it is applicable for various lighting effect. Waterproof structural design, IP54 protection grade, ideally for damp locations.

- ▶ 24° 36° 60° IP54
- ▶ DIM DALI 0-10V DIM TO WARM
- ▶ AC 200-240V PF≥0.9 CRI≥80 CRI≥90 CRI≥97
- ▶ SAA RoHS CE

Code	Watt	Size(AxBmm)	Cut-out(mm)	Lumen(±5%)	N.W/pc(kgs)	Q'ty/CTN
JDL63-2.5-5W	5W	Ø80x55	Ø68-74	450lm	0.28	48PCS
JDL63-2.5-8W	8W	Ø80x55	Ø68-74	590lm	0.28	48PCS
JDL63-2.5-8W-P	8W	Ø80x55	Ø68-74	400lm	0.28	48PCS

## JDL64 Downlight

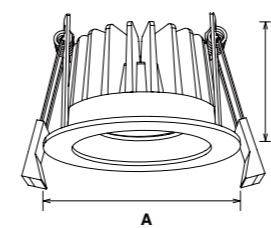

JDL64 downlight adopts super high lumen COB and excellent light transmittance prismatic lens. 36°/60° beam angle are available. Cutout 70-75mm, an ideal replacement for traditional lamps.

- ▶ 36° 60° IP40
- ▶ DIM DALI 0-10V
- ▶ AC 200-240V PF≥0.9 CRI≥80 CRI≥90 CRI≥97
- ▶ SAA RoHS CE

Code	Watt	Size(AxBmm)	Cut-out(mm)	Lumen(±5%)	N.W/pc(kgs)	Q'ty/CTN
JDL64-2.5-10W	10W	Ø82x58	Ø70-75	1010lm	0.25	48PCS



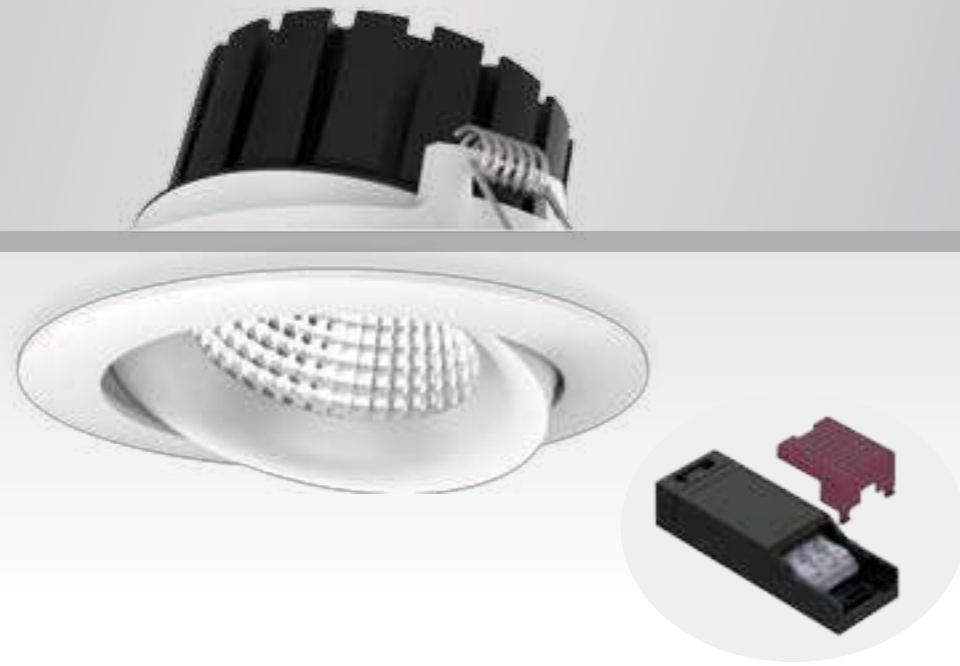

## JCL76 Downlight

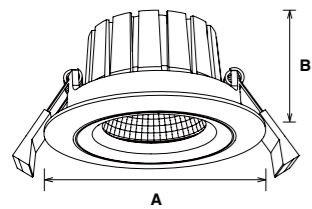

JCL76 Mini down light JCL76 is specially designed for European market with standard cutout size of 83mm. 15°/24°/36°/60° beam angle are provided. Combined of COB LED and PC reflector. 25 degree flexible rotary head makes installation easier and better. CRI80/90/97 optional, dim to warm is available.

- ▶ 15° 24° 36° 60°
- ▶ 25° IP54
- ▶ DIM DALI 0-10V DIM TO WARM
- ▶ AC 200-240V PF≥0.9 CRI≥80 CRI≥90 CRI≥97
- ▶ RoHS CE

Code	Watt	Size(AxBmm)	Cut-out(mm)	Lumen(±5%)	N.W/pc(kgs)	Q'ty/CTN
JCL76-3-8W	8W	Ø95x55	Ø82-88	570lm	0.34	48PCS
JCL76-3-10W	10W	Ø95x55	Ø82-88	770lm	0.34	48PCS
JCL76-3-10W-P	10W	Ø95x55	Ø82-88	450lm	0.34	48PCS

CCT — 2700K 3000K 4000K 5000K Trim — White Black Silver Nickel Brushed



## JCL78 Downlight

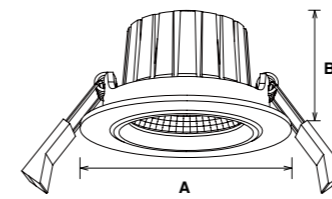

JCL78 Mini down light JCL78 with 24°/36°/60° beam angle is applicable for various lighting effects. With IP54 waterproof design, it is the ideal for damp locations. 25 degree flexible rotary head makes installation easier and better. CRI80/90/97 optional, dim to warm is available.

- ▶ 24° 36° 60° 25° IP54
- ▶ DIM DALI 0-10V DIM TO WARM
- ▶ AC 200-240V PF≥0.9 CRI≥80 CRI≥90 CRI≥97
- ▶ RoHS CE

Code	Watt	Size(AxBmm)	Cut-out(mm)	Lumen(±5%)	N.W/pc(kgs)	Q'ty/CTN
JCL78-2.5-5W	5W	Ø80x50	Ø68-74	450lm	0.27	48PCS
JCL78-2.5-8W	8W	Ø80x50	Ø68-74	600lm	0.27	48PCS
JCL78-2.5-8W-P	8W	Ø80x50	Ø68-74	400lm	0.27	48PCS

CCT — 2700K 3000K 4000K 5000K Trim — White Black Silver Nickel Brushed



# JCL77 Downlight

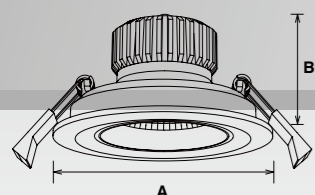

Patent mini down light JCL77 is specially designed for European market. It adopts high-reflectivity PC reflector; adjustable lighting direction provides all possible lighting effects, 360 degree rotates horizontally and 25 degree rotates vertically, multiple beam angle options: 15°/24°/36°/60°.

- ▶ 15° 24° 36° 60°
- ▶ 360° 25° IP40
- ▶ DIM DALI 0-10V DIM TO WARM
- ▶ AC 200-240V PF $\geq$ 0.9 CRI $\geq$ 80 CRI $\geq$ 90 CRI $\geq$ 97
- ▶ RoHS CE

Code	Watt	Size(AxBmm)	Cut-out(mm)	Lumen(±5%)	N.W/pc(kgs)	Q'ty/CTN
JCL77-3-10W	10W	Ø100x58	Ø85-90	770lm	0.34	48PCS
JCL77-3-10W-P	10W	Ø100x58	Ø85-90	450lm	0.34	48PCS

CCT — 2700K 3000K 4000K 5000K

Ring — White Black



# JCL79 Downlight

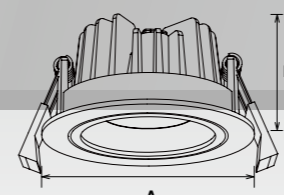

Mini down light JCL79 achieves 100lm/W high efficiency with super high lumen COB and excellent light transmittance prismatic lens. It has 22° vertically adjustable lighting directions. External driver makes easier maintenance.

- ▶ 36° 60° 22° IP40
- ▶ DIM DALI 0-10V
- ▶ AC 200-240V PF $\geq$ 0.85 PF $\geq$ 0.9 CRI $\geq$ 80 CRI $\geq$ 90 CRI $\geq$ 97
- ▶ SAA RoHS CE

Code	Watt	Size(AxBmm)	Cut-out(mm)	Lumen(±5%)	N.W/pc(kgs)	Q'ty/CTN
JCL79-2.5-10W	10W	Ø90x46	Ø84	1010lm	0.26	48PCS

CCT — 2700K 3000K 4000K 5000K

Trim — White Black



## JCL79A/B Downlight

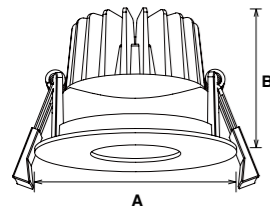

This Mini down light achieves 100lm/W high efficiency with super high lumen COB and excellent light transmittance prismatic lens. It has adjustable head for different lighting directions. External driver makes easier maintenance.

- ▶ 36° 5° IP40
- ▶ DIM DALI 0-10V
- ▶ AC 200-240V PF≥0.5 PF≥0.9 CRI≥80 CRI≥90 CRI≥97
- ▶ SAA RoHS CE

Code	Watt	Size(AxBmm)	Cut-out(mm)	Lumen(±5%)	N.W/pc(kgs)	Q'ty/CTN
JCL79A-2.5-10W	10W	Ø91.5x61	Ø84	800lm	0.26	48PCS
JCL79B-2.5-10W	10W	Ø91.5x61	Ø84	800lm	0.26	48PCS

CCT — 2700K — 3000K — 4000K — 5000K

Trim — White Black



## JCL79C Downlight

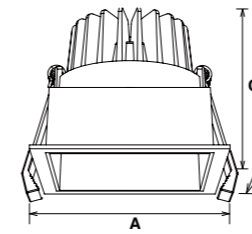

This Mini down light achieves 100lm/W high efficiency with super high lumen COB and excellent light transmittance prismatic lens. It has 22° vertically adjustable lighting directions. External driver makes easier maintenance.

- ▶ 36° 60° 22° IP40
- ▶ DIM DALI 0-10V
- ▶ AC 200-240V PF≥0.5 PF≥0.9 CRI≥80 CRI≥90 CRI≥97
- ▶ SAA RoHS CE

Code	Watt	Size(AxBxCmm)	Cut-out(mm)	Lumen(±5%)	N.W/pc(kgs)	Q'ty/CTN
JCL79C-2.5-10W	10W	90x90x76	84x84	1020lm	0.30	48PCS

CCT — 2700K — 3000K — 4000K — 5000K

Trim — White Black



## JDL322B Downlight

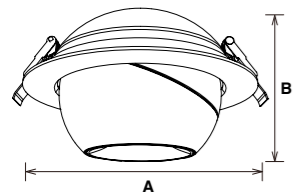

JDL322B adopts high lumen COB chip. The type B is recessed installation. AL6063 aluminum lamp body provides excellent heat dissipation. Beam angle 36 and 60 degree adjustable. Triac and DALI dimmable is available.

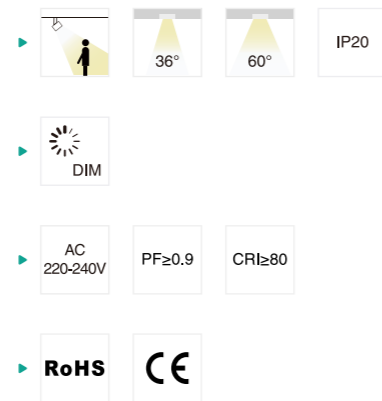

Code	Watt	Size(AxBmm)	Cut-out(mm)	Lumen(±5%)	N.W/pc(kgs)	Q'ty/CTN
JDL322B-10W	10W	Ø172x100	Ø145-155	900lm	1.10	12PCS
JDL322B-15W	15W	Ø172x100	Ø145-155	1400lm	1.10	12PCS

CCT — 2700K — 3000K — 4000K — 5000K

Finish —  White  Black

## JDL123 Downlight

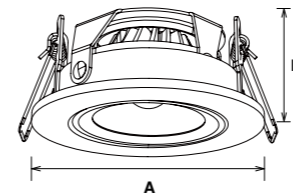

Mini gyro downlight JDL123, adopts high lumen COB LED, high energy efficacy and high CRI and tight focus. DL123 downlight is ideally suitable for a variety of applications. With the adjustable and rotatable luminaire, it perfectly meets the demands of different lighting angle.

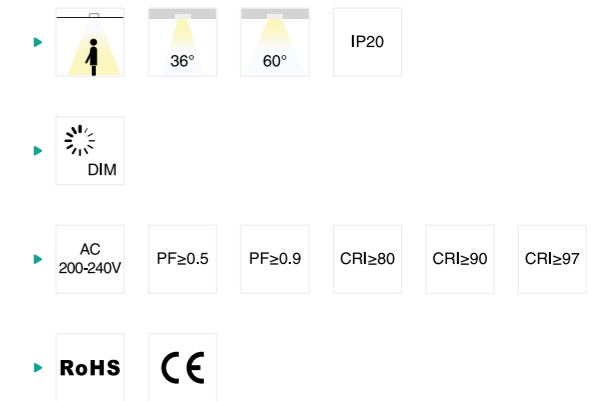

Code	Watt	Size(AxBmm)	Cut-out(mm)	Lumen(±5%)	N.W/pc(kgs)	Q'ty/CTN
JDL123-2.5-6W	6W	Ø80x37	Ø72-75	615lm	0.21	40PCS

CCT — 2700K — 3000K — 4000K — 5000K

Trim —  White  Black



## JDL124 Downlight

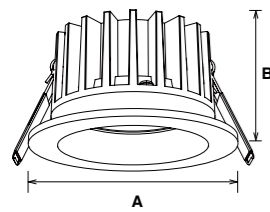

JDL124 down light with smart optical design combines COB LED and PC reflector. It creates the most comfortable lighting environment. With waterproof IP65 structural design, it is the ideal for damp locations. Aluminum profile provides excellent thermal dissipation.

- ▶ 36°
- ▶ IP65
- ▶ IP20
- ▶ DIM
- ▶ AC 200-240V
- ▶ PF ≥ 0.5
- ▶ PF ≥ 0.9
- ▶ CRI ≥ 80
- ▶ RoHS
- ▶ CE

Code	Watt	Size(AxBmm)	Cut-out(mm)	Lumen(±5%)	N.W/pc(kgs)	Q'ty/CTN
JDL124-2.5-7W	7W	Ø90x50	Ø74-80	600lm	0.25	50PCS

CCT — 2700K — 3000K — 4000K — 5000K

Trim — White Black



## JDL88 Downlight

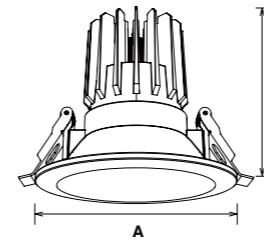

JDL88 down light is unique designed with deep reflector. ADC12 aluminum profile provides excellent thermal dissipation. Isolated driver solution both in dimmable and non-dimmable version achieved a great dimming compatibility with worldwide brand dimmers.

- ▶ 24°
- ▶ 60°
- ▶ IP20
- ▶ DIM
- ▶ DALI
- ▶ 0-10V
- ▶ AC 200-240V
- ▶ PF ≥ 0.9
- ▶ CRI ≥ 80
- ▶ CRI ≥ 90
- ▶ CRI ≥ 97
- ▶ SAA
- ▶ RoHS
- ▶ CE

Code	Watt	Size(AxBmm)	Cut-out(mm)	Lumen(±5%)	N.W/pc(kgs)	Q'ty/CTN
JDL88-2.5-10W	10W	Ø85x89	Ø68-75	860lm	0.27	24PCS
JDL88-2.5-13W	13W	Ø85x89	Ø68-75	1190lm	0.27	24PCS
JDL88-3-13W	13W	Ø110x98	Ø90-95	1190lm	0.35	24PCS

CCT — 2700K — 3000K — 4000K — 5000K

Trim — White Black



## JDL202 Cabinet light

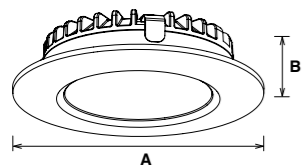

JDL202 LED under cabinet light with ADC12 aluminum light body, providing good heat dissipation. 70 degree beam angle with lens. Adopting 12V constant voltage driver, 3-way and 6-way distributor for options.

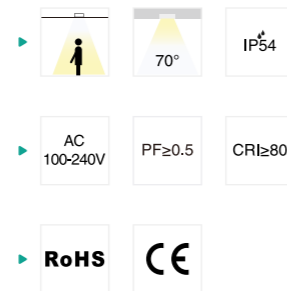

Code	Watt	Size(AxBmm)	Cut-out(mm)	Lumen(±5%)	N.W/pc(kgs)	Q'ty/CTN
JDL202-3.5W	3.5W	Ø70x17	Ø58	300lm	0.08*3	30*3PCS
driver with 3-way distributor	/	/	/	/	0.13	90PCS
driver with 6-way distributor	/	/	/	/	0.14	90PCS

CCT — 3000K 4000K 5000K 5700K

Finish — White Black

## JDL278 Cabinet light

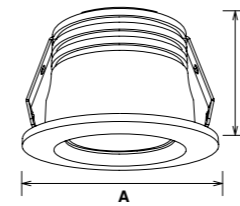

JDL278 minimises and recessed spot design makes the luminaire glare free, adopting high quality brand COB as symmetric lighting, flicker free external driver. CRI>80 or CRI>90 for options. AL6063 die-casting lamp body provides great heat dissipation. Several beam angles available, such as 15°/24°/32°/36°. Attractive as a decor light recessed into window nooks and furniture.

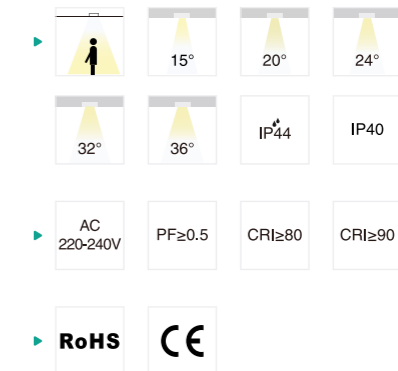

Code	Watt	Size(AxBmm)	Cut-out(mm)	Lumen(±5%)	N.W/pc(kgs)	Q'ty/CTN
JDL278-1-1.5W	1.5W	Ø30x24	Ø25	110lm	0.04	60PCS
JDL278-1.4-3W	3W	Ø40x24	Ø35	210lm	0.06	60PCS

CCT — 2700K 3000K 4000K

Trim — White Black



## JDL301 Cabinet light

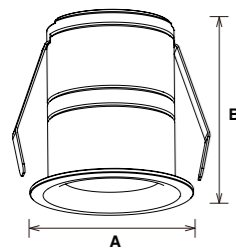

JDL301 is LED mini downlight design, which is suitable applied for specialty store, display cabinet, jewelry cabinet, kitchen cabinet, hotel, and home. Low glare UGR<19 provide high visual experience.



Code	Watt	Size(AxBmm)	Cut-out(mm)	Lumen(±5%)	N.W/pc(kgs)	Q'ty/CTN
JDL301-30-3W-D	3W	Ø35x46	Ø30	170lm	0.10	48PCS
JDL301-40-5W-D	5W	Ø45x49	Ø40	350lm	0.13	48PCS
JDL301-50-7W-D	7W	Ø55x53	Ø50	490lm	0.18	48PCS

CCT — 2700K — 3000K — 4000K — 5000K

Trim — White Black



## JCL138 Cabinet light

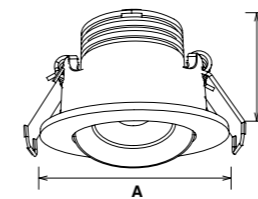

JCL138 minimises and recessed spot design makes the luminaire glare free, With djustable head version (Titling angle is ±20°). Flicker free external driver, CRI>80 or CRI>90 for options. AL6063 die-casting lamp body provides great heat dissipation. Several beam angles available, such as 15°/20°/24°/32°. Attractive as a decor light recessed into window nooks and furniture.



Code	Watt	Size(AxBmm)	Cut-out(mm)	Lumen(±5%)	N.W/pc(kgs)	Q'ty/CTN
JCL138-1.8-3W	3W	Ø50x30	Ø45	210lm	0.09	60PCS

CCT — 2700K — 3000K — 4000K

Trim — White Black



## JCL140 Downlight

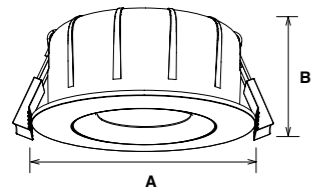

This downlight is a gyro design, it has a rear cover which is suitable for covering with insulation material directly. Adopt high lumen COB light source, ADC12 aluminum housing provides a great heat dissipation. 15°/24°/36°/60° beam angle provided, available for Dim to warm 2000-3000K. Lamp with female plug, driver with male plug, which make an easier installation. Tilt 23° in all directions(360°).

- ▶ 15° 24° 36° 60°
- ▶ 23° IP54
- ▶ DIM DALI 0-10V DIM TO WARM
- ▶ AC 200-240V PF ≥ 0.85 CRI ≥ 80 CRI ≥ 90 CRI ≥ 97
- ▶ RoHS CE

Code	Watt	Size(AxBmm)	Cut-out(mm)	Lumen(±5%)	N.W/pc(kgs)	Q'ty/CTN
JCL140-2.5-8W	8W	Ø96x44	Ø83	850lm	0.18	40PCS

CCT — 2700K 3000K 4000K 5000K Trim — White Black Silver Nickel Brushed



## JCL128 Downlight

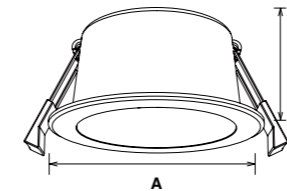

JCL128 LED downlight is gyro design which is suitable for covering with insulation material directly. It adopts high lumen COB light source, ADC12 aluminum housing provides a great heat dissipation. Different lighting angle with tilt 30° in all directions(360°) and Dim-to-Warm version (2000K~3000K) are available.

- ▶ 12° 24° 36° 60° IP20
- ▶ DIM DALI 0-10V DIM TO WARM
- ▶ AC 200-240V PF ≥ 0.85 CRI ≥ 80 CRI ≥ 90 CRI ≥ 97
- ▶ RoHS CE

Code	Watt	Size(AxBmm)	Cut-out(mm)	Lumen(±5%)	N.W/pc(kgs)	Q'ty/CTN
JCL128-2.5-8W-D	8W	Ø95x50	Ø83-86	864lm	0.30	40PCS
JCL128-2.5-8W-DW	8W	Ø95x50	Ø83-86	445lm	0.30	40PCS

CCT — 2700K 3000K 4000K 5000K Trim — White Black Silver Nickel Brushed





## JDL263 Downlight

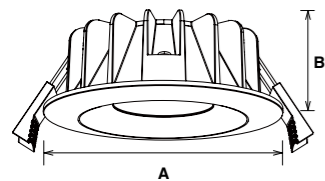

This is a fixed mini downlight, suitable for covering with insulation material directly. Adopt high lumen COB light source, ADC12 aluminum housing provides a great heat dissipation. 15°/24°/36°/60° beam angle provided, available for Dim to warm 2000-3000K. Lamp with female plug, driver with male plug, which makes an easier installation.

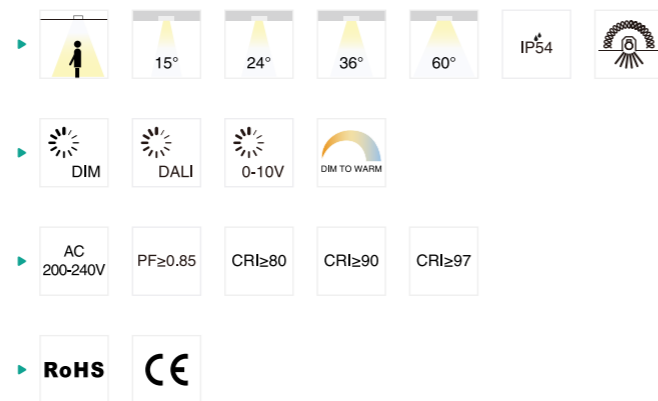

Code	Watt	Size(AxBmm)	Cut-out(mm)	Lumen(±5%)	N.W/pc(kgs)	Q'ty/CTN
JDL263-2.5-8W	8W	Ø95x35	Ø83	850lm	0.17	40PCS

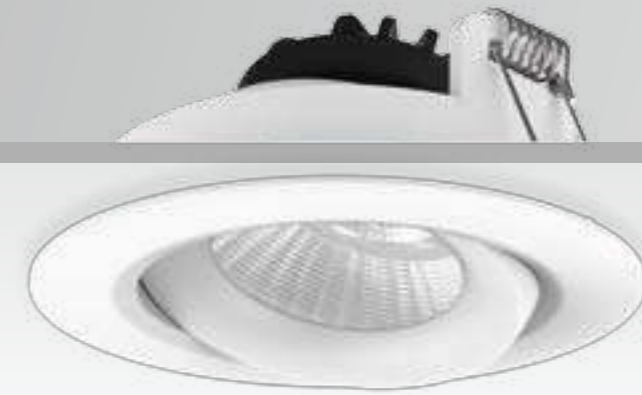
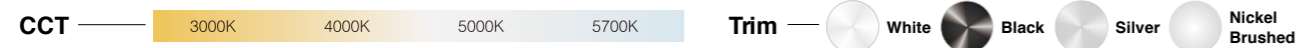

## JCL130 Downlight

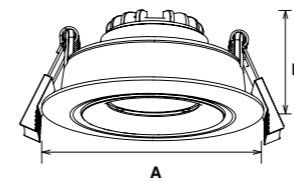

This downlight is a gyro design. Adopt high lumen COB light source, ADC12 aluminum housing provides a great heat dissipation. The luminaire is tilted 23° in all directions (360°), perfectly meet the demands of different lighting angle. Also available as Dim-to-Warm version (2000K~3000K).

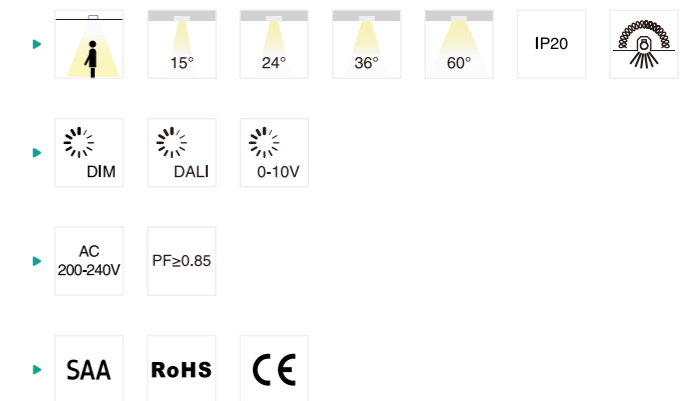

Code	Watt	Size(AxBmm)	Cut-out(mm)	Lumen(±5%)	N.W/pc(kgs)	Q'ty/CTN
JCL130-2.5-8W-D	8W	Ø95x45mm	Ø83-86	814lm	0.28	40PCS
JCL130-2.5-8W-DW	8W	Ø95x45mm	Ø83-86	497lm	0.28	40PCS

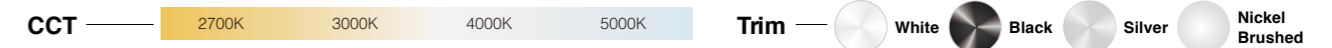



# JRD01 Downlight

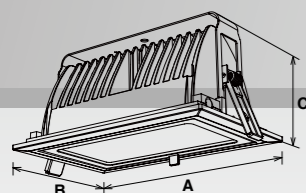

JRD01 rectangular downlight is unique designed with COB high power LED chip. IP65 waterproof can be used in wider applications, especial for damp location. AL6063 Aluminum profile provides excellent thermal dissipation. Isolated external driver solution achieves stable working performance.

- ▶ 120° 45°
- ▶ DIM DALI 0-10V
- ▶ AC 100-240V PF≥0.9 CRI≥80
- ▶ SAA RoHS CE

Code	Watt	Size(AxBxCmm)	Cut-out(mm)	Lumen(±5%)	N.W/pc(kgs)	Q'ty/CTN
JRD01-35W	35W	235x145x117.4	220x130	3050lm	2.40	6PCS
JRD01-45W	45W	235x145x117.4	220x130	3850lm	2.40	6PCS

# JRD01-B Downlight

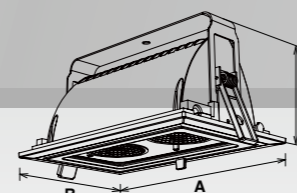

JRD01-B rectangular downlight is unique designed with 2 COB chips. IP65 waterproof can be used in wider applications, especial for damp location. AL6063 Aluminum profile provides excellent thermal dissipation. Isolated external driver solution achieves stable working performance.

- ▶ 45° 45°
- ▶ DIM DALI 0-10V
- ▶ AC 100-240V PF≥0.9 CRI≥80
- ▶ RoHS CE

Code	Watt	Size(AxBxCmm)	Cut-out(mm)	Lumen(±5%)	N.W/pc(kgs)	Q'ty/CTN
JRD01-B-35W	35W	235x145x117.4	220x130	2970lm	2.40	6PCS
JRD01-B-45W	45W	235x145x117.4	220x130	3900lm	2.40	6PCS

CCT — 2700K 3000K 4000K 5000K

Finish — White Black

CCT — 2700K 3000K 4000K 5000K

Finish — White Black



## JRD01-C Downlight

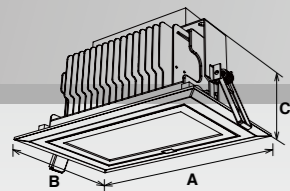

JRD01-C SMD Rectangular downlight achieves high lumen output, 90° wide beam angle. AL6063 Aluminum profile provides excellent thermal dissipation. External driver solution achieves stable working performance and easy maintenance. Tilt head provides various lighting direction for different applications. It is widely used for different commercial lighting situation.

- ▶ 90°
- ▶ 65°
- ▶ IP20
- ▶ DIM
- ▶ DALI
- ▶ 0-10V
- ▶ SLIDE SWITCH 3 in 1
- ▶ AC 200-240V
- ▶ PF≥0.9
- ▶ CRI≥80
- ▶ SAA
- ▶ RoHS
- ▶ CE

Code	Watt	Size(AxBxCmm)	Cut-out(mm)	Lumen(±5%)	N.W/pc(kgs)	Q'ty/CTN
JRD01-C-40W	40W	246x156x115	225x130	3950lm	2.30	4PCS
JRD01-C-60W	60W	246x156x115	225x130	5450lm	2.30	4PCS

CCT ——— 3000K 4000K 5000K 5700K

Finish ——— White Black

## JRD07A&B Downlight

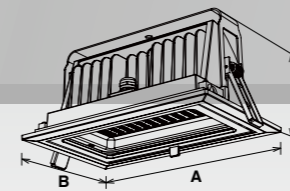

JRD07 LED is new commercial light series with external driver design. Type A is unique louver reflector design and type B woven glass design, both 2 types adopting high lumen SMD LED chip with uniform light output, ADC12 die casting aluminum provides an excellent thermal dissipation. IP65 waterproof and 70°vertically rotatable are available.

- ▶ 70°
- ▶ 110°
- ▶ 70°
- ▶ IP65
- ▶ IP20
- ▶ DIM
- ▶ DALI
- ▶ 0-10V
- ▶ SLIDE SWITCH 3 in 1
- ▶ AC 200-240V
- ▶ PF≥0.9
- ▶ CRI≥80
- ▶ RoHS
- ▶ CE



Code	Watt	Size(AxBxCmm)	Cut-out(mm)	Lumen(±5%)	N.W/pc(kgs)	Q'ty/CTN
JRD07A-32W	32W	235x145x117.4	220x130	3150lm	1.77	6PCS
JRD07A-42W	42W	235x145x117.4	220x130	3900lm	1.77	6PCS
JRD07B-32W	32W	235x145x117.4	220x130	4200lm	1.77	6PCS
JRD07B-42W	42W	235x145x117.4	220x130	5100lm	1.77	6PCS

CCT ——— 3000K 4000K 5000K 5700K

Finish ——— White Black



# JCL137 Downlight

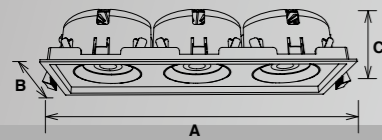

JCL137 LED commercial downlight series with external flicker free driver design, adopting brand Citizen COB, ADC12 aluminium lamp body provide great heat dissipation. Tilt 23° in all directions(360°) and IP54 are available. White/Black/Silver/Nickel brushed 4 kinds of surface colors for options.

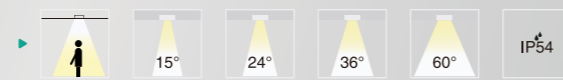

AC 220-240V PF≥0.9 CRI≥80 CRI≥90 CRI≥97



Code	Watt	Size(AxBxCmm)	Cut-out(mm)	Lumen(±5%)	N.W/pc(kgs)	Q'ty/CTN
JCL137-8W	8W	95x95x53	89x89	920lm	0.35	24PCS
JCL137-10W	10W	95x95x53	89x89	1100lm	0.35	24PCS
JCL137-14W	14W	175x95x53	69x89	1670lm	0.60	24PCS
JCL137-20W	20W	175x95x53	69x89	2230lm	0.60	24PCS
JCL137-24W	24W	255x95x53	249x89	2840lm	0.85	12PCS
JCL137-30W	30W	255x95x53	249x89	3320lm	0.85	12PCS

CCT — 2700K 3000K 4000K 5000K

Finish — White Black Silver Nickel Brushed

# JCL68 Downlight

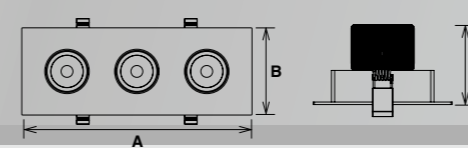

JCL68 square LED recessed commercial downlight adopts high-efficiency COB. It brings excellent lighting effect. Single head 10W, double heads 20W and triple heads 30W provide wider choices for you. Adjustable lighting direction offers various lighting orientation.

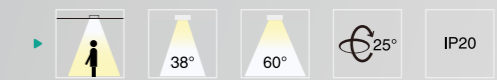

AC 200-240V PF≥0.9 CRI≥80 CRI≥90 CRI≥97

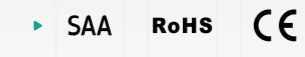

Code	Watt	Size(AxBxCmm)	Cut-out(mm)	Lumen(±5%)	N.W/pc(kgs)	Q'ty/CTN
JCL68-10W	10W	110x110x63	90-90	820lm	0.33	30PCS
JCL68-20W	20W	200x110x63	180-90	1650lm	0.60	20PCS
JCL68-30W	30W	290x110x63	270-90	2400lm	0.83	20PCS

CCT — 3000K 4000K 5000K 5700K

Finish — White Black

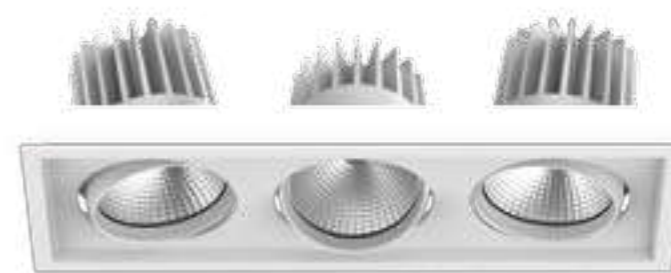

# JCL99 Downlight

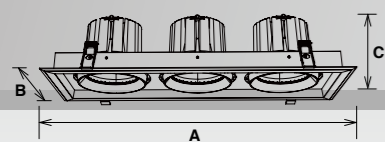

JCL99 downlight is a unique replaceable module design which makes an easier installation and maintenance. The drivers are separated and external for replacement easily. It is an ideal design for commercial lighting.

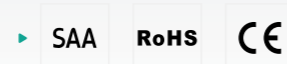
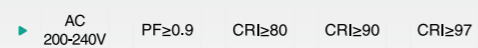
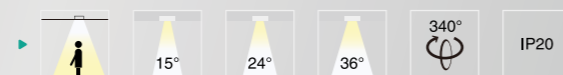

Code	Watt	Size(AxBxCmm)	Cut-out(mm)	Lumen(±5%)	N.W/pc(kgs)	Q'ty/CTN
JCL99-30W	30W	175x175x110	160-160	3100lm	1.25	12PCS
JCL99-60W	60W	330x175x110	310-160	5800lm	2.25	6PCS
JCL99-90W	90W	475x175x110	455-160	8800lm	3.20	6PCS

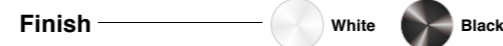

# JCL67 Downlight

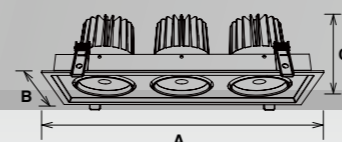

JCL67 square LED recessed commercial downlight adopts high-efficiency Citizen COB. It brings excellent lighting effect. Single head, double heads and triple heads provide wider choices for you. Adjustable lighting direction offers various lighting orientation.

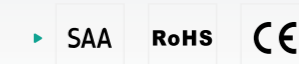
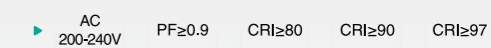
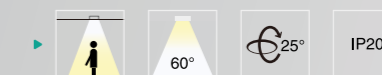

Code	Watt	Size(AxBxCmm)	Cut-out(mm)	Lumen(±5%)	N.W/pc(kgs)	Q'ty/CTN
JCL67-30W	30W	175x175x135	160-160	3210lm	1.30	12PCS
JCL67-60W	60W	330x175x135	310-160	6420lm	2.60	6PCS
JCL67-90W	90W	475x175x135	455-160	9630lm	3.60	4PCS

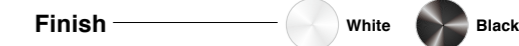



## JRD02 & JRD03 Downlight

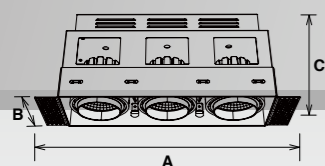

This frameless commercial downlight adopted brand CREE COB chip which offers a high lumen output. JRD02 JRD03 single head, double heads, triple heads provide a wider choice. Adjustable lighting direction offers various lighting orientation.

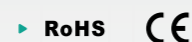
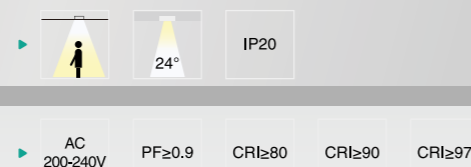

Code	Watt	Size(AxBxCmm)	Cut-out(mm)	Lumen(±5%)	N.W/pc(kgs)	Q'ty/CTN
JRD02-8W	8W	155.5x83.5x134	86-86	550lm	1.30	12PCS
JRD02-16W	16W	235.5x83.5x134	167-86	1250lm	1.90	6PCS
JRD02-24W	24W	315.5x83.5x134	247-86	1700lm	2.50	6PCS
JRD03-12W	12W	185x113x154	116-116	980lm	1.70	12PCS
JRD03-24W	24W	294x113x154	228-116	2040lm	2.50	6PCS
JRD03-36W	36W	404x113x154	338-116	2700lm	3.10	6PCS

CCT — 2700K — 3000K — 4000K — 5000K

Finish — White Black

## JRD04 & JRD05 Downlight



JRD04 & JRD05 with brand CREE COB high power LED chip. Single head, double heads and triple heads provide a wider choice. Adjustable lighting direction offers various lighting orientation.

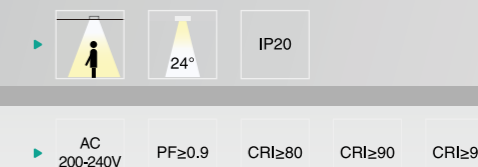

Code	Watt	Size(AxBxCmm)	Cut-out(mm)	Lumen(±5%)	N.W/pc(kgs)	Q'ty/CTN
JRD04-8W	8W	100x100x135	85-85	550lm	1.10	12PCS
JRD04-16W	16W	180x100x135	165-85	1250lm	1.80	6PCS
RD04-24W	24W	260x100x135	245-85	1700lm	2.40	6PCS
JRD05-12W	12W	130x130x155	115-115	980lm	1.60	12PCS
JRD05-24W	24W	239x130x155	224-115	2040lm	2.40	6PCS
JRD05-36W	36W	349x130x155	334-115	2700lm	3.00	6PCS

CCT — 2700K — 3000K — 4000K — 5000K

Finish — White Black



# JDL264 Downlight

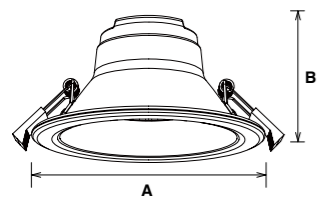

JDL264 LED downlight with anti-glare UGR<19 and external driver design. Adopting high lumen SMD light source 100lm/W, the scale PC shade and reflector make a uniform light output. AL1060 aluminum housing provides a great thermal management. Interchangeable CCT and IP54 in front are available.

- 60°
- IP54
- IP20
- UGR<19
- DIM
- DALI
- 0-10V
- SLIDE SWITCH 3 in 1
- AC 220-240V
- PF≥0.9
- CRI≥80
- SAA
- RoHS
- CE

Code	Watt	Size(AxBmm)	Cut-out(mm)	Lumen(±5%)	N.W/pc(kgs)	Q'ty/CTN
JDL264-3-10W	10W	Ø115x67mm	Ø90-95mm	950lm	0.21	30PCS
JDL264-3-13W	13W	Ø115x67mm	Ø90-95mm	1200lm	0.21	30PCS
JDL264-4-13W	13W	Ø145x73mm	Ø120-130mm	1200lm	0.26	24PCS
JDL264-4-18W	18W	Ø145x73mm	Ø120-130mm	1500lm	0.26	24PCS
JDL264-5-13W	13W	Ø170x86mm	Ø140-150mm	1350lm	0.31	24PCS
JDL264-5-18W	18W	Ø170x86mm	Ø140-150mm	1850lm	0.31	24PCS
JDL264-5-25W	25W	Ø170x86mm	Ø140-150mm	2650lm	0.31	24PCS
JDL264-6-18W	18W	Ø190x90mm	Ø160-170mm	1850lm	0.36	12PCS
JDL264-6-25W	25W	Ø190x90mm	Ø160-170mm	2650lm	0.36	12PCS
JDL264-6-30W	30W	Ø190x90mm	Ø160-170mm	3150lm	0.36	12PCS
JDL264-8-18W	18W	Ø235x100mm	Ø200-210mm	1850lm	0.52	12PCS
JDL264-8-25W	25W	Ø235x100mm	Ø200-210mm	2650lm	0.52	12PCS
JDL264-8-35W	35W	Ø235x100mm	Ø200-210mm	3600lm	0.52	12PCS

CCT — 3000K 4000K 5000K 5700K

Trim — White Black

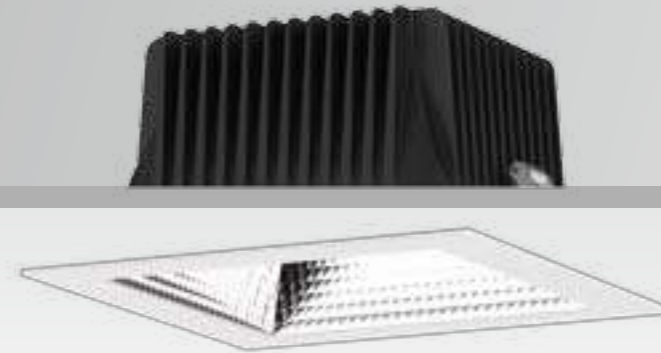

# JDL197 Downlight

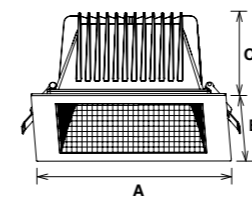

JDL197 SMD LED downlight is a square-trim LED downlight for accenting and comfortable lighting. Designed with a traditional deep reflector, the luminaire offers enhanced glare control(UGR<19). ADC12 Aluminum profile provides excellent thermal dissipation. IP44 waterproof in front for various application.

- 60°
- IP44
- UGR<19
- DIM
- DALI
- 0-10V
- TUNABLE WHITE
- SLIDE SWITCH 3 in 1
- AC 200-240V
- PF≥0.9
- CRI≥80
- RoHS
- CE

Code	Watt	Size(AxBxCmm)	Cut-out(mm)	Lumen(±5%)	N.W/pc(kgs)	Q'ty/CTN
JDL197-6-18W	18W	190x190x102	170x170	1760lm	1.02	8PCS
JDL197-6-22W	22W	190x190x102	170x170	2120lm	1.02	8PCS
JDL197-6-25W	25W	190x190x102	170x170	2420lm	1.02	8PCS
JDL197-6-32W	32W	190x190x102	170x170	3070lm	1.02	8PCS

CCT — 3000K 4000K 5000K 5700K

Trim — White Black



# JDL178 Downlight

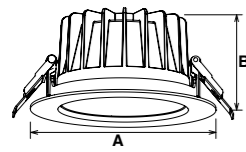

JDL178 downlight with deep-set reflector provides better glaring control(UGR<19).The luminaire with modular design offers a wide choice of beam angles, 24°/36°/60°for optional. Adopted COB CITIZEN brand to reach high efficiency 110lm/W and energy saving. The luminaire blends harmoniously into ceilings, making it ideal for commercial and residential applications.

### Reflector



- ▶
- ▶
- ▶
- ▶



Code	Watt	Size(AxBmm)	Cut-out(mm)	Lumen(±5%)	N.W/pc(kgs)	Q'ty/CTN
JDL178A-3-10W	10W	Ø95x54	Ø82-88	1120lm	0.23	36PCS
JDL178B-3-10W	10W	Ø110x54	Ø90-95	1120lm	0.27	36PCS
JDL178B-3-13W	13W	Ø110x54	Ø90-95	1300lm	0.27	36PCS
JDL178-4-10W	10W	Ø145x78	Ø125-135	1150lm	0.48	18PCS
JDL178-4-18W	18W	Ø145x78	Ø125-135	2250lm	0.48	18PCS
JDL178-4-25W	25W	Ø145x78	Ø125-135	2750lm	0.48	18PCS
JDL178-6-18W	18W	Ø172x90	Ø150-165	2200lm	0.71	12PCS
JDL178-6-25W	25W	Ø172x90	Ø150-165	2850lm	0.71	12PCS
JDL178-6-35W	35W	Ø172x90	Ø150-165	3670lm	0.71	12PCS
JDL178-8-18W	18W	Ø228x99	Ø200-210	2070lm	1.14	12PCS
JDL178-8-25W	25W	Ø228x99	Ø200-210	2850lm	1.14	12PCS
JDL178-8-35W	35W	Ø228x99	Ø200-210	4000lm	1.14	12PCS
JDL178-8-40W	40W	Ø228x99	Ø200-210	4200lm	1.14	12PCS
JDL178-8-45W	45W	Ø228x99	Ø200-210	4700lm	1.14	12PCS

CCT — 2700K — 3000K — 4000K — 5000K

Trim — White Black Silver



# JDL179 Downlight

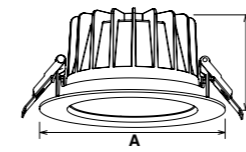

JDL179 SMD LED downlight, designed with a traditional deep reflector and die-casting housing, provides perfect and comfortable lighting and excellent thermal dissipation. External driver solution both in dimmable and non-dimmable version achieves great dimming compatibility with world brand dimmers.

### Reflector



- ▶
- ▶
- ▶
- ▶



Code	Watt	Size(AxBmm)	Cut-out(mm)	Lumen(±5%)	N.W/pc(kgs)	Q'ty/CTN
JDL179A-3-10W	10W	Ø95x54	Ø82-88	830lm	0.23	36PCS
JDL179B-3-10W	10W	Ø110x54	Ø90-95	870lm	0.27	36PCS
JDL179B-3-13W	13W	Ø110x54	Ø90-95	1140lm	0.27	36PCS
JDL179-4-10W	10W	Ø145x78	Ø125-135	900lm	0.46	18PCS
JDL179-4-18W	18W	Ø145x78	Ø125-135	1950lm	0.46	18PCS
JDL179-4-25W	25W	Ø145x78	Ø125-135	2250lm	0.46	18PCS
JDL179-6-18W	18W	Ø172x90	Ø150-165	1900lm	0.67	12PCS
JDL179-6-25W	25W	Ø172x90	Ø150-165	2650lm	0.67	12PCS
JDL179-6-35W	35W	Ø172x90	Ø150-165	3180lm	0.67	12PCS
JDL179-8-18W	18W	Ø228x99	Ø200-210	2070lm	1.08	12PCS
JDL179-8-25W	25W	Ø228x99	Ø200-210	2800lm	1.08	12PCS
JDL179-8-35W	35W	Ø228x99	Ø200-210	4000lm	1.08	12PCS
JDL179-8-40W	40W	Ø228x99	Ø200-210	4400lm	1.08	12PCS
JDL179-8-45W	45W	Ø228x99	Ø200-210	4950lm	1.08	12PCS

CCT — 3000K — 4000K — 5000K — 5700K

Trim — White Black Silver





# JDL197 Downlight

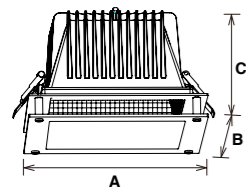

JDL197 deep reflector downlight with decorative frosted glass ring and frosted glass cover options. It provides a softer light output and back light effect. The decorative glass ring or frame are very easy to disassemble. The light effect of the glass cover will be 12% lower than standard cover.

- ▶ 60°
- ▶ IP44
- ▶ IP40
- ▶ UGR<19
- ▶ UGR<20
- ▶ DIM
- ▶ DALI
- ▶ 0-10V
- ▶ AC 220-240V
- ▶ PF≥0.9
- ▶ CRI≥80
- ▶ RoHS
- ▶ CE

Code	Watt	Size(AxBxcm)	Cut-out(mm)	Lumen(±5%)	N.W/pc(kgs)	Q'ty/CTN
JDL197-6-18W	18W	190x190x127 (Drop glass)	170x170	1400lm	1.73	6PCS
JDL197-6-22W	22W	190x190x127 (Drop glass)	170x170	1869lm	1.73	6PCS
JDL197-6-25W	25W	190x190x127 (Drop glass)	170x170	2165lm	1.73	6PCS
JDL197-6-32W	32W	190x190x127 (Drop glass)	170x170	2833lm	1.73	6PCS

CCT 3000K 4000K 5000K 5700K

Trim White Black

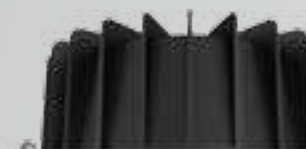

# JDL178 Downlight

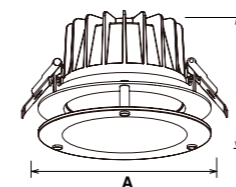

JDL178 deep reflector downlight with decorative frosted glass ring and frosted glass cover options. It provides a softer light output and back light effect. The decorative glass ring or frame are very easy to disassemble. The light effect of the glass cover will be 12~18% lower than standard cover.

### Reflector



Code	Watt	Size(AxBmm)	Cut-out(mm)	Lumen(±5%)	N.W/pc(kgs)	Q'ty/CTN
JDL178-4-10W	10W	172.5x97	Ø125-135	1012lm	1.05	18PCS
JDL178-4-18W	18W	172.5x97	Ø125-135	1980lm	1.05	18PCS
JDL178-4-25W	25W	172.5x97	Ø125-135	2420lm	1.05	18PCS
JDL178-6-18W	18W	197x109	Ø150-165	1936lm	1.30	12PCS
JDL178-6-25W	25W	197x109	Ø150-165	2508lm	1.30	12PCS
JDL178-6-35W	35W	197x109	Ø150-165	3230lm	1.30	12PCS
JDL178-8-18W	18W	246x118	Ø200-210	1822lm	1.84	6PCS
JDL178-8-25W	25W	246x118	Ø200-210	2508lm	1.84	6PCS
JDL178-8-35W	35W	246x118	Ø200-210	3520lm	1.84	6PCS
JDL178-8-40W	40W	246x118	Ø200-210	3696lm	1.84	6PCS
JDL178-8-45W	45W	246x118	Ø200-210	4136lm	1.84	6PCS

CCT 2700K 3000K 4000K 5000K

Trim White Black Silver

- ▶ 24°
- ▶ 36°
- ▶ 60°
- ▶ IP54
- ▶ UGR<19
- ▶ DIM
- ▶ DALI
- ▶ 0-10V
- ▶ AC 200-240V
- ▶ PF≥0.9
- ▶ CRI≥80
- ▶ CRI≥90
- ▶ CRI≥97
- ▶ SAA
- ▶ RoHS
- ▶ CE
- ▶ CB

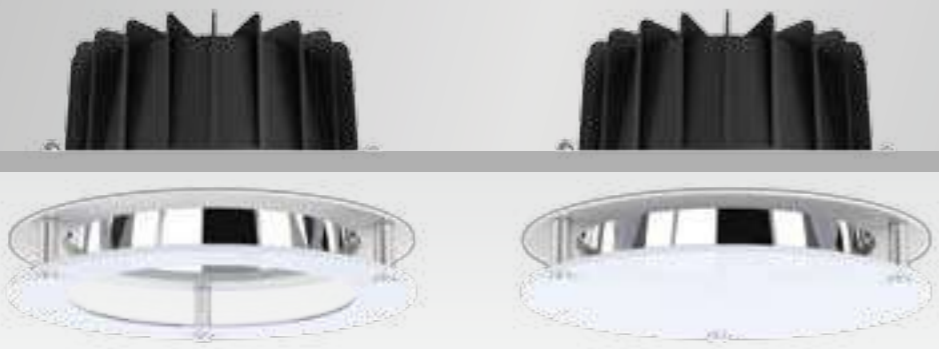

# JDL179 Downlight

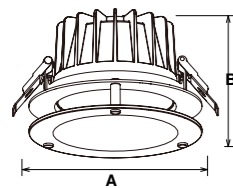

JDL179 deep reflector downlight with decorative frosted glass ring and frosted glass cover options. It provides a softer light output and back light effect. The decorative glass ring or frame are very easy to disassemble. The light effect of the glass cover will be 12~18% lower than standard cover.

### Reflector



Code	Watt	Size(AxBmm)	Cut-out(mm)	Lumen(±5%)	N.W/pc(kgs)	Q'ty/CTN
JDL179-4-10W	10W	172.5x97	Ø125-135	792lm	1.05	18PCS
JDL179-4-18W	18W	172.5x97	Ø125-135	1716lm	1.05	18PCS
JDL179-4-25W	25W	172.5x97	Ø125-135	1980lm	1.05	18PCS
JDL179-6-18W	18W	197x109	Ø150-165	1672lm	1.30	12PCS
JDL179-6-25W	25W	197x109	Ø150-165	2332lm	1.30	12PCS
JDL179-6-35W	35W	197x109	Ø150-165	2798lm	1.30	12PCS
JDL179-8-18W	18W	246x118	Ø200-210	1822lm	1.84	6PCS
JDL179-8-25W	25W	246x118	Ø200-210	2464lm	1.84	6PCS
JDL179-8-35W	35W	246x118	Ø200-210	3520lm	1.84	6PCS
JDL179-8-40W	40W	246x118	Ø200-210	3872lm	1.84	6PCS
JDL179-8-45W	45W	246x118	Ø200-210	4356lm	1.84	6PCS

CCT 3000K 4000K 5000K 5700K

Trim White Black Silver

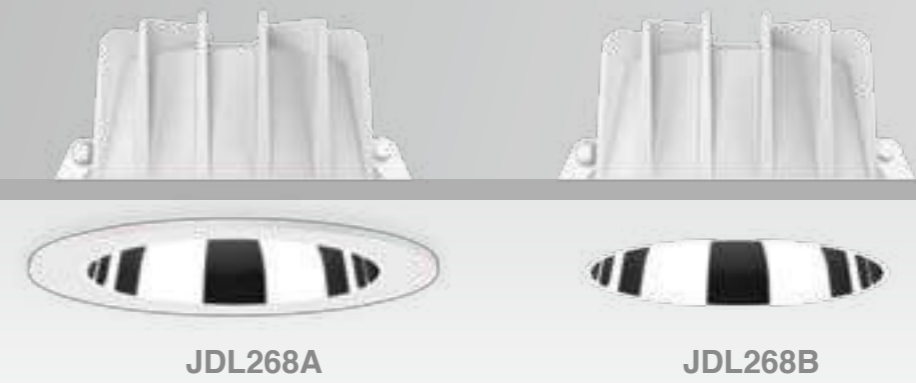

JDL268A

JDL268B

# JDL268 Downlight

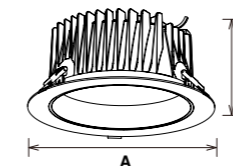

JDL268 downlight with deep reflector design provides excellent lighting experience. 2.5 inch to 10 inch cutout size, 10W to 45W wattage choice, frame and frameless design meet your various demand. Your perfect choice for commercial lighting.

- ▶ IP54
- ▶ 80° beam angle
- ▶ DIM, DALI, 0-10V, TUNABLE WHITE, SLIDE SWITCH
- ▶ AC 200-240V, PF≥0.9, CRI≥80
- ▶ SAA, RoHS, CE, CB

Code	Watt	Size(AxBmm)	Cut-out(mm)	Lumen(±5%)	N.W/pc(kgs)	Q'ty/CTN
JDL268-2.5-10W	10W	Ø95x55	Ø82-88	950lm	0.27	36PCS
JDL268-3-10W	10W	Ø108x55	Ø90-95	950lm	0.29	36PCS
JDL268-3-13W	13W	Ø108x55	Ø90-95	1200lm	0.29	36PCS
JDL268-4-10W	10W	Ø145x77	Ø125-135	1100lm	0.58	18PCS
JDL268-4-18W	18W	Ø145x77	Ø125-135	1900lm	0.58	18PCS
JDL268-4-25W	25W	Ø145x77	Ø125-135	2400lm	0.58	18PCS
JDL268-6-18W	18W	Ø172x90	Ø150-165	2100lm	0.69	12PCS
JDL268-6-25W	25W	Ø172x90	Ø150-165	2650lm	0.69	12PCS
JDL268-6-35W	35W	Ø172x90	Ø150-165	3500lm	0.69	12PCS
JDL268-8-18W	18W	Ø228x107	Ø200-210mm	2100lm	1.13	12PCS
JDL268-8-25W	25W	Ø228x107	Ø200-210mm	2900lm	1.13	12PCS
JDL268-8-35W	35W	Ø228x107	Ø200-210mm	4000lm	1.13	12PCS
JDL268-8-45W	45W	Ø228x107	Ø200-210mm	4900lm	1.13	12PCS
JDL268-10-35W	35W	Ø280x123	Ø230-260mm	3800lm	1.55	6PCS
JDL268-10-45W	45W	Ø280x123	Ø230-260mm	4900lm	1.55	6PCS
JDL268-10-50W	50W	Ø280x123	Ø230-260mm	5300lm	1.55	6PCS

CCT 3000K 4000K 5000K 5700K

Trim White Black



# JDL315 Downlight

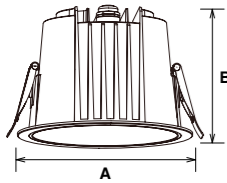

JDL315 deep reflector downlight which adopts high lumen efficiency SMD 100lm/W, ADC12 Aluminum offers a great thermal management. Three covers for option, honeycomb cover and tri-reflector cover make a low UGR. Adapter ring makes a wider application area and convenient installation. IP54 in front and tri-color changeable are available.

- ▶
  - ▶
  - ▶
  - ▶
- 

Code	Watt	Size(AxBmm)	Cut-out(mm)	Lumen(±5%)	N.W/pc(kgs)	Q'ty/CTN
JDL315-2.5	6W	Ø87x73	Ø68-75	630lm	0.24	24PCS
JDL315-3-10W	10W	Ø110x84	Ø95-100	780lm	0.31	18PCS
JD L315-3-13W	13W	Ø110x84	Ø95-100	986lm	0.31	18PCS
JDL315-4-18W	18W	Ø135x96	Ø120-125	1530lm	0.46	18PCS
JDL315-4-25W	25W	Ø135x96	Ø120-125	2043lm	0.46	18PCS
JDL315-6-25W	25W	Ø160x117	Ø150-155	2334lm	0.64	12PCS
JDL315-6-35W	35W	Ø160x117	Ø150-155	2434lm	0.64	12PCS
JDL315-8-35W	35W	Ø186x128	Ø170-175	3405lm	0.85	6PCS
JDL315-8-42W	42W	Ø186x128	Ø170-175	3367lm	0.85	6PCS

CCT ——— 3000K 4000K 5000K 5700K

Trim ——— White Black

## MORE POSSIBILITIES

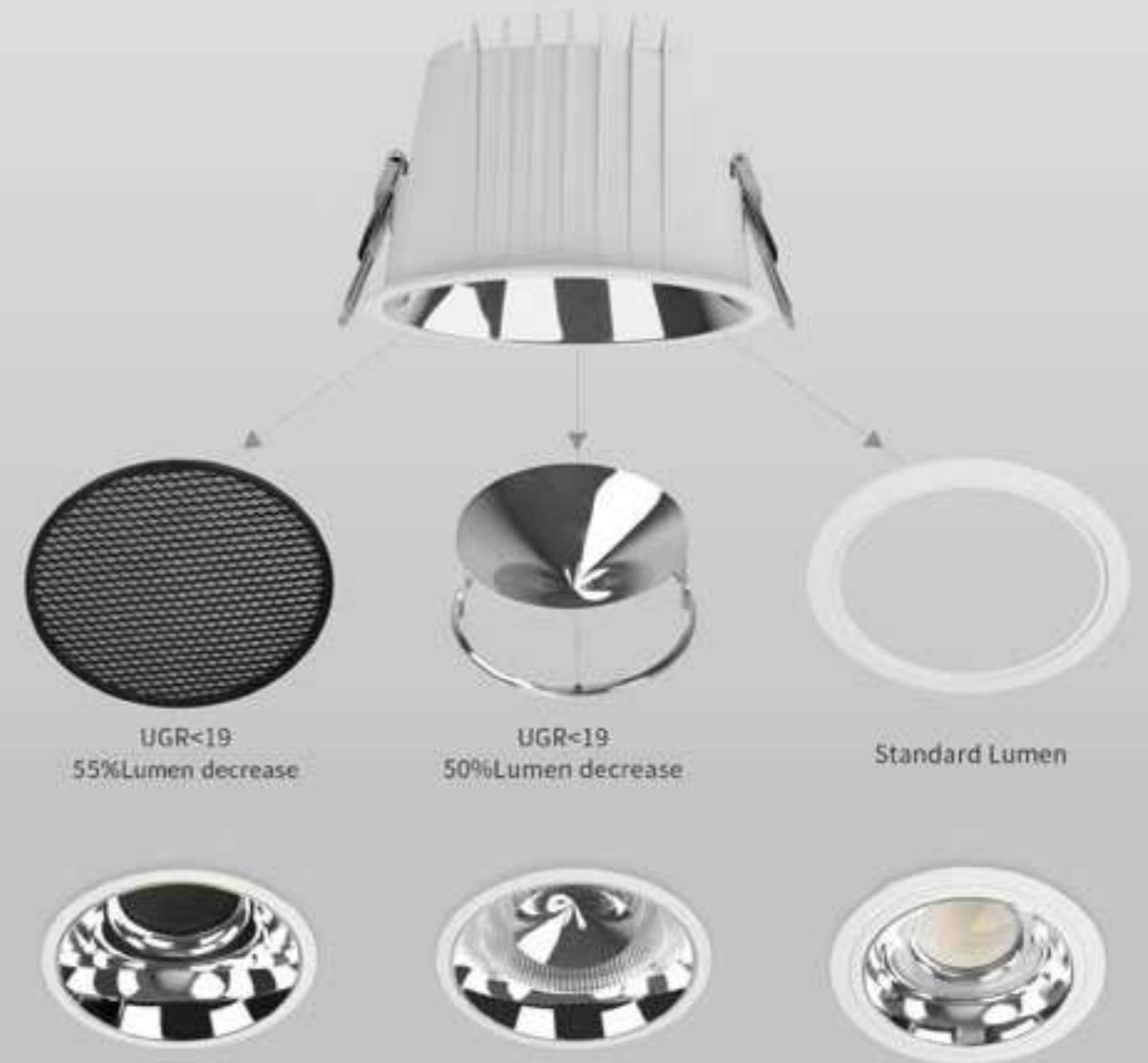

GLOWING EFFECT

GLOWING EFFECT

GLOWING EFFECT



## JDL98A/B Downlight

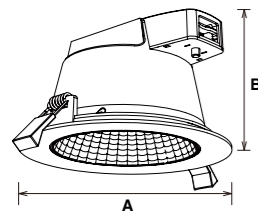

JDL98 integrated SMD LED downlight series, a high-performance LED downlight for accenting and general lighting, has two reflector design optional, JDL98A with faceted reflector and JDL98B with specular reflector. The luminaire is easy to install with the combination of integrated driver and fast connector. Triac dimmable and 3CCT are available.

### Reflector

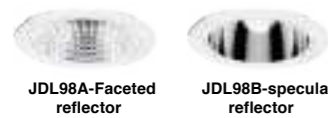

- ▶
- ▶
- ▶
- ▶



Code	Watt	Size(AxBmm)	Cut-out(mm)	Lumen(±5%)	N.W/pc(kgs)	Q'ty/CTN
JDL98-3-6W	6W	Ø110x70	Ø90-95	610lm	0.18	24PCS
JDL98-4-13W	13W	Ø145x82	Ø125-135	1460lm	0.28	24PCS
JDL98-6-18W	18W	Ø172x95	Ø150-165	1890lm	0.35	12PCS
JDL98-8-18W	18W	Ø228x98	Ø200-210	2110lm	0.54	12PCS
JDL98-8-25W	25W	Ø228x98	Ø200-210	2930lm	0.54	12PCS

CCT — 3000K 4000K 5000K 5700K

Trim — White Black



## JDL138A/B Downlight

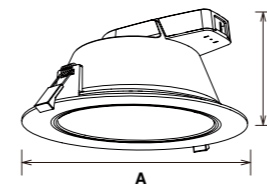

JDL138 series SMD LED downlight, slide switch for color selection, is good for home and commercial project requirement. IP54 rated is available for bathrooms and other wet locations. JDL98B 60° beam angle with specular reflector can reach UGR<19.

### Reflector

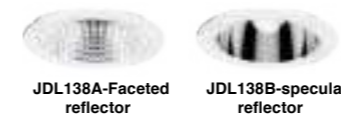

- ▶
- ▶
- ▶
- ▶



Code	Watt	Size(AxBmm)	Cut-out(mm)	Lumen(±5%)	N.W/pc(kgs)	Q'ty/CTN
JDL138-3-6W	6W	Ø110x70	Ø90-95	560lm	0.24	24PCS
JDL138-4-13W	13W	Ø145x82	Ø125-135	1390lm	0.34	24PCS
JDL138-6-18W	18W	Ø172x95	Ø150-165	1780lm	0.45	12PCS
JDL138-8-18W	18W	Ø228x98	Ø200-210	2110lm	0.65	12PCS
JDL138-8-25W	25W	Ø228x98	Ø200-210	2880lm	0.65	12PCS

CCT — 3000K 4000K 5000K 5700K

Trim — White Black



## JDL83 Downlight

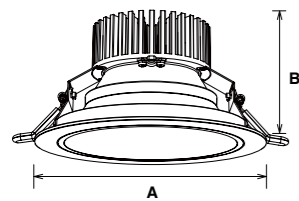

JDL83 SMD downlight, a high-performance LED downlight for accenting and general lighting. Designed with a micro prism diffuser, the luminaire provides enhanced glare control and leading performance, making it ideal for commercial and residential environments. ADC12 Aluminum profile design guarantee long lifespan.

- ▶ 60° IP20
- ▶ DIM DALI 0-10V
- ▶ AC 200-240V PF<sub>≥</sub>0.9 CRI<sub>≥</sub>80
- ▶ SAA RoHS CE



Code	Watt	Size(AxBmm)	Cut-out(mm)	Lumen(±5%)	N.W/pc(kgs)	Q'ty/CTN
JDL83-3-13W	13W	Ø110x80	Ø90-100	1160lm	0.33	30PCS
JDL83-6-25W	25W	Ø190x100	Ø160-180	2620lm	0.76	12PCS
JDL83-8-35W	35W	Ø230x110	Ø200-220	3700lm	0.98	12PCS

CCT — 3000K 4000K 5000K 5700K

Trim — White Black Silver



## JCL94 Downlight

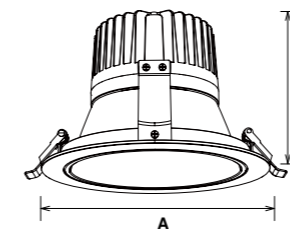

JCL94 LED downlight designed with a deep reflector, provides optimal glare control(UGR<19). It adopts brand CITIZEN COB for uniform and accenting lighting. Ideal for commercial and residential applications looking for a clean, minimalist look.

- ▶ 36° 45° IP20 UGR<19
- ▶ DIM DALI 0-10V
- ▶ AC 200-240V PF<sub>≥</sub>0.9 CRI<sub>≥</sub>80 CRI<sub>≥</sub>90 CRI<sub>≥</sub>97
- ▶ SAA RoHS CE



Code	Watt	Size(AxBmm)	Cut-out(mm)	Lumen(±5%)	N.W/pc(kgs)	Q'ty/CTN
JCL94-3-13W	13W	Ø110x100	Ø95-100	920lm	0.38	24PCS
JCL94-6-25W	25W	Ø190x127	Ø165-180	2550lm	0.85	12PCS
JCL94-8-35W	35W	Ø230x140	Ø205-220	3350lm	1.20	12PCS

CCT — 2700K 3000K 4000K 5000K

Trim — White Black Silver



## JDL322A Downlight

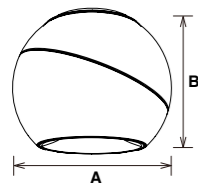

JDL322A adopts high lumen COB chip. The type A is surface mounted. AL6063 aluminum lamp body provides excellent heat dissipation. Beam angle 36 and 60 degree adjustable.

- ▶ 36° 60° IP20
- ▶ DIM
- ▶ AC 220-240V PF≥0.9 CRI≥80
- ▶ RoHS CE

Code	Watt	Size(AxBxCmm)	Lumen(±5%)	N.W/pc(kgs)	Q'ty/CTN
JDL322A-10W	10W	Ø120x98	900lm	0.80	12PCS
JDL322A-15W	15W	Ø120x98	1400lm	0.80	12PCS

CCT — 2700K 3000K 4000K 5000K

Finish — White Black



## JDL176 Downlight

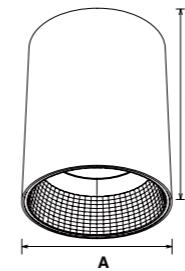

JDL176 downlight with deep-set reflector provides better glaring control(UGR<19). It offers a wide choice of outputs, beam angles and color rendering options. Surface mounted down light with no-screw outside fixation provide a much cleaner out-looking design. Built-in driver, easy for installation.

- ▶ 24° 36° 60° IP54 UGR<19
- ▶ DIM DALI
- ▶ AC 200-240V PF≥0.9 CRI≥80 CRI≥90 CRI≥97
- ▶ SAA RoHS CE CB

Code	Watt	Size(AxBmm)	Lumen(±5%)	N.W/pc(kgs)	Q'ty/CTN
JDL176-15W	15W	Ø100x134	1750lm	0.65	18PCS
JDL176-25W	25W	Ø120x144	2800lm	0.84	12PCS
JDL176-35W	35W	Ø170x159	3900lm	1.45	6PCS

CCT — 2700K 3000K 4000K 5000K

Finish — White Black Silver



# JDL269 Downlight

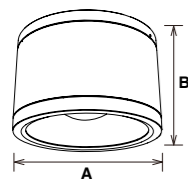

JDL269 series downlight with IP65 waterproof design is widely used for indoor and semi-outdoor environment. It is with high lumen SMD chip and external and flicker free driver, 3 CCT switchable. 3/5/6/8/10 inches sizes are optional. It's ideal luminaire to indoor and outdoor applications.

- ▶ 24° 36° 60° 70° 75° 80°
- ▶ IP65
- ▶ SLIDE SWITCH
- ▶ AC 200-240V PF≥0.9 CRI≥80
- ▶ RoHS CE

Code	Watt	Size(AxBmm)	Lumen(±5%)	N.W/pc(kgs)	Q'ty/CTN
JDL269A/B-3-10W	10W	Ø90x170	1100lm	0.60	12PCS
JDL269A/B-3-15W	15W	Ø90x170	1600lm	0.60	12PCS
JDL269A/B-5-18W	18W	Ø130x115	1900lm	0.92	12PCS
JDL269A/B-5-20W	20W	Ø130x115	2200lm	0.92	12PCS
JDL269A/B-5-25W	25W	Ø130x115	2500lm	0.92	12PCS
JDL269A/B-6-25W	25W	Ø160x110	2500lm	1.18	6PCS
JDL269A/B-6-30W	30W	Ø160x110	3200lm	1.18	6PCS
JDL269A/B-8-25W	25W	Ø214x119	2500lm	2.20	6PCS
JDL269A/B-8-35W	35W	Ø214x119	3500lm	2.20	6PCS
JDL269A/B-8-40W	40W	Ø214x119	4000lm	2.20	6PCS
JDL269A/B-10-35W	35W	Ø250x125	3500lm	2.80	4PCS
JDL269A/B-10-40W	40W	Ø250x125	4500lm	2.80	4PCS
JDL269A/B-10-50W	50W	Ø250x125	5200lm	2.80	4PCS

CCT — 3000K 4000K 5000K 5700K      Finish — White



# JDL38 Downlight

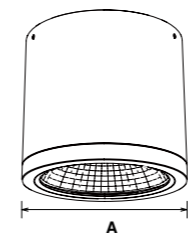

JDL38 surface mounted downlight is a high-performance LED luminaire that can simultaneously or individually offer uniform and excellent light. It offers a wide choice of beam angles 24°/36°/45°/60° for optional. AL6063 Aluminum body with oxidation treatment provides excellent heat dissipation performance.

- ▶ 24° 36° 45° 60°
- ▶ IP54
- ▶ DIM DALI
- ▶ AC 100-240V AC 200-240V PF≥0.9 CRI≥80 CRI≥90 CRI≥97
- ▶ SAA RoHS CE

Code	Watt	Size(AxBmm)	Lumen(±5%)	N.W/pc(kgs)	Q'ty/CTN
JDL38-10W	10W	Ø90x100	890lm	0.52	24PCS
JDL38-15W	15W	Ø90x100	1600lm	0.52	24PCS
JDL38-25W	25W	Ø120x110	3070lm	0.75	18PCS
JDL38-30W-DA	30W	Ø160x120	3500lm	1.50	12PCS
JDL38-32W	32W	Ø160x120	3540lm	1.50	12PCS

CCT — 2700K 3000K 4000K 5000K      Finish — White Black Silver



# JDL160 Downlight

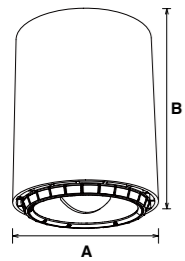

JDL160 DIY modular design is a high-performance LED downlight for premium hotel and high-end commercial project requirement. Adjustable beam angle from 20° to 70° for accenting and general lighting. Available in an array of trims and accessories, these luminaires are here to outperform to fit into ceiling, recessed, and track mounting installation.

- ▶ 20°-70° IP20
- ▶ DIM
- ▶ 

AC 100-240V	AC 220-240V	PF≥0.9	CRI≥80	CRI≥90	CRI≥97
-------------	-------------	--------	--------	--------	--------
- ▶ RoHS CE

Code	Watt	Size(AxBxCmm)	Lumen(±5%)	N.W/pc(kgs)	Q'ty/CTN
JDL160-25W	25W	Ø100x131.5	3250lm	0.98	18PCS
JDL160-100-A	Trim	Ø100x66	Trim	0.35	36PCS
JDL160-175-B	Trim	Ø175x48	Trim	0.35	24PCS
JDL160-175-C	Trim	175x175x48	Trim	0.40	24PCS
JTL147-25W	Adapter	Ø100x157x108	Adapter	0.45	24PCS

CCT — 2700K 3000K 4000K 5000K Finish — White Black Silver

## JDL160 DIY module

**JDL160-100-A**

**JDL160-175-B**

**JDL160-175-C**

**JBLP-TL47-25W**

LED Downlight  
Surface mounted &  
Pendant Series





# JDL129 Downlight

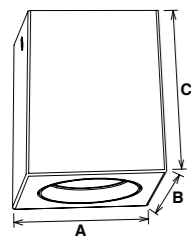

JDL129 square surface mounted downlight adopts brand CITIZEN COB and high reflective (more than 88%) for accenting and general lighting. Adjustale lighting direction, 350° in horizontal and 25° in vertical. The luminaire offers a choice of beam angles, color rendering options, making it ideal for commercial, and residential environments.

- ▶ 24° 36° 60° 350° 25° IP20
- ▶ DIM
- ▶ AC 100-240V AC 220-240V CRI≥80 CRI≥90 CRI≥97
- ▶ SAA RoHS CE

Code	Watt	Size(AxBxCmm)	Lumen(±5%)	N.W/pc(kgs)	Q'ty/CTN
JDL129-90-6W	6W	90x90x110	630lm	0.60	24PCS
JDL129-90-10W	10W	90x90x110	1030lm	0.60	24PCS
JDL129-115-20W	20W	115x115x122	2350lm	0.90	18PCS

CCT



# JDL130 Downlight

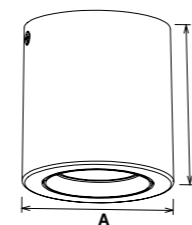

JDL130 round surface mounted downlight adopts brand CITIZEN COB and high reflective (more than 88%) for accenting and general lighting. Adjustale lighting direction, 350° in horizontal and 25° in vertical. The luminaire offers a choice of beam angles, color rendering options, making it ideal for commercial, and residential environments.

- ▶ 24° 36° 60° 350° 25° IP20
- ▶ DIM
- ▶ AC 100-240V AC 220-240V CRI≥80 CRI≥90 CRI≥97
- ▶ SAA RoHS CE

Code	Watt	Size(AxBmm)	Lumen(±5%)	N.W/pc(kgs)	Q'ty/CTN
JDL130-90-6W	6W	Ø90x110	630lm	0.55	24PCS
JDL130-90-10W	10W	Ø90x110	1030lm	0.55	24PCS
JDL130-115-20W	20W	Ø115x122	2350lm	0.83	18PCS

CCT



# JDL244 Downlight

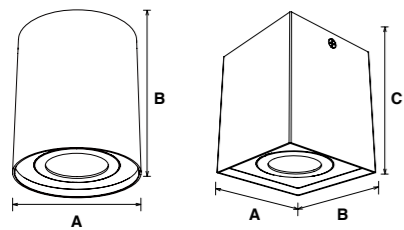

JDL244 surface mounted downlight, adopting high lumen COB 100lm/W, ADC12 heat sink and multi-layer structure provide excellent thermal dissipation. Built-in driver solution both in dim and Non-dim version achieves great dimming compatibility with the worldwide brand dimmers. 360° in horizontal and 23° in vertical and IP54 are available.

- ▶ 15° 24° 36° 60°
- ▶ IP54
- ▶ DIM
- ▶ AC 200-240V CRI ≥ 80
- ▶ RoHS CE

Code	Watt	Size(AxBxCmm)	Lumen(±5%)	N.W/pc(kgs)	Q'ty/CTN
JDL244-90-6W	6W	Ø90x108	730lm	0.44	24PCS
JDL244-90-10W	10W	Ø90x108	1090lm	0.44	24PCS
JDL244-90-6W	6W	90x90x108	730lm	0.52	24PCS
JDL244-90-10W	10W	90x90x108	1090lm	0.52	24PCS

CCT — 2700K 3000K 4000K 5000K

Finish — White Black Silver Nickel

# JDL244 Series

High transmittance lens and high reflective reflector option

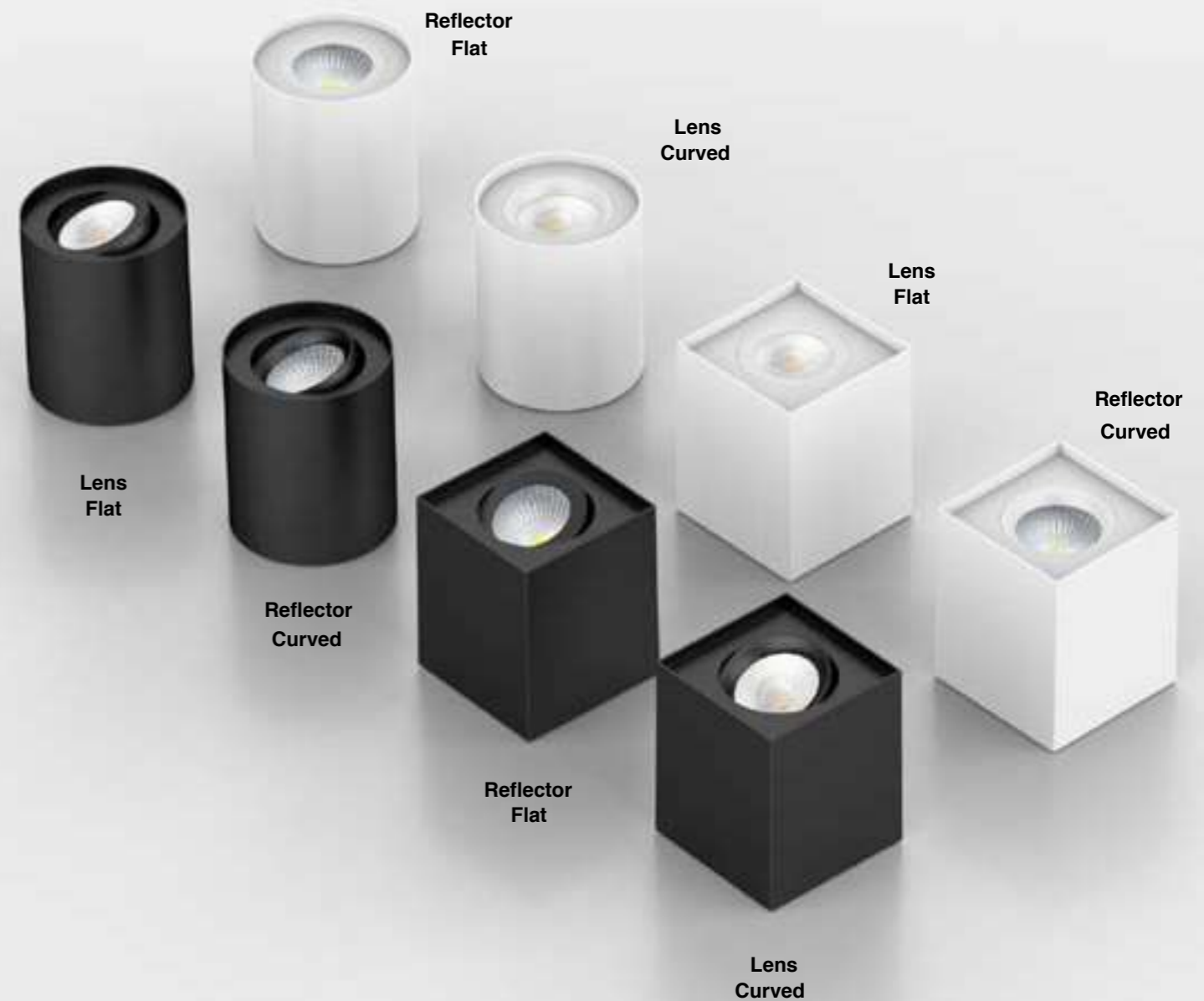



## JDL277A/B Downlight

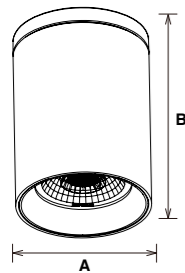

JDL277A/B surface mounted downlight adopts high lumen LED chip and PC lens which make sure the high luminous, JDL277A adopts COB chip with four beam angle options: 15°/24°/36°/60°, DL277B adopts SMD chip with 36°/60° beam angle options. 6063 aluminum housing provides excellent thermal dissipation. The installation is very easy, screwless design on surface gives the lamp an IP54 protection level.

- ▶ 15° 24° 30° 36° 60° IP54
- ▶ DIM
- ▶ AC 200-240V PF≥0.9 CRI≥80 CRI≥90
- ▶ RoHS CE

Code	Watt	Size(AxBmm)	Lumen(±5%)	N.W/pc(kgs)	Q'ty/CTN
JDL277A - 6W	6W	Ø70x100	621lm	0.32	24PCS
JDL277B - 6W	6W	Ø70x100	600lm	0.32	24PCS
JDL277A-10W	10W	Ø70x100	1000lm	0.32	24PCS
JDL277B-10W	10W	Ø70x100	1000lm	0.32	24PCS

CCT — 2700K 3000K 4000K 5000K

Finish — White Black



## JDL277C Downlight

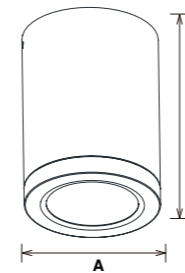

JDL277C surface mounted downlight adopts high lumen LED chip and PC lens which make sure the high luminous. JDL277C adopts LEDiL-RONDA lens, single asymmetric and double asymmetric 6 lens optional and replaceable, 360 degree rotation to adjust lighting direction. 6063 aluminum housing provides excellent thermal dissipation. The installation is very easy, screwless design on surface gives the lamp an IP20 protection level.

- ▶ 30° 45° 60° IP20
- ▶ DIM
- ▶ AC 200-240V PF≥0.9 CRI≥80 CRI≥90
- ▶ RoHS CE

### Polarized Light Display

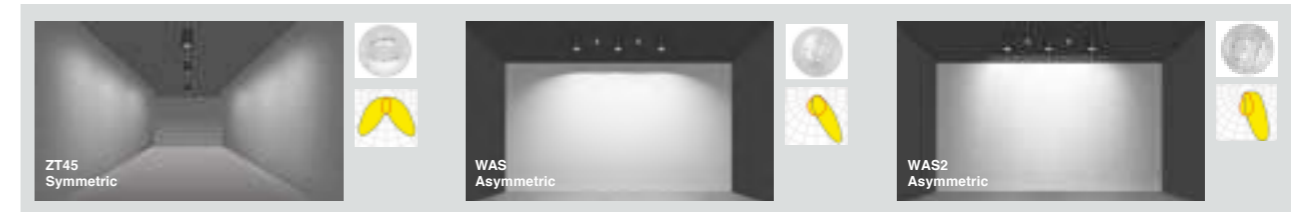

Code	Watt	Size(AxBmm)	Lumen(±5%)	N.W/pc(kgs)	Q'ty/CTN
JDL277C-6W	6W	Ø70x102	660lm	0.33	24PCS
JDL277C-10W	10W	Ø70x102	1000lm	0.33	24PCS

CCT — 2700K 3000K 4000K 5000K Finish — White Black

Interchangeable lens options — 30° 45° 60° WAS Asymmetric ZT45 Symmetric WAS2 Asymmetric



## JDL297B Downlight

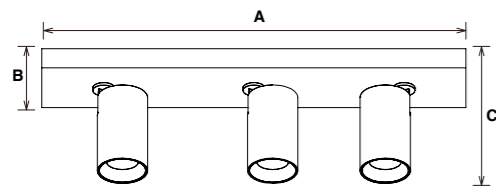

JDL297B is a surface mounted COB downlight with aluminum body and cylindrical appearance design. CRI80 and CRI90 available, IP20, support non-dimmable and triac dimmable. PC Lens with 24 and 36 beam angle for options.

- ▶ 24° 36° IP20
- ▶ DIM
- ▶ AC 220-240V PF ≥ 0.9 CRI ≥ 80 CRI ≥ 90
- ▶ RoHS CE



Code	Watt	Size(AxBxCmm)	Lumen(±5%)	N.W/pc(kgs)	Q'ty/CTN
JDL297B-0911-10W	10W	110x90x134	800lm	0.62	24PCS
JDL297B-0911-14W	14W	110x90x134	1100lm	0.62	24PCS
JDL297B-0930-20W	20W	305x90x134	1600lm	1.13	12PCS
JDL297B-0930-28W	28W	305x90x134	2250lm	1.13	12PCS
JDL297B-0948-30W	30W	480x90x134	2400lm	1.58	6PCS
JDL297B-0948-42W	42W	480x90x134	3350lm	1.58	6PCS

CCT — 2700K 3000K 4000K 5000K

Trim — White Black



## JDL207 Downlight

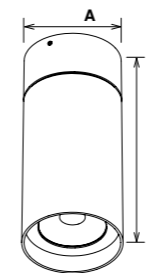

JDL207 surface mounted LED downlight, with the special design of adjusting lighting orientation, 330° rotate and 90° tilt. The luminaire adopts CITIZEN brand COB, makes uniform light and excellent lumen output. Aluminum profile with sufficient heat management guarantee long lifespan.

- ▶ 36° 60° 330° 90° IP20
- ▶ DIM
- ▶ AC 100-240V AC 200-240V CRI ≥ 80 CRI ≥ 90 CRI ≥ 97
- ▶ SAA RoHS CE

Code	Watt	Size(AxBmm)	Lumen(±5%)	N.W/pc(kgs)	Q'ty/CTN
JDL207-15W	15W	Ø85x186	1750lm	0.67	12PCS
JDL207-25W	25W	Ø85x211	2900lm	0.73	12PCS

CCT — 2700K 3000K 4000K 5000K

Finish — White Black Silver



## JDL259 Downlight

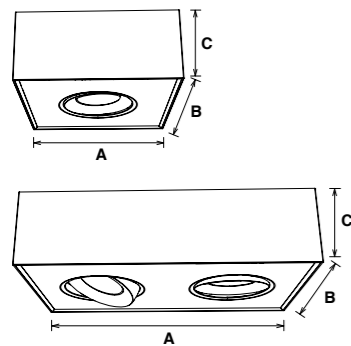

JDL259 LED surface mounted downlight with flicker free built-in driver design, adopting Edison COB and aluminium lamp body which provides good heat dissipation. Dim-to-Warm version (2000K~3000K) is available. Tilt 30° in all directions(360°).

- ▶ 15° 24° 30° 36°
- ▶ 60° IP20
- ▶ DIM
- ▶ AC 200-240V PF≥0.9 CRI≥90 CRI≥97
- ▶ RoHS CE

Code	Watt	Size(AxBxCmm)	Lumen(±5%)	N.W/pc(kgs)	Q'ty/CTN
JDL259-8W-D	8W	135x135x60	700lm	0.58	24PCS
JDL259-8W-DW	8W	135x135x60	440lm	0.58	24PCS
JDL259-16W-D	16W	224x135x60	1600lm	0.91	12PCS
JDL259-16W-DW	16W	224x135x60	950lm	0.91	12PCS

CCT — 2700K 3000K 4000K 5000K

Finish — White Black Silver Nickel Brushed

## JDL300B Downlight

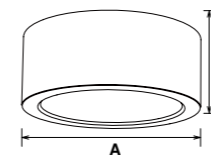

JDL300 downlight with SMD chip and build-in driver design supports dimmable, 3CCT changeable and sensor functions. Meanwhile it is with recessed and surface mounted installation ways. IP20 for indoor use only. It's a high cost-effective downlight.

- ▶ 120° IP20
- ▶ DIM 3 CCT ((-))
- ▶ AC 200-240V PF≥0.9 CRI≥80
- ▶ RoHS CE

Code	Watt	Size(AxBmm)	Lumen(±5%)	N.W/pc(kgs)	Q'ty/CTN
JDL300B-18W	18W	Ø190x70	1980lm	0.35	12PCS
JDL300B-20W	20W	Ø230x70	2200lm	0.45	12PCS
JDL300B-25W	25W	Ø280x70	2750lm	0.55	12PCS

CCT — 3000K 4000K 5000K 5700K

Trim — White Black



# JDL266S Downlight

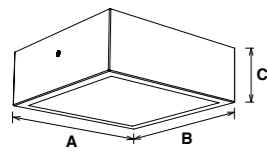

JDL266S surface mounted downlight adopts 2835 SMD and PMMA LGP. The die-casting aluminum frame provides a great thermal management. The external driver design and 3 CCT interchangeable are available.

- ▶ 120° IP20
- ▶ DIM
- ▶ AC 200-240V PF ≥ 0.9 CRI ≥ 80
- ▶ SAA RoHS CE

Code	Watt	Size(AxBxCmm)	Lumen(±5%)	N.W/pc(kgs)	Q'ty/CTN
JDL266-6W-S	6W	120x120x38	420lm	0.37	36PCS
JDL266-12W-S	12W	170x170x38	950lm	0.48	24PCS
JDL266-18W-S	18W	224x224x38	1500lm	0.77	12PCS
JDL266-24W-S	24W	300x300x38	2000lm	0.95	12PCS

CCT — 3000K 4000K 5000K 5700K 6500K Finish — White Black Silver

# JDL266R Downlight

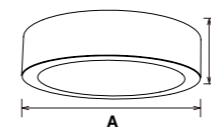

JDL266R surface mounted downlight adopts 2835 SMD and PMMA LGP. The die-casting aluminum frame provides a great thermal management. The external driver design and 3 CCT interchangeable are available.

- ▶ 120° IP20
- ▶ DIM
- ▶ AC 200-240V PF ≥ 0.9 CRI ≥ 80
- ▶ SAA RoHS CE

Code	Watt	Size(AxBmm)	Lumen(±5%)	N.W/pc(kgs)	Q'ty/CTN
JDL266-6W-R	6W	Ø120x38	420lm	0.35	36PCS
JDL266-12W-R	12W	Ø170x38	950lm	0.45	24PCS
JDL266-18W-R	18W	Ø224x38	1500lm	0.75	12PCS
JDL266-24W-R	24W	Ø300x38	2000lm	0.93	12PCS

CCT — 3000K 4000K 5000K 5700K 6500K Finish — White Black Silver



# JDL51 Downlight

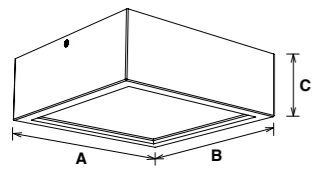

JDL51 square surface mounted SMD downlight adopts PMMA high-efficient diffuser with special structure surface creat uniform light effect. Driver built-in, easy for installation. An IP54-rated version for bathrooms and other wet locations is also available.

- ▶ 100°
- ▶ DIM
- ▶ AC 220-240V PF≥0.9 CRI≥80
- ▶ SAA RoHS CE



Code	Watt	Size(AxBxCmm)	Lumen(±5%)	N.W/pc(kgs)	Q'ty/CTN
JDL51-8W	8W	100x100x59	696lm	0.35	30PCS
JDL51-15W	15W	150x150x59	1365lm	0.57	24PCS
JDL51-18W	18W	170x170x59	1692lm	0.71	24PCS

CCT  3000K  4000K  5000K  5700K **Finish**  White  Black  Silver



# JDL52 Downlight

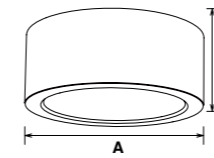

JDL52 round surface mounted SMD downlight adopts PMMA high-efficient diffuser with special structure surface creat uniform light effect. Driver built-in, easy for installation. An IP54-rated version for bathrooms and other wet locations is also available.

- ▶ 100°
- ▶ DIM
- ▶ AC 220-240V PF≥0.9 CRI≥80
- ▶ SAA RoHS CE



Code	Watt	Size(AxBmm)	Lumen(±5%)	N.W/pc(kgs)	Q'ty/CTN
JDL52-8W	8W	Ø100x60	744lm	0.35	30PCS
JDL52-12W	12W	Ø150x68	1140lm	0.69	24PCS
JDL52-15W	15W	Ø150x68	1380m	0.69	24PCS
JDL52-18W	18W	Ø170x68	1782lm	0.86	24PCS

CCT  3000K  4000K  5000K  5700K **Finish**  White  Black  Silver



# JDL228A Downlight

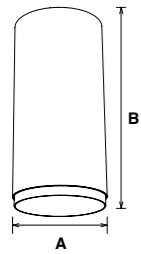

JDL228A adopt high lumen COB chip and PMMA lens for uniform light effect and enhanced glare control. Aluminum profile with sufficient heat dissipation guarantee long lifespan. It offers a wide choice of beam angles 24°/30°/36°/45°/60° for optional.

- ▶ 24° 30° 36° 45° 60° IP20
- ▶ DIM
- ▶ AC 200-240V PF≥0.9 CRI≥80 CRI≥90 CRI≥97
- ▶ SAA RoHS CE CB

Code	Watt	Size(AxBmm)	Lumen(±5%)	N.W/pc(kgs)	Q'ty/CTN
JDL228A-10W	10W	Ø65x157	1100lm	0.45	12PCS
JDL228A-15W	15W	Ø65x157 (Non-dim) Ø85x178 (Triac-dim)	1300lm	0.45	12PCS
JDL228A-20W	20W	Ø85x178	2250lm	0.67	12PCS
JDL228A-25W	25W	Ø85x178	2700lm	0.67	12PCS
JDL228A-30W	30W	Ø100x211	3050lm	1.00	12PCS
JDL228A-40W	40W	Ø100x211	4200lm	1.00	12PCS

CCT — 2700K 3000K 4000K 5000K Finish — White Black

Interchangeable lens options — 24°/30°/45° for 10W/15W 24°/36°/60° for 15W/20W/25W/30W/40W



# JDL228B Downlight

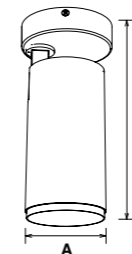

JDL228B surface mounted downlight with adjustable lighting orientation, 350° rotate and 90° tilt, It offers a wide choice of beam angles 24°/30°/36°/45°/60° for optional. Aluminum profile with sufficient heat dissipation guarantee long lifespan. Driver built-in, easy for installation.

- ▶ 24° 30° 36° 45°
- ▶ 60° 350° 90° IP20
- ▶ DIM
- ▶ AC 200-240V PF≥0.9 CRI≥80 CRI≥90 CRI≥97
- ▶ SAA RoHS CE CB

Code	Watt	Size(AxBmm)	Lumen(±5%)	N.W/pc(kgs)	Q'ty/CTN
JDL228B-10W	10W	Ø65x218	1100lm	0.55	12PCS
JDL228B-15W	15W	Ø65x218 (Non-dim) Ø85x241 (Triac-dim)	1300lm	0.55	12PCS
JDL228B-20W	20W	Ø85x241	2250lm	0.82	12PCS
JDL228B-25W	25W	Ø85x241	2700lm	0.82	12PCS
JDL228B-30W	30W	Ø100x274	3050lm	1.15	12PCS
JDL228B-40W	40W	Ø100x274	4200lm	1.15	12PCS

CCT — 2700K 3000K 4000K 5000K Finish — White Black

Interchangeable lens options — 24°/30°/45° for 10W/15W 24°/36°/60° for 15W/20W/25W/30W/40W





# JPD228 Downlight

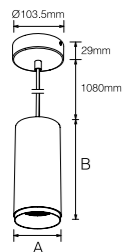

JPD228 pendant spot light is a high-performance LED luminaire that is ideal for commercial or residential applications. It adopts high lumen COB chip and PMMA lens for uniform light effect and enhanced glare control. AL6063 Aluminum profile with sufficient heat dissipation guarantee long lifespan.

- ▶ 24° 30° 36° 45° 60° IP20
- ▶ DIM
- ▶ AC 200-240V PF ≥ 0.9 CRI ≥ 80 CRI ≥ 90 CRI ≥ 97
- ▶ SAA RoHS CE CB

Code	Watt	Size(AxBmm)	Lumen(±5%)	N.W/pc(kgs)	Q'ty/CTN
JPD228-10W	10W	Ø65x157	1100lm	0.55	12PCS
JPD228-15W	15W	Ø65x157 (Non-dim) Ø85x178 (Triac-dim)	1300lm	0.55	12PCS
JPD228-20W	20W	Ø85x178	2250lm	0.80	12PCS
JPD228-25W	25W	Ø85x178	2700lm	0.80	12PCS
JPD228-30W	30W	Ø100x211	3050lm	1.15	12PCS
JPD228-40W	40W	Ø100x211	4200lm	1.15	12PCS

CCT — 2700K 3000K 4000K 5000K Finish — White Black

Interchangeable lens options — 24°/30°/45° for 10W/15W 24°/36°/60° for 15W/20W/25W/30W/40W



# JPD02A&B Downlight

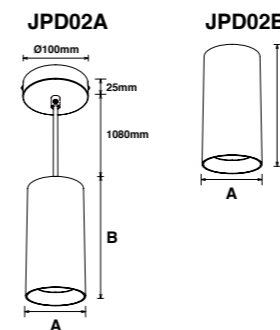

JPD02A pendant spot light and JPD02B surface mounted downlight with stylish appearance, making it ideal for commercial and residential applications looking for a clean, minimalist look. Adopted brand CREE COB for uniform and accenting lighting. Aluminum profile with sufficient heat management guarantee long lifespan.

- ▶ 10° 15° 24° 36° IP20
- ▶ DIM
- ▶ AC 100-240V AC 200-240V PF ≥ 0.9 CRI ≥ 80 CRI ≥ 90 CRI ≥ 97
- ▶ SAA RoHS CE

Code	Watt	Size(AxBmm)	Lumen(±5%)	N.W/pc(kgs)	Q'ty/CTN
JPD02A-10W	10W	Ø80x130	1030lm	0.75	24PCS
JPD02A-18W	18W	Ø80x160	1800lm	0.81	24PCS
JPD02A-25W	25W	Ø112.5x160	2765lm	0.95	24PCS
JPD02B-10W	10W	Ø80x130	900lm	0.50	24PCS
JPD02B-18W	18W	Ø80x160	1660lm	0.56	24PCS
JPD02B-25W	25W	Ø112.5x160	2765lm	0.75	24PCS

CCT — 2700K 3000K 4000K 5000K Finish — White Black

Decoration Ring — White Black Other



# JDL115A/B Downlight

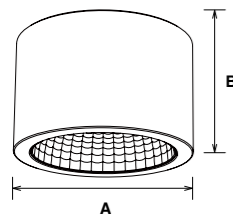

JDL115A/B SMD compact and neat surface mounted downlight series with 3 CCT in 1 lamp optional, slide switch for color selection are good for commercial project requirement. An IP54-rated version for indoor use. 60° beam angle with specular reflector can reach UGR<19.

### Reflector

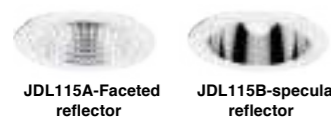

- ▶ 60° 90°
- ▶ IP54 UGR<19
- ▶ DIM SLIDE SWITCH 3 in 1
- ▶ AC 100-277V AC 200-240V PF≥0.9 CRI≥80
- ▶ SAA RoHS CE



Code	Watt	Size(AxBmm)	Lumen(±5%)	N.W/pc(kgs)	Q'ty/CTN
JDL115-4-13W	13W	Ø143x112	1460lm	0.39	12PCS
JDL115-6-18W	18W	Ø170x124	1890lm	0.49	12PCS
JDL115-8-25W	25W	Ø213x129	2930lm	0.80	12PCS

CCT — 3000K 4000K 5000K 5700K Finish — White Black Silver

# JPD05A/B Downlight

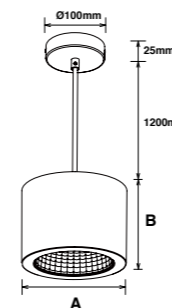

JPD05A/B SMD pendant downlight series with 3 CCT in 1 lamp optional, slide switch for color selection is good for commercial project requirement. 60° beam angle with specular reflector can reach UGR<19.

### Reflector



- ▶ 60° 90°
- ▶ IP20 UGR<19
- ▶ DIM SLIDE SWITCH 3 in 1
- ▶ AC 100-277V AC 200-240V PF≥0.9 CRI≥80
- ▶ SAA RoHS CE



Code	Watt	Size(AxBmm)	Lumen(±5%)	N.W/pc(kgs)	Q'ty/CTN
JPD05-4-13W	13W	Ø143x110	1460lm	0.65	12PCS
JPD05-6-18W	18W	Ø170x123	1890lm	0.83	12PCS
JPD05-8-25W	25W	Ø213x127	2930lm	1.06	12PCS

CCT — 3000K 4000K 5000K 5700K Finish — White Black Silver



# JPD322 Downlight

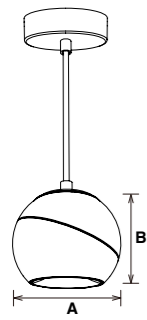

JPD322 adopts high lumen COB chip. It is suspension version and JPD322A is track suspending for option. AL6063 aluminum lamp body provides excellent heat dissipation. Beam angle 36 and 60 degree adjustable. Track suspension with DALI dimmable is available.

- ▶ 36° 60° IP20
- ▶ DIM
- ▶ AC 220-240V PF ≥ 0.9 CRI ≥ 80
- ▶ RoHS CE

Code	Watt	Size(AxBxCmm)	Lumen(±5%)	N.W/pc(kgs)	Q'ty/CTN
JPD322-10W	10W	Ø120x98	900lm	0.95	12PCS
JPD322-15W	15W	Ø120x98	1400lm	0.95	12PCS
JPD322A-10W	10W	Ø120x98	900lm	0.90	12PCS
JPD322A-15W	15W	Ø120x98	1400lm	0.90	12PCS
JPD322A-10W-DA	10W	Ø120x98	900lm	1.00	12PCS
JPD322A-15W-DA	15W	Ø120x98	1400lm	1.00	12PCS

CCT — 2700K 3000K 4000K 5000K

Finish — White Black



LED Downlight  
Surface mounted &  
Pendant Series

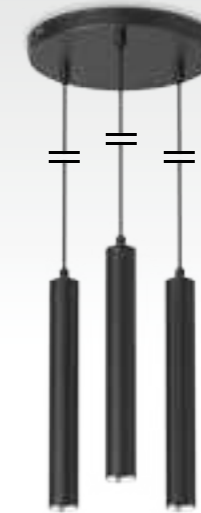
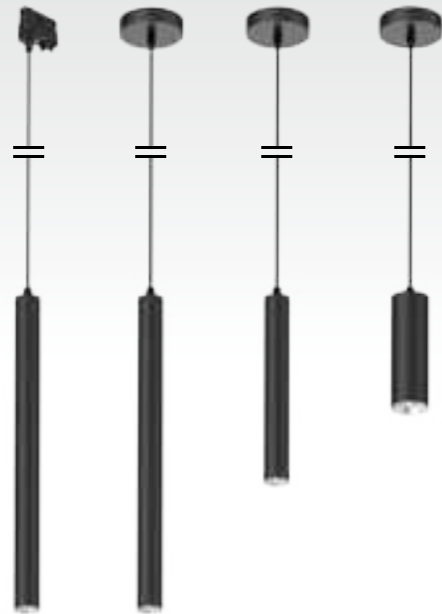

# JPD12 Downlight

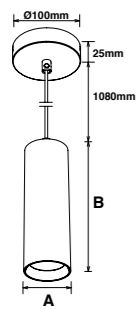

JPD12 pendant spot light with slim and stylish appearance is good for home and commercial project requirement. It offers a wide choice of beam angles 15°/24°/36°/60° for optional. Different colors of trim is optional for creating diversified light atmosphere.

- ▶ Beam angles: 15°, 24°, 36°, 60°
- ▶ IP20, UGR<19
- ▶ AC 200-240V, CRI≥80, CRI≥90, CRI≥97
- ▶ SAA, RoHS, CE

Code	Watt	Size(AxBmm)	Lumen(±5%)	N.W/pc(kgs)	Q'ty/CTN
JPD12-5W	5W	Ø39x300	500lm	0.51	18PCS
JPD12-5W	5W	Ø39x500	500lm	0.65	18PCS
JPD12-10W	10W	Ø58x180	1000lm	0.54	12PCS

CCT — 2700K 3000K 4000K 5000K Finish — White Black Silver

# JPD12B Downlight

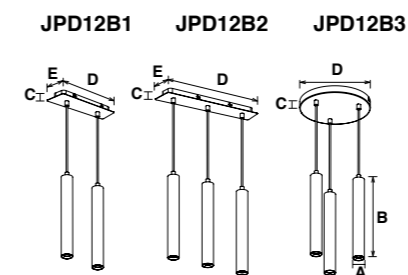

JPD12B cylinder large pendant is a high-performance LED luminaire that is ideal for commercial and residential applications. It offers a wide choice of beam angles 15°/24°/36°/60° for optional. Different colors of trim is optional for creating diversified light atmosphere.

- ▶ Beam angles: 15°, 24°, 36°, 60°
- ▶ IP20, UGR<19
- ▶ AC 200-240V, CRI≥80, CRI≥90, CRI≥97
- ▶ RoHS, CE



Code	Watt	Size(AxBxCxDxEmm)	Lumen(±5%)	N.W/pc(kgs)	Q'ty/CTN
JPD12B1-10W	10W	Ø39x300x26x250x80	1100lm	1.20	6PCS
JPD12B2-15W	15W	Ø39x300x26x370x80	1650lm	1.80	6PCS
JPD12B3-15W	15W	Ø39x300x25xØ240	1650lm	1.80	6PCS

CCT — 2700K 3000K 4000K 5000K Finish — White Black Silver