

Technical Application
Guide for JIBE
LED Ceiling light

JAL45-20-35W

JAL45-20-35W-D

Introduction



With high performance(Dimmable, Non-dimmable, DALI Dimmable, Emergency, Sensor, Sensor+Emergency). Easy to install: labor-saver(quick terminal block design) , Connect in series(Opening wiring and concealed wiring are optional). IP65, IK10. Easier maintenance, as the driver can be replaced easily, different standard drivers in the market can be matched.

- Up to 70% energy saving compared to standard CFL
- Long lifetime of 50,000 hours
- Triac dim, 0-10V dim, DALI dim
- 120° wide beam angle
- CCT: 3000K 4000K 5000K 5700K
- No UV/IR light
- Environment friendly, without Mercury or any other hazardous substances

Application notes

- IP65 both for indoor and outdoor use
- Professional electrician for installation only
- Switch off before installation
- Do not touch when in use
- Keep away from hot steam and corrosive gas

Application Areas

It is designed for general lighting applications in office, supermarket, shop, school, hotel, etc. It is also widely used for public areas, such as stairway, lobby, reception, corridors etc.

Certificate

CE RoHS



Product Information

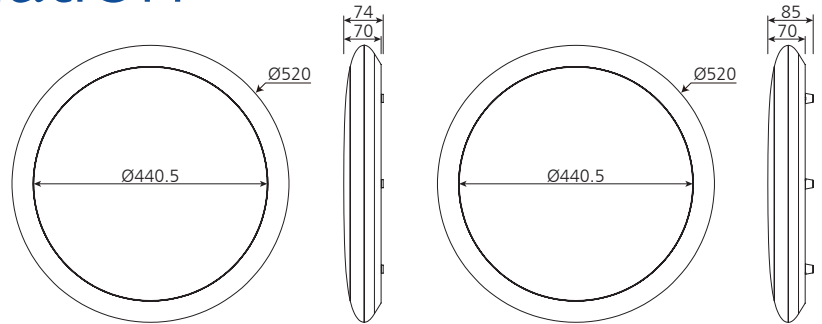

Technical Specifications

Model	Voltage	Power	Power Factor	Lumen (±5%)	CCT	Beam angle	Lifespan	CRI	Dimmable	Dimension
JAL45-20-35W	AC230V	35W	≥0.9	3320	3000K	120°	50000h	≥80	No	Ø520*85mm
				3670	4000K					
				3360	5000K					
				3390	5700K					
JAL45-20-35W-D	AC230V	35W	≥0.9	3250	3000K	120°	50000h	≥80	Yes	Ø520*85mm
				3600	4000K					
				3320	5000K					
				3360	5700K					

Driver data Sheet

Driver data	DIM	Non-dim
Input rated Voltage	AC230V	AC230V
Frequency	50Hz	50/60Hz
Input Voltage	AC200-240V	AC220-240V
Efficiency	≥83%	≥86%
No load wattage	≤1W	≤1W
Total load Wattage	35W±5%	35W±5%
Power Factor	≥0.9	≥0.9
Rated input current	≤0.2A	≤0.18A
Full load output Voltage	DC30-38V	DC28-40V
Rated output current	880mA	940mA
Output current range	880mA±5%	940mA±5%
Power tolerance	±5%	±5%
Current output tolerance	±5%	±5%
Dimming range	8%-100%	—
Dimmer	Triac dimmers	—
Short circuit protection	PASS	PASS
Over voltage protection	PASS	PASS
Over temperature protection	PASS	PASS
THD	≤20%	≤20%
Withstand voltage	AC3750V	AC3750V

Fixture Compatibility

Rated Wattage	Electrical Classification	Ingress Protection	Operating Temp	Operating Humidity	Storage Temp
35W	II	IP65	-20°C~45°C	0~90%	-20°C~65°C

Spectral Distribution

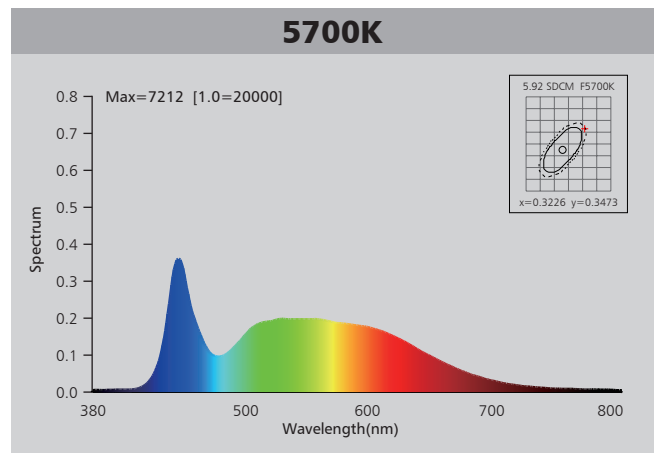
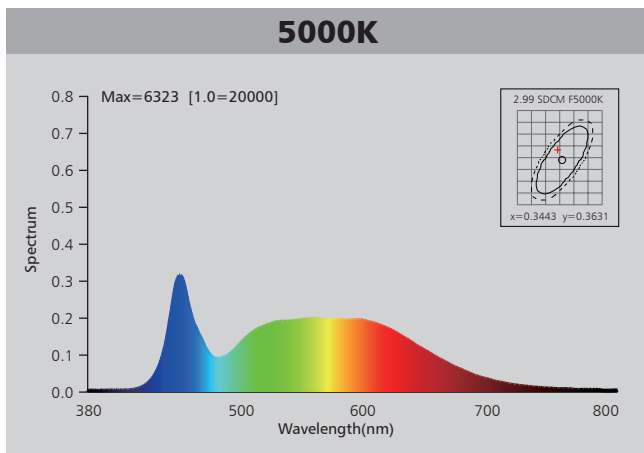
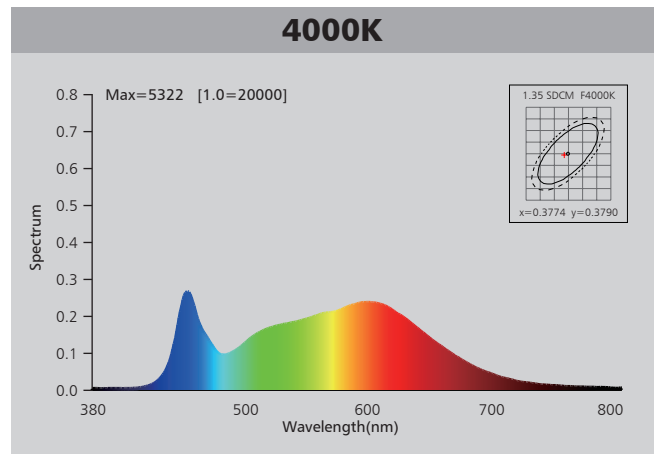
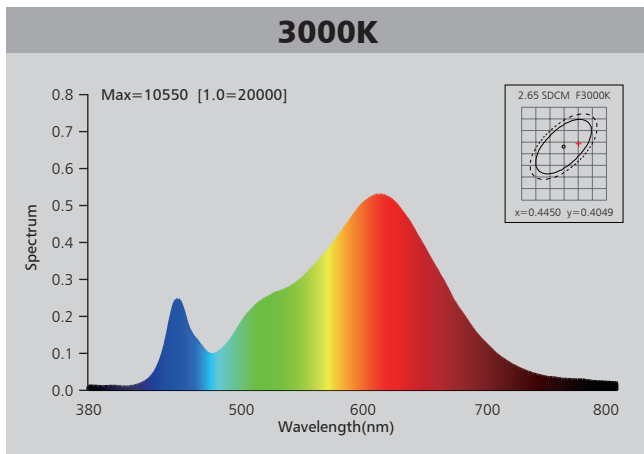

Photometric Diagram

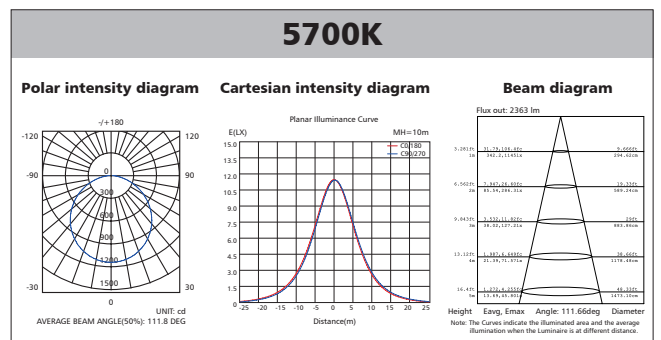
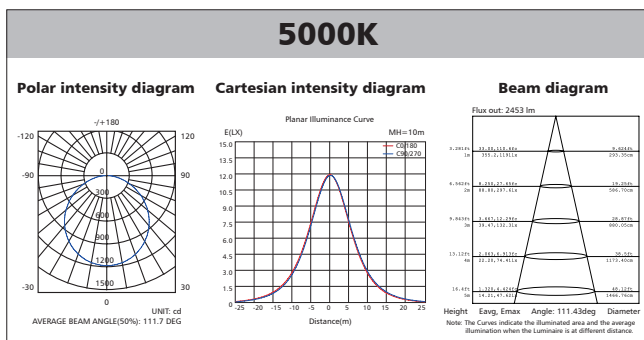
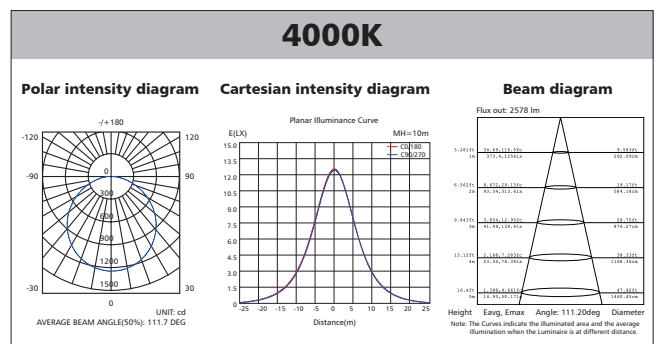
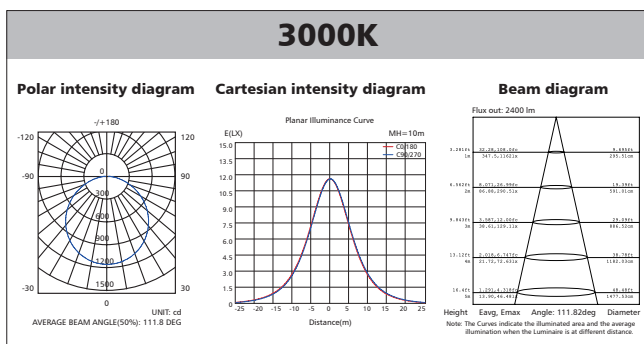

Polar Diagram Comparison

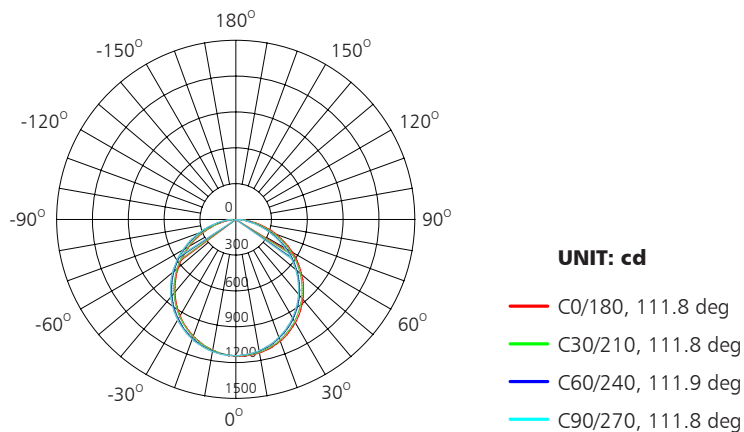

AVERAGE BEAM ANGLE (50%): 111.8 DEG

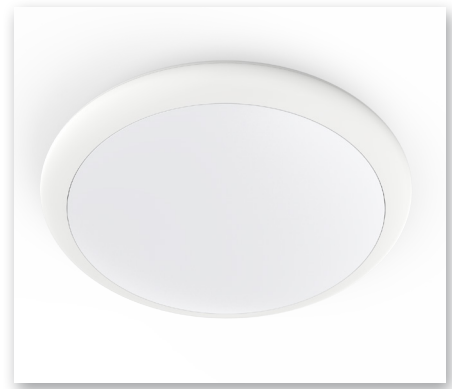

Driver lifetime & LED light decay rate

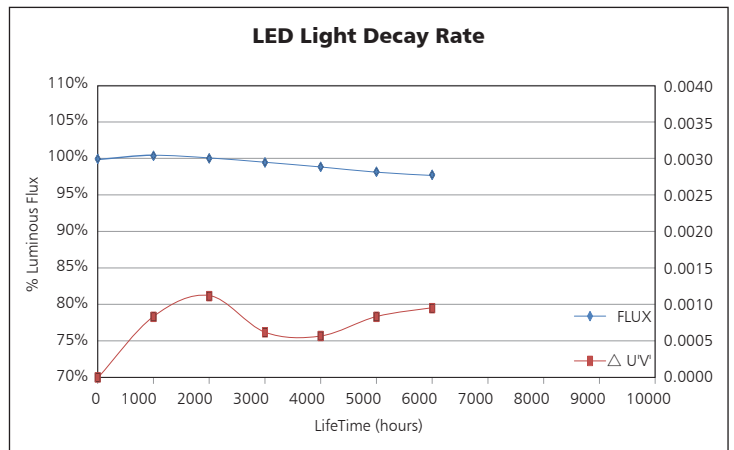
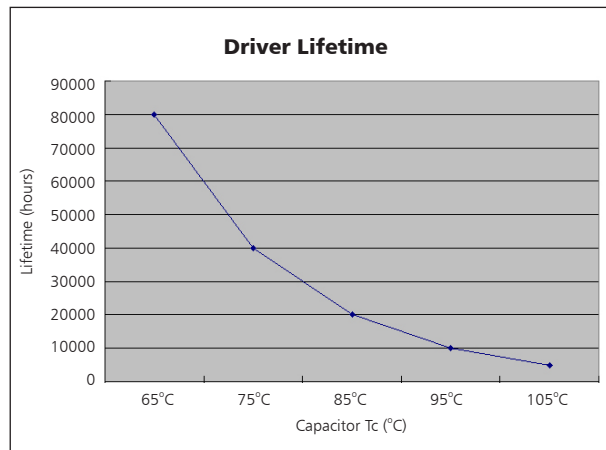

Temperature

- The testing is operated at 25°C
- The lifetime of capacitor, minimum of 5,000 hours if operated at 105°C, will be doubled whenever the temperature drops 10°C
- The highest withstand temperature of IC, MOS could be 120°C
- The highest withstand temperature of LED junction temperature is 150°C

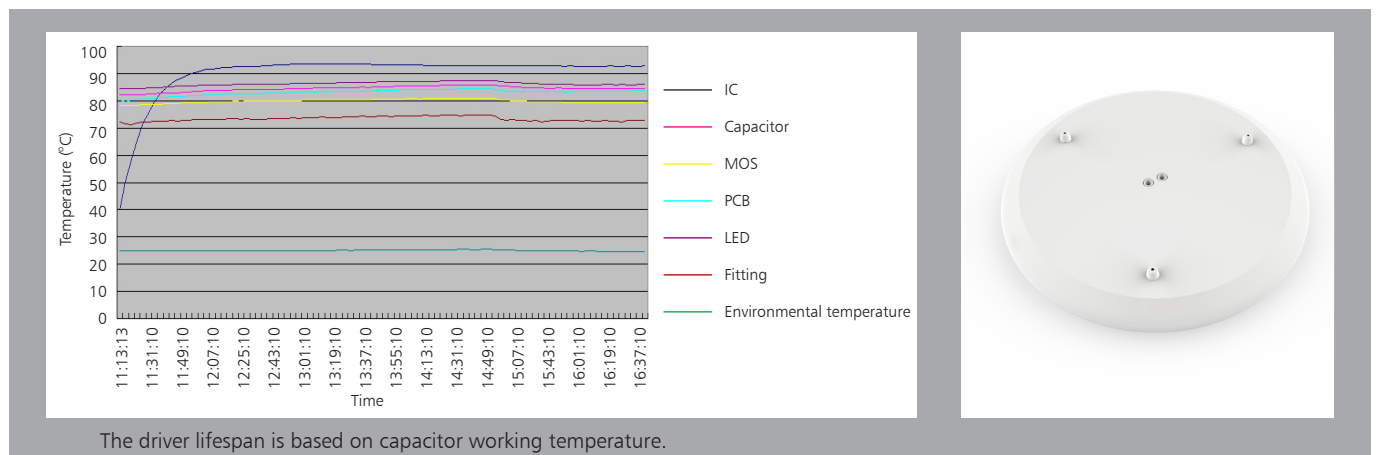

Installation

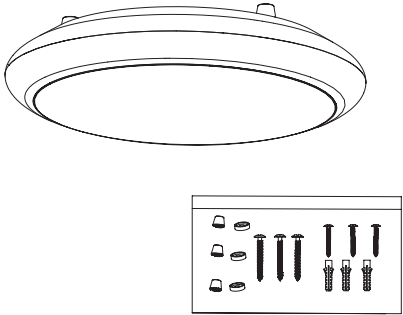
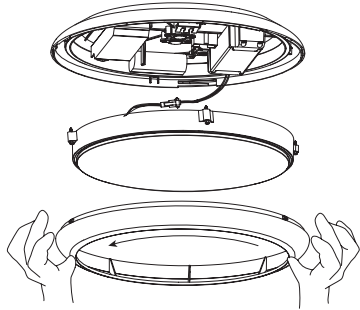
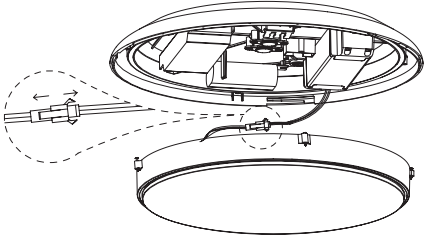
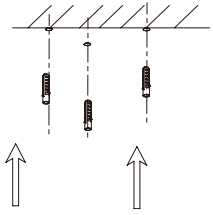
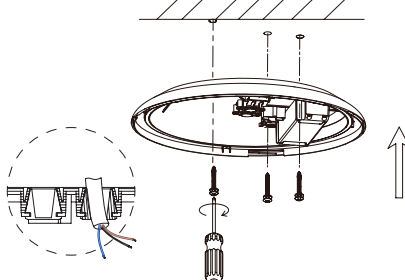
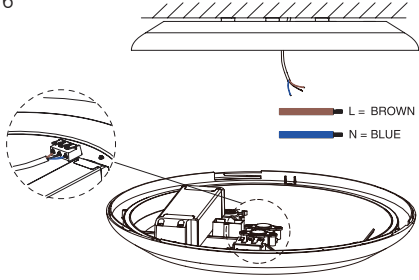
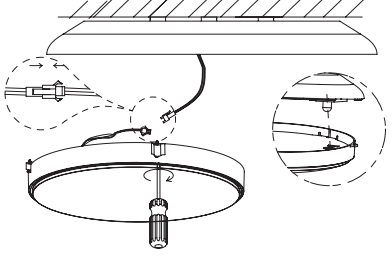
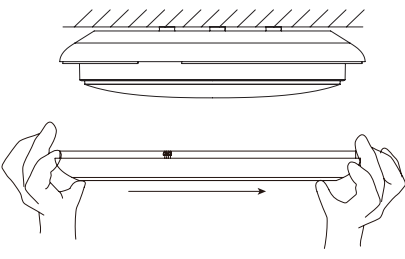
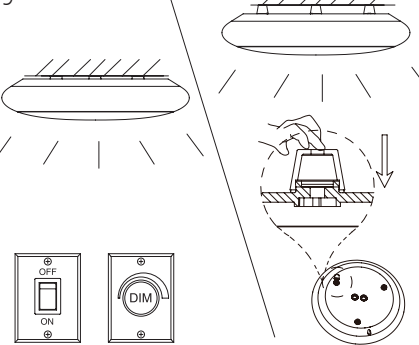
<p>1</p>  <p>Take out accessory pack.</p>	<p>2</p>  <p>Unscrew the front frame anticlockwise and take it out, make the frame, diffuser and back housing separately.</p>	<p>3</p>  <p>Disconnect the connection plug.</p>
<p>4</p>  <p>Put the plastic anchor into the ceiling.</p>	<p>5</p>  <p>Make the input wires through entrance hole and waterproof bushing, cover the screws with waterproof washer, fix the back housing by these screws.</p>	<p>6</p>  <p>Connect the wires to the block through the reliefs.</p>
<p>7</p>  <p>Settle the male and female connectors well and fix the diffuser cover on the back housing by screws.</p>	<p>8</p>  <p>Match the gaps for each part and rotate the frame clockwise.</p>	<p>9</p>  <p>Installation finished, turn on the switch.</p>

Packaging Information

	SIZE(CM)	N.W/pc (KGS)	G.W.(KGS)	Q'TY(PCS)
Carton	61.5*58*58	2.4	20.3	6

	CTNS	Q'TY(PCS)	VOLUME(CBM)
20" standard container	130	780	28
40" standard container	260	1560	56

