

Technical Application Guide
Jibe LED Downlight JCL102

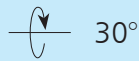

Introduction



JCL102 LED recessed downlight adopts super slim and compact design, perfectly suitable for the narrow ceiling installation. IP65 rating front cover design, suitable for damp environment. Traditional diamond plaited surface lens design ensures the high light transmittance and uniform lighting output. T-shape heat sink greatly increases the radiation area and improves cooling efficiency. The fitting could be rotated from 0 to 30 degree in horizontal direction, which can expand the illumination area.

- Up to 70% energy saving compared to standard CFL
- Long lifetime of 40,000 hours
- Triac dim, 0-10V dim, DALI dim
- 36°/60° wide beam angle
- Ø68-72mm cutout
- CCT: 2700K 3000K
4000K 5000K
- No UV/IR light
- Environment friendly, without Mercury or any other hazardous substances

Application notes

- Professional electrician for installation only
- Switch off before installation
- Do not touch when in use
- Keep away from hot steam and corrosive gas

Application Areas

It is designed for general lighting applications in office, supermarket, shop, school, hotel, etc. It is also widely used for public areas, such as stairway, lobby, reception, corridors etc.

Certificate

CE RoHS SAA



Product Information

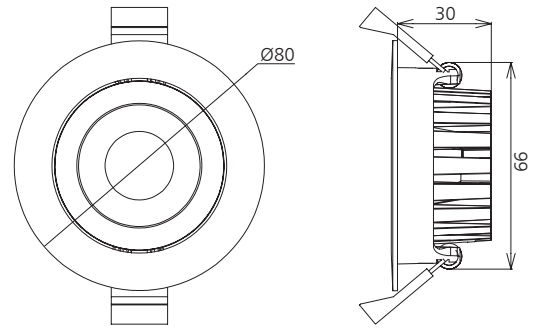

Technical Specifications

Model	Voltage	Power	Power Factor	Lumen (±5%)	Beam angle	CCT	Lifespan	CRI	Dimmable	Dimension
JCL102A-2.5-5W	AC230V	5W	≥0.9	465	36°/60°	2700K	40000h	≥80	No	Ø80*30mm cutout Ø68-72mm
JCL102A-2.5-5W	AC230V	5W	≥0.9	480	36°/60°	3000K	40000h	≥80	No	Ø80*30mm cutout Ø68-72mm
JCL102A-2.5-5W	AC230V	5W	≥0.9	530	36°/60°	4000K	40000h	≥80	No	Ø80*30mm cutout Ø68-72mm
JCL102A-2.5-5W	AC230V	5W	≥0.9	530	36°/60°	5000K	40000h	≥80	No	Ø80*30mm cutout Ø68-72mm
JCL102A-2.5-5W-D	AC230V	5W	≥0.9	460	36°/60°	2700K	40000h	≥80	Yes	Ø80*30mm cutout Ø68-72mm
JCL102A-2.5-5W-D	AC230V	5W	≥0.9	475	36°/60°	3000K	40000h	≥80	Yes	Ø80*30mm cutout Ø68-72mm
JCL102A-2.5-5W-D	AC230V	5W	≥0.9	525	36°/60°	4000K	40000h	≥80	Yes	Ø80*30mm cutout Ø68-72mm
JCL102A-2.5-5W-D	AC230V	5W	≥0.9	520	36°/60°	5000K	40000h	≥80	Yes	Ø80*30mm cutout Ø68-72mm
JCL102A-2.5-5W	AC230V	5W	≥0.9	345	36°/60°	2700K	40000h	≥90	No	Ø80*30mm cutout Ø68-72mm
JCL102A-2.5-5W	AC230V	5W	≥0.9	370	36°/60°	3000K	40000h	≥90	No	Ø80*30mm cutout Ø68-72mm
JCL102A-2.5-5W	AC230V	5W	≥0.9	410	36°/60°	4000K	40000h	≥90	No	Ø80*30mm cutout Ø68-72mm
JCL102A-2.5-5W	AC230V	5W	≥0.9	380	36°/60°	5000K	40000h	≥90	No	Ø80*30mm cutout Ø68-72mm
JCL102A-2.5-5W-D	AC230V	5W	≥0.9	345	36°/60°	2700K	40000h	≥90	Yes	Ø80*30mm cutout Ø68-72mm
JCL102A-2.5-5W-D	AC230V	5W	≥0.9	365	36°/60°	3000K	40000h	≥90	Yes	Ø80*30mm cutout Ø68-72mm
JCL102A-2.5-5W-D	AC230V	5W	≥0.9	400	36°/60°	4000K	40000h	≥90	Yes	Ø80*30mm cutout Ø68-72mm
JCL102A-2.5-5W-D	AC230V	5W	≥0.9	375	36°/60°	5000K	40000h	≥90	Yes	Ø80*30mm cutout Ø68-72mm

Driver data Sheet

Driver data	DIM	Non dim
Input rated Voltage	AC230V	AC230V
Frequency	50Hz	50Hz
Input Voltage	AC200-240V	AC200-240V
Efficiency	≥78%	≥78%
Total load Wattage	5W±0.5W	5W±0.5W
Power Factor	≥0.9	≥0.9
Rated input current	≤0.028A	≤0.03A
Full load output Voltage	DC28-38V	DC28-40V
Rated output current	130mA	130mA
Output current range	130mA±5%	130mA±5%
Power tolerance	±5%	±5%
Current output tolerance	±5%	±5%
Dimming range	8%-100%	—
Dimmer	Triac dimmers	—
Short circuit protection	PASS	PASS
Over voltage protection	PASS	PASS
Over temperature protection	PASS	PASS
THD	≤20%	—
Withstand voltage	AC3750V	AC3750V

Fixture Compatibility

Rated Wattage	Electrical Classification	Ingress Protection	Operating Temp	Operating Humidity	Storage Temp
5W	II	IP65	-20°C~45°C	0~90%	-20°C~65°C

Spectral Distribution

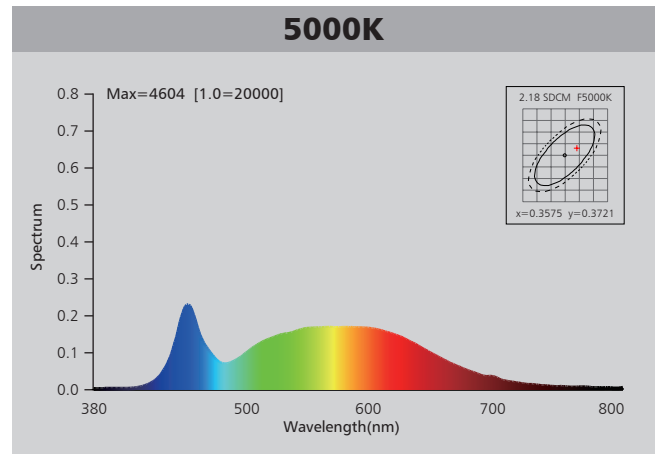
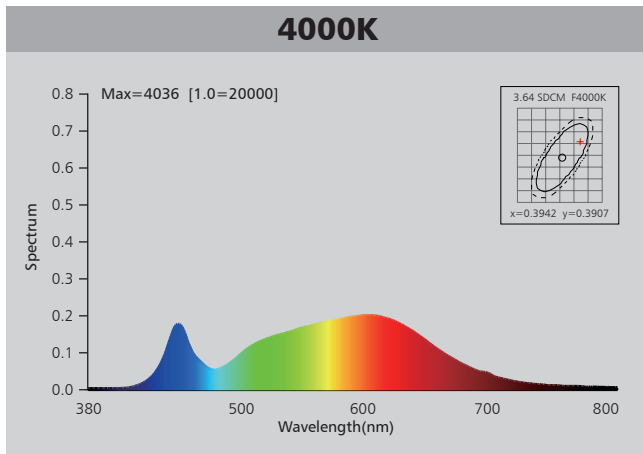
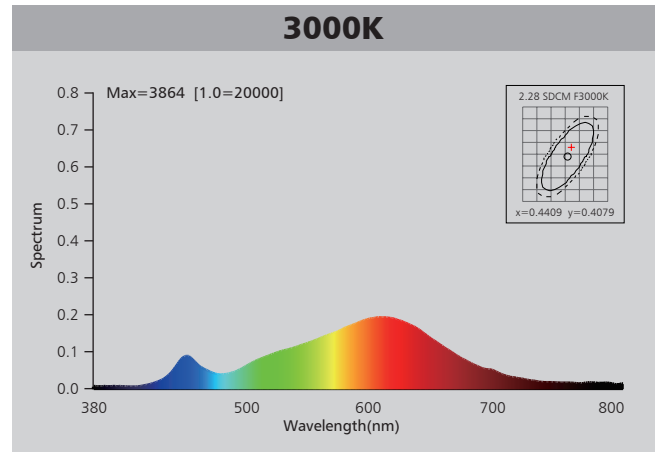
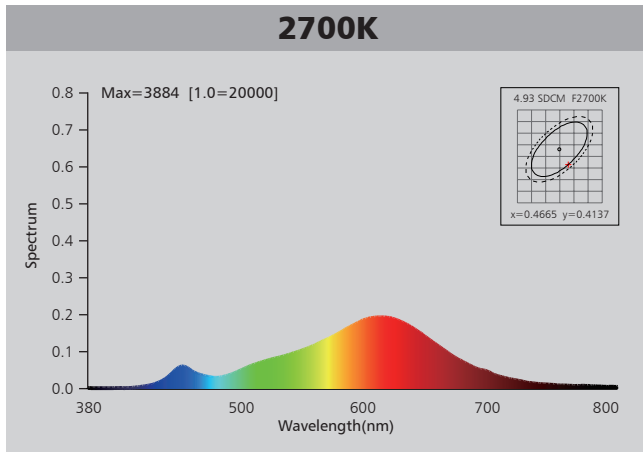

Photometric Diagram

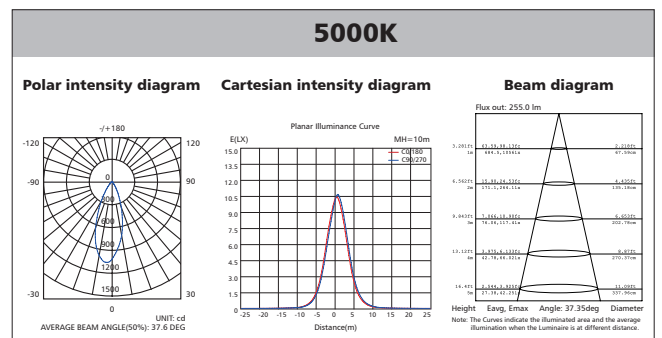
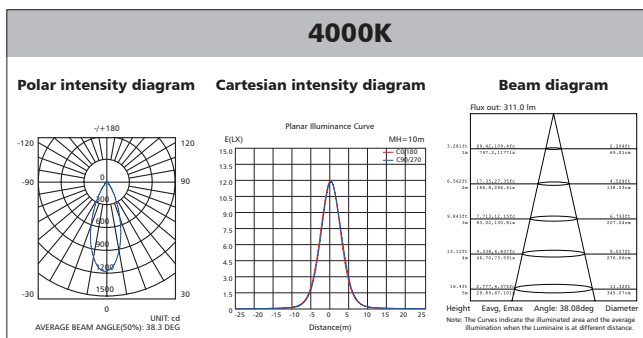
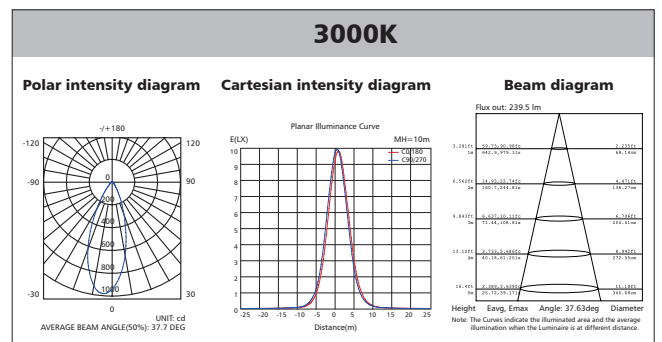
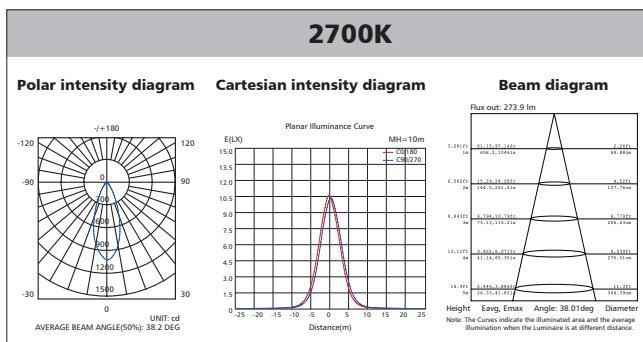

Polar Diagram Comparison

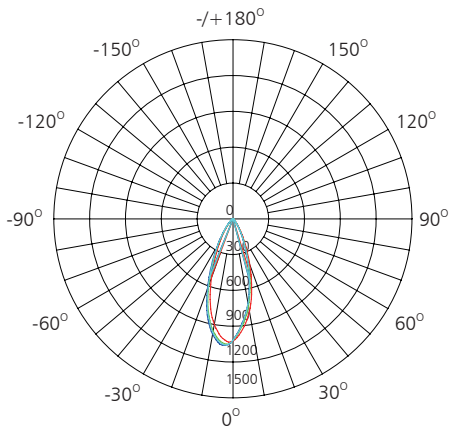

UNIT: cd

- C0/180, 37.9 deg
- C30/210, 37.6 deg
- C60/240, 37.4 deg
- C90/270, 37.3 deg



AVERAGE BEAM ANGLE (50%): 37.6DEG

Driver lifetime & LED light decay rate

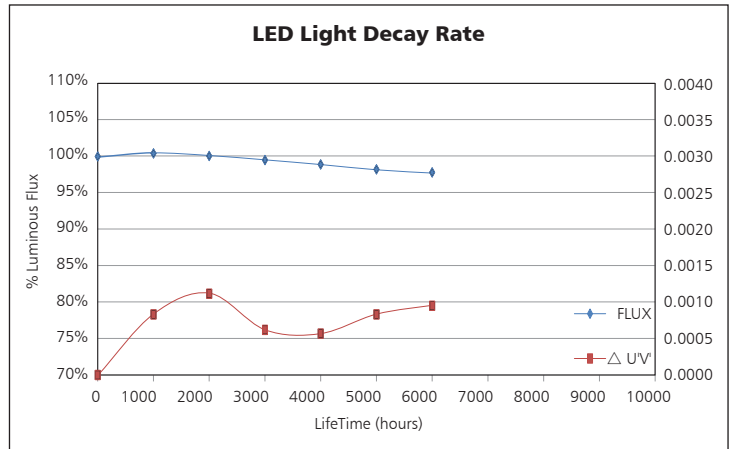
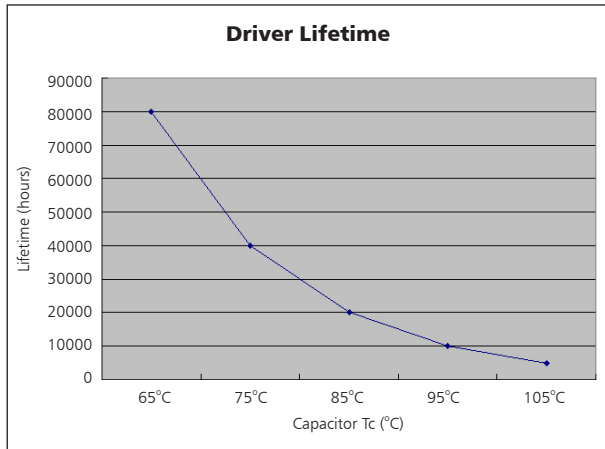

Temperature

- The testing is operated at 25°C
- The lifetime of capacitor, minimum of 5,000 hours if operated at 105°C, will be doubled whenever the temperature drops 10°C
- The highest withstand temperature of IC, MOS could be 120°C
- The highest withstand temperature of LED junction temperature is 150°C

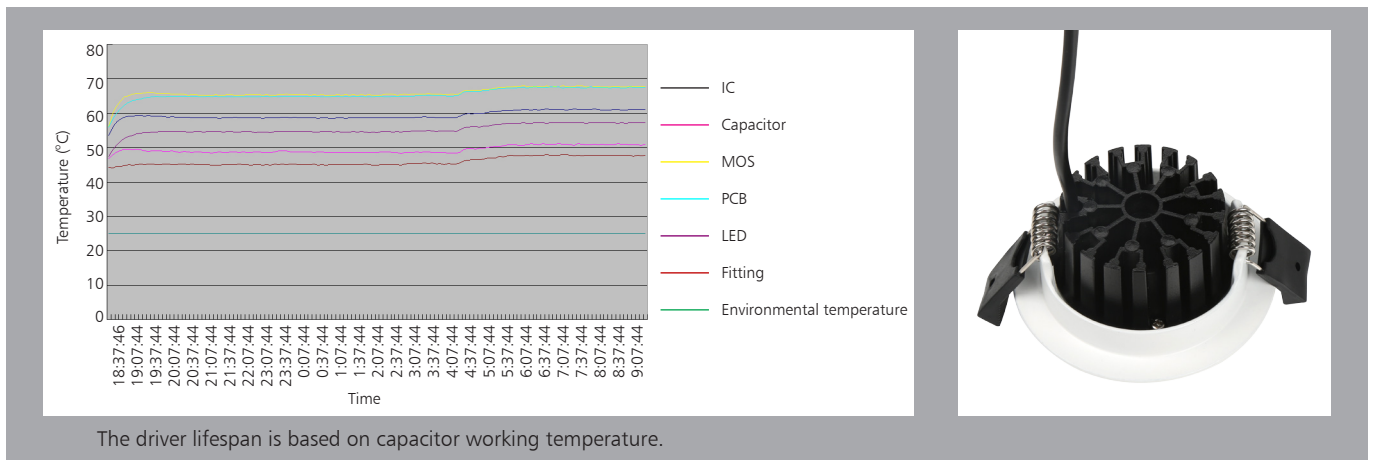

Installation

Install requirements	
A-gap above the fitting	25mm
B-gap to the building material	25mm
C-gap to the thermal insulation	50mm

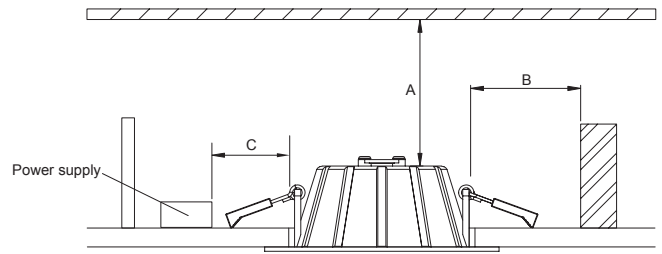

1. Open a hole according to the cutout size of led downlight.

2. Use screw-driver to open the driver terminal cover, feed the main AC wire L. N. in terminal block respectively, then fix the cover back.

3. Connect the downlight with driver, hold back the spring clip then push the downlight into the hole.

4. Make sure the downlight fixed tightly in ceiling, turn on the power (Fig 1).

Packaging Information

	SIZE(CM)	N.W/pc (KGS)	G.W.(KGS)	Q'TY(PCS)
Carton	52.5*52.5*15	0.24	15	50

	CTNS	Q'TY(PCS)	VOLUME(CBM)
20" standard container	660	33000	28
40" standard container	1320	66000	56

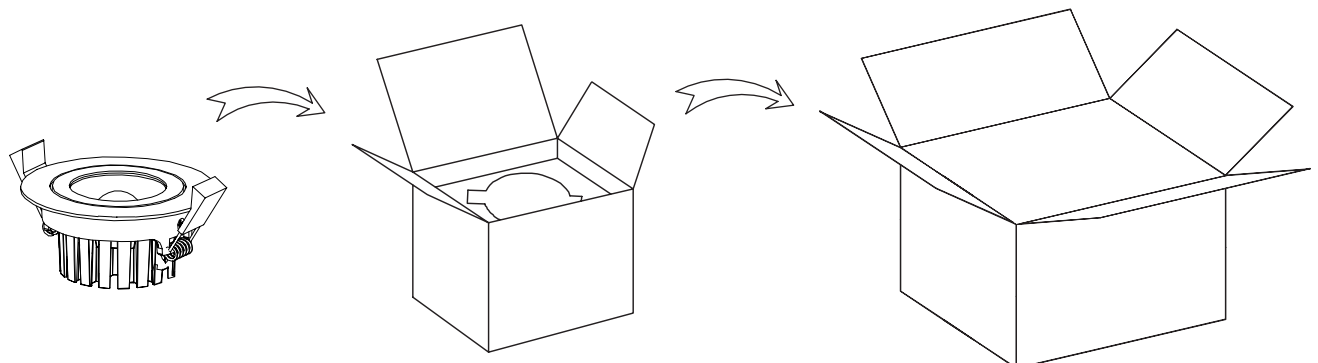



LED THERE BE LIGHT

© 2019 Jibe Lighting - all rights reserved

Jibe reserves the right to alter material, dimensions and characteristics without prior notice.

Read installation instructions carefully. Technical information on the installation instruction has precedence over the information in the brochure.

Our general terms and conditions shall apply notwithstanding any stipulation to the contrary to all the orders and agreements with Jibe.

You can obtain a copy of these conditions on demand.

For latest information and specifications of the full product range

visit www.jibe.lighting

JIBE LIGHTING — HEADQUARTERS
Hogebrinkerweg 14V - 3871 KN Hoevelaken
Netherlands Tel: +31 (0)33 844 7111
info@jibe.lighting - www.jibe.lighting