

**LINEAR LIGHTING SERIES**

# **LONGUM LINK**

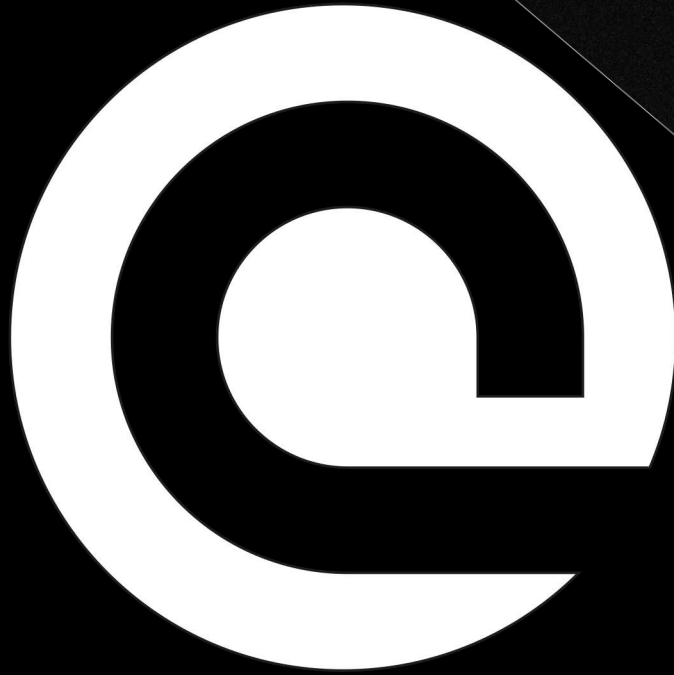
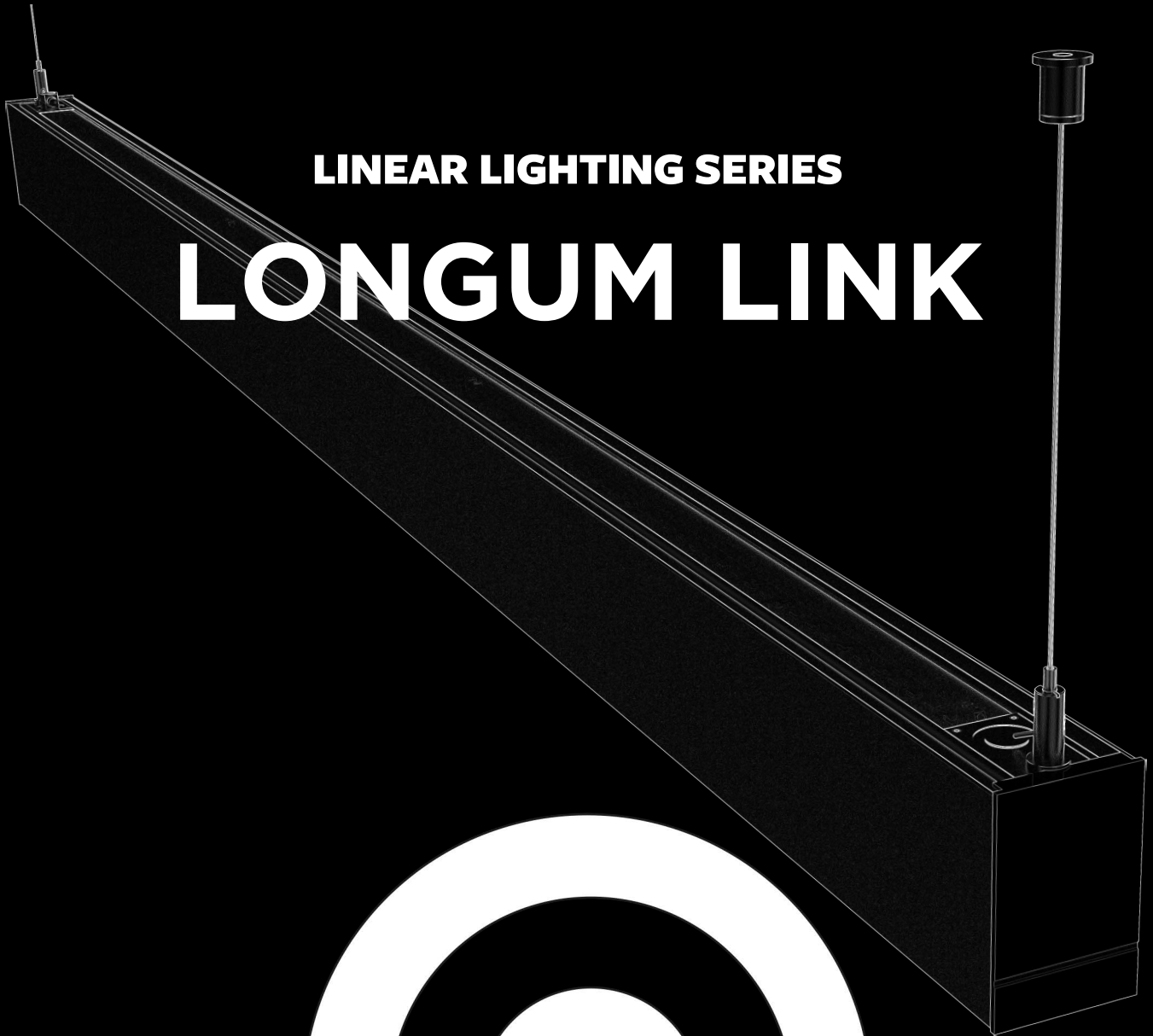

# **ساز**

# LINEAR LIGHTING SERIES LONGUM LINK



## ABOUT

---

### **LONGUM IS THE LATEST TECHNOLOGY IN OFFICE LINE LIGHTING**

Office art by introducing a sleek and slim designed intelligent line light that is ready for the future of intelligent buildings. Anodized Aluminium, Tunable white downlight with no glare, and amazing blue uplight creating a future like atmosphere.

# Daylight Rythm

TRUE-TO-LIFE COLOR



## BIOLOGICAL CLOCK IN HYPERDRIVE

Natural light is in constant change as it illuminates our life. The color and intensity of light controls our biological rhythm. While common LED lighting do not care about your rhythm, we at Jibe Lighting do everything we can to keep you healthy and energetic. Due to our innovative technologies, our lighting mimics the natural rhythm, stimulating you well-being and keeps you feeling alert and fresh troughout the entire day. Our enhanced technology creates varying combinations of warm and cool lighting, decreasing melatonin levels during your "normal" 15:00 dip, and smoothly adding healthy melatonin levels at the end of the day. Also, our software allows biohythm adjustments for the night shifts or specific changes in the light for special tasks and needs.

Our researchers found numerous benefits of maintaining the natural daylight rhythm:

- Increased emotional stability
- Decreases the change of burnouts
- Less absence of employees
- Helps with sleeping problems
- Increased productivity
- Less errors during tasks
- Increased motivation and involvement
- Increased safety and productivity in the workplace
- Longer periods of concentration.
- Improved learning with excellent results.

**" Health lies in healthy circadian habits "**

- Satchin Panda, PhD scientist and researcher at the Salk Institute in San Diego

# LINEAR LIGHTING SERIES LONGUM LINK



## FEATURES

- Saving energy: up to 150 lm/w luminous efficiency
- Saving installation costs: Modularization, tool-free
- Saving maintenance costs: 5 years warranty
- Controllable: DALI dimming
- Linkable system: Seamless connection
- Multiple beam angle: 30°, 50°, 80°, 120°, Double 25°, Asymmetric Left/Right 25°
- Tunable white downlight. Low UGR
- Dimmable uplight

**Up**



**Down**

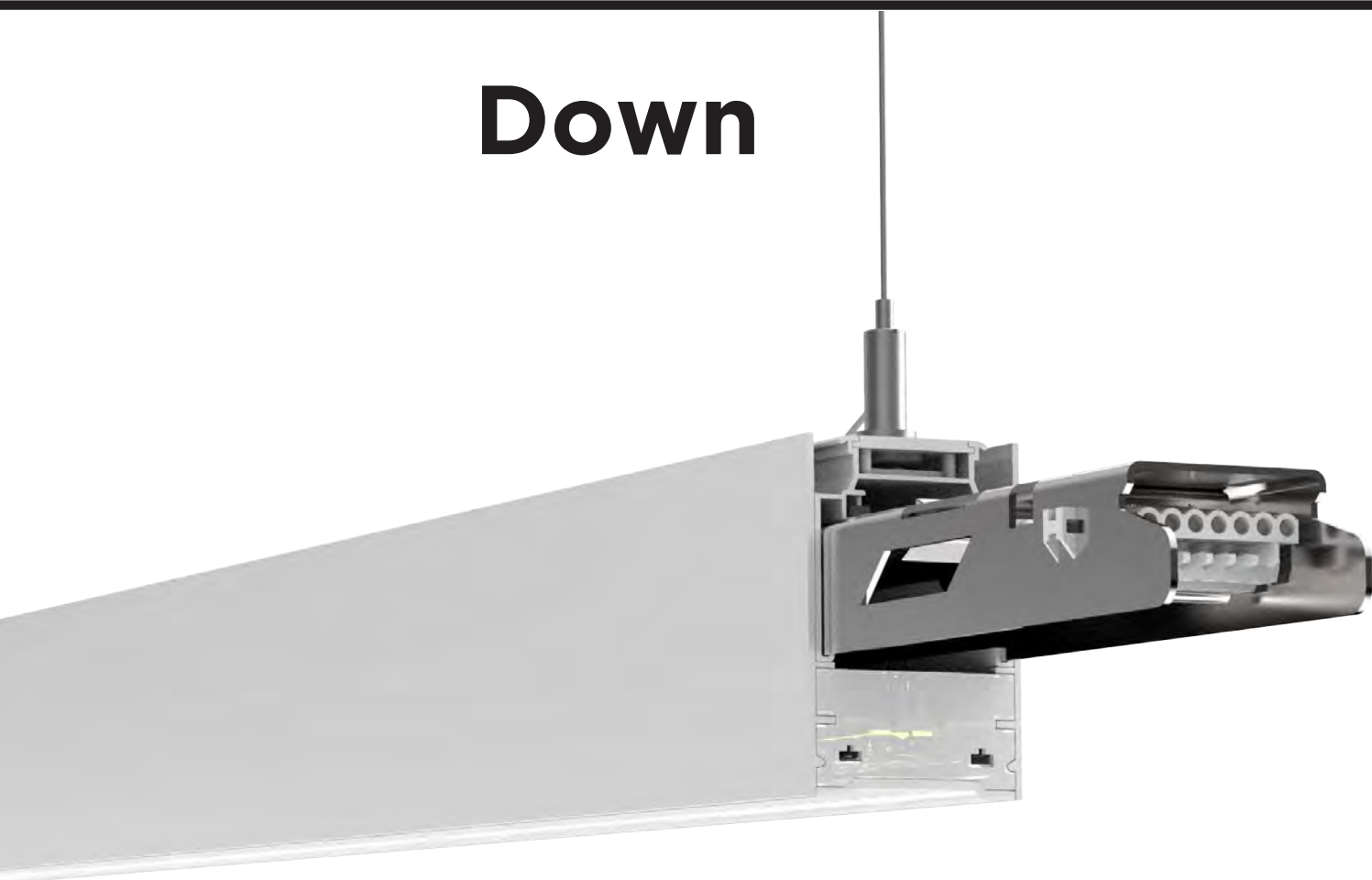

# Linking Fixtures

CREATING ART WITH LIGHT

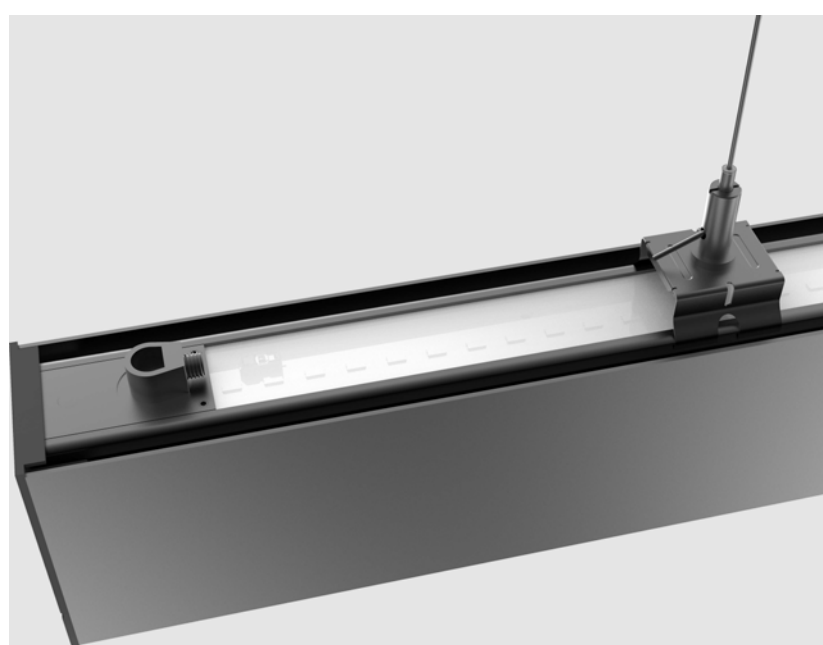
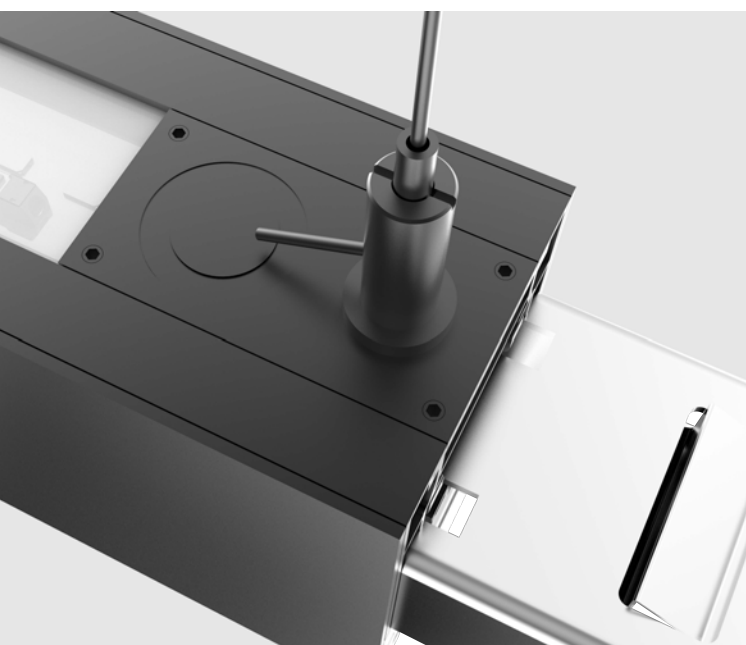

**MOVABLE OR FIXED  
SUSPENSION RODS,  
NOT JUST ANOTHER  
LIGHTING FIXTURE.**

Free choice of fixed or movable suspension clips in order to prevent unwanted suspension mounting in precious (climate) ceilings.



# Technology

CREATING ART WITH LIGHT

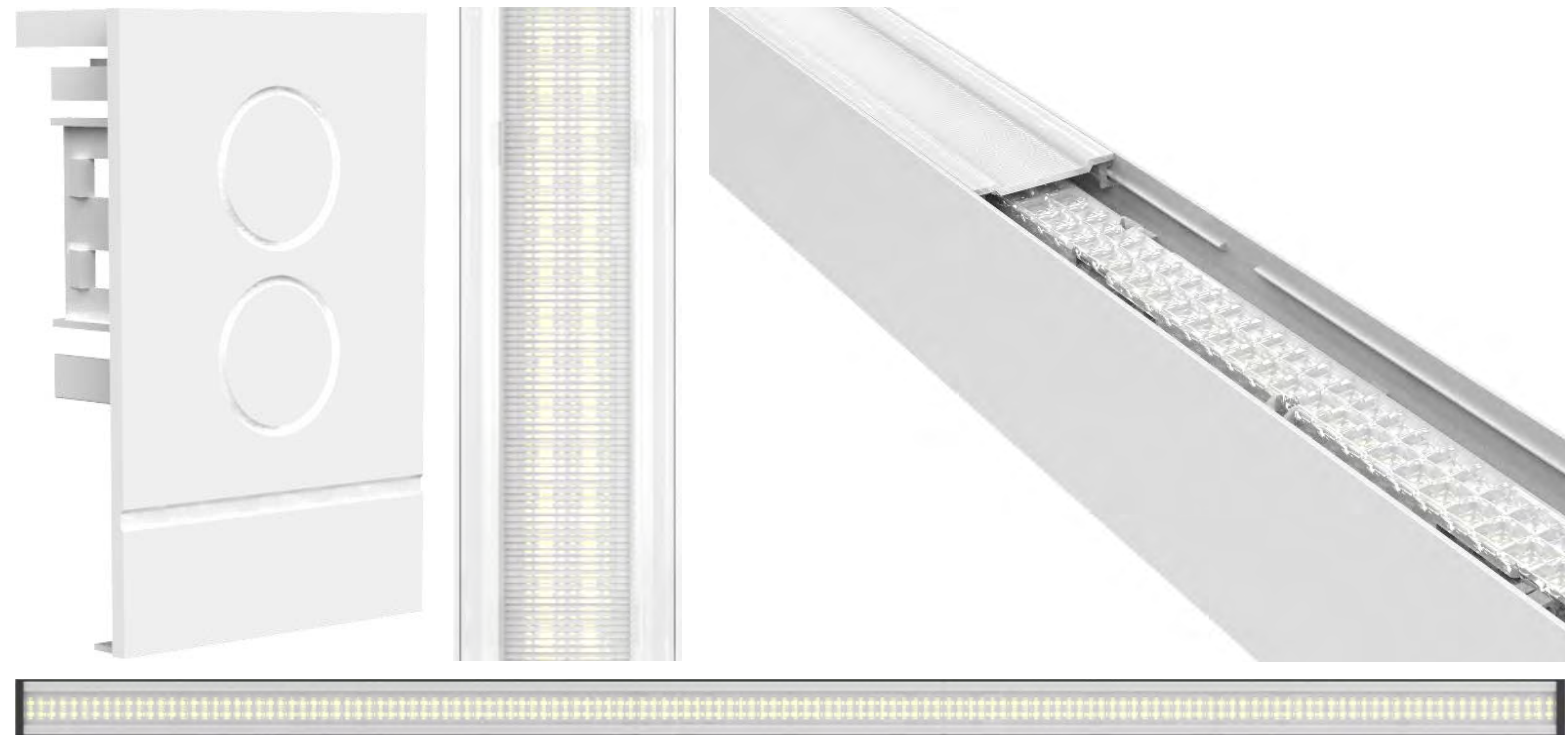

## WHERE ART AND TECHNOLOGY COME TOGETHER

The Longum will make your Return on Investment count. Because of it's the state-of-the-art LED and lens technology, a very high 150 lumen per watt can be achieved. High lumen per watt means low energy consumption and longer LED lifetime. Available in different lengths thereby avoiding unnecessary cabling, connectors and drivers to keep the cost of ownership low. All LEDs are placed on a Metal Core PCB allowing them to cool better and faster for less color shift and light depreciation.

For the Downlight, 2 colors of LEDs have been placed which can be controlled seperately. 3000K - 6500K (tunable white) allowing for a full range of colorshift between these two colors. For the uplight dimmable blue LEDs have been placed to create an amazing ambiance onto the ceiling. The control gears are Dali DT8 enabled and allow digital adressing and bus control that includes dimming, tunable white control, lamp and device status, running hours, power-on level, system-failure level etc.

# SUSPENSION CABLES

WORTH TALKING ABOUT

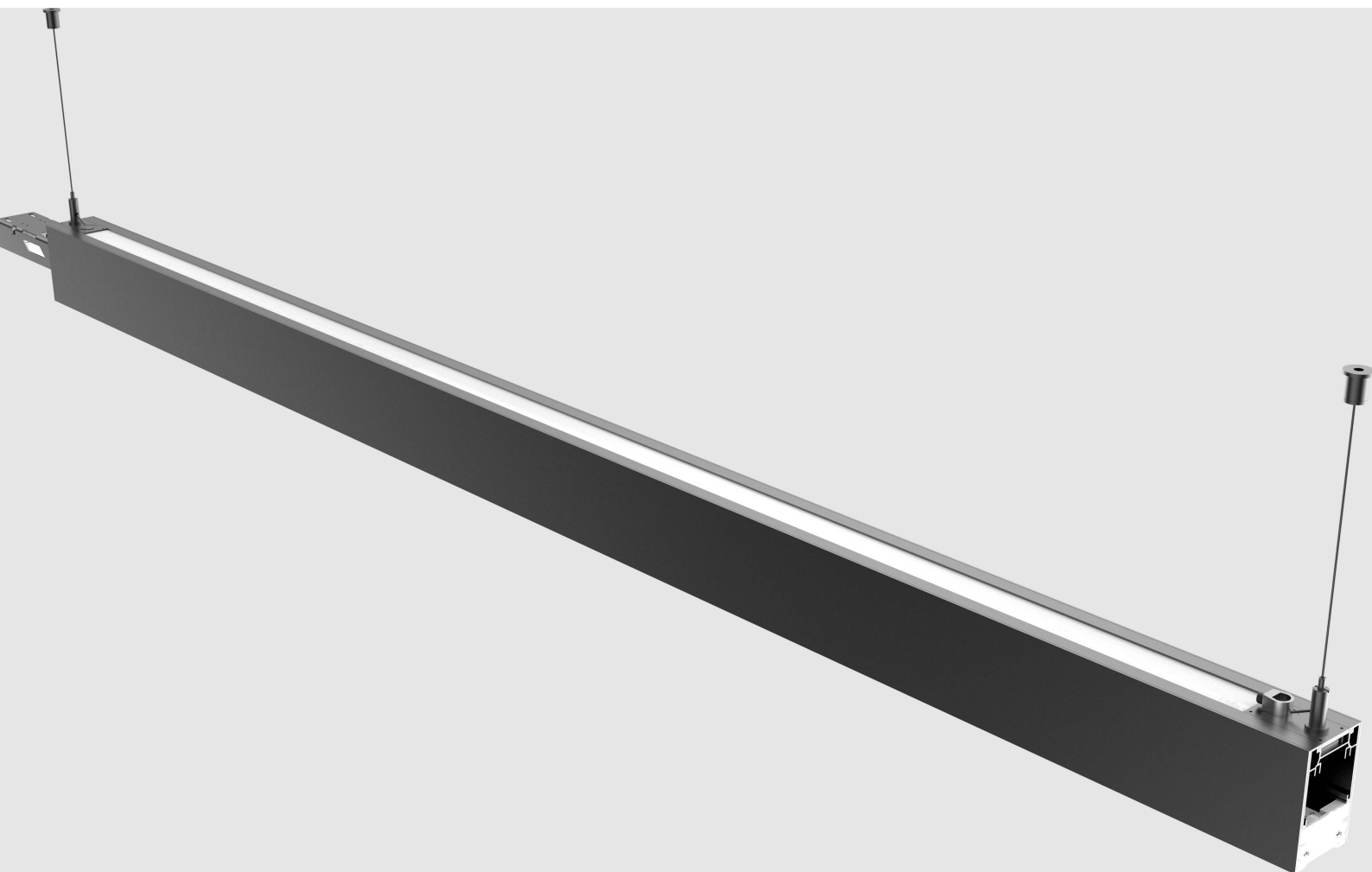

## **LONGUM SUSPENSION**

Fixed suspension at both sides of the fixture perfectly integrated with the AC and Dali cable input. While it might be necessary to have a flexible suspension cable position to cater for different ceiling types. The Longum is ready for it.





**TUNABLE WHITE  
UPLIGHT  
3000K-6500K**

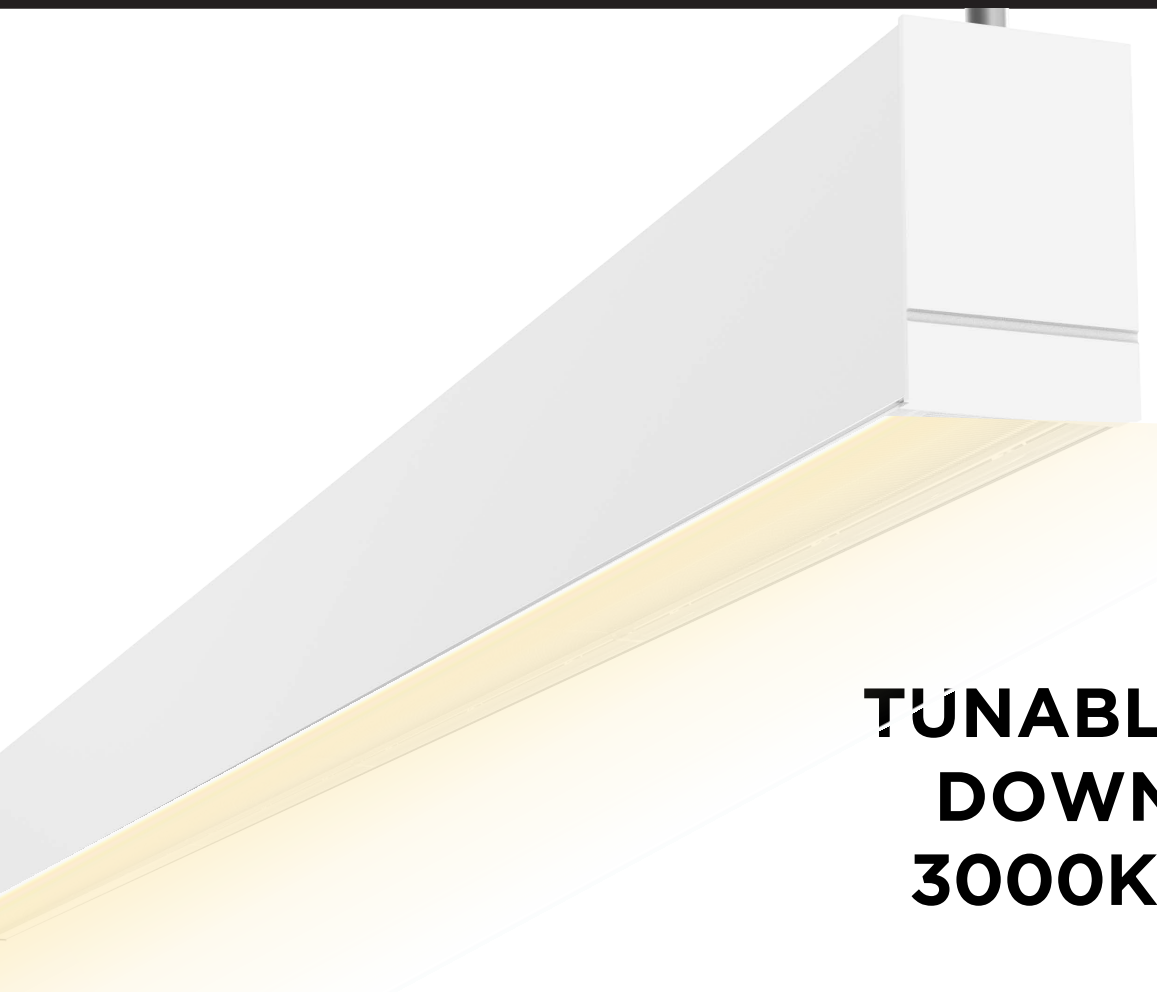
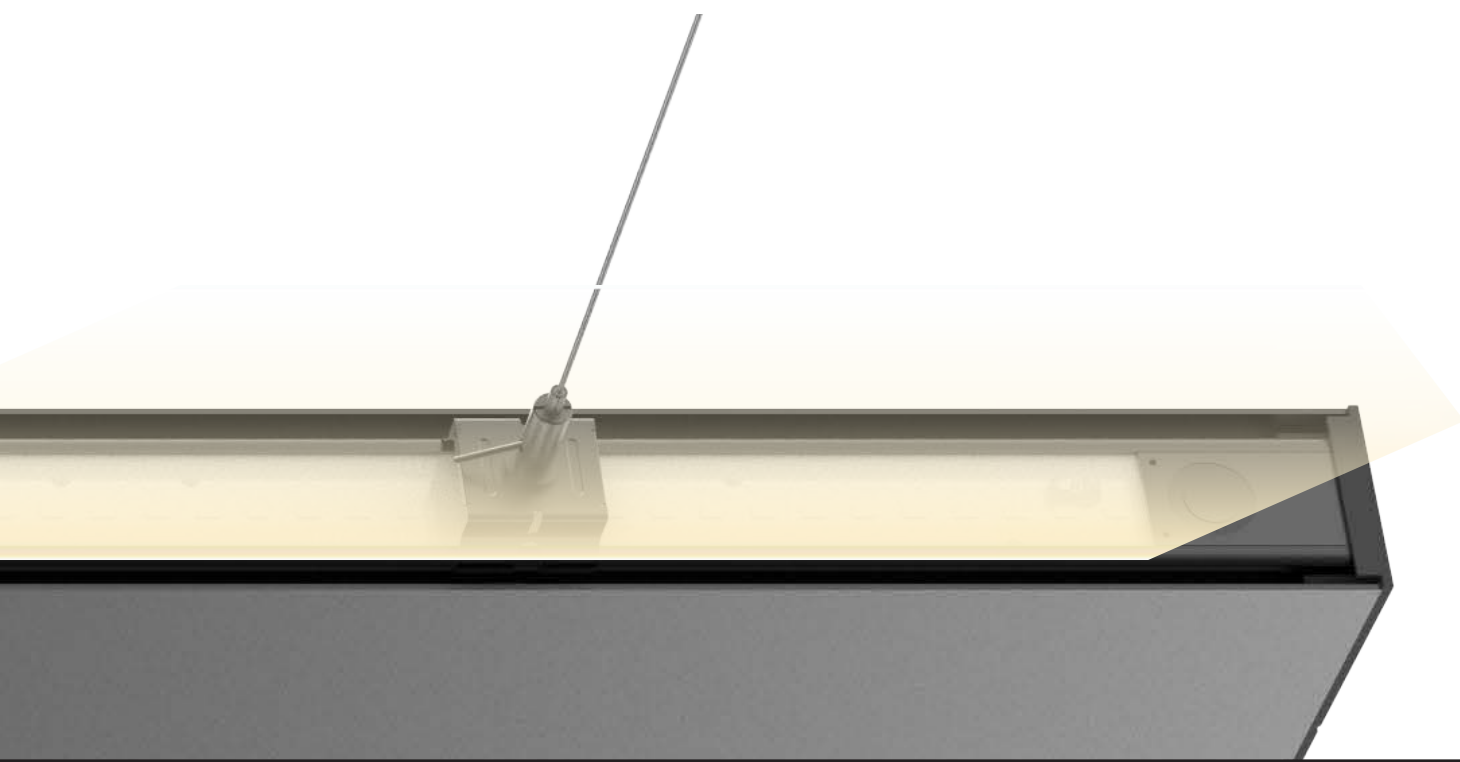

**TUNABLE WHITE  
DOWNLIGHT  
3000K-6500K**



# TUNABLE WHITE 3000K-6500K DAYLIGHT RHYTHM



## **WARM 3000K**

Warmwhite creates a warm ambiance used during (lunch) breaks and at the end of the day.

## **NEUTRAL 4000K**

Neutral white is normally used during "normal" office hours

## **COOL 6500K**

Coolwhite has a lot of blue in it, that is being received by a receptor in the back of our eyes signalling our body to lower our melatonin levels keeping us awake and focussed. Often used after 15:00 hours or when working during evening or night hours.

# LINEAR LIGHTING SERIES LONGUM



## TECHNICAL PARAMETERS

Length	1413 mm	2818 mm	
Down lighting	40 Watt 6000 Lumen	40 Watt 6000 Lumen	
Width* Height	50*75mm		
UGR	<19		
Beam angle	80°		
Light Efficiency	150lm/w		
Lighting	<b>Up lighting:</b> DALI DT8 3000K-6500K <b>Down lighting:</b> DALI DT8 3000K-6500K		
Up-Lighting	18w 1980 Lumen	24w 2640 Lumen	
Weight	t.b.a KG	t.b.a KG	



School



Office



Store



Supermarket

### LED Linear System - Longum

Item	Details	Remark
Color temperature:	3000K - 6500K Tunable white	≤3 SDCM
CRI:	> 80	
LED:	Down lighting: SMD3030, Up lighting: SMD5630 Down lighting: PMMA, Upper lighting: PC	
Light emission:	Direct distribution through a lens	
Service life:	Epistar LED: 50,000hrs	25C
Housing Material	aluminum	
Housing Color:	white / black / silver 220-240V AC, 50/60Hz	White is normal; other color can be customized.
LED Driver:	Halocc or Osram or Tridonic Dali DT8	
PF:	> 0.9 IP50	
Impact resistance:	IK05	
Insulation class:	insulation class I (protective earthing)	
Permissible ambient temperature:	-25C...+45C	ta=45
Package:		
Mounting:	surface mounted / suspension	

# LINEAR LIGHTING SERIES LONGUM

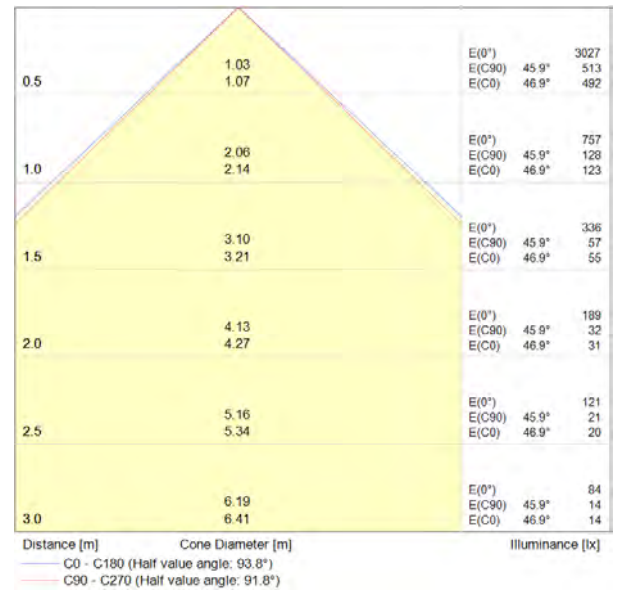
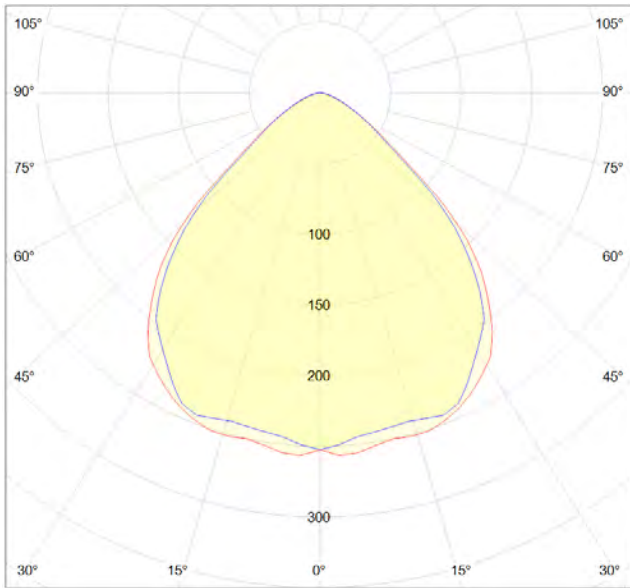

## Glare Evaluation According to UGR

ρ Ceiling	70	70	50	50	30	70	70	50	50	30	
ρ Walls	50	30	50	30	30	50	30	50	30	30	
ρ Floor	20	20	20	20	20	20	20	20	20	20	
Room size X Y	Viewing direction at right angles to lamp axis					Viewing direction parallel to lamp axis					
2H	2H	17.1	18.2	17.4	18.4	18.6	16.9	18.0	17.2	18.2	18.4
	3H	17.3	18.2	17.6	18.5	18.7	17.2	18.1	17.5	18.3	18.6
	4H	17.3	18.2	17.6	18.4	18.7	17.2	18.1	17.5	18.4	18.6
	6H	17.3	18.1	17.6	18.4	18.7	17.3	18.1	17.6	18.3	18.6
	8H	17.3	18.1	17.6	18.4	18.7	17.3	18.0	17.6	18.3	18.6
	12H	17.3	18.0	17.6	18.3	18.6	17.3	18.0	17.6	18.3	18.6
4H	2H	17.2	18.1	17.6	18.4	18.7	17.1	17.9	17.4	18.2	18.5
	3H	17.4	18.1	17.8	18.5	18.8	17.3	18.0	17.7	18.3	18.7
	4H	17.5	18.1	17.9	18.5	18.8	17.4	18.0	17.8	18.4	18.7
	6H	17.5	18.1	17.9	18.4	18.8	17.5	18.0	17.9	18.4	18.8
	8H	17.5	18.0	18.0	18.4	18.8	17.5	18.0	18.0	18.4	18.8
	12H	17.5	18.0	18.0	18.4	18.8	17.6	18.0	18.0	18.4	18.8
8H	4H	17.4	17.9	17.8	18.3	18.7	17.3	17.8	17.8	18.2	18.6
	6H	17.5	17.9	17.9	18.3	18.7	17.4	17.8	17.9	18.3	18.7
	8H	17.5	17.8	18.0	18.3	18.8	17.5	17.9	18.0	18.3	18.8
	12H	17.5	17.8	18.0	18.3	18.8	17.6	17.9	18.0	18.3	18.8
12H	4H	17.4	17.8	17.8	18.2	18.7	17.3	17.8	17.8	18.2	18.6
	6H	17.4	17.8	17.9	18.2	18.7	17.4	17.8	17.9	18.2	18.7
	8H	17.5	17.8	18.0	18.2	18.7	17.5	17.8	18.0	18.2	18.7

Variation of the observer position for the luminaire distance S

S = 1.0H	+0.8 / -1.7	+0.8 / -1.6
S = 1.5H	+2.2 / -3.5	+2.0 / -3.1
S = 2.0H	+3.9 / -4.9	+3.5 / -4.3

Standard table	BK01	BK01
Correction summand	-2.9	-3.0

Corrected glare indices referring to 3000lm total luminous flux

**JIBE LIGHTING — HEADQUARTERS**  
Hogebrinkerweg 14V - 3871 KN Hoevelaken  
Netherlands Tel: +31 (0)33 844 7111  
info@jibe.lighting - www.jibe.lighting



**LED THERE BE LIGHT**

**JIBE LIGHTING — GERMANY**  
Marie-Curie-Ring 38- 63477 Maintal  
Germany Tel: +49 (0)6181 90 90 509  
Mob : +49 (0)162 26 36 614  
fax : +49 (0)6181 61 01 618  
s.fischer@jibe-lighting.de

**JIBE LIGHTING — NORHT AMERICA**  
5917 NW 63 Way - Parkland FL 33067  
USA Tel: 954-899-4040  
todd.darling@jibeusa.lighting

© 2019 Jibe Lighting - all rights reserved

Jibe reserves the right to alter material, dimensions and characteristics without prior notice. Read installation instructions carefully. Technical information on the installation instruction has precedence over the information in the brochure.

Our general terms and conditions shall apply notwithstanding any stipulation to the contrary to all the orders and agreements with Jibe.

You can obtain a copy of these conditions on demand.

For latest information and specifications of the full product range visit [www.jibe.lighting](http://www.jibe.lighting)