

DAVIS ®



2023

*Over 50 Years of
Fun on the Water*

Huntington Lake, California

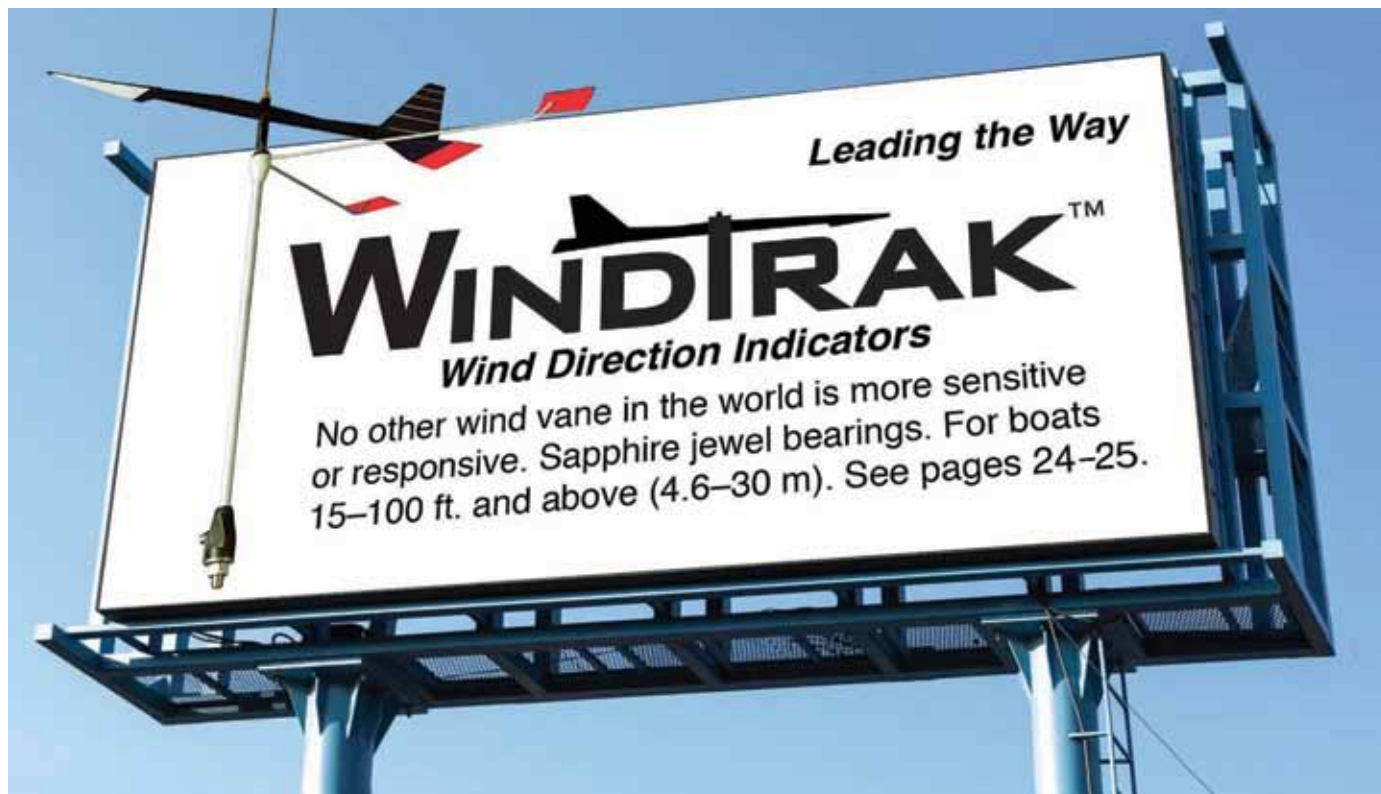

Table of Contents

Sextants 4

- Mark 15 Master Sextant
- Mark 25 Master Sextant
- Mark 3 Sextant
- Artificial Horizon

Telescoping Boat Hooks and Paddles 5

Shockles™ In-Line Shock Absorbers 6-8

- LineSnubber
- DockShockle
- LineGrabber
- MiniShockles
- AnchorSnubber
- FenderFriend

Docking Aids 9

- Rocker Stopper boat stabilizer
- Fender Tender II
- Chafe Guard line protection

Launching Wheels for Small Craft 10

Performance Hydrfoils 11

- Doel-Fin for all boats
- Whale-Tail XL for waterskiers

Steering Lubrication 12

- Cable Buddy for cables
- Lube II for steering rods
- Max-Lube extreme service lubricant

Fishing Accessories 13

- Happy Troller trolling plate
- Lil' Fella trolling plate
- Fish Seeker trolling depth control

Boating Comfort 14-15

- Motor Caddy outboard motor hoisting harness
- Prop Sox propeller protector
- Rudder Position Indicator
- Line Snubber 22 rubber shock absorber
- Swim Stirrup

Quick Reference Cards 16

- Navigation Rules
- Coastwise Piloting
- International Navigation Rules
- Boating Guide
- Weather Forecasting
- Celestial Navigation

Boat Maintenance 17

- FSR Fiberglass Stain Remover

Onboard Tools 18-20

- Quick Fist rubber clamps
- Tiller Tamer tiller stabilizer
- Cable Covers chafe protection
- Snap Tool Multi-Key 19 tools in one
- Sail Track Stops
- Deluxe Rigging Knife (p. 27)

Personal Well-Being 20-21

- Key Buoy self-inflating key bob
- Queaz-Away wristbands for the unpleasant effects of travel
- Air-Dryr dehumidifier

Radar Reflectors 22

- Echomaster
- Emergency Radar Reflector

Wind Direction Indicators 23-26

- WindTrak line of premium wind vanes
- Blacksmith carbon wind vanes
- Wind-Tels
- Air-Flow Tels
- Spar-Fly

Hand Bearing Compass 27

Stainless Steel Snaps 14

Over 50 Years of Innovation

Davis Marine Sextants



1969

Echomaster Radar Reflectors

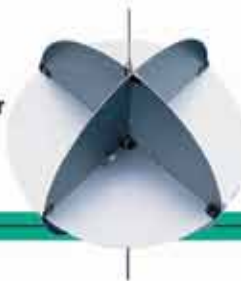

Team Telescoping Boat Hooks and Paddles



Black Max Wind Indicator for Sport Boats



Digital Original Weather Station

FSR Fiberglass Stain Remover



1980

1990

Davis Chafe Guard Line Protection



Doel-Fin Performance Hydrofoil



Fish Seeker Trolling Depth Control Plane



2000

Happy Troller Trolling Speed Control Plate



Air-Dryr Convection Dehumidifier



Vantage Pro Weather Station

Whale Tail XL Stabilizer and Ski Boat Fin



Vantage Vue Weather Station

Shockles In-line Shock Absorbers



2010

WindTrak Wind Direction Indicators

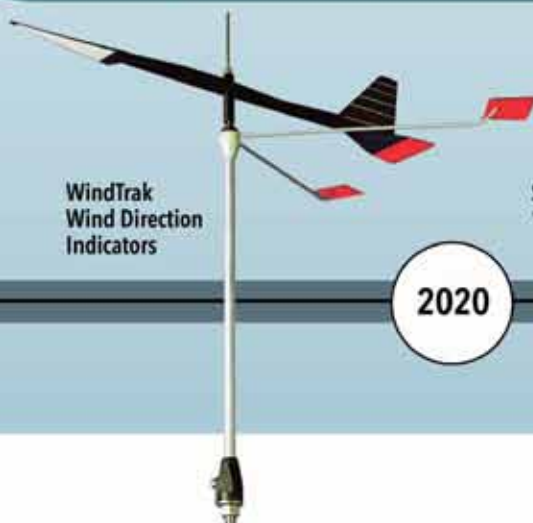

Snap Tool • Multi-Key 19 tools in one



2020

Master Sextants

DELUXE MARK 25 with full-field dielectric Beam Converger™



Traditional
half-silvered
horizon mirror

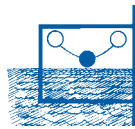

Beam Converger
with full viewing
field



- Full-field dielectric Beam Converger with quartz hardcoat replaces conventional half-silvered mirror. Horizon and astrobody images are combined in a single full-field for easy, reliable sights under the most difficult conditions.

- Special mineral coating is selective for different wavelengths of light. Horizon is transmitted in one color region and the star or sun in another.

- Improved reinforced plastic stiffens frame for greater measurement accuracy.

- High-efficiency LED (solid-state Light Emitting Diode) illumination system, which floods arc and drum with soft light. The LED will last for the lifetime of the sextant.* Batteries, which are included, will last up to 10 times longer than with regular bulbs. This is another Davis first! Positive "push-on" switching action, with vinyl boot water protection.

- Weights 16.5 oz. (0.47 kg) #025

11698 00250 4

\$459⁹⁹

Extra Beam Converger and Index Mirror, Spring & Screw Kit

#R025F \$59⁹⁹ 011698 00272 6

* Average LED half-life is approximately 10 years if operated continuously.

TIP A traditional split image mirror can easily be added to the Mark 25. Order a Mark 15 Extra Mirrors, Spring and Screw Kit, part #R026H.

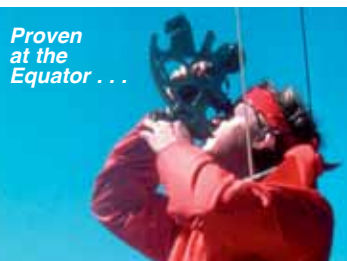

Proven
at the
Equator . . .

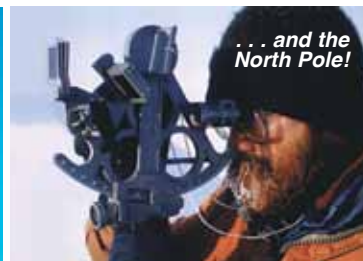

. . . and the
North Pole!

MARK 15

- Large, easily adjusted mirrors using new instrument-quality glass and a special baked on salt-spray resistant backing. Both mirrors have protective housings. Horizon mirror is half-silvered. No adjustment wrenches required.
- High-impact, weather-resistant plastic.
- Weights 14.5 oz. (0.41 kg)

#026

011698 00260 3

\$399⁹⁹



Extra Mirrors, Spring and Screw Kit #R026H \$39⁹⁹ 011698 00271 9

Both Davis Master Sextants feature professional specifications:

- 7" (18 cm) frame radius. Graduation 120° to -5°
- Index mirror rectangular, 1.98" x 1.49" (50 x 38 mm).
- Precision machined slow travel gear and worm mechanism.
- Highly visible, easy-to-read micrometer drum and vernier allowing readings to 2/10 minute of arc.
- Fully ribbed, three-circle sextant body for platform strength and stability.
- Large, contoured handle designed for sure, steady grip and angled back for added control.
- Seven large sunshades allow complete, independent adjustment of shading density for horizon and index mirrors.
- 3 x 27 mm star telescope with anti-reflective coated glass lenses, plus

separate hooded sight tube for glare-free sun shots.

- Neck lanyard frees hand and protects sextant.

- Tough, fully padded, shock-resisting carrying case with compartments for extra batteries and mirror kits.



MARK 3 SEXTANT

Learn to Navigate!

- Rugged, full-size instrument suitable for ocean navigation to any port in the world
- Used by professional, amateur and student navigators alike
- Sextant case with foam cushion can be purchased separately (#R014A)
- Instruction booklet included



#011
Mark 3 Sextant

011698 00110 1

\$99⁹⁹

ARTIFICIAL HORIZON

Practice navigation without going to sea!

More accurate than a natural horizon...

Answers the need of every sextant user who cannot depend on a natural sea horizon. Use for backyard practice, finding exact position when inland, and making exact sextant shot on foggy mornings. To use, fill with water and read the angle of the reflected sun with your sextant. Half your sextant reading is the sun's angle above the true horizon. Windproof and corrosion resistant, the reflecting surface is completely enclosed. Comes with two sun shades, a lid and full directions. Compact 6 x 4 x 1 1/2" (15 x 10 x 4 cm).



#144
Artificial Horizon

011698 01440 8

\$49⁹⁹

Team™ Adjustable Boat Hooks

The Most Dependable Twist Lock and Strongest Boat Hook End!

A tough boat hook is a valuable asset when launching, docking, mooring or retrieving your favorite hat. Team telescoping boat hooks adjust to 8' or 12' (240 and 370 cm). The threaded end accepts a deck brush, mop, squeegee and other accessories. A highly visible, soft vinyl orange tip covers the threads and protects the boat's finish when fending off. All Team boat hooks float. The hook of unbreakable Lexan® is lighter than (brittle) metal alloy ends. Durability GUARANTEED to last a lifetime. Don't settle for less! Tube diameters are between 1-1 1/4" (25-32 mm).

PRACTICAL SAILOR Says It Best:

"Davis proves to be the best pole and the best value as well."
 "Complicated hook designs (like Davis) are preferable to get a line to a dock or piling." "It's rare to find the best product is also the best buy."
 "They (Davis hooks) float while some sink like stones, they're light to handle, the twist-lock joints withstood a lot of pressure, and we couldn't break the heads."

"Tug Tests Take 10 Boat Hooks to the Limits," *Practical Sailor*



#5141 Boat Hook, end only to replace most 1" (25 mm) boat hooks.

011698 00169 9

\$1799

TELESCOPING BOAT HOOKS



#4122 Telescoping Boat Hook 011698 41220 4 **\$59.99**

2 sections. Adjusts from 53 in. to 8 ft. (140 to 240 cm).



#4132 Telescoping Boat Hook 011698 41320 1 **\$64.99**

3 sections. Adjusts from 38 in. to 8 ft. (100 to 240 cm).



#4152 Telescoping Boat Hook 011698 41520 5 **\$79.99**

3 sections. Adjusts from 54 in. to 12 ft. (140 to 370 cm).

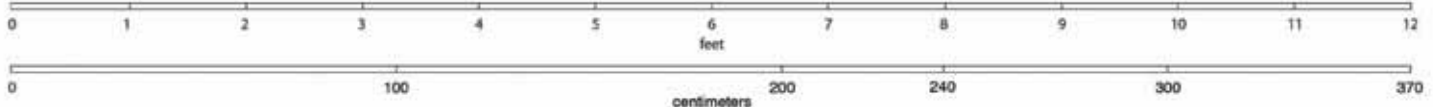

Davis features the strongest twist-lock mechanism. Some twist-locks begin slipping at 85 lbs. (Sea Dog); some go to 175 lbs. (West Marine). The Davis twist-lock holds up to 280 lbs.

Davis boat hooks float—sometimes up to a week!

TELESCOPING PADDLES

Paddles are required by law in many states aboard PWCs and small boats. Team adjustable paddles stow easily and telescope to 3'9" (50 to 115 cm). Our Paddle/Boat Hook combination is great to have on board and at the launch ramp. The bright orange paddle end doubles as a signaling device. Made tough for years of hard use.



#4330 Telescoping Paddle 011698 43300 1 **\$64.99**
 2 sections. Adjusts from 20 in. to 3 ft. 9 in. (50 to 115 cm).



#4372 Telescoping Paddle/Boat Hook Combination 011698 43720 7 **\$74.99**
 2 sections. Adjusts from 32 in. to 5 ft. 6 in. (80 to 170 cm).

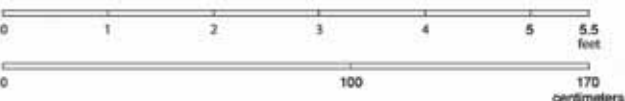



SHOCKLES®

Shock Absorbing Solutions

Shockles are designed to absorb all shock loads at the dock, at anchor, on a mooring and on land. By absorbing shock loads, Shockles quiet anchor chain noise, and extend the life of dock lines and anchor lines by minimizing wear and chafe. When rigged properly, jarring from tidal surge and wind waves is eliminated increasing both comfort and safety aboard.

SHOCKLES LINE SNUBBER™

**Minimizes stress on ALL lines—
for use on any boat!**

LineSnubbers feature our *progressive tension design*—the more they stretch the more tension it takes to stretch them. This minimizes the return force and dampens shock loads better than traditional rubber snubbers. LineSnubbers attach to the line by using a traditional clove hitch knot, or by using an optional Davis LineGrabber. The Davis LineSnubber is easily adjusted for varying conditions, and it can be readily be moved from line to line, unlike rubber snubbers where the line is woven into the snubber.

One size fits all boats and all line from 3/8 to 3/4 inch (10–19 mm). LineSnubber can be attached to 1 inch rope (25 mm) by using a Davis LineGrabber #2460.



LineSnubber is stronger than most double-braided line. For example, SWL on 5/8 inch (16 mm) double-braid is 3500 lbs. (1590 kg). When properly rigged and LineSnubber reaches maximum stretch, the line bears the load, not LineSnubber. Internally, a **PATENTED Line Stretch Limiter** is combined with marine-grade elastomer for durability and strength. Hollow, UV resistant nylon webbing is sewn over the internal mechanism and two 316 stainless steel carabiners allow for quick and easy attachment.

Many LineSnubbers are going strong after ten years!

For marine applications:

- LineSnubber reduces shock to any line, cleat or ground tackle, including bow rollers and rigging
- Attaches, adjusts or removes quickly; use a simple clove hitch or a pair of Davis #2460 LineGrabbers (see page 5)
- Reduces or eliminates noise from creaking, groaning dock lines or ground tackle—jarring is minimized, too
- Compensates for tidal surge and chop from wind and waves
- Rigged properly, LineSnubber keeps boats centered in the slip



Docking



Tender Towing



Boom Tie Down



Spinnaker Tack



Boom Preventer



Anchoring

Shockles are strong, but should always be rigged in-line with the load. Never allow them to bear a load alone. Allowing a maximum of eight inches (20 cm) of slack before the line bears the load will result in many years of service from LineSnubber.



#2400 LineSnubber, blue
011698 01055 4

#2410 LineSnubber, black
011698 01956 1

\$74.99
PATENTED

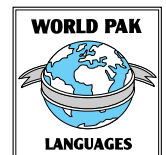

SHOCKLES® DOCKSHOCKLE™

Smaller can be better.

DockShockle was designed to prevent wear and tear on all lines on smaller, lighter boats up to 40 feet (12 m). The same **Progressive Tension Design** and **PATENTED Line Stretch Limiter** are used in this smaller version of our LineSnubber. DockShockle comes with a pair of Mini LineGrabbers and two 316 stainless steel carabiners. Use on line from 3/8 to 3/4" (10–19 mm). The webbing is 12" long (31 cm) in the relaxed position.



Sailboats



Powerboats



Inflatables



Mini LineGrabbers included with DockShockle create a quick and secure attachment loop by using a basic Prusik hitch.

DockShockle should be set up with 3–6" (8–15 cm) of slack in the line to safely absorb and buffer shock loads caused by wind, waves, chop and tidal influences.

TIP Use DockShockle on floating docks as a stabilizer.

TIP Keep helical screw anchors set by using DockShockle to absorb constant, tugging loads.

#2415 DockShockle, black
011698 01057 8

\$59⁹⁹



LINEGRABBER™

Made of 1/4" (6 mm) ultra-high molecular polyethylene fiber with a sewn loop at each end, LineGrabber measures just 9" (23 cm) overall length. Create a strong attachment loop in line from 3/8 to 1" (10–25 mm) by using a basic Prusik hitch. UHMP fiber rope is tough and durable enough to attach to anchor chain, toe rail, shackles, rails & pulpits, roof racks, etc. to create a secure attachment loop that will hold up to 2000 lbs. (900 kg) tensile strength.



LineGrabber safely carries loads to help solve challenges that pop up like a fouled jib sheet, loose anchor, missing dock cleat, or a bow eye that's too small. Sold in pairs.



Create an Attachment



Unload a Sheet



Grab a Railing



Secure a Chain



- Toe Rail
- Cleat
- Grab Rail or Pulpit
- Vehicle Rack

#2460 LineGrabber, PAIR
9" end to end (23 cm)

011698 01079 0

\$19⁹⁹

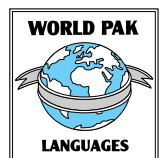

MINISHOCKLE™

What is your load worth?

Featuring a stainless steel wire gate snap rated to 300 lbs. (136 kg) Safe Working Load, this is truly a bungee cord on steroids. Take MiniShockles boating, camping, fishing or hiking—anywhere you want to secure a load. We all carry valuable things on our boats, RVs, automobiles and off-road vehicles. And, we have all been disappointed by standard bungee cords with hook ends that often hold just 36 pounds (16 kg). UV resistant nylon webbing is sewn over marine-grade elastomer for durability and strength. Three sizes. Black.

MiniShockles—strong, tough, secure.



Stainless steel wire gate snap



Sailing



Camping



Fishing



RVs

#2430 MiniShockle 12" (31 cm)
011698 01059 2

\$24⁹⁹

#2440 MiniShockle 18" (46 cm)
011698 01063 9

\$26⁹⁹

#2445 MiniShockle 24" (61 cm)
011698 01067 7

\$29⁹⁹

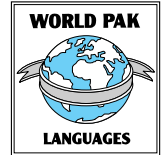

ANCHORSNUBBER™

Keep your anchor set.

AnchorSnubber quiets chain noise and helps keeps your anchor set by minimizing shock loads. Use directly on chain, anchor rode, or snubber line. Made with the same features employed in LineSnubber—**Progressive Tension Design** and **PATENTED Line Stretch Limiter**. Comes with two 316 stainless steel key pin shackles that can run through most bow rollers and compensate well for chain twist. Fits most anchor chain. Webbing is 20" (51 cm) long. Black.



Attach to the chain before the bow roller. The key pin shackle will run through most bow rollers. It's ideally suited to withstand side loads associated with chain twist.

Always set up with slack in the chain. The slack only needs to be 4–6" (10–15cm) to take the load off the capstan and quiet chain noise.

#2420 AnchorSnubber, black **\$69⁹⁹**

011698 01058 5

FENDERFRIEND™

Every fender needs a friend.

FenderFriend is a fender whip, fender hanger and fender adjuster—all in one. Anyone can attach fenders quickly and easily. Attaches almost anywhere.

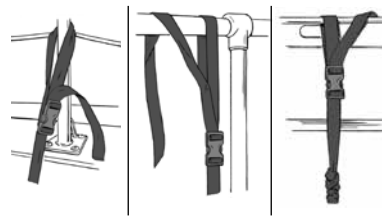

Stretches when fenders get pinched between the hull and the dock. Minimizes loads on stanchions, rails, cleats and lifelines. UV resistant nylon webbing is sewn over marine-grade elastomer with a Nexus® nylon buckle for superior strength. Strap adjusts from 16 to 72" (0.4–1.8 m). Trim strap to useful length with sharp scissors and heat-melt the trimmed strap end.

Two models to choose from; Twin-Eye or Center-Tube. Sold individually. Black.



#2450 FenderFriend, Twin-Eye, black

011698 01071 4



#2455 FenderFriend, Center-Tube, black

011698 01075 2



Built-in shock absorber stretches 12 inches (31 cm)!



Tighten or loosen strap to adjust fender height.

A little bit of stretch helps keep fenders in place.

\$27⁹⁹

ROCKER STOPPER™



A hydrodynamic device scientifically designed to stabilize a boat moored, anchored, or drifting.

The more wind and waves, the better Rocker Stoppers work!

With engines off or sails down, you feel the sea as you stop for meals, fishing, rest or sleep. Rocker Stopper is the solution—efficiently dampening the effects of waves and wake on a stationary boat. Designed for rugged use.

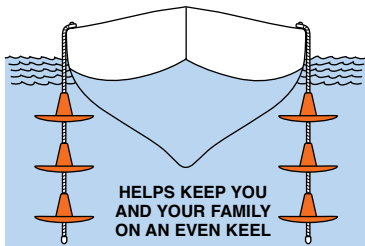

HELPS KEEP YOU AND YOUR FAMILY ON AN EVEN KEEL

For sailboats, powerboats, fishing boats, too!

Lightweight and molded of high-impact, virtually indestructible styrene. Can be deployed or retrieved in seconds. Salt water resistant, gentle to the sides of your boat. Units "nest" within each other, so storage is a breeze.

TIP Rocker Stoppers are excellent for slowing drift while fishing, and can also be used as a dock stabilizer.

Number of Rocker Stopper Units Needed on Each Side of a Boat

Up to 26 feet (0 - 8 m)	3
27 to 36 feet (8 - 11 m)	4
37 to 42 feet (11 - 13 m)	5
43 to 50 feet (13 - 15 m)	8

Length of Boat

#352 Rocker Stopper, individual unit

\$19⁹⁹

011698 03520 5

14" (36 cm) dia. 1 lb. (.45 kg) weight

FENDER TENDER II™

The original! Grips all!



Use this Davis accessory to clip your fenders to rails, lifelines, side wing windows or cleats. Fender Tender II simplifies the handling and relocation of boat fenders. "Railing Lock" firmly grasps rails from 7/8" to 1" (22 to 25 mm) diameter. "Lifeline Lock" provides added safety. Use 1/4" to 3/8" (6 mm to 9 mm) diameter nylon line. Made of tough, sun-resistant plastic for many years of use. Helps tidy up your boat.

RAILS

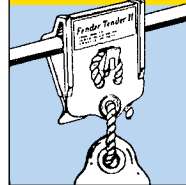

LIFELINES

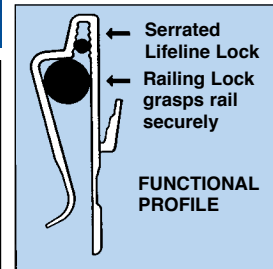
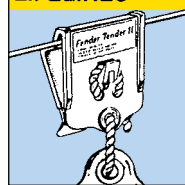

SIDE WINDOWS

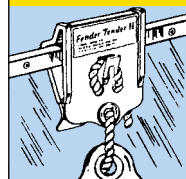

CLEATS

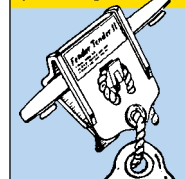

#393 Fender Tender II, PAIR

011698 03930 2

\$12⁹⁹

WORLD PAK



CHAFE GUARD

REMOVABLE



Protect Your Lines with Removable/Adjustable Chafe Guards

Chafe protection is critical at the dock, at anchor or on a mooring. Davis offers a great solution to prevent chafing over a cleat, cap rail, where two lines cross or at the anchor roller. Dock lines can be expensive—extending their life with good chafe protection is not!

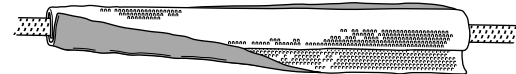

Hook-and-loop fasteners along ENTIRE interior surface grip the line—no need for additional ties

Davis Removable Chafe Guards fit braided or twisted line from 3/8 to 1" (10–25 mm). They're easy to remove and adjust as lines stretch or chafe protection is needed elsewhere. Great for dock, mooring and anchor lines where wearing through a line could cost you the boat. The outside cover is made of tough, UV-stabilized nylon webbing. The inside is lined with hook-and-loop fasteners to grip the rope.

#395 Chafe Guard, White. Pair.

011698 03950 0

#397 Chafe Guard, Black. Pair.

011698 01269 5

WORLD PAK



\$32⁹⁹



Wheel-a-Weigh™

LAUNCHING WHEELS

Get your small craft to and from the water quickly, safely, easily!

Mounts wide on the transom to distribute the load and leave clearance for outboard motors.

The boat can be operated without removing the wheels in most cases.



#1482 STANDARD
For loads up to 220 lbs. (100 kg)

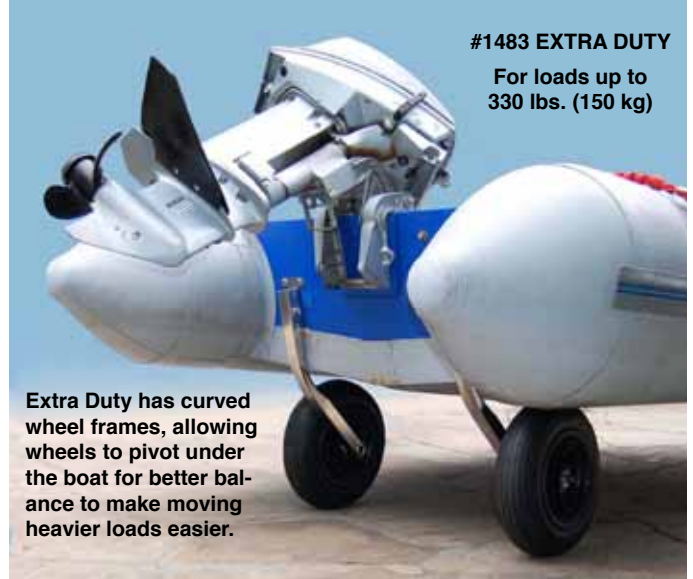

#1483 EXTRA DUTY
For loads up to 330 lbs. (150 kg)

Extra Duty has curved wheel frames, allowing wheels to pivot under the boat for better balance to make moving heavier loads easier.

Wheel-a-Weigh features:

- Portable and removable
- 316 stainless steel frames and pivot brackets
- Inflatable tires
- Precision molded, non-corrosive wheel hubs
- Stainless steel installation hardware included
- Easy-to-follow instructions

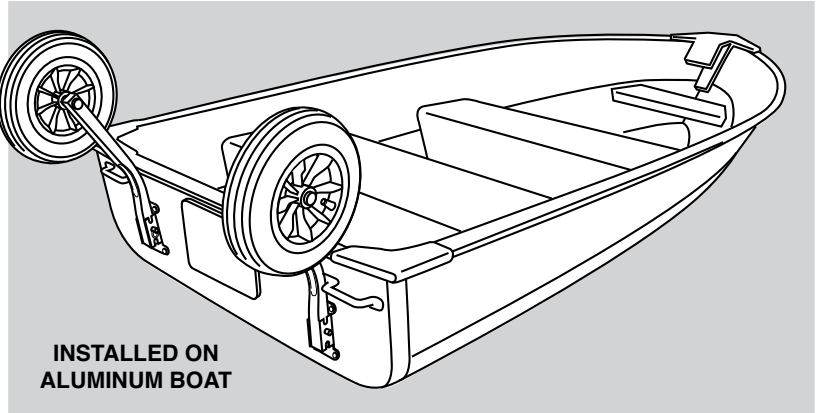
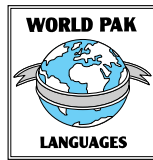

INSTALLED ON ALUMINUM BOAT

A detent pin on each pivot bracket lets you position the wheels up or down, or remove them completely for storage.

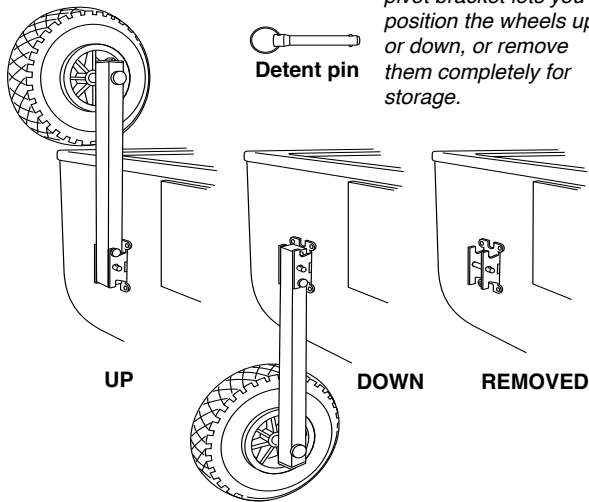

#1482 Wheel-a-Weigh Standard with 10" (26 cm) inflatable tires.

220 lb. capacity (100 kg) handles most boats with motors up to 10 HP.

Weighs 9 lbs. 4 oz. (4.2 kg).



#1483 Wheel-a-Weigh Extra Duty with 14" (36 cm) inflatable tires and roller bearings inside hub. Curved wheel frames pivot under the boat for better balance.

330 lb. capacity (150 kg).

Weighs 15 lbs. 11 oz. (7.2 kg).

Wheel-a-Weigh products are not designed to be towed behind a vehicle.

011698 01273 2

\$199⁹⁹

011698 01274 9

\$299⁹⁹



Enjoy the ride! 100% Satisfaction Guaranteed

Over three decades of testimonials and 1,000,000 customers agree that Doel-Fin delivers!

Doel-Fin is the original hydrofoil developed by an aeronautical engineer to **improve overall performance on boats with outboard motors or outdrive units**. Molded in two pieces of guaranteed unbreakable, high-strength plastic, each foil is designed to flex independently to absorb shock. The positive effects include greater stability, consistent planing at lower RPM, faster out-of-the-hole performance, steadier turns, higher top-end speeds and lower bow rise at all speeds.

- Doel-Fin improves overall performance— even on boats with well-designed hulls
- Save up to 30% on fuel consumption
- Faster out-of-the-hole for happier water-skiers
- Maintain lower planing speeds without constant throttle adjustments for wakeboarding, tubing or beginning skiers
- Less bow rise for better visibility and increased safety
- Simple 15-minute installation; hardware included

Doel-Fin is designed for use with small motors, big motors, and inflatable dinghies. Boats with small motors no longer “porpoise” with the bow-up when the throttle is applied and achieve planing at lower engine speeds. Big motors benefit from less stern suction, faster planing times and steadier turns. All these features add up to increased fuel efficiency.

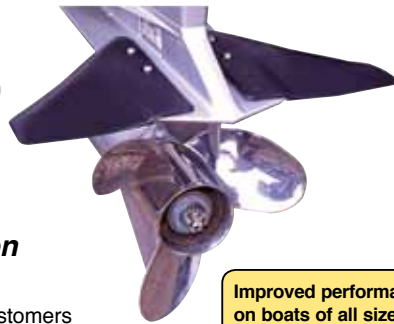

Improved performance on boats of all sizes, from small dinghies to large ocean cruisers!



Balanced Performance

Doel-Fin was designed to produce maximum lift while minimizing drag. Creating lift in the stern compensates for motor weight for smoother turns, better gas mileage and less stern drag.



#440 DOEL-FIN Stabilizer, set of left and right fins, black

011698 00185 9

Fits all motors except Volvo Penta® 280 and 290 outdrives.

\$39⁹⁹

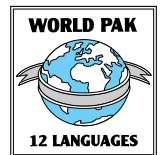

Aluminum Stabilizer and Ski Boat Fin



\$99⁹⁹

#448 WHALE TAIL XL Stabilizer & Ski Boat Fin
011698 00639 7

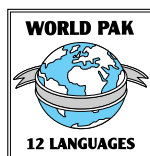

The **Whale Tail XL** unique hydrodynamic design extends behind the prop to utilize prop wash energy which is normally lost. Whale Tail transforms this energy into lift for immediate response when the throttle is applied. Use Whale Tail XL in fresh or saltwater.

Improves performance in any I/O or outboard motor

- Pops skiers up in less time
- Flattens wake for waterskiing; creates positive, skid-free turns
- Stabilizes bow-light boats
- With bow lowered, visibility and safety are improved
- Smooths out ride in rough water
- Reduces porpoising & cavitation
- Increases top speed and fuel savings in most applications
- Mounts on the anti-cavitation plate of all inboard/outboards and outboards
- Installs in 15 minutes with stainless steel hardware included
- Marine grade aluminum with durable anodized finish

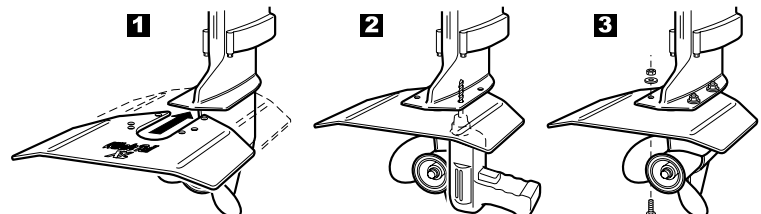

It's simple! Position Whale Tail XL on the horizontal plate right above the propeller, clamp in position and drill, secure with bolts. See complete instructions included.



IT'S EASY TO PREVENT STEERING PROBLEMS!

KEEP WATER & DIRT OUT...

... PUT LUBRICANT IN!

THE ONLY PRODUCT THAT LUBRICATES STEERING CABLE

CABLE BUDDY™

#420

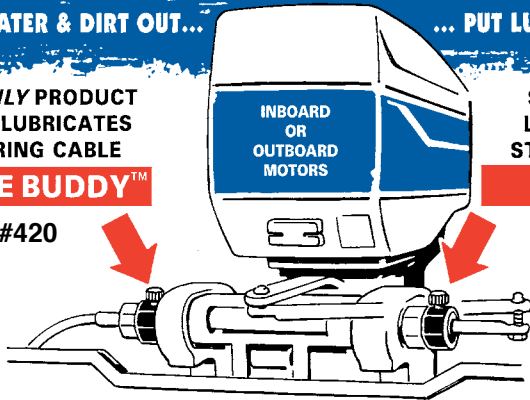

SEALS AND LUBRICATES STEERING ROD

LUBE II™

#425

7/8" x 14 pitch threads fit U.S. and Japanese outboard motors



Max-Lube™ oiling-tube method (Lube II shown)



STEERING CABLE LUBRICATION SYSTEM



STEERING ROD SEALER & LUBRICATOR



EXTREME SERVICE LUBRICANT

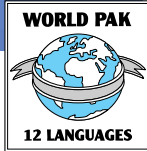

Cable Buddy is a complete steering cable lubrication system. Includes the stainless steel Cable Buddy nut with plug and sealing washer, oiling tube assembly, and Max-Lube, the ideal lubricant for steering cables. Works on inboards, outboards, and inboard/outboard steering cables. Fits all major U.S. and foreign motors (7/8" x 14 pitch threads). Seals moisture out, puts lubricant in. Prevents corrosion and freezing down to -40°F (-40°C). Cable Buddy lubricates and virtually eliminates all wear in the inner cable, where most problems occur. Easy to install (if you can take the cable off, you can install the Cable Buddy). Install the Cable Buddy now...or deal with the hassle and expense of replacing your steering cable later!

#420 Cable Buddy with 1 lube nut & Max-Lube **\$47⁹⁹**

011698 04200 5

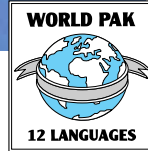

Lube II allows sticky, hard to move steering rods to be properly and easily lubricated for smooth, easy steering action. The system includes a stainless steel lubricating nut with an oil seal and a grease (zerk) fitting. This lubricator's unique design keeps moisture and contaminants out while enabling you to pour or pump several types of lubricant in. Your choice: (1) Max Lube (#422) synthetic lubricant with high water separation qualities and anti-corrosion protection. This is the best lubricant available for the purpose. (2) A high grade 90w synthetic gear oil. (3) High quality white lithium grease. Lube II helps correct and prevent steering problems. For both mechanical and hydraulic systems. Fits all major U.S. and foreign motors (7/8" x 14 pitch threads). Easy, 10 minute installation. Marine grade stainless steel for salt and fresh water use.

#425 Lube II **\$29⁹⁹**

011698 04250 0

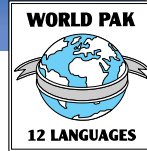

Max-Lube excels under pressure— anywhere oil is required. This proprietary synthetic film has many advantages over other synthetic and premium oils: superior rust and corrosion protection, rapid separation from water, greater stability at temperature extremes, 10-20% reduction in operating temperature, and 5 times greater load carrying. The net result is smoother, quieter, cooler and longer operation. Max-Lube is recommended for steering cables (all boat motors, fresh or salt water), sporting equipment (fishing reels, guns, bike chains), all gears regardless of type or size, and all metals.

#422 Max-Lube 3 fl. oz. • 90 ml **\$19⁹⁹**

011698 04220 3



Slows even big motors down to that "ever-so-slow" fish tantalizing speed

Happy Troller is the answer to correct trolling speed

A significant advancement in the sport of troll fishing, **Happy Troller** mounts on the anti-cavitation plate to allow fine control of trolling speed. Your boat's stability is enhanced at cruising speed for a smoother ride in rough water, reduced porpoising and cavitation.

Use it year-round in all boating activities—great for use in both salt and fresh water

Made of highest quality stainless steel and marine aluminum, with clear anodized aluminum finish. Installs in 15 minutes with hardware included. Comes with full installation and operating instructions.

Two Models:

Large fits inboard/outboards plus all outboard motors 50 HP and larger.

Small fits outboards from 25 to 50 HP.

#460 Large Happy Troller \$189⁹⁹

011698 00635 9

#461 Small Happy Troller \$169⁹⁹

011698 00636 6



Two sizes fit all I/Os and outboard motors

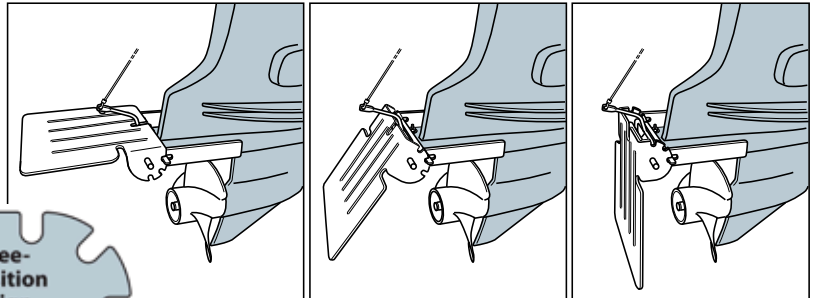

Three-position design for added flexibility

Locks in "up" position for cruising, "down" for trolling, with middle position for ultimate trolling control!

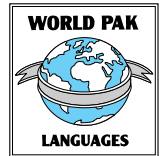

For motors under 25 HP, see Lil' Fella™ product #462.

lil' fella™
Trolling Plate

Little brother to the Happy Troller®



A fisherman's answer to correct trolling speed

- Fits all outboard motors up to and including 25 HP
- Locks "down" for trolling, "up" for cruising
- Made of highest quality polycarbonates with stainless steel hardware, included
- Comes with full installation and operating instructions

For motors above 25 HP see Happy Troller® products #460 and #461.



#462 Lil' Fella Trolling Plate \$99⁹⁹

011698 00637 3



Precisely Sets Your Trolling Depth!

Great for SALMON, TROUT, STEELHEAD, WALLEYE, CRAPPIE and STRIPER.

Turns over and surfaces when fish strikes



Trolling at 2 MPH with Fish Seeker, you can choose any trolling depth from 5 to 80 feet (1.5 to 25 m). Simply choose the right setting for desired depth, let out enough line and troll at slow speed. For salt or fresh water fishing and 6–25 pound test line. A good replacement for outriggers or heavy lead ball sinkers. Not for use with deep diving lures.

\$999

#510 FISH SEEKER, chartreuse
011698 00188 0

#511 FISH SEEKER, hot pink
011698 00189 7

#512 FISH SEEKER, clear
011698 00190 3

How Fish Seeker's depth is controlled: Using a chart supplied with the product, attach your rod line snap swivel to a lettered hole and your leader snap swivel to a numbered hole. Release the amount of line specified, and Fish Seeker will dive to the desired depth.



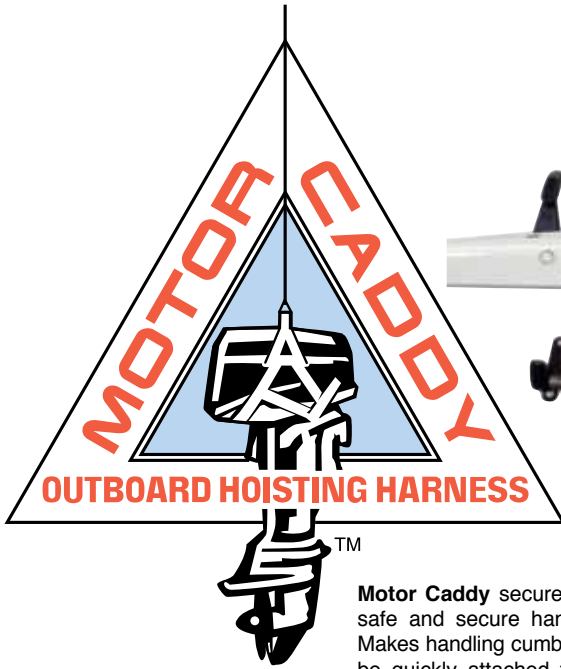

**#430 Motor Caddy
Outboard Hoisting Harness**
011698 04300 2

\$34⁹⁹



**Fits 4-stroke motors
up to 15 HP**

**The Safe and Easy
Way to Move an
Outboard Motor**

Motor Caddy securely attaches to outboards to provide a safe and secure handle for carrying, hoisting and lifting. Makes handling cumbersome motors safer, simpler. Sized to be quickly attached to most outboards from 2-15 horsepower. This unique design features a longer strap to fit 4-stroke motors and an added security strap for today's streamlined engine cases. Made of UV resistant materials that will endure the marine environment for those who prefer a semi-permanent installation. Glass filled Nexus® nylon buckles insure easy installation and removal. May be installed with buckle on either side of the motor. The webbing is one continuous piece; pulling on one side will tension the other side. The self-centering handle serves as the lifting point for lanyards and hoists, or balanced lifting by hand.

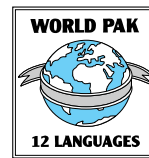

**STAINLESS STEEL
HARDWARE**

**Same high quality snaps used
in our Shockles® products**

Polished 316 stainless steel stands up to the toughest marine and outdoor environments. Very competitive prices.



- 2470 Carabiner.** Captive, 3/8" stock (10 mm) by 3 7/8" long (10 cm). Safe working load 1200 lbs. (500 kg). **\$24⁹⁹**
011698 01080 6
- 2480 Key Pin Halyard Shackle.** Captive, 5/16" stock (8 mm) by 3 1/16" long (8 cm). SWL 1500 lbs. (700 kg). **\$24⁹⁹**
011698 01081 3
- 2490 Wire Gate Snap.** 1/4" stock (6 mm) by 2 3/8" long (6 cm). SWL 415 lbs. (188 kg). **\$14⁹⁹**
011698 01082 0
- 2500 Wire Gate Snap.** 5/16" stock (8 mm) by 3 1/8" long (8 cm). SWL 968 lbs. (438 kg). **\$24⁹⁹**
011698 01083 7



**Protection for
Propellers and
People**



Prop Sox are socks for your prop. They protect your expensive propellers from road kickback when towing. Reflective hot dots alert drivers following too closely behind. People walking by a boat on a trailer can be cut without Prop Sox in place. The bright, molded plastic socks simply slip over each propeller blade and are held in place with a rubber shock cord strap. For use on boats out of water only.

#450 Prop Sox Set of 3 \$15⁹⁹

011698 00186 6

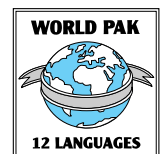

RUDDER POSITION INDICATOR



**Avoid Veering—
and Collisions!**

Awareness of the rudder angle is a most important safety factor. This is especially true while moving in and out of your berth, drawing alongside another boat, picking up a skier, mooring, or any other "close call" situation. Davis' Rudder Position Indicator gives instant visual reference of rudder angle. The pointer swings a full 30° with each revolution of the wheel. Mounts easily with its self-adhesive pad directly to your hub. Indicator is approximately 2" (5 cm) in diameter. Rugged, hermetically sealed, weatherproof and sunproof housing ensures long life. No cables, adjustments, or electricity required; gravity power makes it simple and service-free. Suitable for boats with mechanical and single station hydraulic steering systems.

#385
Rudder Position Indicator

011698 03850 3

\$34⁹⁹

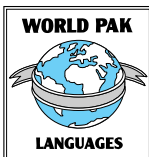

Line Snubber™



*A Shock Absorber
for Your Lines*

For fishing lines, too!

Line Snubber helps reduce stress and wear on your lines and cleats. They're available in 22" length (56 cm). Molded of highest quality rubber for years of service. Packaged in pairs.

Sailors, fishermen and other boaters will find many uses for Line Snubber, from anchor snubbing to trailering. Using them on parallel lines maximizes their effectiveness. Sailors can use them to lash a tiller, tie down a halyard or rig a boom preventer. Snub docking lines and mooring ropes. Reduce shock on fishing lines, too. Line Snubbers will secure a dinghy in place or keep one steady while being towed. Protect your lines, cleats, boat components and surfaces from wear with Line Snubber.

#1468 Line Snubber 22, PAIR **\$21⁹⁹**

011698 00651 9

SWIM STIRRUP™



The Safe Solution to a Slippery Situation

The **Swim Stirrup** provides safe, easy access to small boats for swimmers or water skiers. Durable, reliable design attaches to gunwales, transoms, or open bows.

- Perfect for rowboats, ski boats, dinghies, sailboats
- Adjustable length to fit your boat
- Complete hardware and instructions included
- Easy to install, easy to use—it even floats!

#1466
Swim Stirrup

011698 00649 6

\$34⁹⁹

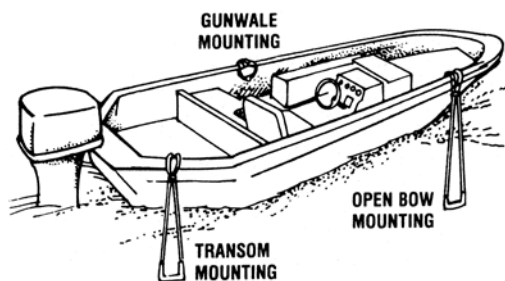

Quick Reference Cards

Accurate Information at a Glance—Quicker than an Internet Search!

Make your outing safer, easier... more fun!

For quick decisions, get quick answers with Quick Reference Cards. They're efficiently formatted and full of great information. Take them along on your next outdoor adventure or classroom activity.

Cards sold separately **\$14.99** each

All cards feature:

- Full color both sides
- Punched for binder or bulkhead mounting
- Weatherproof high strength plastic
- Full 8 1/2 x 11" (22 x 28 cm) size



U.S. Coast Guard
Auxiliary



U.S. Power
Squadrons

Quick Reference Cards were designed in close cooperation with the U.S. Coast Guard Auxiliary and U.S. Power Squadrons. They are standard equipment on many U.S. Coast Guard and state boating administration patrol boats.

NAVIGATION RULES

A Must for Safe Boating in an Easy to Use Format

#125 011698 01250 3

A proven navigation tool used by the U.S. Coast Guard, U.S. Power Squadrons, and U.S. Coast Guard Auxiliary. Navigation Rules feature U.S. Buoyage System, inland and international rules, right-of-way, lights, sound signals, and bridge signals. All presented in graphic summary and easy to read. Complete, precise, accurate.



COASTWISE PILOTING

It's easy to forget the procedures and find yourself lost or in danger!

#126 011698 01260 2

All the piloting information you need at your fingertips: dead reckoning basics, true and magnetic compass relationships, position finding, estimating distance off, current and leeway corrections.

Helpful hints on chart reading, preparations and checklists, fog navigation, and depth soundings without a fathometer. Includes time, speed & distance calculator, relative bearing gauge for distance off calculations, common chart symbols.



INTERNATIONAL NAV RULES

The Latest Information Covering Oceans & Waterways of the World

#127 011698 01270 12

A comprehensive guide incorporating the International Maritime Buoyage System and COLREGS. Clarifies differences between Cardinal and Lateral buoyage systems and buoyage regions, key to reducing confusion and danger when entering unfamiliar waters or busy harbors. Complete details on right-of-way, sound signals, entering and clearing a foreign port, lights and day shapes, collision prevention procedures, signal flags.



BOATING GUIDE

Small Craft Seamanship, Vital Boaters' Safety Information

#128 011698 01280 0

Covers all the basic procedures and equipment. Includes predeparture checklist, recommended equipment & spare parts, fueling procedures, engine troubleshooting, radio use, trailering, launching, anchoring, water skiing hand signals.

Gives rules of the U.S. Buoyage System and right-of-way. Helps in emergencies by covering distress signals, fire procedures, towing, weather warnings, first aid (hypothermia & CPR).



WEATHER FORECASTING

Making Marine Forecasts Using Nature's Own Signs

#131 011698 01310 4

Shows the use of wind direction, barometric pressure and cloud type to predict the weather. Includes full listing of radio weather stations for official broadcasts. Has key information on navigation in fog, hazardous wave and surf conditions, storm warnings, hurricane avoidance, and more! "Time tested method...easy to understand. This is a complete guide for becoming 'weather wise.'"

—Ken Lilly Jr., CDR. NOAA (ret.), marine meteorologist



CELESTIAL NAVIGATION

Determine Location Using the Sun & Stars

#132 011698 01320 3

A simplified, yet complete, Celestial Navigation system. Makes it easy, proving that lengthy instruction is not necessary to master celestial navigation. Includes everything

you need: sextant use and corrections, starfinder for 18 stars, data entry form and step-by-step sight reduction and plotting procedures. May be scored and separated; large portion fits in sextant case for quick reference and, small part acts as a waterproof data reduction card.



FSR™ FIBERGLASS STAIN REMOVER

THE BEST THERE IS!

FSR is a unique stain absorbing gel that serves a variety of purposes both ashore and afloat. It's ideal for removing oil, rust, exhaust, waterline and transom stains, yet it can also be used anywhere else fiberglass stains may crop up—shower stalls, furniture, etc. Use for removing road soil from trailered boats and recreational vehicles. Its non-abrasive quality means that it's safe to use on white painted surfaces as well as on gel-coat. Requires no sanding or compounding. Simply apply with a brush, sponge or cloth. Wait a few minutes and then wipe off or rinse. **USE ON SHOWERS AND SPAS, TOO.**

- Great for exhaust and waterline stains
- Removes rust from stainless steel stanchions and railings
- Excellent for removing "rust bleeders" from hull or deck
- Removes road dirt from RVs and trailer boats
- Removes rust stains from clothing, sail cloth, and other fabrics
- Safe on white painted surfaces

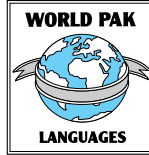

TIP Take FSR home to the kitchen to bleach and sanitize wooden cutting boards



Apply, wait a few minutes, rinse or wipe off. Waterline stains gone!

#790 FSR
16 fl. oz. • 1 pint
0.47 liter

011698 07900 1

\$14⁹⁹

#792 FSR Big Job
67.8 fl. oz.
2.0 liters

011698 07920 9

\$36⁹⁹

Test a small area first to be sure FSR will not damage finish



Use on stainless steel and enjoy the shine!



Rust stains on fiberglass gone!



Use on showers and spas—the stain absorbing gel is non-abrasive.



Quick Fist™

One Piece Rubber Clamp

Securing your equipment just got a whole lot easier!

Two Sizes Grip Anything
from 7/8 to 7 1/2" (22–191 mm)

Quick Fist is a rubber clamp that mounts easily to keep tools and equipment firmly in place. Ideal for boats, off-road trucks, military equipment, ATVs, or any vehicle. Quick Fist clamps are made of heavy duty transportation grade rubber. They're UV resistant and withstand extreme heat or cold. Mount easily with #10 (5 mm) bolts or screws. Terrific for marine use—Quick Fist will not rust or corrode. Available in standard or super sizes.

#540



#544



Quick Fist

Standard **Quick Fist** is ideal for stowing or transporting tools. Can also be used as a pipe stand-off (do not use on exhaust pipes). Mounts easily with one #10 (5 mm) bolt or screw (not included). Can be mounted with strap facing any direction. To clamp, pull strap through jaw and lock into place. Sold in pairs. Multiple Quick Fists can hold larger tools.

- Holds objects from 7/8–2 1/4" in diameter (22–57 mm)
- Each clamp supports approximately 22 lbs. (10 kg)



#540 Quick Fist Clamp Package includes 2 clamps
Mounting base measures 7/8 x 2 3/4" (22 x 70 mm)

\$19⁹⁹

011698 00821 6

SUPER Quick Fist

Super Quick Fist is ideal for holding fire extinguishers, oxygen cylinders, CO₂ tanks, and other equipment. Mounts easily with three #10 (5 mm) bolts or screws (not included). Can be mounted with strap facing any direction. To clamp, pull strap through jaw and lock into place. Strap can be trimmed off for neat installation.

- Holds objects from 2 1/2–7 1/2" in diameter (64–191 mm)
- Each clamp supports approximately 50 lbs. (23 kg)



#544 Super Quick Fist Clamp
1 clamp
Mounting base measures 7/8 x 6" (22 x 152 mm)

011698 00822 3

\$19⁹⁹

tiller-tamer™ Like having an extra crew member!

TILLER STABILIZER & LOCK



Tiller-Tamer maintains cruising course with no hands, in any weather or wind conditions. The tension is smoothly adjustable from fully locked to fully free. Tiller-Tamer gives improved control and feel to the tiller handle. Does not interfere with automatic steering systems. No loss of cockpit space. No need to lash the tiller when boat is moored or trailered. Equally adaptable to inboard rudder tillers, too!

#2205 Tiller-Tamer \$44⁹⁹

011698 22050 2

CABLE COVERS

Protect sails and sheets from chafe

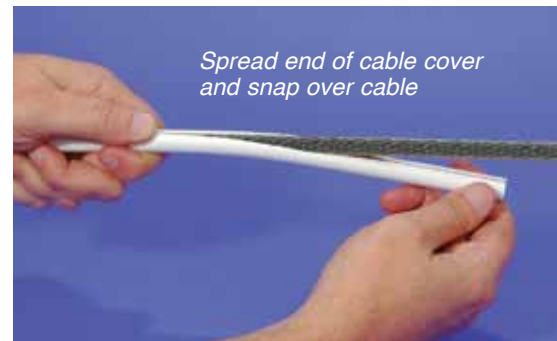

- Keep sails clean, prevent wear
- Slit along covers for quick "snap-on"
- Tough, durable plastic with more ultraviolet absorber than other brands—last longer!

CABLE COVERS

Product No.	Fits Cable Size	Cable Cover Length	Price Each
252 011698 02520 6	1/8" (3 mm)	6 ft. (180 cm)	\$ 3.99
253 011698 02530 5	5/32" (4 mm)	6 ft. (180 cm)	3.99
254 011698 02540 4	3/16" (5 mm)	6 ft. (180 cm)	3.99
255 011698 02550 3	1/4" (6 mm)	6 ft. (180 cm)	3.99
256 011698 02560 2	5/16" (8 mm)	6 ft. (180 cm)	4.99
257 011698 02570 1	3/8" (10 mm)	6 ft. (180 cm)	5.99

SNAP TOOL • MULTI-KEY™

HANDY • UNIVERSAL • STAINLESS STEEL • STRONG

A pocket-sized tool perfect for all outdoor activities, including boating. This deck plate key with an attitude is a serious tool for serious use outdoors:

Fishing Climbing Biking Sailing Hiking Boating Camping Tailgating RV

19 tools in one! The button snap and zipper pull features make working with canvas a "snap" instead of a chore. And this is a deck plate key that fits most deck plate caps. It's also a pocket-sized hex wrench and screwdriver with both slot and Phillips heads. The cutting blade is designed to cut fishing line and small cord—and the shackle key works on stainless or galvanized pin shackles. Made of corrosion resistant stainless steel, it's both thicker and stronger than other inexpensive deck keys—all at an affordable price. At five o'clock this new Snap Tool Multi-Key is ready to become your affordable best friend!

PATENTED



Canvas shrinks, button snaps corrode—no problem!



Weathered zippers are hard to pull—not anymore!

Constructed of specially hardened stainless steel. **Will not corrode or break...ever!**

TIP Attach a Key Buoy self-inflating key ring #530 to Snap Tool • Multi-Key to avoid losing your favorite tool in the water!

MANY FEATURES

#382 Snap Tool • Multi-Key \$1799
2.75 x 4.48" (7.0 x 11.4 cm)
Unit weight 2.8 oz. (80 g) 011698 01271 8

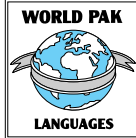

- 7 hex wrenches
- 3 deck plate keys
- 2 screwdrivers
- 2 button snap tools
- 1 scraper
- 1 cutting edge
- 1 zipper pull
- 1 shackle tool
- 1 bottle opener

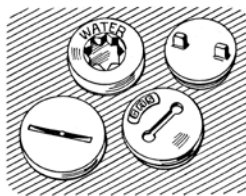

Fits all these deck caps

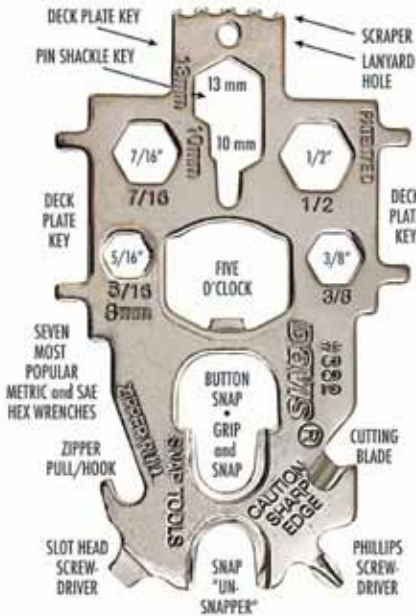

Hook used to pull ring



Screwdriver

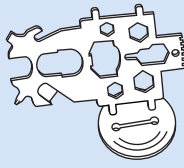
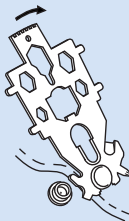
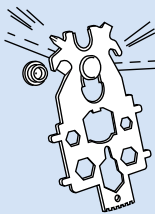
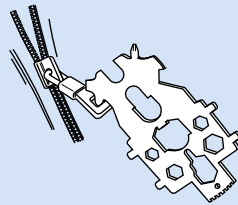
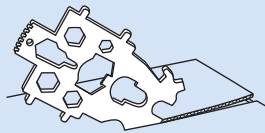
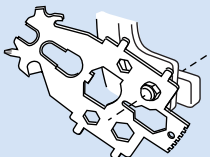
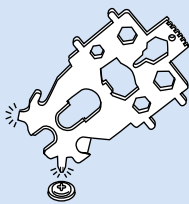
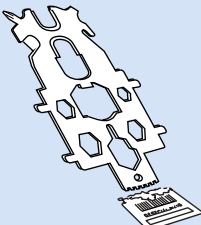
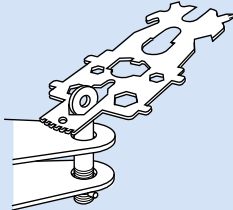
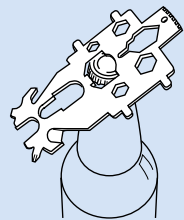

Shackle key

 <p>Deck Plate Key Fits most caps: water, fuel, waste</p>	 <p>Un-Snap Canvas Snaps</p>	 <p>Snap Canvas Snaps Handling button snaps made easy, especially on shrunken canvas or corroded snaps</p>	 <p>Zipper Puller Tames stiff, sticky or oxidized zippers</p>	 <p>Cutting Tool Fishing line, paracord, webbing, cardboard boxes, emergency use</p>
 <p>Hex Wrench Popular sizes: 5/16, 3/8, 7/16, and 1/2 inch—plus 8 mm, 10 mm and 13 mm</p>	 <p>Screwdrivers Both Phillips and slot</p>	 <p>Scraper Removes labels, tape, dry paint</p>	 <p>Pin Shackle Key Tightens or loosens pins on most galvanized anchor shackles and stainless steel pin shackles</p>	 <p>Bottle Opener Enough said!</p>



SELF-INFLATING KEY BUOY®

Never Lose Keys in the Water Again!

- When keys fall in the water, Key Buoy inflates to 14" (36 cm)
- Tube carries keys to the surface for easy retrieval
- Stays afloat for over an hour
- Suitable for items weighing up to 2.8 oz. (80 g) such as key sets and small tools
- A great gift!

\$9⁹⁹

#530
KEY BUOY
self-inflating
key ring

011698 00877 3

PATENTED

Winner of the National Marine Manufacturers Association Innovation Award

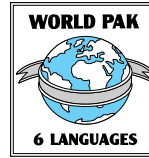

QUEAZ-AWAY™

A non-drug aid that relieves the unpleasant effects of bumpy flights, choppy seas, winding roads, rocking trains, and spinning Ferris wheels.

Queaz-Away wristbands exert gentle pressure on points on each wrist to minimize or eliminate the miserable effects of nausea. Made of tough, long-lasting, washable materials. Safe and easy to use. Simply slip onto wrists, position, and enjoy your trip or outing. One size fits all! Handy carrying case included. Used throughout the world by yachtsmen, pilots, divers, physicians and hospitals.



\$12⁹⁹

#400 Queaz-Away,
PAIR

011698 04000 1

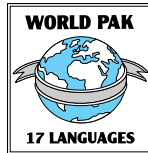

SAIL TRACK STOPS



When it's time to lower your sail, you can rely on Davis' SAIL TRACK STOPS to hold your sail and its slides in place on the mast and boom. Large knurled wheels are released with ease. Made of heavy-duty, black anodized aluminum and marine grade nickel plated brass. Flat stops come with lanyard holes.

\$12⁹⁹

#2350 ROUND .50" dia. x .875" (13 x 22 mm)
011698 23500 1

#2351 FLAT .42 x 1 x .125" (11 x 25 x 3 mm)
011698 23510 0

#2352 FLAT .75 x 1 x .125" (19 x 25 x 3 mm)
011698 23520 9

Air-Dryr™

Say Goodbye to Mold, Mildew and Moisture

Air-Dryr is a silent, inexpensive and effective way to combat moisture, cold drafts and corrosion. Designed to operate anywhere continuously 24 hours a day—just plug it into any 110/120 volt outlet and leave it on. It works best when placed low on the floor of any damp, enclosed space allowing Air-Dryr to draw in cool, moist air. The damp air is gently heated to the point where moisture is held in suspension (above the dew point), then released through the top vents of the device. As warm air rises, more damp air is drawn into the unit, where it too is heated. The resulting natural convection circulates the air and prevents moisture from settling. In a perfect situation, ventilation will remove the moisture laden air, replacing it with drier air.

Air-Dryr fights humidity with a different and simpler approach than dehumidifiers or chemicals that sometimes empty liquids into a sink (or onto the floor when spilled!). Silent, energy efficient operation costs no more to use than a single incandescent light bulb. Designed with a thermal cut-off switch to turn Air-Dryr off if air flow is impeded.

No switches or thermostats to set. Just plug it in and enjoy the results.



Air-Dryr 1000

Air-Dryr 500



Use at Home or Office Basements, closets, under desks, storage units, tack rooms, pump rooms, gun cabinets, pianos



Use in RVs and Airplanes Motor homes, trailers, cars, aircraft



Use in Boats Cabins, bilges, engine rooms, V-berths

Features of both Air-Dryr models:

- Attractive, neutral beige housing made of polycarbonate for strength and durability
- Slim and stable; can be placed out of the way in confined spaces
- Handle a high volume of air
- Low operating cost; designed to be left on 24 hours a day
- Silent in operation, safe to the touch
- Trouble free—no switch, fan, or thermostat
- Safe for marine use—no components which cause sparking
- Air-Dryr is equipped with a THERMAL CUTOFF to prevent overheating due to blocked vent holes, but continued caution is advised.



CAUTION: To prevent fire or damage to the unit, do not block vent holes. Keep out of water to avoid electrical shock. Do not touch hot surfaces. Unplug and allow the unit to cool before cleaning or storing. Do not place on or near a hot gas or electric burner, or in an oven.

Two models



#1459 Air-Dryr 500 Handles up to 500 cubic feet of living space (14.2 cubic meters). Draws only 0.6 amps, 70 watts. Rectangular unit measures 13.5 x 5.5 x 4.25" high (34 x 14 x 11 cm high).

011698 00643 4

\$69⁹⁹

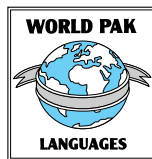

#1458 Air-Dryr 1000 Handles up to 1000 cubic feet of living space (28.3 cubic meters). Draws only 1.1 amps, 130 watts. Circular unit measures 13.5" in diameter, 4.25" high (34 cm dia., 11 cm high).

011698 00642 7

\$89⁹⁹

DAVIS

ECHOMASTER™

Ranked One of the World's Best Radar Reflectors!

Giving ships a chance to see you in fog and low visibility conditions is a must for serious boaters.

Echomaster's full 12.5" (32 cm) diameter circular reflector plates provide 13.2 square yards (12 sq. meters) of maximum effective radar cross section in the X or 3 cm band (9–9.6 GHz frequency), based on optimum orientation between the reflector and radar. Offers equivalent radar cross section of a conventional triangular plate reflector with approximate 17" (43 cm) diagonal dimension.

Robust, marine-grade aluminum plates are sufficient thickness to minimize flexing; dimpled to minimize angular distortion. Tough injection-molded, captive corner latches assure minimum angle error. The 1 1/4" (32 mm) windage holes reduce aerodynamic drag and allow assembly of the reflector around a backstay. Easily assembled or demounted. Stows flat.

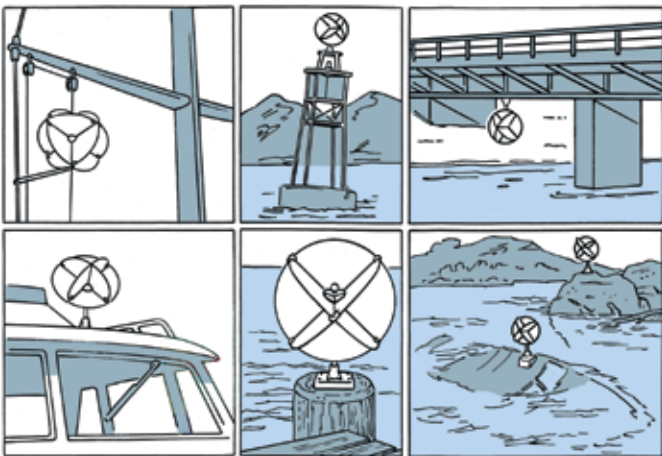

Make your boat visible to other vessels.

Find your way home in less than perfect conditions. Mount a radar reflector on a buoy or piling to help identify your dock or mooring.

Mark hazards to navigation to supplement official channel markings. Install radar reflectors on specific hazards—bridges, rocks, submerged trees, sunken boats.

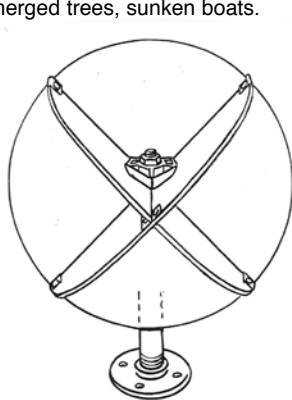

To **SURFACE MOUNT** an Echomaster, use the corner blocks from the #156 Hanging Mount System with five pipe fittings commonly found in hardware stores.

To order the Radar Reflector Booklet separately, contact customer service and ask for #R155E (\$3.00).

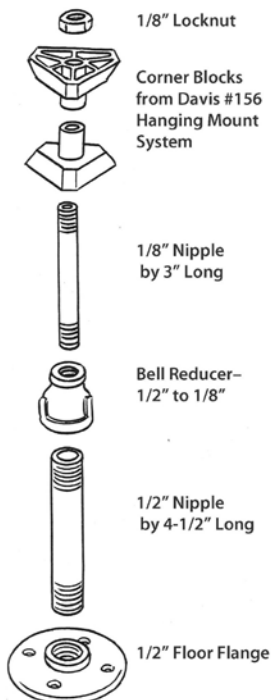

Echomaster meets U.S. Coast Guard requirements for lifeboat and liferaft radar reflectors under SOLAS 74/83.

ECHOMASTER with Marine-Grade Aluminum Plates

12 square meters of radar cross section. Plates are made of sturdy, stamped 1.3 mm thick aluminum with riveted nylon corner latches for quick assembly or disassembly. Install around a backstay using corner blocks from #156 Mount System, or make your own hanging bridle as described in the 16-page Radar Reflector Booklet included with Echomaster.

#152

011698 01520 7

\$119⁹⁹

HANGING MOUNT SYSTEM (no reflector)

Use the hanging mount system to suspend your Echomaster unit from a mast or rigging in the perfect "catch rain" position.

#156 011698 01560 3

\$19⁹⁹



Echomaster's proven superiority:

- Ranked one of the best radar reflectors and one of the top ten sailing products by *Practical Sailor*.
- Rated "superior" by SRI after the most rigorous tests ever conducted on radar reflectors, some costing 10 times as much.
- Performance diagrams from the Admiralty weapons test, England, showed Echomaster's high response to incoming radar at all angles:



DAVIS ECHOMASTER #152

DAVIS EMERGENCY RADAR REFLECTOR #151

MOBRI RADAR REFLECTOR

FIRDELL BLIPPER

RADAR FLAG

Strong peaks, narrow valleys, and 360° returns are desirable.

EMERGENCY RADAR REFLECTOR

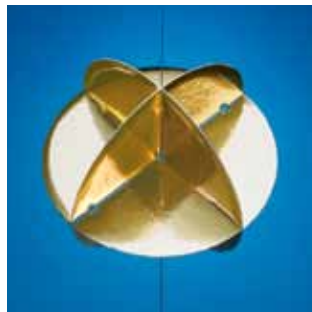

Excellent as a back-up aboard larger vessels or primary reflector on smaller boats that might not normally carry a radar reflector. Made of plastic-metal foil laminate. Opens in seconds and is very lightweight. 11.5" (29 cm) in diameter. Performs almost as well as Echomaster (see performance diagrams above). Economical enough for any boat. Stows flat.

Recommended "Best Buy" by Practical Sailor!

#151
Emergency Radar Reflector

\$39⁹⁹

011698 01510 8



Tough • Versatile • Sensitive

Black Max is a versatile, high performance wind direction indicator that attaches quickly to masts and booms on most small boats such as Lasers and Sunfish. The tough, high impact plastic vane is designed to withstand years of punishment and the abuse of small boat sailing. The stainless steel mounting arm and set screw, as well as a tough plastic mounting base, add to the system's durability. Wind vane length 8" (20 cm).

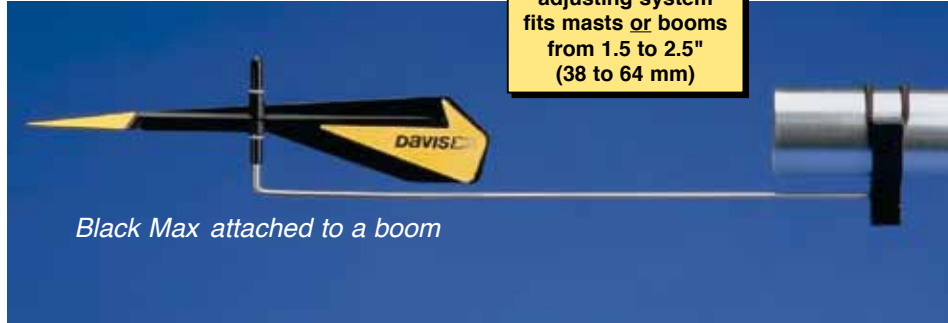

Black Max attached to a boom

Unique adjusting system fits masts or booms from 1.5 to 2.5" (38 to 64 mm)

#1295 Black Max
011698 12950 8

\$59⁹⁹

Extra Vane #1452 \$1999
011698 14520 1

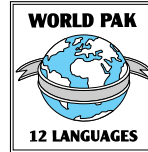

Black Max comes in its own *unbreakable* protective storage tube.

TELO-CAT™



Telo-Cat includes complete mounting instructions for the following catamarans: • Hobie 14, 16 • Supercat 15, 17 • Prindle models with turnbuckle forestay adjuster • NACRA 5.2 Telo-Cat will also fit other catamarans using forestay fittings similar to models above.



A must for your Catamaran!

Designed especially for catamarans, the Davis **Telo-Cat** is durable and highly visible. Installs on the headstay bridle in seconds; easily removed for trailering (no tools required). Comes complete with high visibility 8" (20 cm) vane, adjustable tacking arms, and mounting hardware to fit most catamarans. Made of high impact plastic with a stainless steel shaft and tacking arms. The vane rides on a super sensitive nylon bearing system for extreme accuracy in light or heavy weather. Highly visible markings. Adjustable reference arms. Telo-Cat can take the abuse of catamaran sailing.

Wind vane length 8" (20 cm).
Weight 2.9 oz (82 g).

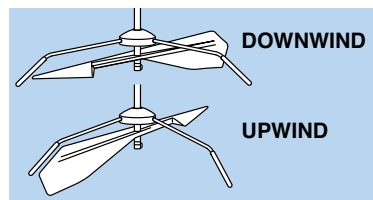

DOWNWIND

UPWIND

#1450 Telo-Cat \$69⁹⁹
011698 14500 3

#1452 Extra Vane \$1999
011698 14520 1



RIGGING KNIFE

High Quality, Sensibly Priced

The Davis Deluxe Rigging Knife is made entirely of top quality stainless steel, with dura-edged blade. This tool features a marlin spike, slot head screwdriver, shackle key and a stainless steel loop to attach a lanyard. This is a sturdy, quality knife that a yachtsman will be proud to own—at an affordable, go-to price.

GREAT FOR:

- Sailors, powerboaters, fishermen
- A keep-aboard spare
- Emergency ditch bag
- Untying stubborn knots
- Loosening stainless and galvanized anchor shackles
- A unique gift

#1551 Deluxe Rigging Knife
• Marlin Spike • Screwdriver
• Shackle Key

\$29⁹⁹

011698 15510 1

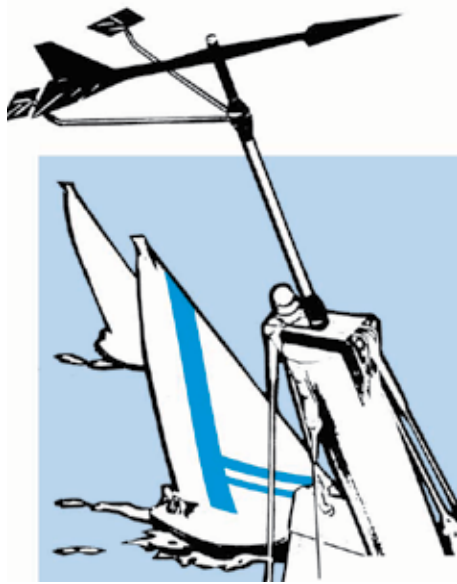

WINDTRAK™ *Leading the Way*

WindTrak wind vanes are well-suited for boats from 15–100 feet and above (4.6 to 30 meters). Every WindTrak features a sapphire jewel suspension bearing, vane with a large fin and low inertia, and an easy-to-read, fully adjustable tacking tab system. Reflector tape on the vane and tabs makes WindTrak highly visible in low levels of light—easy to see at night.

WindTrak vanes are sturdy and durable, wind-tunnel tested to wind speeds of 80 knots! Installed properly, they offer many years of hassle-free use. WindTrak is the standard of quality in the sailing industry.

All sailors appreciate the accurate sensitivity, time-tested durability, and best value that WindTrak provides. Next time you're on the water, look up and see what most sailors choose!

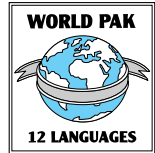

- Sapphire jewel suspension bearing
- Large fin, low inertia vane molded of highly UV resistant plastic
- Adjustable tacking tabs
- Clearly visible reflectors on the tacking tabs and vane
- Optional LED WindTrak Light (#3200) for viewing at night

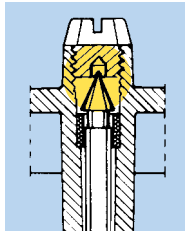

The *sapphire suspension bearing* allows WindTrak to seek wind direction even in winds less than one knot



10" wind vane #3120



With Bird-Proof Spike

15" wind vane #3150

No other wind vane in the world is more sensitive to super light air and small puffs—or more responsive when breeze picks up.

WINDTRAK™ 10

For Small Boats and Dinghies

Sapphire suspension bearing, 10" vane (25 cm) and adjustable tacking arms with tabs. Vane and tabs feature reflectors for high visibility day and night. Includes glass reinforced polycarbonate J-Base for side, top or front of mast mounting on most dinghies, smaller boats and sport boats. Stands just 9.25" (23.5 cm) tall and weighs 1.2 ounces (31 g).

WindTrak 10's J-Base allows mounting on side, top, or front of mast.



#3120 WindTrak 10 **\$44⁹⁹**
011698 00193 4

#3101 Spare Vane only **\$24⁹⁹**
011698 31010 4

WINDTRAK™ 15

The Choice for Most Sailors

Sapphire suspension bearing, 15" vane (38 cm) and adjustable tacking arms with tabs. Vane and tabs feature reflectors for high visibility day and night. Through-bolt or drill & tap mounting socket; 5/16"-18 stainless stud, washers and nut included. WindTrak 15 weighs just 3.9 ounces (111 g). Stands 12.75" (32 cm) tall. Bird-proof spike extends above vane to keep birds off your mast. Optional WindTrak Light #3200.

TIP Sailors concerned with weight aloft can shorten the bird-proof spike.

The J-Base can be purchased separately for WindTrak 15 (#3155).



#3150 WindTrak 15 **\$69⁹⁹**
011698 31500 0

#3151 Spare Vane only **\$39⁹⁹**
011698 31510 9

WINDTRAK™ AV

For Mounting to Most Whip Antennas



15" vane
with antenna
mounting hardware
#3160

WindTrak AV™ installs onto most whip antennas, including Metz™ and Shakespeare™ brands, with a whip diameter less than 1/8" (3 mm). Combine two installations into one to reduce masthead clutter, weight and windage aloft. Rides on low-friction Teflon™ bearings. Complete with 15" (38 cm) vane, reflective tacking arms, hardware and instructions for easy installation. Antenna not included.

#3160 WindTrak AV
011698 31600 7

\$49⁹⁹

#3161 Spare Vane only **\$29⁹⁹**
011698 31610 6

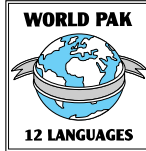

WINDTRAK™ LED LIGHT

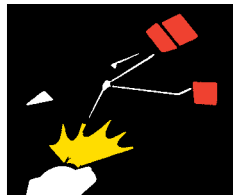

For Viewing
WindTrak Indicators
at Night

Light up the reflector tabs and vane on your WindTrak for easy viewing at night with LED WindTrak Light. Waterproof and non-corroding silver parts give long-life light at less than 100 ma current draw. Fits under WindTrak 15, WindTrak 10 or J-Base™ mounting socket.

#3200 WindTrak LED Light

011698 32000 4

\$39⁹⁹

Some tips for using your WindTrak:

- Always assemble your WindTrak with Loctite® or use silicone seal on the threads to eliminate the possibility of the unit unscrewing in use from vibration.
- Prior to unstepping your mast, take your WindTrak down first. Periodically check the assembly screws holding your WindTrak together.

UNIVERSAL MASTHEAD MOUNT

Extend your WindTrak 10 or WindTrak 15 vane away from masthead obstructions and turbulence. The 13" (33 cm) arm comes with hardware allowing side or top mounting and offset angles up to ±20 degrees. May be attached securely to flat, curved, vertical, horizontal, or inclined surfaces. Gain space aloft and improve mounting position of wind finders and other equipment. Mount on the back of the mast for easier viewing from the cockpit. The mount adapts to virtually every masthead situation.

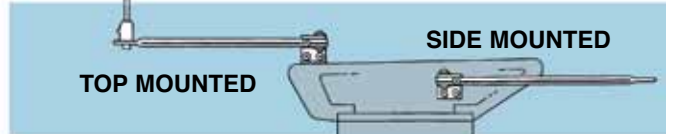

Length 13" (33 cm), weight 3.2 oz (90 g). Boom can be shortened if necessary; complete instructions included. Can be used with WindTrak Light #3200. Also accommodates Davis J-Base Mounts (using #10 stainless steel screws and nuts, not included).

#1705 Universal Masthead Mount

011698 17050 0

\$49⁹⁹

J-BASE™ Versatile Mount for WindTrak 15 and WindTrak 10

Standard with WindTrak 10, the J-Base can be ordered as an option for WindTrak 15. Allows for side, top or front mounting on most masts, on big boats or dinghies alike. J-Base is made of glass filled polycarbonate, 2" (5 cm) long. Includes stainless steel set screw and two #10 self-tapping screws. Reduces overall weight by 15 grams when substituted for standard WindTrak 15 mounting base.



#3155 J-Base for WindTrak 15

011698 00195 8

\$11⁹⁹

#3125 J-Base for WindTrak 10

011698 00194 1

\$11⁹⁹



- Spare parts can be ordered from your local dealer or from Davis; identify which model you have before calling.
- Lubrication is never needed, but years of salt or dirt build-up should be rinsed off with fresh water occasionally.
- Use our Universal Masthead Mount, #1705, for installations requiring more room at the masthead. This mount extends WindTrak away from the masthead up to 12 inches (30 cm).
- Add a WindTrak LED Light, #3200, for nighttime sailing.



BLACKSMITH™ CARBON WIND VANES

Own the Wind!

ALL DAVIS WIND VANES are precisely balanced. Vanes are effective and efficient from 0.8 to 40 knot wind conditions. Each unit is calibrated and tested. Each vane is made and balanced by hand.

CRAZY KIDS

For Optimist and other small dinghies. Dimensions 7 x 11" (18 x 22 cm). Weight 0.5 oz. (14 g). Handmade of black fiberglass and duraluminum. Carbon-free to satisfy Opti-class rules.

011698 01316 6 #3180 **\$32⁹⁹**

OLYMPIC

For boats 13–20 ft. (4–6 m). Dimensions 9 x 9" (23 x 23 cm). Weight 0.5 oz. (14 g). Handmade of 3D carbon and duraluminum. J-base included for side, top or front of mast mounting.

011698 01318 0 #3184 **\$64⁹⁹**

SPORTBOAT

For boats 16–28 ft. (5–8.5 m). Dimensions 9 x 10" (23 x 25 cm). Weight 0.7 oz. (20 g). Handmade of 3D carbon and duraluminum. J-base included for side, top or front of mast mounting.

011698 01319 7 #3186 **\$64⁹⁹**

J-BASE is standard with Olympic and Sport Boat

HORIZONTAL

For Laser, Melges 14, Optimist, Finn and Sabot. Dimensions 12 x 7.8" (30 x 20 cm). Weight 0.8 oz. (23 g). Handmade of 3D carbon and duraluminum. Adjustable mast clamp.

011698 01321 0 #3188 **\$64⁹⁹**

3D Carbon sheet, strong and lightweight, and super responsive to wind shift.
Duraluminum hard-coat anodizing for long lasting cosmetic wear.



OPTIMIST MAST PIN SET #3182 **\$21⁹⁹**

011698 01317 3

WIND-TELS™ Fit All Shroud Sizes



Utilizing port and starboard colored plastic vanes, **Wind-Tels** are ideal for saltwater sailing. The unique method of attachment prevents sliding or fouling of your Wind-Tels on the shrouds. Effective at any angle of heel in the lightest winds. Marine grade metal parts for durability.

#1260 Wind-Tels, 2 Pack 011698 12600 2 **\$79⁹⁹**

#1261 Extra Wind-Tel Vane Set 011698 12610 1 **\$14⁹⁹**

AIR-FLOW TELS™

You're Sailing Blind Without Them!

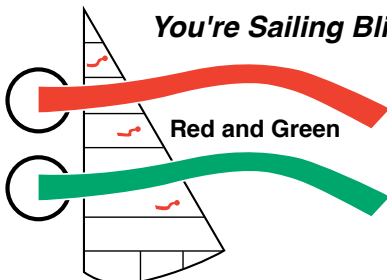

Red and Green

Port and Starboard Colors

#950 14 TELS **\$11⁹⁹**

011698 09500 1

Lightweight, ripstop nylon **Air-Flow Tels** attach to sails with waterproof adhesive locator discs. No holes required. Tels show the air flow across the sails, allowing you to trim sails for maximum performance. Each kit includes 14 Tels and full instructions on where to apply them and how to read them.

The Original SPAR-FLY™



America's Most Popular Wind Indicator!



Comes equipped with BOTH a top mount fitting and a quick-release side mount.

The **Spar-Fly** combines needle bearing balance, high impact plastic, and marine grade metals for unsurpassed sensitivity and durability. Spoiler holes in the vane reduce lift and increase accuracy. Spar-Fly is unaffected by angle of heel. Easily seen from the deck because of its V-shaped silhouette and bright red color. Weighs only 1.25 oz. (35 grams).

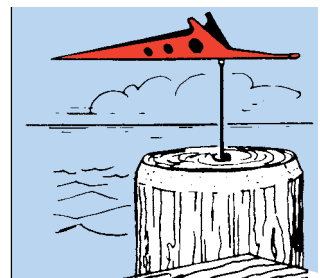

#1310 Spar-Fly **\$44⁹⁹**

011698 13100 6

#1311 Extra Spar-Fly Vane **\$11⁹⁹**

011698 13110 5

TIP Knowing wind direction makes docking easier. Install a Spar-Fly near your berth.



Grade school students using Davis Hand Bearing Compasses out in the Monterey Bay Sanctuary.



Instrument is lightweight, made of high impact plastic. Large, contoured handle designed for sure, steady grip and angled forward for added control. Positive "push-on" switching action, with vinyl boot water protection. Lanyard included. Battery housing has high watertight integrity. Batteries included. Complete instructions.

HAND BEARING COMPASS



Simple, Accurate, Proven

- Sailboat racing • Cruising • Sailing schools
- Navigation classes • Camping, hiking
- Fishing

Using this precision marine hand bearing compass, you can easily obtain quick magnetic bearings on shore or floating objects. Simply align front and rear sights on an object and read off bearing.

Uses include quick bearing or position set, determination of angular gain or loss on the competition while racing, checking distance offshore, establishing lee-bow set while cruising or racing in currents, drift vectoring and plotting a line of position.

The stable, liquid-damped compass card is graduated in 5° segments, with bold graduations every 15° for easy reading. Solid-state LED illumination system floods the compass and sight vane with soft light. The LED will last for the lifetime of the compass.

Average LED "half-life" is approximately 10 years if operated continuously.

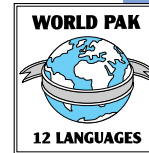

Named "Best Buy" by PRACTICAL SAILOR: "Simple and absolutely fool-proof, especially when you need an accurate bearing in a hurry." "What a bargain!"



#215 Illuminated Hand Bearing Compass, grey

011698 02150 5

\$59⁹⁹

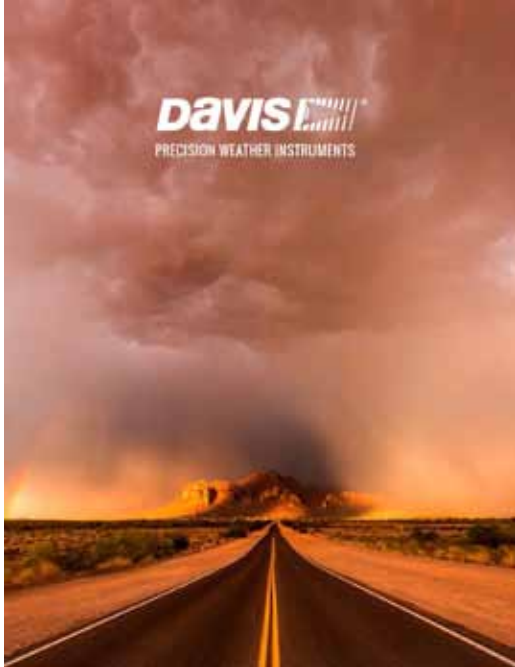

DAVIS PRECISION WEATHER INSTRUMENTS

For over 35 years, Davis Instruments has been an innovator in measuring weather conditions and analyzing the data. Follow this link to our latest weather catalog.

<https://support.davisinstruments.com/article/wti2au0h3g-catalog-weather-instruments>



Davis is a proud member of . . .



National Marine
Representatives Association

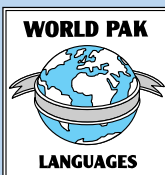

Look for the World Pak symbol indicating language translations printed on packaging and instructions. Some of these Davis products provide up to 17 languages in addition to English.

Customer Service Representatives

Our representatives can answer most questions, assist with your purchase, or provide product literature. Lines are staffed weekdays 7:00 a.m. to 5:30 p.m., Pacific Time.

1 (510) 732-9229 1 (800) 678-3669

Fax Line Available day or night to place orders or submit questions.

1 (510) 670-0589

Technical Support Representatives

For technical questions or trouble-shooting help. Lines are staffed weekdays 7:00 a.m. to 5:30 p.m., Pacific Time.

1 (510) 732-7814

Technical Support Fax Line

Available day or night to submit technical questions.

1 (510) 670-0589

E-Mail Directory

Customer Service Department:
sales@davisinstruments.com

Technical Support Department:
support@davisinstruments.com

For comments or general questions about Davis:
davismarine@aem.eco

World Wide Web

To locate our site: <http://www.davisinstruments.com>

Mailing Address

Send correspondence to:
 Davis Instruments
 3465 Diablo Ave., Hayward, CA 94545-2278 U.S.A.

One-Year Warranty

We warrant our products to be free of defects in material and workmanship for one year from the date of original purchase. Certain products are guaranteed unbreakable for the life of the product. Visit www.davisinstruments.com for details.