

Rover 570

Spare Parts

Ersatzteil-Liste

Pos.	Art. Nr.	Description	Beschreibung
1	18.355.43	Lid black LH	Deckel schwarz LH
2	18.332.37	Lid handle titan-silver	Deckelgriff titan-silber
3	18.850.13	Heat indicator °C/°F	Thermomètre °C/°F
4	18.850.18	Frame for heat indicator	Rahmen zu Temperaturanzeiger
5	18.850.12	Heat indicator-Nut	Temperaturanzeiger-Befestigungsmutter
6	18.331.20	Upper Vent Disc with handle	Ventilationsschieber oben mit Griff
7	18.322.21	Lid Hinge titan-silver complete	Deckelscharnier titan-silber Komplett
8	18.360.31	Upper lid hinge cover	Deckelscharnier-Abdeckung oben
9	18.360.32	Lower lid hinge cover	Deckelscharnier-Abdeckung unten
10	18.332.47	Cooking grid	Grillrost
11	18.330.03	Funnel	Trichter
12	18.330.04	Grease collector pan	Fettauffangschale
13	18.330.06	Charcoal grate	Kohlenrost
14	18.330.07	Booster grate	Anzünderrost
15	18.355.39	Bowl black	Kugel schwarz
16	18.330.47	Tool holder	Besteck-Halter
17	18.332.56	Lower vent disc with handle	Ventilationsschieber unten mit Griff
18	18.332.55	Ash Catcher	Aschenschale
19	18.332.62	Legs upper part titan-silver	Beine Oberteil titan-silber
20	18.332.65	Leg lower part rear left titan-silver	Bein Unterteil hinten links titan-silber
21	18.332.66	Leg lower part rear right titan-silver	Bein Unterteil hinten rechts titan-silber
22	18.332.67	Leg lower part front titan-silver	Bein Unterteil vorne titan-silber
23	18.332.64	Bottom shelf titan-silver	Bodenplatte titan-silber
24	18.332.16	Axle titan-silver	Radachse titan-silber
25	18.365.08	Wheel	Rad
26	18.365.02	Caster with brake	Lenkrolle mit Bremse
	18.379.10	Hardware set	Schrauben set

Attention

Please write your serial number on the backside of the manual for future reference. You will find the number on the data plate attached to the trolley or the bottom plate depending on the grill model. OUTDOORCHEF can only supply spare parts and honour warranty returns when the serial number is available.

Achtung

Bitte notieren Sie auf der Rückseite Ihrer Gebrauchsanweisung die Serien-Nummer. Je nach Grillmodell finden Sie die Nummer auf dem Datensticker, welcher sich entweder am Grillgestell oder auf der Bodenplatte befindet. OUTDOORCHEF kann Garantie und Ersatzteil-lieferungen nur mit der Serien-Nummer bearbeiten.

Rover 570

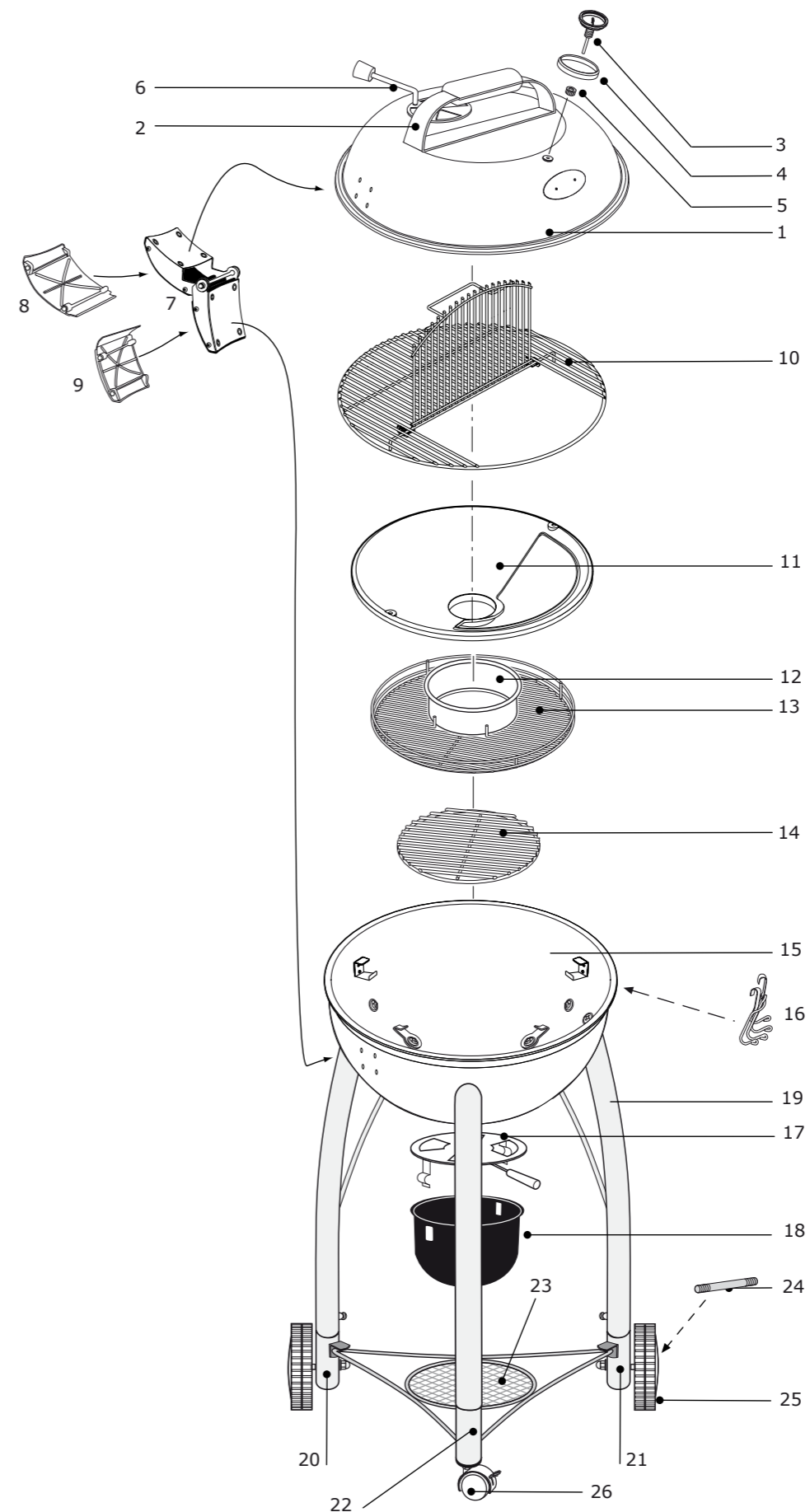

ROVER 570

Pos.	Art. Nr.	Description	Beschreibung
B		Lid	Deckel
B1	18.370.92	Protection washer lid handle	Schutz-Unterlagscheibe Deckelgriff
B2	18.370.76	Teflonwasher	U-Scheibe Teflon
B3	18.370.63	Washer	U-Scheibe
B4	18.370.43	Nut	Mutter

Pos.	Art. Nr.	Description	Beschreibung
C		Lid Hinge	Deckelscharnier
C1	18.332.27	Lid hinge axle	Deckelscharnierachse
C2	18.370.40	Dome Nut	Hutmutter
C3	18.370.63	Washer	U-Scheibe
C4	18.370.76	Teflonwasher	U-Scheibe Teflon
C5	18.370.28	Lid hinge cover screw	Deckelscharnier-Abdeckungsschrauben

Pos.	Art. Nr.	Description	Beschreibung
E		Bowl	Kugel
E1	18.370.07	Screw	Schraube
E2	18.370.63	Washer	U-Scheibe
E3	18.370.76	Teflonwasher	U-Scheibe Teflon
E4	18.370.84	Protection washer bowl	Schutz-Unterlagscheibe Kugel
E5	18.370.43	Nut	Mutter



ROVER 570

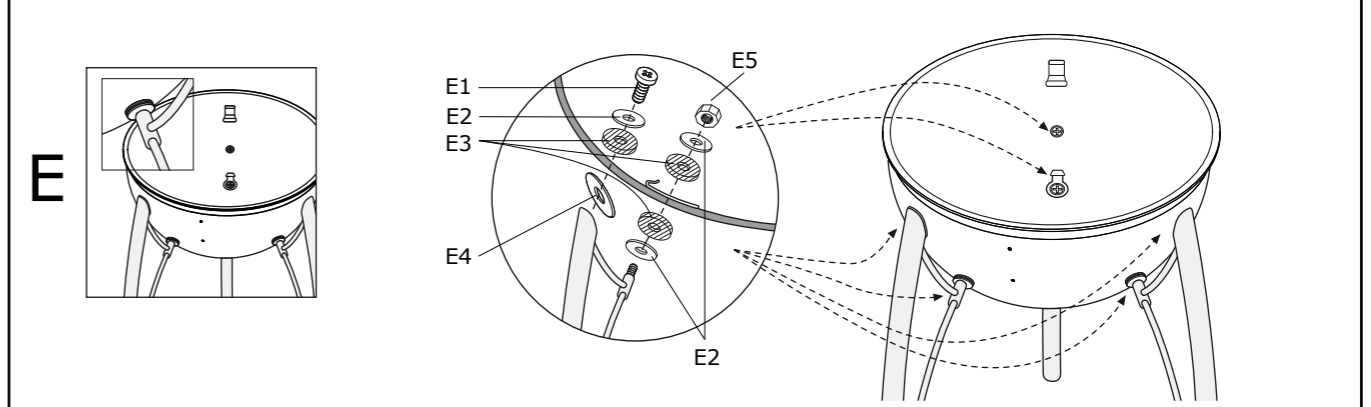
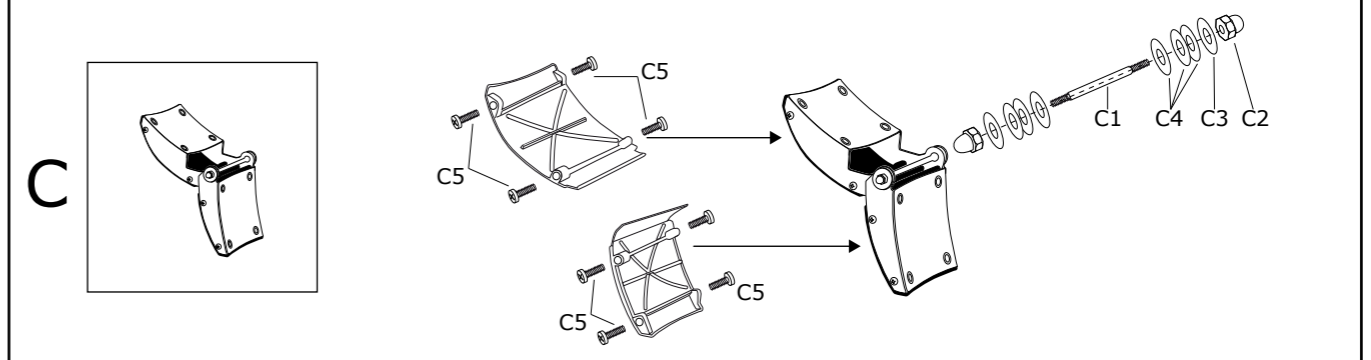
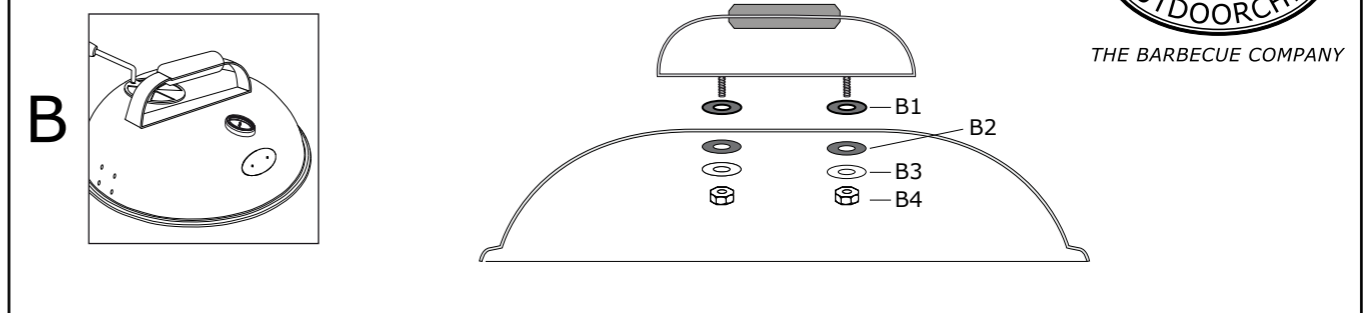



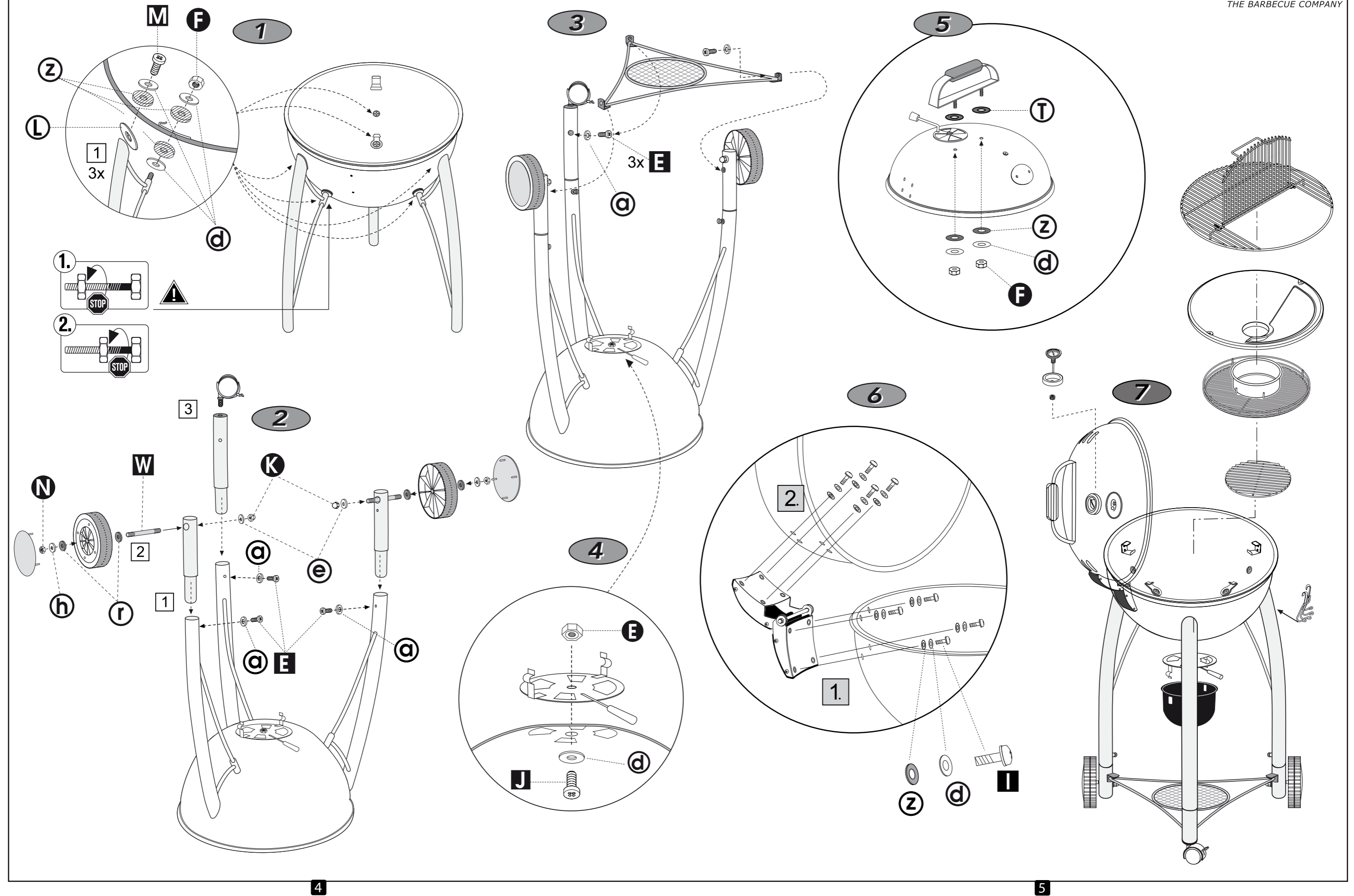





Rover 570



Rover 570 LH 18.379.10

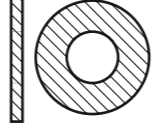
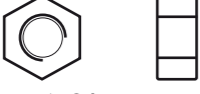
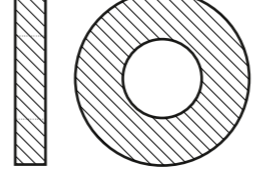
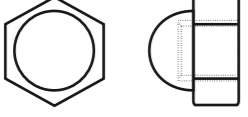
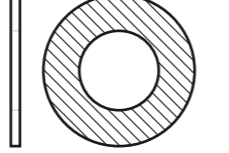
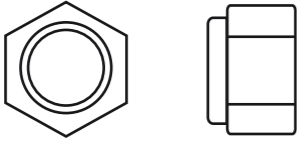

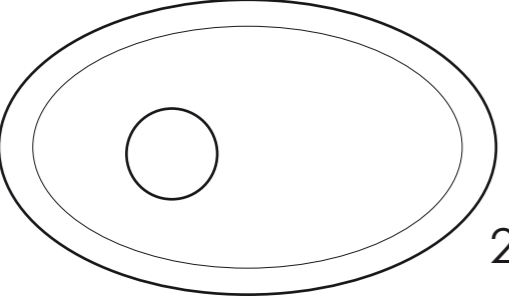
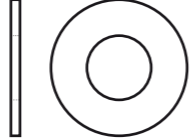
- 6x **E**  M5x12 (18.370.02)
- 1x **J**  M6x12 (18.370.04)
- 8x **I**  M5x16 (18.370.25)
- 20x **d**  18x6.4x1 (18.370.63)
- 3x **M**  M6x14 (18.370.07)
- 2x **h**  20x10.5x1.2 (18.370.67)
- 5x **F**  M6 Nut (18.370.43)
- 19x **z**  17x6.8x1.5 Teflon (18.370.76)
- 1x **E**  M6 Stop Nut (18.370.42)
- 2x **T**  23x11x4 Teflonwasher (18.370.92)
- 2x **K**  Dome Nut M8 (18.370.45)
- 4x **r**  20x10.5x1.2 (18.370.73)
- 2x **N**  M10 Lock Nut (18.370.47)
- 2x **W**  (18.370.16)
- 6x **a**  12x5.4x1 (18.370.60)
- 3x **L**  58x39 Washer (18.370.84)
- 2x **e**  18x8.5x1.2 (18.370.64)

to take notes
