

Easy Charcoal 480

Spare Parts

Ersatzteil-Liste

Pos.	Art. Nr.	Description	Beschreibung
1	18.355.45	Lid black	Deckel schwarz
2	18.332.28	Lid handle titan-silver	Deckelgriff titan-silber
3	18.850.13	Heat indicator °C/°F	Temperatur Anzeiger °C/°F
4	18.850.12	Heat indicator-Nut	Temperaturanzeiger-Befestigungsmutter
5	18.331.05	Upper Vent Disc with handle	Ventilationsschieber oben mit Griff
6	18.332.57	Cooking grid	Grillrost
7	18.330.02	Funnel	Trichter
8	18.330.04	Grease collector pan	Fettauffangschale
9	18.330.05	Charcoal grate	Kohlenrost
10	18.330.07	Booster grate	Anzünderoast
11	18.355.48	Bowl black	Kugel schwarz
12	18.330.46	Tool holder	Besteck Halter
13	18.332.56	Lower Vent disc with handle	Ventilationsschieber unten mit Griff
14	18.332.55	Ash Catcher	Aschenschale
15	18.332.38	Legs upper parts rear titan-silver	Beine Oberhälften hinten titan-silber
16	18.332.39	Leg upper part front titan-silver	Bein Oberhälfte vorne titan-silber
17	18.360.33	End cap upper part	Abschlusskappe oberer Teil
18	18.332.40	Leg lower part rear right titan-silver	Bein Unterhälfte hinten rechts titan-silber
19	18.332.41	Leg lower part rear left titan-silver	Bein Unterhälfte hinten links titan-silber
20	18.332.58	Leg lower part front titan-silver	Bein Unterhälfte vorne titan-silber
21	18.365.03	End cap under part	Abschlusskappe unterer Teil
22	18.332.59	Triangle titan-silver	Dreieck titan-silber
23	18.332.60	Bottom shelf	Bodenrost
24	18.332.01	Carry handle titan-silver	Handgriff titan-silber
25	18.365.08	Wheel	Rad
	18.379.11	Hardware set	Hardware set

Attention

Please write your serial number on the backside of the manual for future reference. You will find the number on the data plate attached to the trolley or the bottom plate depending on the grill model. OUTDOORCHEF can only supply spare parts and honour warranty returns when the serial number is available.

Achtung

Bitte notieren Sie auf der Rückseite Ihrer Gebrauchsanweisung die Serien-Nummer. Je nach Grillmodell finden Sie die Nummer auf dem Datensticker, welcher sich entweder am Grillgestell oder auf der Bodenplatte befindet. OUTDOORCHEF kann Garantie und Ersatzteil-lieferungen nur mit der Serien-Nummer bearbeiten.

Easy Charcoal 480

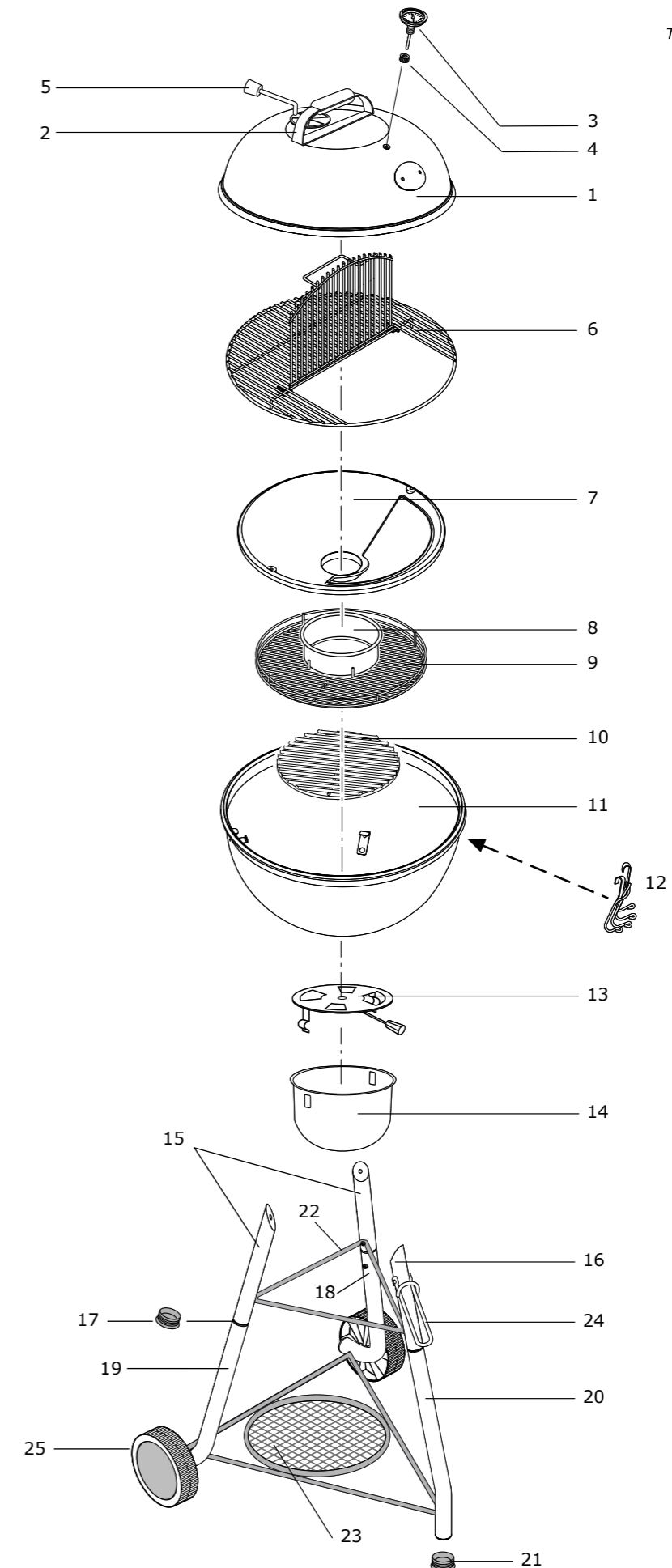

Easy Charcoal 480

B	Lid		Deckel
Pos.	Art. Nr.	Description	Beschreibung
B1	18.370.92	Protection washer lid handle	Schutz-Unterlagscheibe Deckelgriff
B2	18.370.76	Teflonwasher	U-Scheibe Teflon
B3	18.370.63	Washer	U-Scheibe
B4	18.370.43	Nut	Mutter



Easy Charcoal 480



B

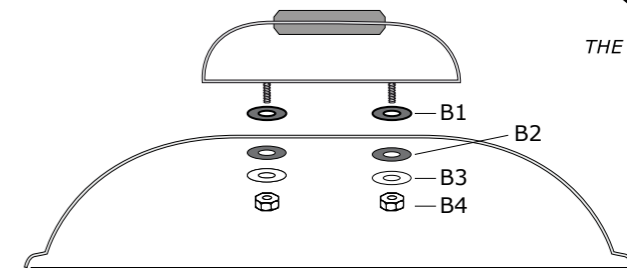
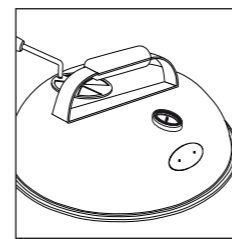



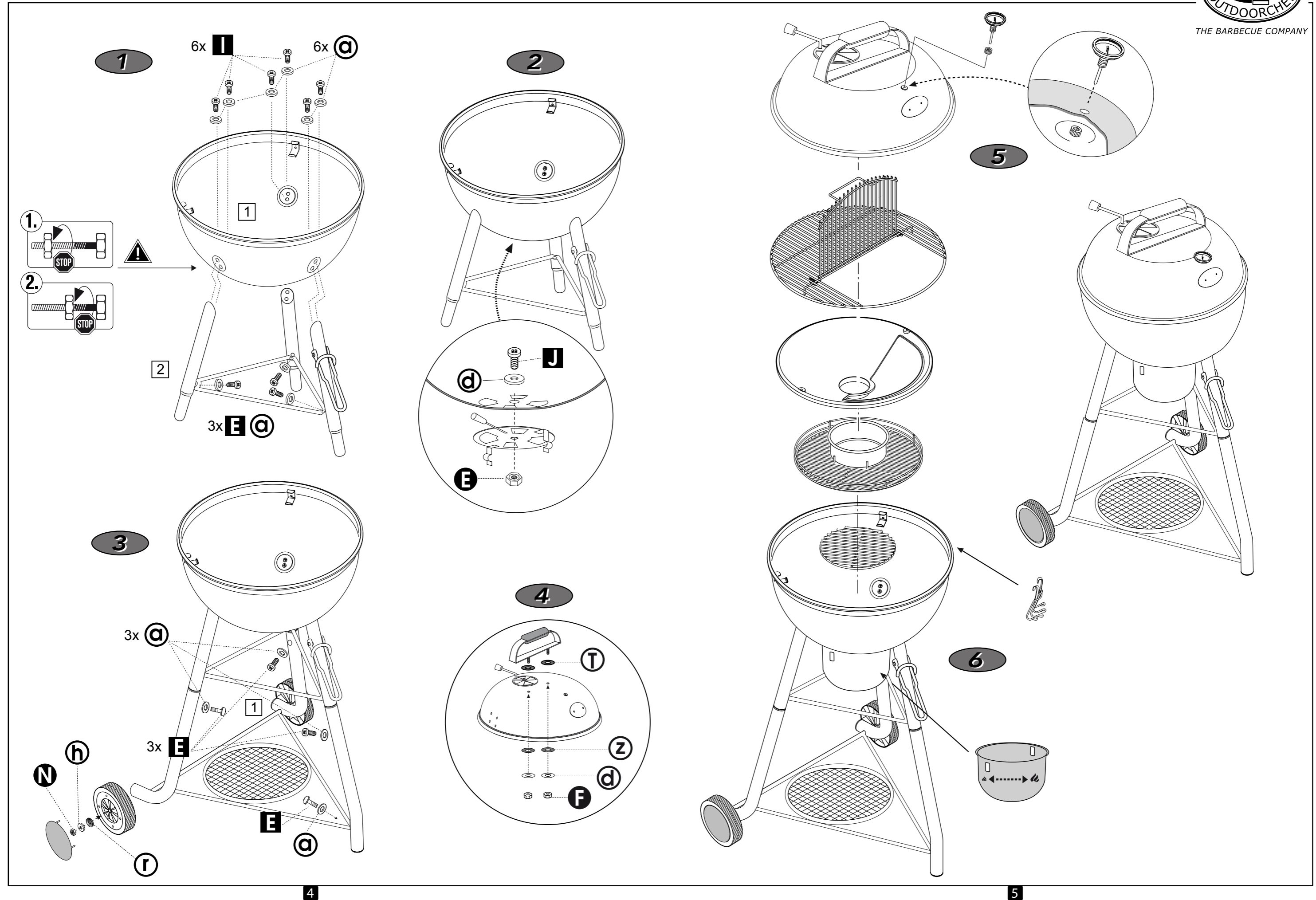





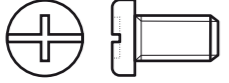

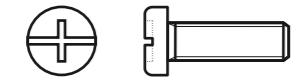
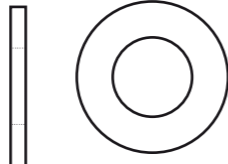
Easy Charcoal 480

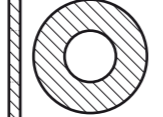

Easy Charcoal 480 18.379.11

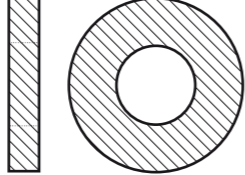

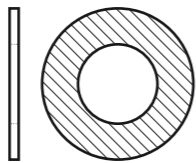
- 1x **J** 
M6x12 (18.370.04)
- 3x **d** 
18x6.4x1 (18.370.63)
- 6x **I** 
M5x16 (18.370.25)
- 2x **h** 
20x10.5x1.2 (18.370.67)
- 7x **E** 
M5x12 (18.370.02)
- 13x **a** 
12x5.4x1 (18.370.60)
- 2x **F** 
M6 Nut (18.370.43)
- 2x **z** 
17x6.8x1.5 Teflon (18.370.76)
- 1x **E** 
M6 Stop Nut (18.370.42)
- 2x **T** 
23x11x4 Teflonwasher (18.370.92)
- 2x **N** 
M10 Lock Nut (18.370.47)
- 2x **r** 
20x10.5x1.2 (18.370.73)

to take notes
