

CAMDEN 480 C

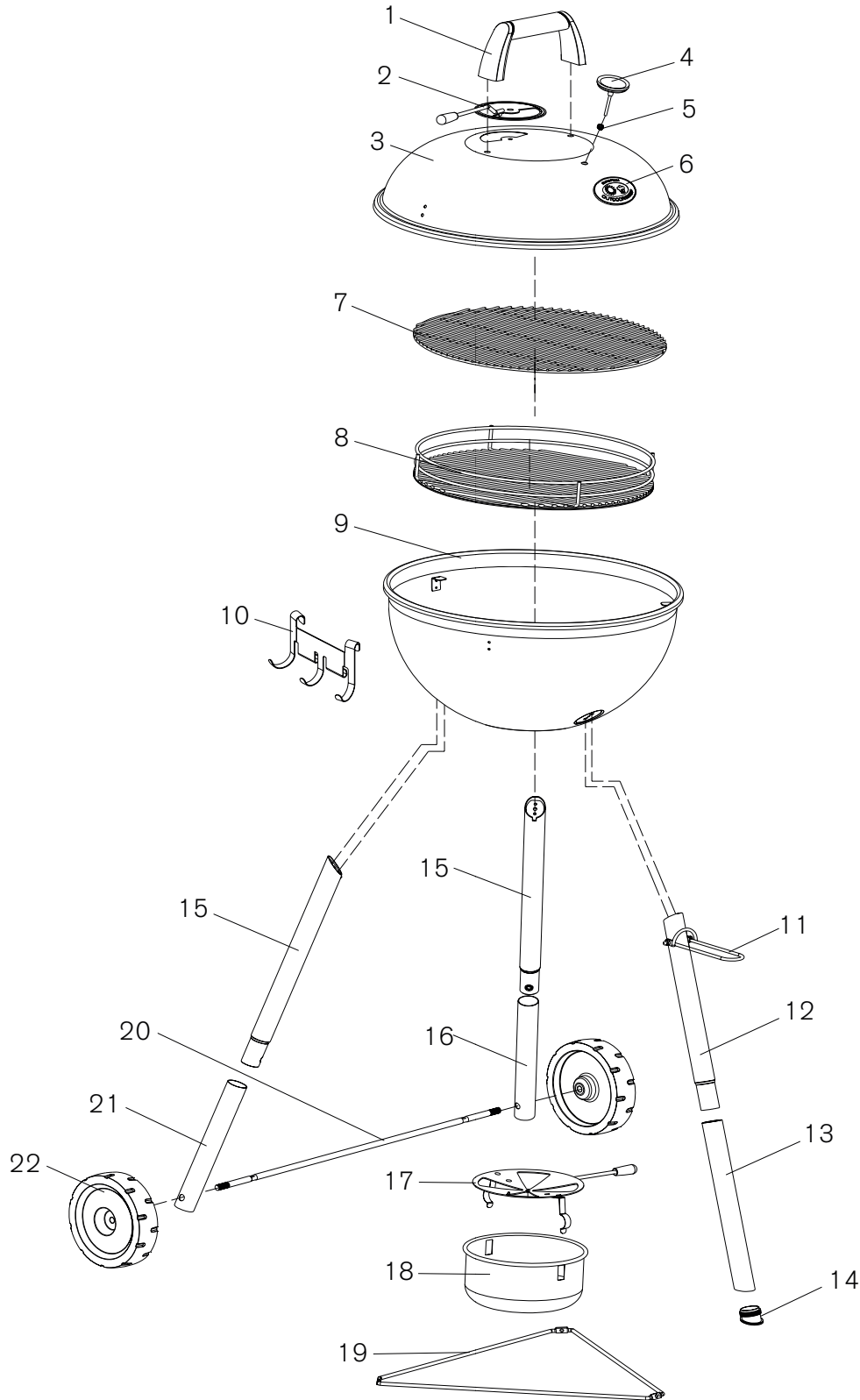

CAMDEN 480 C

B		LID	DECKEL
Pos.	Art. Nr.	Description	Beschreibung
B1	18.371.03	Teflonwasher	U-Scheibe Teflon
B2	18.371.02	Washer	U-Scheibe
B3	18.370.48	Nut	Mutter

B

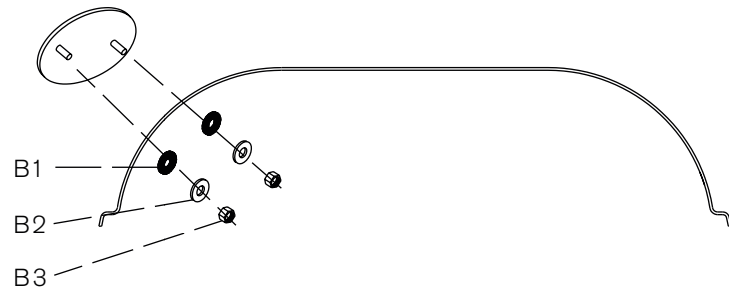
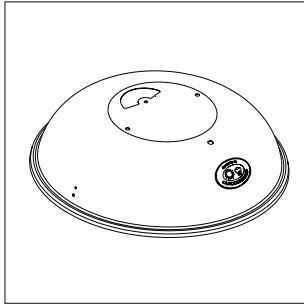

CAMDEN 480 C

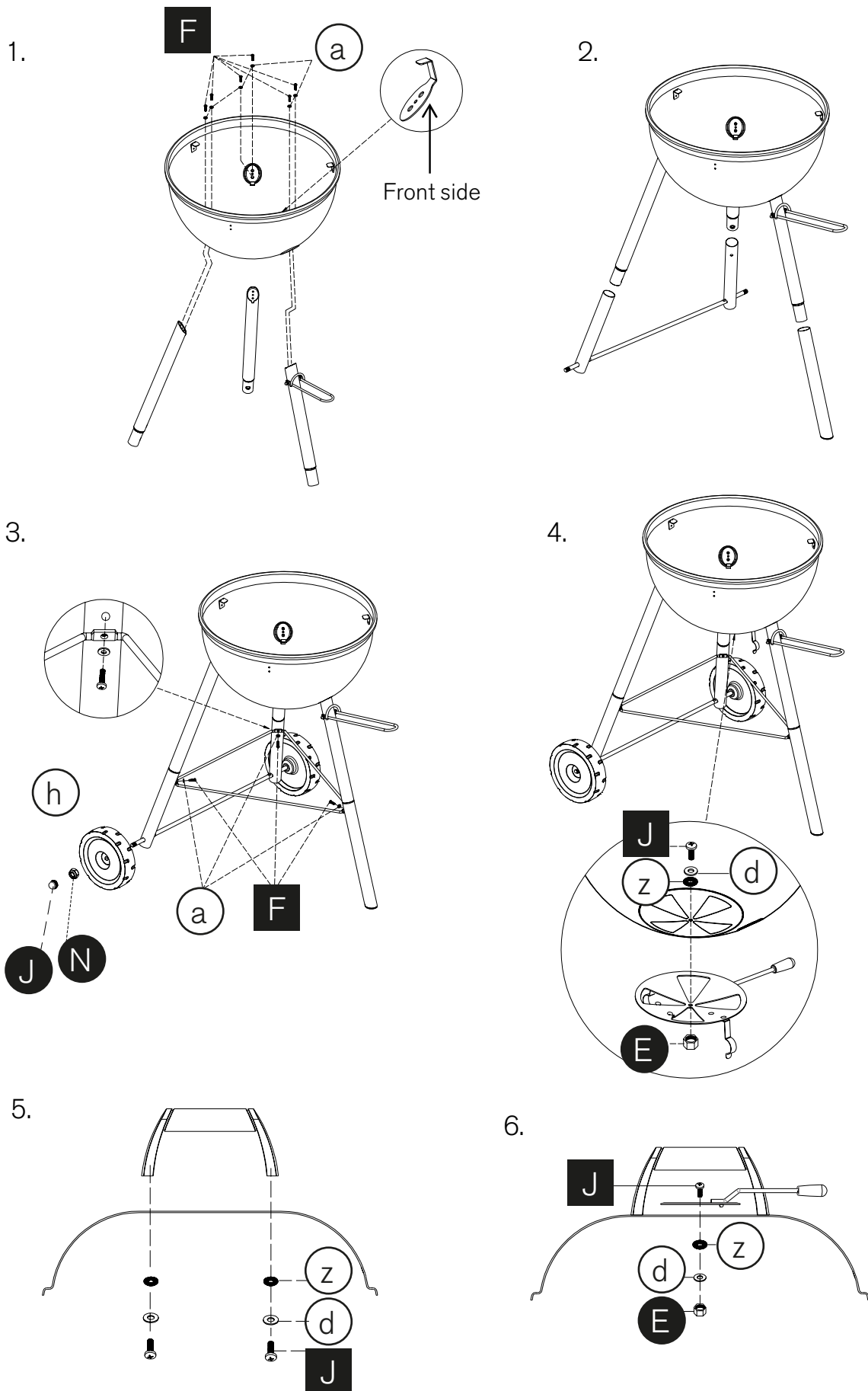

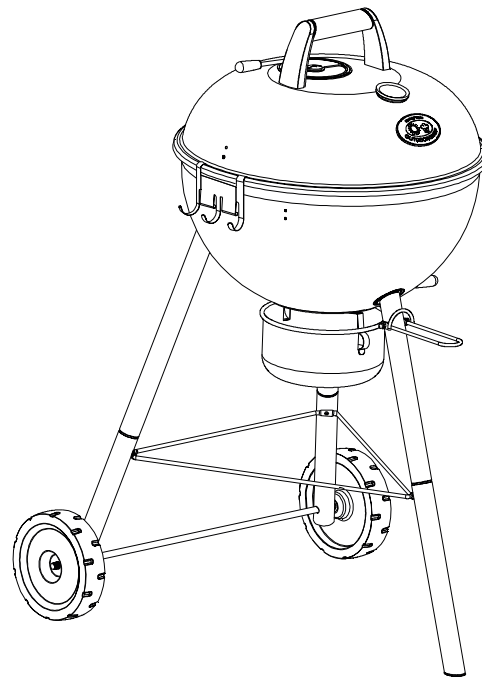
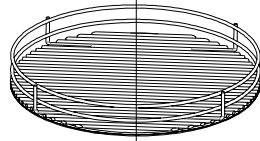
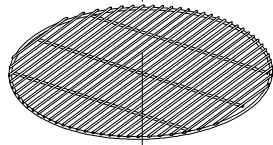
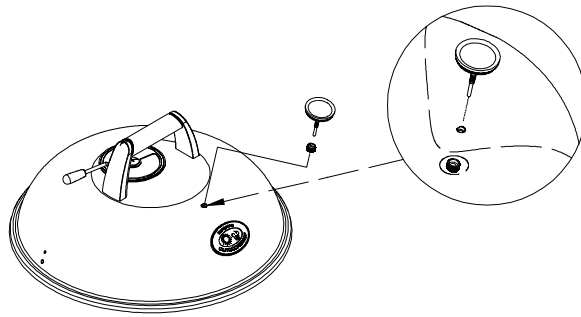

7.

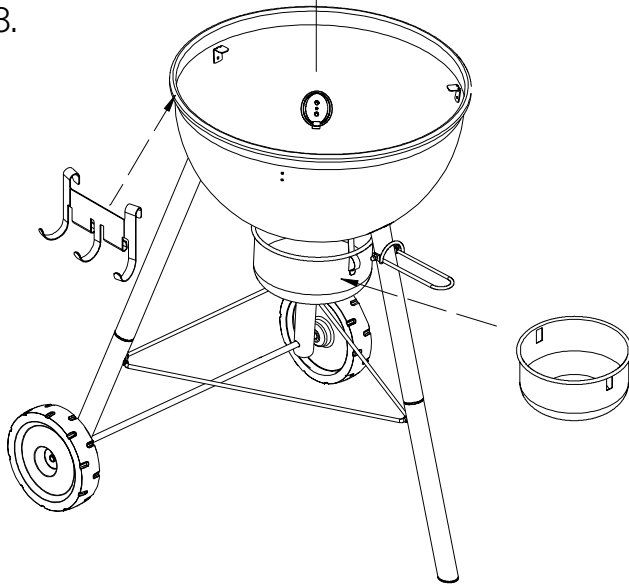

8.



	1x10 1x17
	1x2

CAMDEN 480 C

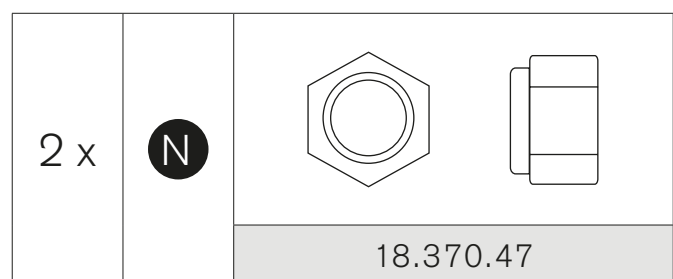
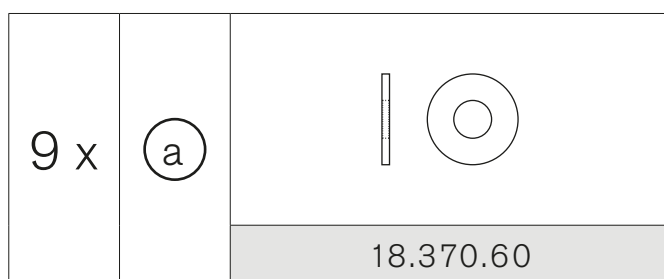
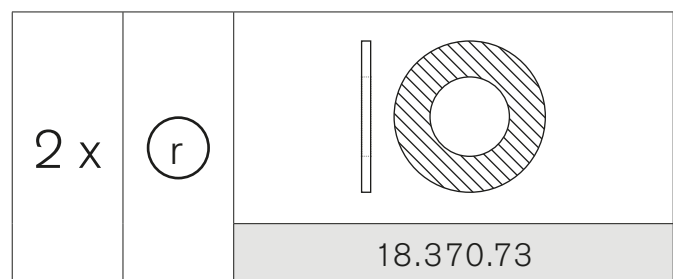
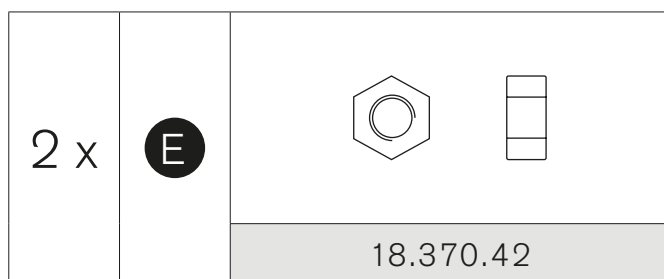
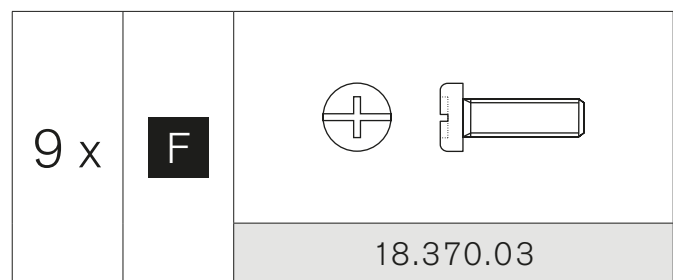
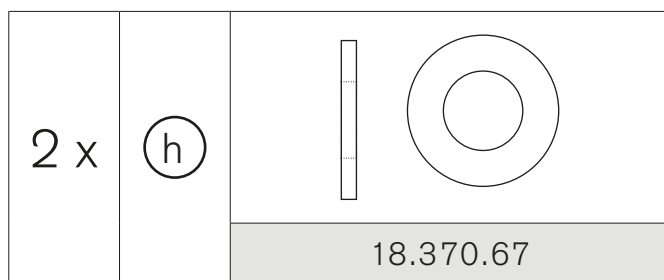
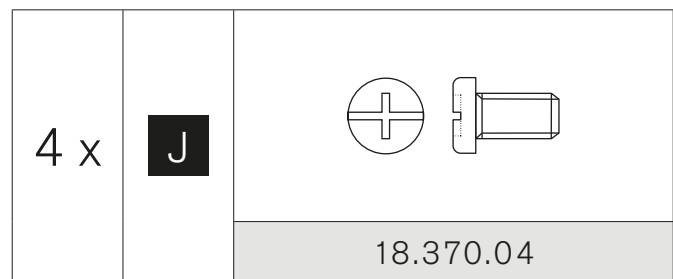
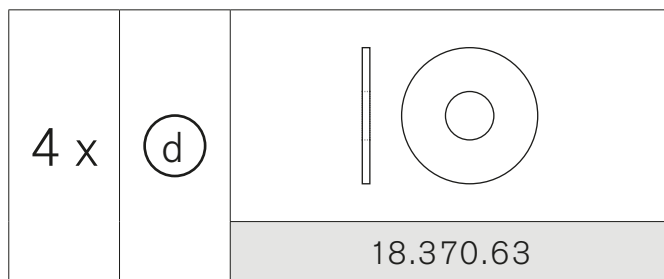
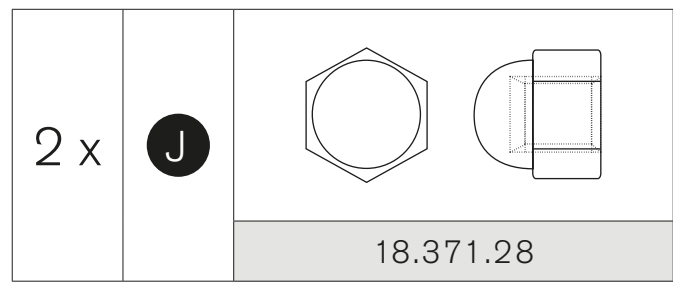
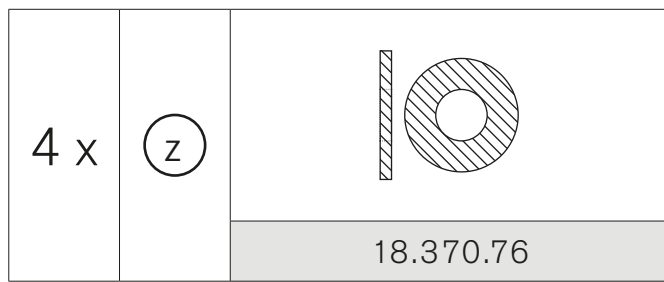

CAMDEN 480 C



SPAREPARTS			ERSATZTEIL-LISTE
Pos.	Art. Nr.	Description	Beschreibung
1	18.450.00	Lid handle bakelite	Deckelgriff Bakelit
2	18.420.06	Upper Vent Disc with handle	Ventilationsschieber oben mit Griff
3	18.430.00	Lid black	Deckel schwarz
4	18.850.21	Heat indicator °C/°F	Temperatur Anzeige °C/°F
5	18.850.12	Heat indicator-Nut	Temperaturanzeige-Befestigungsmutter
6	18.822.49	Logo plate	Logoplatte
7	18.420.41	Cooking grid	Grillrost
8	18.420.20	Charcoal grate	Kohlenrost
9	18.420.01	Bowl black	Kugel schwarz
10	18.420.05	Tool holder	Besteck Halter
11	18.420.15	Carry handle jetblack	Handgriff jetblack
12	18.420.10	Leg upper part front jetblack	Bein Oberhälfte vorne jetblack
13	18.420.13	Leg lower part front jetblack	Bein Unterhälfte vorne jetblack
14	18.450.01	End cap	Abschlusskappe
15	18.420.09	Legs upper part rear jetblack	Bein Oberhälfte hinten jetblack
16	18.420.11	Leg lower part rear right jetblack	Bein Unterhälfte hinten rechts jetblack
17	18.420.07	Lower vent disc with handle	Ventilationsschieber unten mit Griff
18	18.420.08	Ash catcher	Aschenschale
19	18.420.14	Stabilisation jetblack	Stabilisation jetblack
20	18.420.39	Wheel axle jetblack	Radachse jetblack
21	18.420.12	Leg lower part rear left jetblack	Bein Unterhälfte hinten links jetblack
22	18.450.02	Wheel	Rad
	18.379.36	Hardware set	Schraubenset

Please read the user guide carefully before using your OUTDOORCHEF Charcoal Kettle Barbeque.

Lesen Sie die Bedienungsanleitung sorgfältig durch, bevor Sie Ihren OUTDOORCHEF Holzkohle Kugelgrill in Betrieb nehmen.

Attention

Please write your serial number on the backside of the manual for future reference. You will find the number on the data plate attached to the trolley or the bottom plate depending on the grill model. OUTDOORCHEF can only supply spare parts and honour warranty returns when the serial number is available.

Achtung

Bitte notieren Sie auf der Rückseite Ihrer Gebrauchsanweisung die Serien-Nummer. Je nach Grillmodell finden Sie die Nummer auf dem Datensticker, welcher sich entweder am Grillgestell oder auf der Bodenplatte befindet. OUTDOORCHEF kann Garantie und Ersatzteillieferungen nur mit der Serien-Nummer bearbeiten.

DKB Household Switzerland AG operates a policy of continuous product development and improvement.

As such we reserve the right to alter product design and or technical specification without giving any prior notice.