



**YOU'RE IN CHARGE**  
AND WE MAKE IT SIMPLE



# YOU'RE IN CHARGE AND WE MAKE IT SIMPLE

Let pond boss® help you be in charge of your water feature. We specialize in premium quality water gardening products to create, maintain, and enhance your fish or turtle pond, fountain, or waterfall feature.



Products marked with this icon are perfect to use in aquaponics and hydroponics systems.



Products marked with this icon can be used in turtle ponds, biotopes, and tanks.



Products marked with this icon are energy savers and have an eco-friendly design.

## EASY TO USE PRODUCTS, ENDLESS POSSIBILITIES

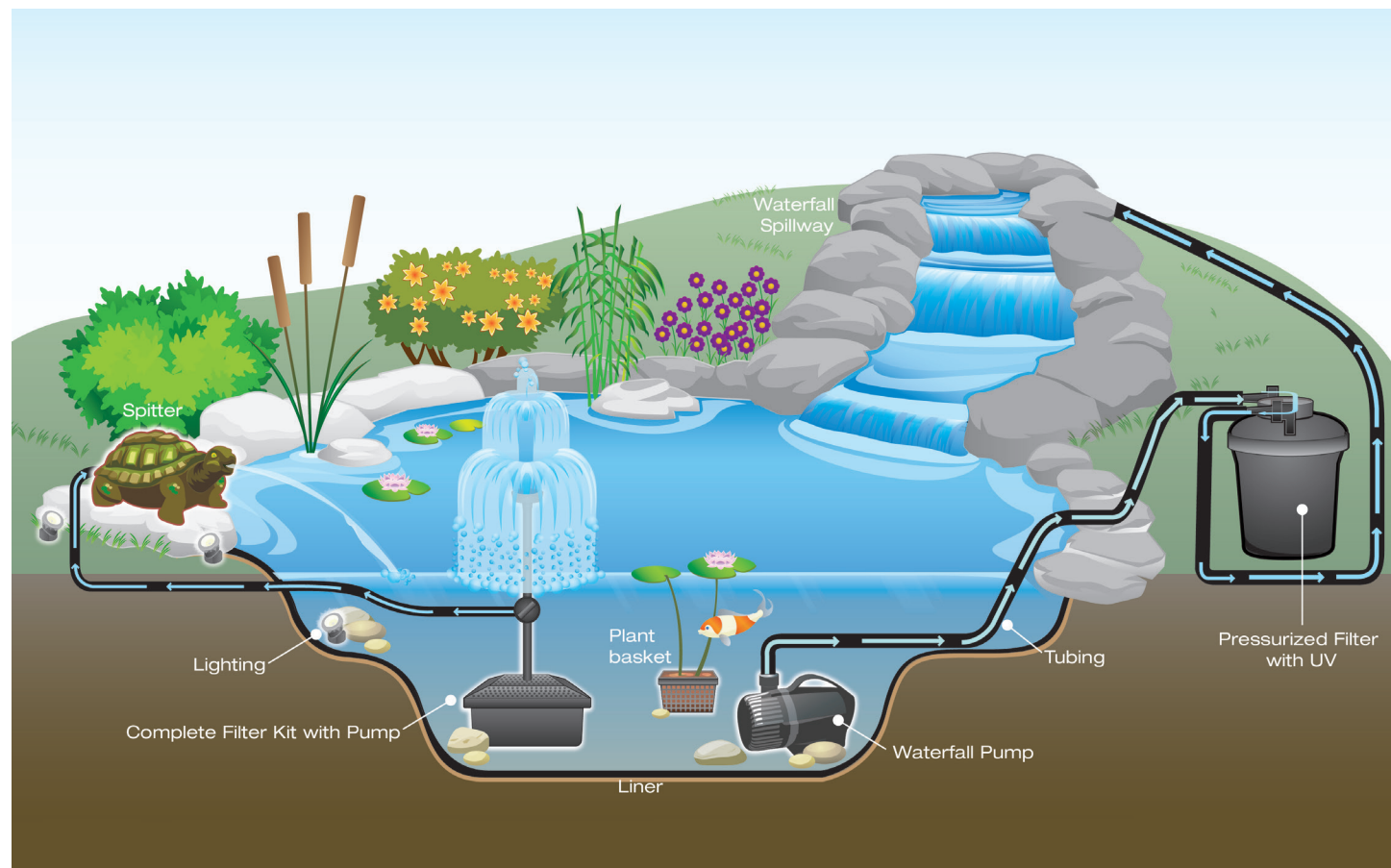

Learn more about pond boss® products at [www.thepondboss.net](http://www.thepondboss.net)

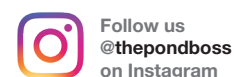

# TABLE OF CONTENTS

## PUMPS..... 4

pond boss® carries a superior line of pumps for your pond, fountain, or waterfall. Comprised of state of the art technology, our pumps deliver unmatched performance and reliability at affordable prices.

## FILTRATION..... 11

Filtration is a critical component of any water garden or pond since it promotes a healthy and ecologically stable pond environment. pond boss® filtration equipment ensures a thriving ecosystem for fish and plants. Algae and harmful bacteria won't stand a chance with the right filtration.

## WATER TREATMENTS..... 16

To maintain a clean, healthy, and well balanced ecosystem for your pond or water garden, dependable water treatments are necessary. pond boss® has a line of treatments for algae control, chlorine removal, and other methods of water stabilization.

## MAINTENANCE..... 17

Maintaining a clean and healthy pond environment is simple and easy thanks to pond boss®. Our products allow you to clean your pond without the hard labor of draining your pond and starting over.

## CONSTRUCTION..... 18

The construction of a pond requires the use of quality materials that are built to last and provide satisfactory results. Liners, accessories, and tubing are critical for the development, maintenance, and dependability of a pond.

## WATER FEATURES..... 19

Adding a waterfall to your pond is easier than you think. pond boss® spillways will enhance the beauty of your water garden or pond.

## ACCENTS..... 20

pond boss® can help add appeal to your water feature. With a variety of nozzle kits, spitters, lighting, and other decorative items, you can easily accessorize your pond.

### KEY FEATURES:

- Energy efficient designs
- Oil free, magnetic drive pumps
- Epoxy encapsulated, fully submersible
- Built-in variable flow control
- Suction cups for mounting
- Quiet operation
- 1 year limited warranty



### KEY FEATURES:

- Internal low water auto shut-off sensor, prevents pump burnout
- Energy efficient design
- Oil free, magnetic drive pumps
- Epoxy encapsulated, fully submersible
- Built-in variable flow control
- Suction cups for mounting
- Quiet operation
- 1 year limited warranty



#### 50 GPH Fountain Pump

Item# 52769  
UPC: 871980005619

- Ideal for tabletop fountains
- 1 ft. ideal pumping height
- 50 Gallons per Hour (max.)
- 6 ft. cord length
- Fits 3/8 in. ID tubing (not included)
- 2.7 watts
- 0.04 amps
- UL listed pump



#### 90 GPH Fountain Pump

Item# 52714  
UPC: 871980005053

- Ideal for tabletop and small fountains
- 1-2 ft. ideal pumping height
- 90 Gallons per Hour (max.)
- 6 ft. cord length
- Fits 3/8 and 1/2 in. ID tubing (not included)
- 5 watts
- 0.06 amps
- ETL listed pump



#### 150 GPH Fountain Pump

Item# 52712  
UPC: 871980005114

- Ideal for small fountains
- 2-3 ft. ideal pumping height
- 150 Gallons per Hour (max.)
- 6 ft. cord length
- Fits 3/8 and 1/2 in. ID tubing (not included)
- 7 watts
- 0.1 amps
- ETL listed pump



#### 170 GPH Fountain Pump

Item# 52341  
UPC: 871980012686

- Ideal for small fountains
- Up to 2-3 ft. ideal pumping height
- 170 Gallons per Hour (max.)
- 16 ft. cord length
- Fits 1/2 in. ID tubing (not included)
- 10 watts
- 0.12 amps
- ETL listed pump



#### 170 GPH Fountain Pump with Light

Item# 52768  
UPC: 871980005602

- Ideal for small fountains
- Up to 2-3 ft. ideal pumping height
- 170 Gallons per Hour (max.)
- Single, detachable, LED light included
- 16 ft. cord length
- Fits 1/2 in. ID tubing (not included)
- 10 watts
- 0.12 amps
- ETL listed pump



#### 320 GPH Fountain Pump

Item# 52710  
UPC: 871980005039

- Ideal for medium to large fountains
- 3-5 ft. ideal pumping height
- 320 Gallons per Hour (max.)
- 16 ft. cord length
- Fits 1/2 and 3/4 in. ID tubing (not included)
- 23 watts
- 0.4 amps
- ETL listed pump



#### 525 GPH Fountain Pump

Item# 52713  
UPC: 871980005046

- Ideal for large fountains
- 5-7 ft. ideal pumping height
- 525 Gallons per Hour (max.)
- 16 ft. cord length
- Fits 1/2, 5/8, and 3/4 in. ID tubing (not included)
- 42 watts
- 0.6 amps
- ETL listed pump

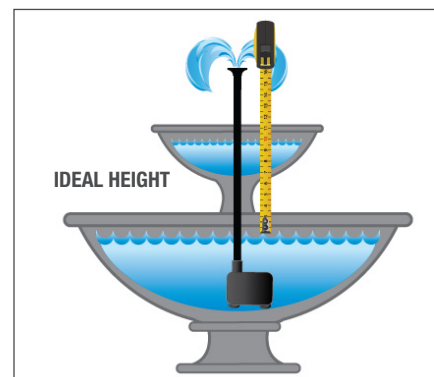

### TIP:

To determine pumping height, measure from water line up. When in doubt, more pumping height is better since you can adjust the flow with our flow control feature.



#### 435 GPH Fountain Pump

Item# 52342  
UPC: 871980012716

- Ideal for large fountains
- Up to 3-5 ft. ideal pumping height
- 435 Gallons per Hour (max.)
- 16 ft. cord length
- Fits 1/2 in. ID tubing (not included)
- 40 watts
- 0.55 amps
- ETL listed pump



#### 435 GPH Fountain Pump with Light

Item# 52343  
UPC: 871980012723

- Ideal for large fountains
- Up to 3-5 ft. ideal pumping height
- 435 Gallons per Hour (max.)
- Single, detachable, LED light included
- 16 ft. cord length
- Fits 1/2 in. ID tubing (not included)
- 40 watts
- 0.55 amps
- ETL listed pump

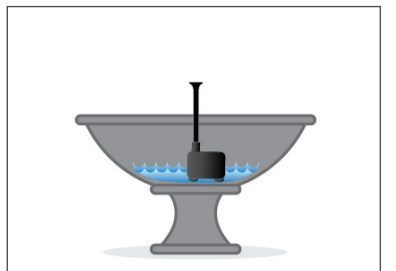

1. If the water level drops below the center of the pump, a sensor detects that there is low water and automatically turns off the pump.



2. Once water is added, the sensor detects the presence of water and automatically turns the pump back on.

### KEY FEATURES:

- Energy efficient design
- Oil free, epoxy encapsulated, fully submersible
- Flow control
- Ceramic shaft and bearings
- Quiet operation
- 16 ft. cord length
- Safe for fish and plants
- 3 year limited warranty



#### 280 GPH Pond Pump

Item# 52354  
UPC: 871980012785

- Ideal for ponds up to 200 gallons
- Approximate pond size: 3 ft. x 6 ft. x 1.5 ft.
- 280 Gallons per Hour (max.)
- 7.8 ft. max. pumping height
- Fits 3/4 in. ID tubing (not included)
- 27 watts
- 0.45 amps
- ETL listed pump



#### 420 GPH Pond Pump

Item# 52718  
UPC: 871980005060

- Ideal for ponds up to 400 gallons
- Approximate pond size: 6 ft. x 9 ft. x 1.5 ft.
- 420 Gallons per Hour (max.)
- 11.5 ft. max. pumping height
- Fits 3/4 in. ID tubing (not included)
- 42 watts
- 0.8 amps
- ETL listed pump



#### 630 GPH Pond Pump

Item# 52716  
UPC: 871980005077

- Ideal for ponds up to 600 gallons
- Approximate pond size: 9 ft. x 16 ft. x 1.5 ft.
- 630 Gallons per Hour (max.)
- 13.2 ft. max. pumping height
- Fits 3/4 in. ID tubing (not included)
- 40 watts
- 0.6 amps
- ETL listed pump



#### 800 GPH Pond Pump

Item# 52770  
UPC: 871980005626

- Ideal for ponds up to 800 gallons
- Approximate pond size: 9ft. x 16ft. x 1.5 ft.
- 800 Gallons per Hour (max.)
- 13.9 ft. max. pumping height
- Fits 3/4 in. ID tubing (not included)
- 52 watts
- 1 amps
- ETL listed pump

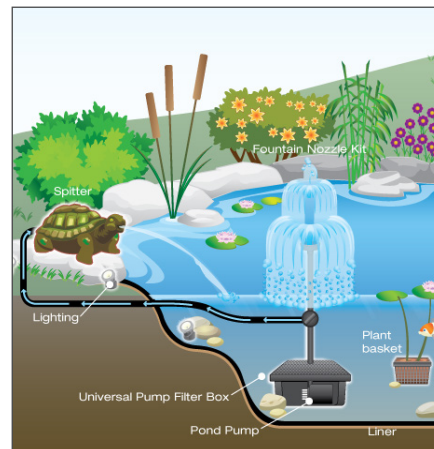

### TIP:

**How to choose your Pond Pump:**  
For best results, the pump you select should circulate the volume of water in your pond in 1 hour. Know the volume of your pond:

**Rectangular:** Avg. L (ft.) x Avg. W (ft.) x Avg. D (ft.) x 7.5 = total gallons

**Rectangular:** Avg. L (ft.) x Avg. W (ft.) x Avg. D (ft.) x 5.9 = total gallons

### KEY FEATURES:

- Self-cleaning design
- Superior energy efficient design
- Oil free, epoxy encapsulated, fully submersible
- Quiet operation
- 16 ft. cord length
- Safe for fish and plants
- 3 year limited warranty

#### PUMPSHIELD® INCLUDED

Protective mesh barrier bag



#### 1350 GPH Waterfall Pump

Item# 52717  
UPC: 871980005145

- Ideal for waterfalls up to 5 ft. in height
- 16 ft. max. pumping height
- 1350 Gallons per Hour (max.)
- Fits 1 in. ID tubing (not included)
- 1 1/4 in. NPT
- 75 watts
- 0.85 amps
- ETL listed pump



#### 2300 GPH Waterfall Pump

Item# 52719  
UPC: 871980005152

- Ideal for waterfalls up to 10 ft. in height
- 20 ft. max. pumping height
- 2300 Gallons per Hour (max.)
- Fits 1 and 1 1/2 in. ID tubing (not included)
- 1 1/4 in. NPT
- 130 watts
- 1.5 amps
- ETL listed pump



#### 3600 GPH Waterfall Pump

Item# 52353  
UPC: 871980012884

- Ideal for waterfalls up to 15 ft. in height
- 21 ft. max. pumping height
- 3600 Gallons per Hour (max.)
- Fits 1 1/2 and 2 in. ID tubing (not included)
- 1 1/2 in. threaded outlet
- 170 watts
- 1.8 amps
- ETL listed pump



#### 5000 GPH Waterfall Pump

Item# 52355  
UPC: 871980012891

- Ideal for waterfalls up to 18 ft. in height
- 23 ft. max. pumping height
- 5000 Gallons per Hour (max.)
- Fits 1 1/2 and 2 in. ID tubing (not included)
- 2 in. threaded outlet
- 230 watts
- 2.5 amps
- ETL listed pump

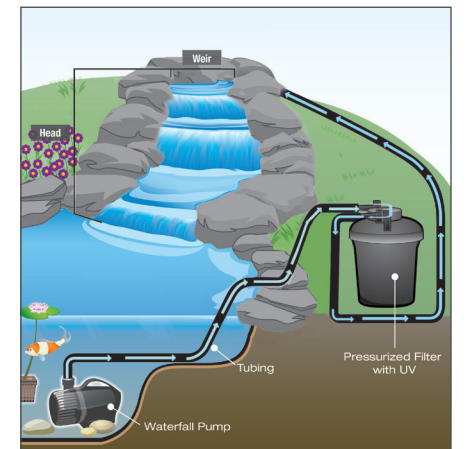

### TIP:

**How to choose your Waterfall Pump:** The rule of thumb is for every 1 in. of weir width you need 100 gallons per hour flow to achieve a "Sheet" look.

- Divide by two for a "Trickle" look
- Multiply by two for a "Niagara" look

Be sure to check the pump's specifications for the ideal pumping height of your pump at the head of your waterfall. Keep in mind excessive bend or in-line filters will reduce the flow.

# PUMPS

## WATERFALL

### KEY FEATURES:

- High performance
- Sturdy asynchronous motor, vortex impeller
- Submersible or inline use
- Water-cooled ceramic bearings
- Oil-free, epoxy encapsulated
- Safe for fish and plants
- 20 ft. cord length
- 3 year limited warranty



### 8000 GPH Waterfall Pump

Item# 52581

UPC: 871980004452

- Ideal for waterfalls up to 22 ft. in height
- 29.5 ft. max. pumping height
- 8000 Gallons per Hour (max.)
- Fits 1 1/2 and 2 in. ID tubing (not included)
- 2 in. threaded outlet
- 600 watts
- 4.8 amps
- UL listed

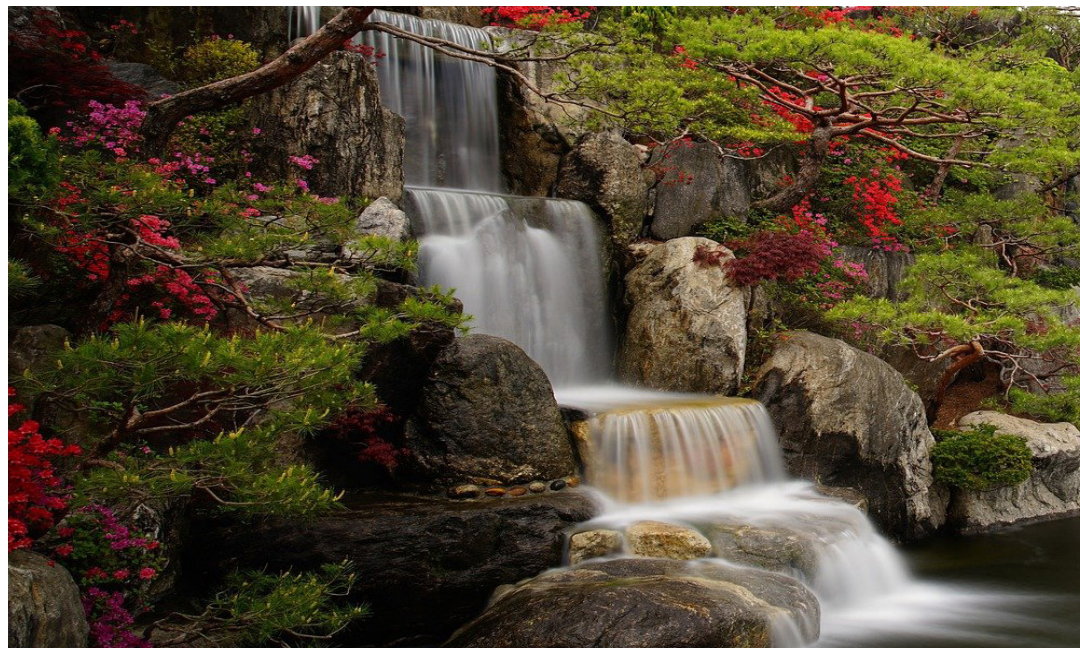
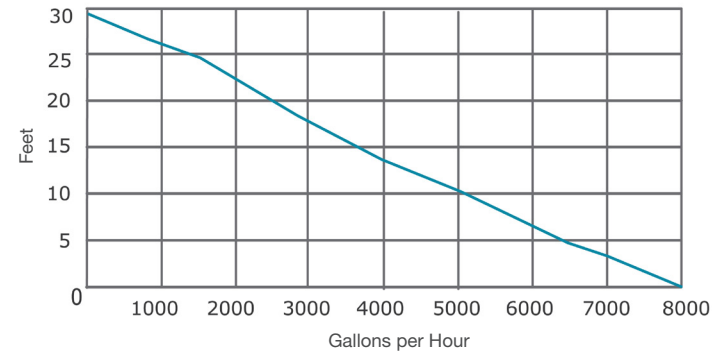

## SPECIALTY FOUNTAIN

### KEY FEATURES:

- Aerates and decorates large ponds
- 3 fountain heads included (Trumpet, Single Tier, 3-Tier)
- Three 1 watt LED lights with dusk-to-dawn sensor
- Anti-clog technology
- Low-profile float design
- Minimum operating depth of 2.5 ft.
- Safe for fish and plants
- 50 ft. cord length
- 3 year limited warranty



### Floating Fountain with Lights

Item# 52595

UPC: 871980004162

- For ponds up to 1/4 acre
- 1/4 Horsepower
- Powerful, energy efficient 2300 GPH pump
- Epoxy encapsulated, fully submersible
- Durable, ceramic shaft & bearing construction
- 100 ft. mooring line included
- 120V / 60Hz
- 130 watts / 1.5 amps
- 3 year limited warranty
- ETL listed pump and UL listed transformer



**Single Tier** Dimensions: 16 ft. diameter  
10 ft. height



**Trumpet** Dimensions: 15.75 ft. diameter  
3.6 ft. height



**3-Tier** Dimensions: 6.5 ft. diameter  
10 ft. height

# PUMPS

## SPECIALTY FOUNTAIN

### KEY FEATURES:

- Aerates and decorates ponds
- Waterspray nozzle
- 12 LED lights with dusk-to-dawn sensor
- Floats at pond surface
- Minimum operating depth of 11 in.
- Safe for fish and plants
- 16 ft. cord length
- 1 year limited warranty

### PUMPSHIELD® INCLUDED

Protective mesh barrier bag



### Floating Fountain with White LED Lights

Item# 75976

UPC: 871980010972

- For ponds up to 750 gallons
- 400 GPH pump
- Energy efficient design
- Anchor ring allows you to secure the fountain in your pond
- 120V / 60Hz
- 40 watts / 0.55 amps
- 1 year limited warranty
- ETL listed pump



**Waterspray** Dimensions: 3.3 ft. diameter  
5.25 ft. height

# WATER FEATURES

## WATERFALL SPILLWAY

### KEY FEATURES:

- Creates a beautiful waterfall or a disappearing water feature.
- Durable, UV resistant, high impact plastic.
- Extended spillway for easy installation.

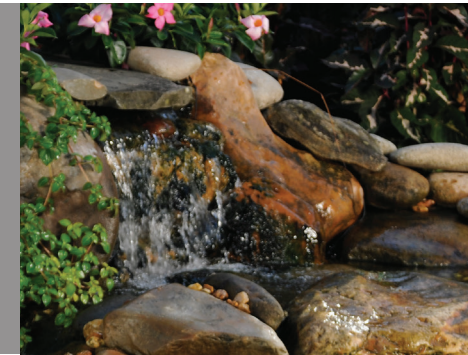

### 8 in. Waterfall Spillway

Item# 52726

UPC: 871980005176

- 8 in. spillway
- Fits 3/4 and 1 in. ID tubing (not included)
- Use with your choice of pond boss® pump between 800-2500 GPH (not included)
- Dimensions: 14.4 in. x 10.33 in. x 6 in.



EASILY ADD A WATERFALL TO YOUR POND

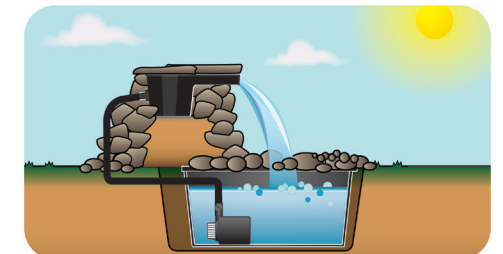

CREATE A DISAPPEARING WATER FEATURE

### EASY INSTALLATION



1. Determine the height of your waterfall



2. Place the spillway based on your measurements



3. Connect the pump and place the pump in the pond



4. Decorate the spillway with rocks

# FILTRATION

## FILTER KIT WITH PUMP

### KEY FEATURES:

- Pumps and cleans water
- Includes energy efficient 320 GPH pump
- Nozzle kit included
- Sloped lid prevents accumulation of debris
- Promotes growth of beneficial bacteria
- Flow control
- Diverter valve allows an additional water feature to be operated using the included pump
- The combined set costs less than purchasing a filter, pump, and nozzle kit separately



### Medium Filter Kit with Pump

Item# 52734  
UPC: 871980005374

- Ideal for use in ponds up to 500 gallons
- Protects pump from debris
- Earth-friendly biological filter
- Diverter Valve fits 1/2 in. ID tubing (not included)
- Runs on a single cord (16 ft. length)
- Dimensions: 12.2 x 6.3 x 21.9 in.
- 320 GPH pump with a 6.2 ft. maximum pumping height
- ETL listed pump
- 1 year limited warranty



Filter Pads should be changed once a year for maximum efficiency.

### Replacement Filter Pads for 52720 and 52734

Item# 52773  
UPC: 871980005589

- Contains a coarse and a fine filter
- Safe for fish and plants

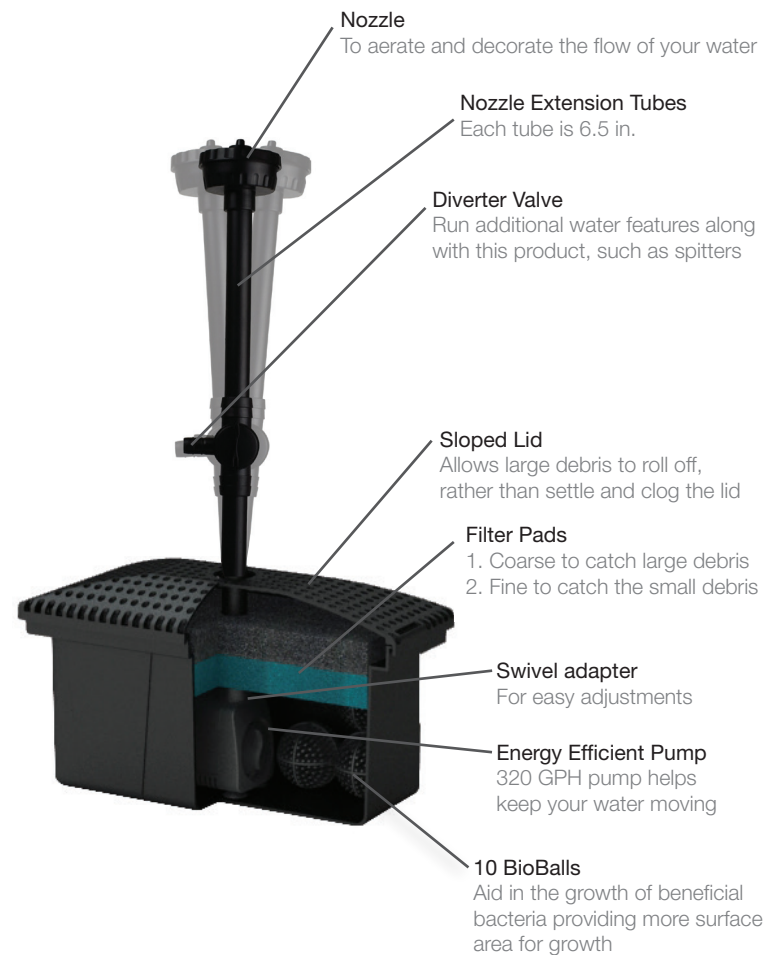

# FILTRATION

## PUMP FILTERS

### PROTECT YOUR PUMP

Help extend the life of your pump by protecting it with our range of pump filtration. Each of these filters will prolong the life of your pump by preventing debris from entering and clogging it.



### Universal Filter Box

Item# 52720  
UPC: 871980005022

- Ideal for use in ponds up to 500 gallons
- Cleans water
- Protects pump from debris
- Promotes growth of beneficial bacteria
- Includes coarse filter pad, fine filter pad and bioballs
- Use with your choice of pond boss® pump between 225-800 GPH (not included)
- Safe for fish and plants
- Dimensions: 12.25 in. x 6.25 in. x 6 in.



Filter Pads should be changed once a season for maximum efficiency.

### Replacement Filter Pads for 52720 and 52734

Item# 52773  
UPC: 871980005589

- Contains a coarse and a fine filter
- Safe for fish and plants



### pumpshield®

Item# 52552  
UPC: 871980306280

- Keeps harmful debris out of your pump
- Extends the life of your pump
- Industrial grade mesh material
- Reduces maintenance by preventing your pump from clogging
- Works with submersible pumps (pump not included)
- Safe for fish and plants

# FILTRATION

## UV POND CLARIFIER

### HOW DOES IT WORK?

1. The pump pushes water through the inlet and into the UV clarifier.
2. Water is pumped through the carefully calibrated UV chamber at the right speed to ensure maximum exposure to UV light to clear the green out of the water.
3. Clean water exits the clarifier through the outlet and back into your pond.

### WHY ULTRAVIOLET (UV)?

Ultraviolet Light (UV) Technology has been used for years in high-end Koi and fish farms to ensure water clarity and a healthy pond environment for both plants and fish. The ultraviolet bulb cleans the green out of the water, thereby reducing the need for chemicals.



#### 9 Watt UV Pond Clarifier

Item# 52735  
UPC: 87198005404

- For use with ponds up to 2000 gallons
- Cleans the green out of the water
- Uses ultraviolet technology to clean pond water
- Helps balance the pond and maintain clean water
- Helps keep fish healthy
- Prevents nasty odors and murky water
- 9 watt UV bulb lasts up to 8000 hours
- Continuously improves water quality
- Energy efficient
- Fits 1/2, 3/4 and 1 in. ID tubing (not included)
- Use with your choice of pond boss® pump between 225-800 GPH (not included)
- 16 ft. cord length
- 115V/60Hz
- ETL listed

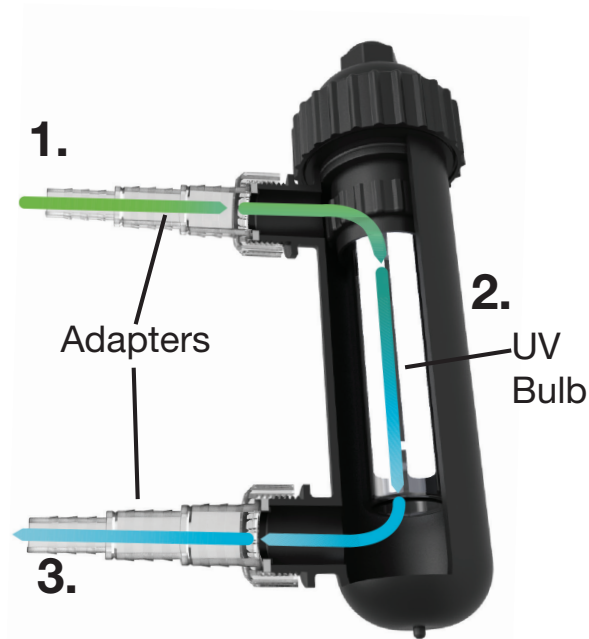

UV Bulb should be changed once a season for maximum efficiency.

#### 9W UV Replacement Bulb

Item# 52364  
UPC: 871980012570  
• Replaces 9 watt UV Bulb  
• 8000 hours of life

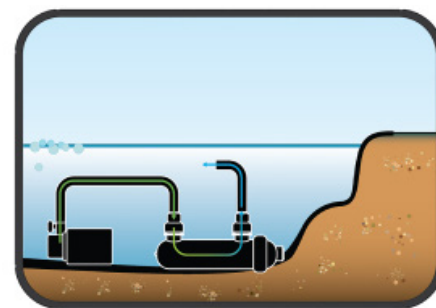

CAN BE USED IN YOUR POND

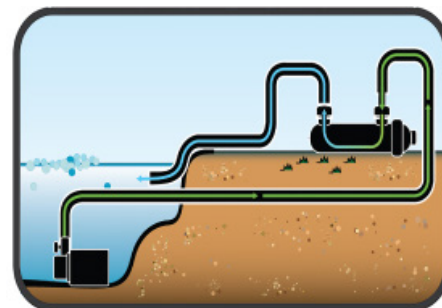

CAN BE USED OUT OF YOUR POND

## PRESSURIZED POND FILTERS

### HOW DOES IT WORK?

- Your pump pushes water through the inlet and into the filter.
- The pressurized system forces water through the filter pads ensuring maximum cleaning power to remove particles.
- The water then flows over the bio balls, which help grow beneficial bacteria that aid in the filtration of your pond.
- Clean water exits the filter through the outlet and back into your pond.



#### Pressurized Pond Filter

Item# 52360  
UPC: 871980012518

- For ponds up to 900 gallons
- Combines mechanical and biological filtration to clean your pond
- Promotes growth of beneficial bacteria
- Improves water quality
- Can be used in or out of your pond
- Fits 3/4 and 1 in. ID tubing (not included)
- Use with your choice of pond boss® pump between 200-800 GPH (not included)



#### Pressurized Pond Filter with UV

Item# 52387  
UPC: 871980012501

- For ponds up to 1200 gallons
- Combines 9 watt UV clarifier with pressure for maximum cleaning efficiency
- Mechanical and biological filtration cleans your pond
- Promotes growth of beneficial bacteria
- Improves water quality
- Can be used in or out of your pond
- Fits 3/4 and 1 in. ID tubing (not included)
- Use with your choice of pond boss® pump between 400-2300 GPH (not included)
- 16 ft. cord length
- 110/220V/60Hz
- 1 year limited warranty
- ETL listed



UV Bulb should be changed once a season for maximum efficiency.

#### 9W UV Replacement Bulb

Item# 52364  
UPC: 871980012570  
• Replaces 9 watt UV Bulb  
• 8000 hours of life

Integrated 9W UV Clarifier (only in #52387)  
Cleans water with ultraviolet light



Filter Pads should be changed once a season for maximum efficiency.

#### Replacement Filter Pads

Item# 52363  
UPC: 871980012549  
• Contains a coarse and a fine filter  
• Safe for fish and plants



# WATER TREATMENTS

## CHLORINE REMOVER

### KEY FEATURES:

- Removes harmful chemicals from pond water and promotes fish health.
- Ingredients: Deionized water, Sodium Thiosulfate, polymers, and stabilizers.



**Chlorine Remover 32 oz.**  
Item# 54185  
UPC: 871980012013  
Treats up to 3840 gallons

## CHLORINE REMOVER PLUS

### KEY FEATURES:

- Destroys chlorine and chloramines, and it is fortified with natural botanical extracts.
- Ingredients: Water, natural mineral salts, and tea tree and yucca extract.



**Chlorine Remover plus Conditioner 16 oz.**  
Item# 54268  
UPC: 871980013102  
Treats up to 1930 gallons

## SLUDGE REMOVER

### KEY FEATURES:

- Improves filter efficiency, maintains a healthy eco-system, and reduces odors and pond maintenance.
- Ingredients: Deionized water, and selected heterotrophic bacterial strains.



**Sludge Remover 16 oz.**  
Item# 54207  
UPC: 871980011023  
Treats up to 960 gallons



**Sludge Remover 64 oz.**  
Item# 54215  
UPC: 871980011047  
Treats up to 3840 gallons

## WATER CLARIFIER

### KEY FEATURES:

- Quickly clears water and eliminates floating particles and organic matter.
- Ingredients: Deionized water and polymers.



**Water Clarifier 16 oz.**  
Item# 54218  
UPC: 871980011009  
Treats up to 960 gallons



**Water Clarifier 32 oz.**  
Item# 54228  
UPC: 871980011016  
Treats up to 1820 gallons

## FOUNTAIN AND BIRDBATH CLEANER

### KEY FEATURES:

- Keeps fountains, bird baths, and pumps clean by removing limescale buildup.
- Ingredients: Deionized water and natural acids.



**Fountain and Birdbath Cleaner 8 oz.**  
Item# 54187  
UPC: 871980012082  
Treats up to 960 gallons

## BARLEY POND CLARIFIER

### KEY FEATURES:

- Natural solution to pond maintenance.
- Ingredients: Deionized water and natural barley extract.



**Barley Pond Clarifier 16 oz.**  
Item# 54242  
UPC: 871980012969  
Treats up to 2400 gallons

## ALGAECIDE

### KEY FEATURES:

- Stops algae growth.
- Fast acting.



**Algaecide 16 oz.**  
Item# 54104  
UPC: 871980010132  
Treats up to 4730 gallons



**Algaecide 32 oz.**  
Item# 54128  
UPC: 871980010149  
Treats up to 9460 gallons



**Algaecide 64 oz.**  
Item# 54169  
UPC: 871980010156  
Treats up to 18920 gallons

## POND BLUE

### KEY FEATURES:

- Creates beautiful blue water, hides fish from predators, and shades water from harmful UV rays.
- Ingredients: Deionized water and coloring agent.



**Pond Blue 8 oz.**  
Item# 54188  
UPC: 871980011054  
Treats up to 4000 gallons

ALL pond boss® WATER TREATMENTS ARE SAFE FOR FISH, TURTLES, AND PLANTS.



# MAINTENANCE

## POND NET

### KEY FEATURES:

- Durable net
- Great for removing unwanted debris from your pond
- Coated frame protects pond liner & fish
- Telescoping handle (extends 62 in.)



**Skimmer Fish Net**  
Item# 52721  
UPC: 871980005008

- Heavy duty construction
- Lightweight and easy to handle
- Dimensions: 1.12 in. x 14.88 in. x 46.50 in.

# CONSTRUCTION

## PVC POND LINERS

### KEY FEATURES:

- 14.5 mil thickness
- Puncture and UV resistant PVC
- Lightweight, easy to install
- Textured surface promotes the growth of beneficial bacteria
- Reinforced mesh construction
- Highly flexible even in extreme temperatures
- Fish safe
- Color: Black
- 20 year limited warranty



**Pond Skins® Pond Liner**  
**7 ft. x 10 ft.**  
 Item# 52373  
 UPC: 871980012822

**Pond Skins® Pond Liner**  
**10 ft. x 13 ft.**  
 Item# 52736  
 UPC: 871980005503

**Pond Skins® Pond Liner**  
**13 ft. x 20 ft.**  
 Item# 52370  
 UPC: 871980012846

## TUBING

### KEY FEATURES:

- Fish safe
- Color: Black



**Vinyl Tubing**  
**1/2 in. ID x 20 ft. length**  
 Item# 34126  
 UPC: 871980012112

- Fish safe
- Blends in naturally with surroundings
- Color: Black



**Kink Free Corrugated Tubing**  
**3/4 in. ID x 20 ft. length**  
 Item# 34125  
 UPC: 871980012150

- Kink free
- Fish safe
- Blends in naturally with surroundings
- Color: Black



**Kink Free Corrugated Tubing**  
**1 in. ID x 20 ft. length**  
 Item# 34124  
 UPC: 871980012143

- Kink free
- Fish safe
- Blends in naturally with surroundings
- Color: Black



**Kink Free Corrugated Tubing**  
**1 1/2 in. ID x 20 ft. length**  
 Item# 34123  
 UPC: 871980012136

- Kink free
- Fish safe
- Blends in naturally with surroundings
- Color: Black

## POND ACCESSORIES



**Pond and Stone Sealant 12 oz.**  
 Item# 54236  
 UPC: 871980012105

- Expandable black foam
- Fills gaps and ensures efficient water flow over rocks
- Dries in minutes and cures fully in 24 hours



**Pond Skins® Pond Liner Patch**  
 Item# 52375  
 UPC: 871980012228

- Quick and easy way to repair your Pond Skins® PVC or EPDM Pond Liner
- Cures in 12 hours
- 6 in. x 18 in. patch

# WATER FEATURES

## WATERFALL SPILLWAY

### KEY FEATURES:

- Creates a beautiful waterfall or a disappearing water feature.
- Durable, UV resistant, high impact plastic.
- Extended spillway for easy installation.



**8 in. Waterfall Spillway**  
 Item# 52726  
 UPC: 871980005176

- 8 in. spillway
- Fits 3/4 and 1 in. ID tubing (not included)
- Use with your choice of pond boss® pump between 800-2500 GPH (not included)
- Dimensions: 14.4 in. x 10.33 in. x 6 in.

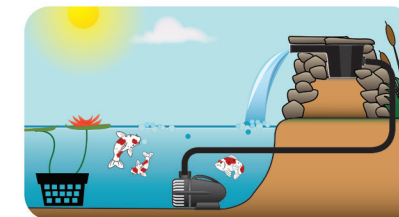

EASILY ADD A WATERFALL TO YOUR POND

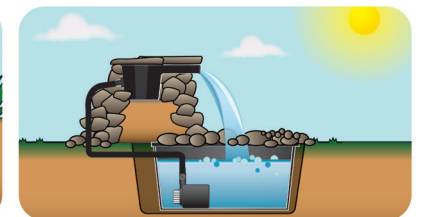

CREATE A DISAPPEARING WATER FEATURE

### EASY INSTALLATION



1. Determine the height of your waterfall
2. Place the spillway based on your measurements
3. Connect the pump and place the pump in the pond
4. Decorate the spillway with rocks

### WHY USE NOZZLES?

- By attaching a nozzle to the outlet of your pump, you are able to control the direction of your flow and introduce oxygen to your water feature.
- It also gives you the option of different decorative water displays.



#### Small Nozzle Kit

Item# 52348  
UPC: 871980012662

- Aerates and decorates ponds, fountains, and containers
- Kit includes:
  - 3 nozzle heads
  - Pump adapter
  - Nozzle adapter
  - Telescoping nozzle extension tube
- Use with your choice of pond boss® pump\* between 75-185 GPH



Waterspray nozzle



Trumpet nozzle insert



Waterbell nozzle insert



Telescoping Nozzle Extension Tube from 5 in. to 9 in.

Nozzle Adapter For the Waterbell and Trumpet nozzle inserts

Adapter

#### Large Nozzle Kit

Item# 52349  
UPC: 871980012655

- Aerates and decorates medium and large ponds
- Kit includes:
  - 4 nozzle heads
  - 2 Nozzle extension tubes
  - Diverter valve
  - Swivel adapter
- Use with your choice of pond boss® pump between 320-800 GPH (not included)



Waterbell nozzle insert



Trumpet nozzle insert



Waterspray nozzle



Foamjet nozzle



Nozzle Adapter For the Waterbell and Trumpet nozzle insert



Adapter for 3/4 in. pump outlets

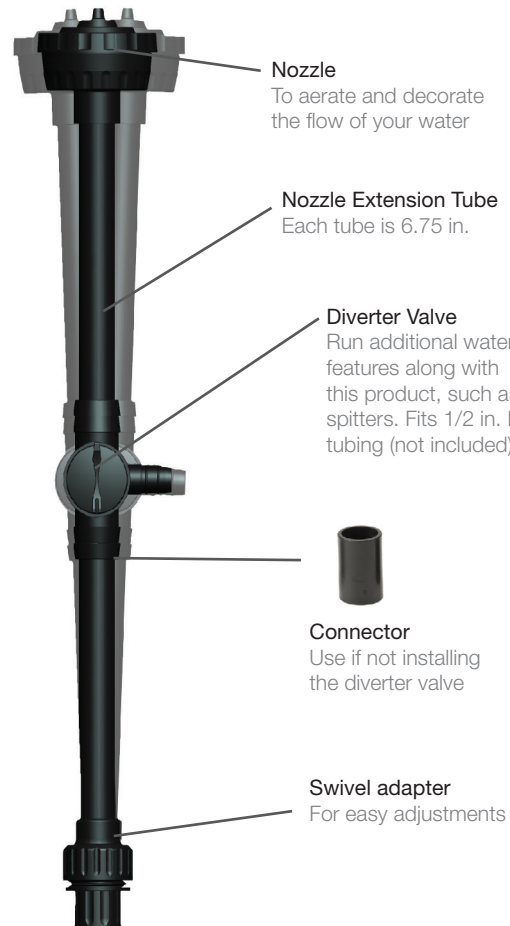

Nozzle To aerate and decorate the flow of your water

Nozzle Extension Tube Each tube is 6.75 in.

Diverter Valve Run additional water features along with this product, such as spitters. Fits 1/2 in. ID tubing (not included)

Connector Use if not installing the diverter valve

Swivel adapter For easy adjustments

#### Complete Nozzle Kit

Item# 52535  
UPC: 871980124617

- Aerates and decorates ponds, fountains, and container
- Combines the Small and the Large Nozzle Kits into one Complete Kit
- Kit includes:
  - 7 Nozzles
  - 2 Nozzle extension tubes
  - Telescoping extension tubes
  - 3 Adapters
  - Connector
  - Diverter valve
  - Swivel adapter
- Small nozzles: Use with your choice of pond boss® pump between 75-185 GPH (not included)
- Large nozzles: Use with your choice of pond boss® pump between 320-800 GPH (not included)



Trumpet nozzle insert



Waterspray nozzle



Waterbell nozzle insert



Telescoping Nozzle Extension Tube from 5 in. to 9 in.

Nozzle Adapter For the Waterbell and Trumpet nozzle inserts

Pump Adapter



Swivel adapter For easy adjustments



Diverter Valve Run additional water features along with this product, such as spitters. Fits 1/2 in., 3/4 in. and 1 in. ID tubing (not included)



Connector Use if not installing the diverter valve



Nozzle Adapter For the Waterbell and Trumpet nozzle inserts



Adapter for 3/4 in. pump outlets



Nozzle Extension Tube Each tube is 6.75 in.



Waterbell nozzle insert



Trumpet nozzle insert



Foamjet nozzle



Waterspray nozzle

### DECOR



#### Floating Lily Pad Variety Pack

Item# 52727  
UPC: 871980005015

- Adds a realistic touch to any pond
- Safe for fish and plants
- Includes 3 lily pads\*
- UV resistant

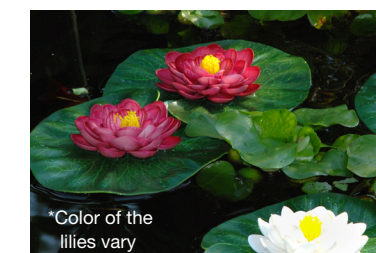

\*Color of the lilies vary



#### Aquatic Plant Basket

Item# 52376  
UPC: 871980012235

- Strong, durable housing for most aquatic plants
- Keeps plants and roots in control
- Will protect plants from fish
- Safe for fish
- Dimensions: 10 in. x 10 in. x 6 in.



# ACCENTS

## LIT CONTAINER FOUNTAIN KIT

### BUILD A CONTAINER FOUNTAIN IN 4 EASY STEPS!

1. If necessary, widen existing hole to approximately 1 1/4 in. diameter.
2. Place the pump inside planter and run cord through newly drilled hole.
3. Use the stopper on the cord to plug the hole, making your container watertight.
4. Fill planter with water. Once pump is fully submerged, plug in, and enjoy!

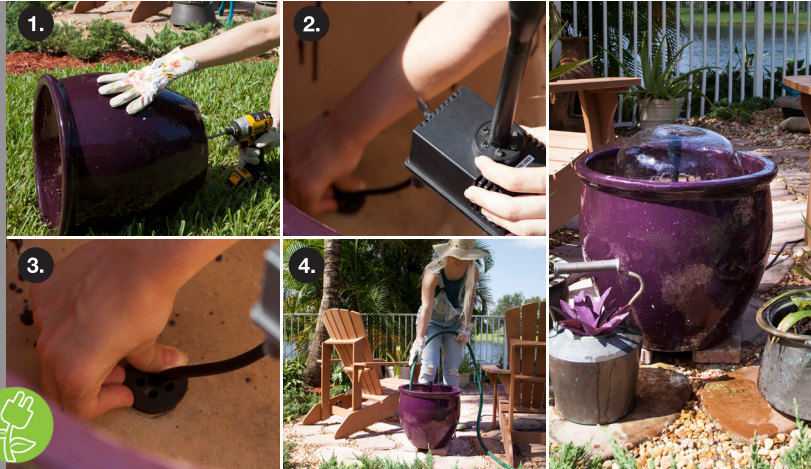

#### Lit Container Fountain Kit

Item# 52709  
UPC: 871980005169

- Easily turn your container into a glowing fountain (container not included)
- For indoor or outdoor use
- Kit includes:
  - 3 nozzle heads
  - 170 GPH pump with 6 ft. power cord
  - Built-in white LED lights
  - Filter box
  - Container stands
  - Telescoping nozzle extension tube
  - Rubber stopper
- 120V 60Hz, 0.12 amps, 8.5 watts
- Dimensions:
  - Pump assembly: 5 in. L x 3.15 in. W
  - Height is adjustable: 11.18 in. min H, 16.42 in. max H



Nozzle Adapter  
For the Waterbell and Trumpet nozzle insert

Waterspray nozzle    Trumpet nozzle insert    Waterbell nozzle insert

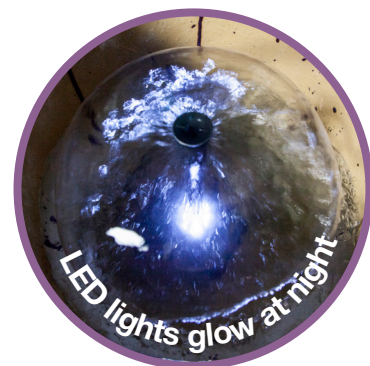

LED lights glow at night

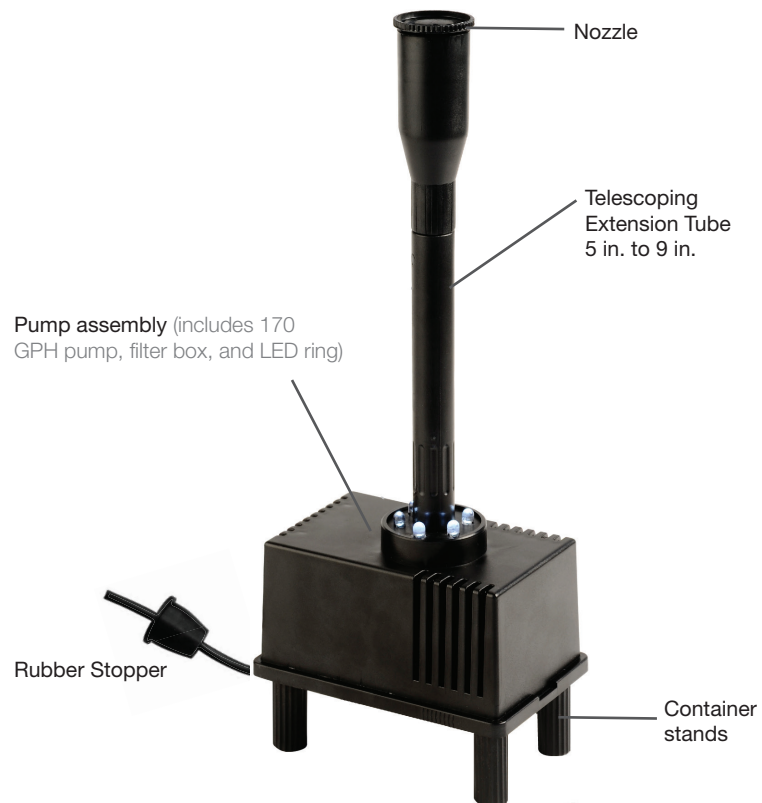

## LIGHTING

### KEY FEATURES:

- For use IN and OUT of water
- Low voltage LED light stays cool
- Automatic dusk to dawn sensor
- UL listed transformer

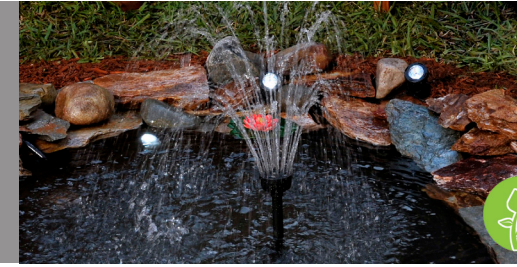

#### Pond & Landscape Light

Item# 52368  
UPC: 871980012594

- Single light
- Weighted base
- Includes 4 color lenses
- 16 ft. cord from transformer to light
- 0.5 watt



#### Pond & Landscape Light Set

Item# 52369  
UPC: 871980012600

- Set of 3 lights
- Weighted bases
- Includes 4 color lenses per light
- 10 ft. cord from transformer to first light, 4 ft. between lights
- 1.5 watt (0.5 per light)



#### Mini Pond & Landscape Light Set

Item# 52774  
UPC: 871980005596

- Set of 6 lights
- 10 ft. cord from transformer to first light, 4 ft. between lights
- 1.2 watt (0.02 per light)

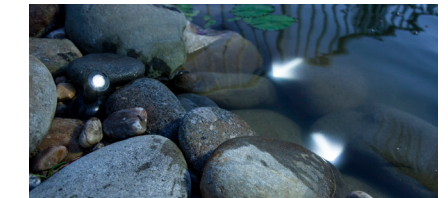

## SPITTERS

### KEY FEATURES:

- Aerates and decorates ponds.
- All Spitters Fit 3/8 in and 1/2 in. ID Tubing (not included).



#### Fish Spitter Blue

Item# 52377  
UPC: 871980012921

- Durable resin, stone finish
- Dimensions: 8.66 x 3.06 x 5.2 in.
- Use your choice of pond boss® pump between 90 GPH-170 GPH (not included)



#### Heron Spitter

Item# 41328  
UPC: 871980012938

- Durable resin
- Dimensions: 5.8 in. x 7.1 in. x 14.2 in.
- Use your choice of pond boss® pump between 90 GPH-170 GPH (not included)



#### Turtle Spitter

Item# 52379  
UPC: 871980012945

- Durable resin
- Dimensions: 9.17in. x 5.24 in. x 4.02 in.
- Use your choice of pond boss® pump between 90 GPH-170 GPH



#### Watering Can Spitter & Planter Silver

Item# 52597  
UPC: 871980004339

- Weather-resistant metal
- Can be used as a planter and a spitter
- Includes two nozzle attachments
- Dimensions: 17.6 in. x 7.5 in. x 8.1 in.
- Use your choice of pond boss® pump between 90 GPH-420 GPH (not included)





61556 / 04-21 ©GeoGlobal Partners, LLC. pond boss is a registered trademark of GeoGlobal Partners, LLC.

**EASY TO USE PRODUCTS, ENDLESS POSSIBILITIES**

Learn more about us at [www.thepondboss.net](http://www.thepondboss.net) or call 1-888-755-6750

