

avivaTM
POWER ON

Portable Power Station

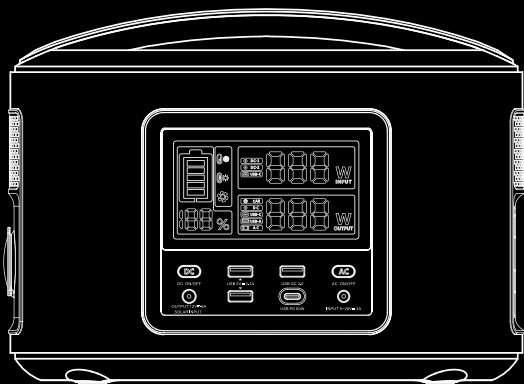

M470
VF-ES002A

USER MANUAL

If in need of service, please contact aviva Customer Service. Do not return this unit to the store.

aviva Customer Service

Email: support@avivapower.com

Visit: www.avivapower.com

Thank you for purchasing an aviva M470 portable power station. The purpose of this manual is to help you understand your product and its use. You can use this product at home and away, wherever life takes you. Many people will use the aviva as a central power source at home, or wherever they need portable power such as off-grid, or for emergency back-up power. **Save this User Manual.**

Long-Term Maintenance:

Fully charge the power station unit prior to long-term storage. Check and charge the power station unit at least once every three months.



WARNING

Keep away from water and fire
Only authorized personnel may service this product

- Specifications
- Product tour & functions
- General information
- How to charge the product
- Connecting devices and using your aviva
- Safety and maintenance
- Warranty statement

SPECIFICATIONS

Battery:

Cell chemistry	Lithium-ion
Energy storage capacity	470 Wh (10.8 V, 43.5 Ah), peak capacity
Single cell equivalent capacity	130,500 mAh @ 3.6 V
Lifecycles	≥500 cycles to 80% with full charge/discharge
Shelf-life	Up to 6 months after full charge; Re-charge once every 3-6 months
Wattage compatibility	300 W continuous, 500 W peak surge
Battery management system (BMS)	Over voltage protection, Low voltage protection, Over temperature protection, Short circuit protection, Over current protection

Input Ports:

DC charging port (5521)	5 V-26 V, 3 A - normally used to recharge via AC adaptor (included)
DC port (6530)	13-20 V, 6 A - normally used to charge optional solar panel + B42
USB-C PD port	One (1) USB-C port, 60 W (5 V/3 A; 9 V/3 A; 12 V/3 A; 15 V/3 A, 20 V/3 A)

Output Ports:

USB ports (4)	One (1) USB-C PD port, 60 W (5 V/3 A; 9 V/3 A; 12 V/3 A; 15 V/3 A, 20 V/3 A) One (1) USB-A port with Quick Charge™ 3.0 Technology (5 V/3 A; 9 V/2 A) Two (2) USB-A ports (Total 5 V, 3.1 A)
---------------	---

DC port (6530)	9-12.6 V, 6 A
Car port	12 V car port (output): 12 V, up to 8 A (120 W max) regulated
110 V AC inverter	Two (2) 110V AC, 60 Hz, 1@ 3-pin, 1@ 2-pin Supports 300 W continuous, 500 W peak surge Pure sine wave

General:

Display panel	4.7" LCD screen clearly displays watt input/output, battery status
Cabinet	Durable aluminum polycarbonate shell
Colour	Light Grey & Black
Weight	5.32 kg (11.72 lb)
Dimensions (LxWxH)	28 x 16 x 21 cm (11.0 x 6.3 x 8.1")
Operating usage temperature	32°-104° F (0°-40° C)
Recharging temperature	41°-95° F (5°-35° C)
AC adapter (included)	110 V/60 Hz; 21 V 3A, 63 W rated, 5.5 mm pin-adapter; includes power cord
Certifications	FCC, RoHS, UN38.3
Warranty	12 months
How to Recharge:	Approximate Recharge Times:
AC wall outlet	8 hrs.
12 V car port	15 hrs.
aviva 100 W solar panel (optional)	8 hrs. with direct sunlight
Optional Accessories:	aviva Portable Solar Panel, 100 W
Included in the Box:	One (1) Power Station

One (1) AC adaptor with power cable

One (1) USB-C cable (1 m/3')

One (1) 12 V car charging cable

One (1) user manual

Included in the Box:

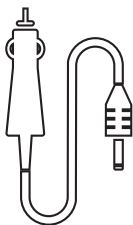

Car cable
charger 12 V

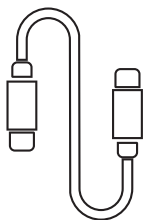

USB-C cable

PRODUCT TOUR & FUNCTIONS

[front view]

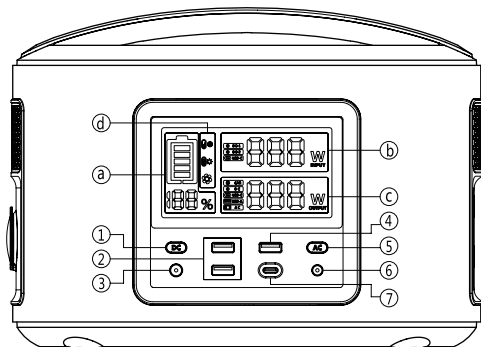

- | | | |
|--------------------------------------|---------------------|---------------------|
| a. Battery level | 1. DC switch button | 5. AC switch button |
| b. Charging power display | 2. USB-A port | 6. DC5521 port |
| c. Discharge power display | 3. DC6530 port | 7. USB-C port |
| d. System temperature status display | 4. QC 3.0 port | |

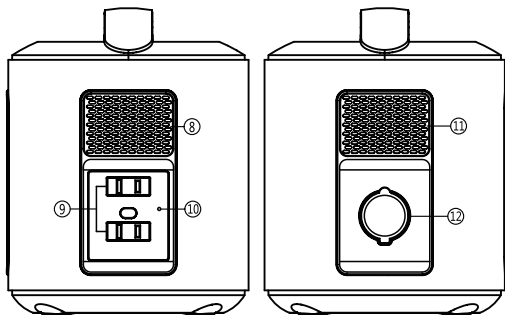

[left view]

[right view]

- | | | |
|-------------------|-------------------------|-------------------------|
| 8. Cooling vents | 10. AC status indicator | 12. Car charger lighter |
| 9. AC output port | 11. Cooling vents | |



Power Tips

1. Power USB outputs > Press either AC or DC button
2. Power off USB > Long-press AC and DC buttons simultaneously
3. Power on/off DC outputs > Long-press DC button
4. Power on/off AC outputs > Long-press AC button
5. Power off all outputs > Press AC and DC button
6. Power off low battery alert > Press either AC or DC button

1. Press the AC and DC power button located on the front of your aviva M470 to activate its power function. Pressing the DC power button will activate the USB ports. When not using the AC or DC ports, make sure to turn the power off to conserve power.
2. The LED light on the button is illuminated when power is on.
3. When power is converted via the inverter, there is some energy lost and you will not experience the full rating of the battery.
4. When you first plug in a power source device, such as a solar panel or a wall charger, the aviva M470 may take a few moments to detect it before it starts drawing power from the source.
5. Cold weather use: Due to the battery's chemical characteristics, cold weather (below zero degrees Celsius) will affect the battery's capacity. If you live in a cold place and cannot use the AC power from the grid, we recommend that you store the unit in a temperature-isolated place.
6. Recycle: Always return used electronics, batteries, and packaging materials to dedicated collection points.
7. Press and hold the DC and AC buttons at the same time to turn off all system outputs and enter the sleep state, thereby saving energy.

Charge Your aviva Now:

Before using or storing, plug your aviva power station into the wall using the included AC adapter until it is fully charged. When charging your aviva you will notice a flashing light on the display screen, indicating that it is charging. Once fully charged, the battery level on the display screen will read 100%. We recommend to charge the unit every 3-6 months.

Charging from the Wall with AC Adapter:

Using the included AC adapter with power cable, plug your aviva into a household wall outlet. When charging your aviva you will notice a flashing light on the display screen, indicating that it is charging. Once fully charged, the battery level on the display screen will read 100%. The aviva M470 should recharge from zero capacity in about 7 hours.

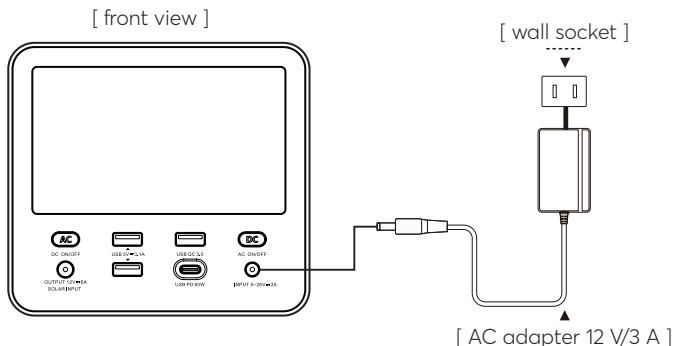

Fast Charging from USB-C Wall Charger:

Plug the included USB-C cable into the 60 W USB-C power delivery port and connect to a compatible third-party USB-C wall charger. Plug your charger into a household wall outlet. When charging your aviva you will notice a flashing light on the display screen, indicating that it is charging. Once fully charged, the battery level on the display screen will read 100%.

[front view]

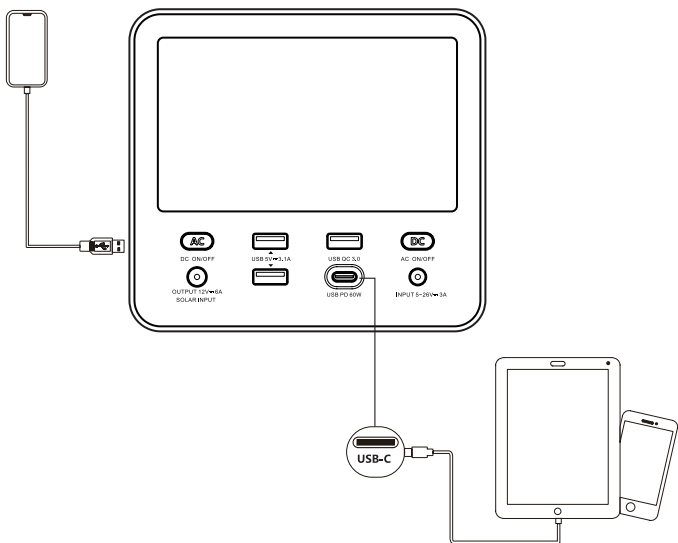

Charging from Solar Panel:

IMPORTANT NOTICE: When solar recharging your aviva M470, pay attention to the voltages of the solar panels and do not exceed 18 V. Exceeding 18 V is not compatible and can cause serious damage to the unit.

The aviva M470 solar charging port is a DC6530 with a 6.5 mm port and is designed to work with compatible solar panels up to 100 W of solar. Solar panels with 18 V typically range in 40 W to 100 W.

1. Position your solar panel where it will get as much direct sunlight as possible.
2. Insert the solar panel plug into the DC6530 port. At the same time, press and hold the DC button for 1 second to activate the DC6530 port. You will know the aviva is charging when the icon is flashing on the display screen. The aviva is fully charged when the battery level on the display screen reads 100%.
3. Some solar panels are chainable to provide more power to your aviva and reduce solar charge times. Note, the maximum solar aviva M470 is capable of taking in is 100 W.

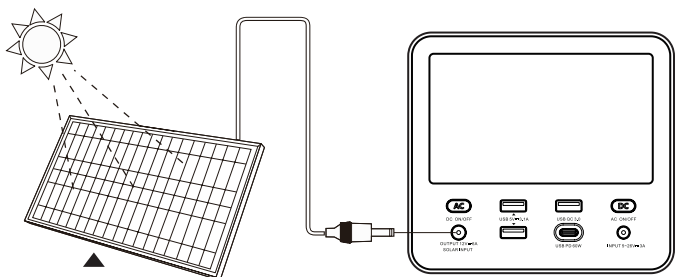

[input]

DC13 V-20 V/8 A

Charging from your Vehicle's 12 V Port:

Using the included cables and adapter, attach the cable to the DC5521 port on the front of aviva M470. Plug into your vehicle's 12 V port (also known as a cigarette lighter port). You will know the aviva is charging when the icon is flashing on the display screen. The aviva is fully charged when the battery level on the display screen reads 100%.

IMPORTANT NOTICE: It is recommended to use this charging method only when the vehicle engine is running.

What you can Power and Charge:

Only devices that are 300 W with a peak of 500 W can be used to power or charge. This includes many small electronics and appliances. To determine how long your device will run or how many charges you can receive from your aviva M470, some math is involved. We recommend an internet search to learn about the relation of energy (Wh) and the consumption of watts (W) by your device.

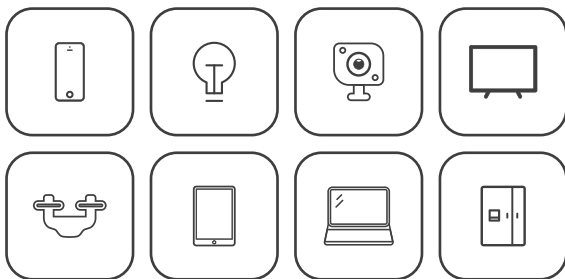

+ more

IMPORTANT NOTICE: Verify your device is suitable for use with the aviva M470. All of the power station output ports have their own max power capacity. Check the Specifications to ensure your device is compatible.

IMPORTANT NOTICE: Press the AC and DC power button located on the front of your aviva M470 to activate its power function. Pressing the DC power button will activate the USB ports. When not using the AC or DC ports, make sure to turn the power off to conserve power.

How to use this Product to Power DC 12 V Devices:

1. Connect the appliance to the DC6530 interface of this product.
2. Press and hold the DC button for 1 second to power the device.
3. Press and hold the DC button for 1 second to turn off the output.

IMPORTANT NOTICE: Make sure the interface of DC 12 V device is a DC6530 male connector, with an outer diameter power plug of 6.5 mm. As per the Specifications, the DC6530 port can take in devices that are <8 A, peak 10 A.

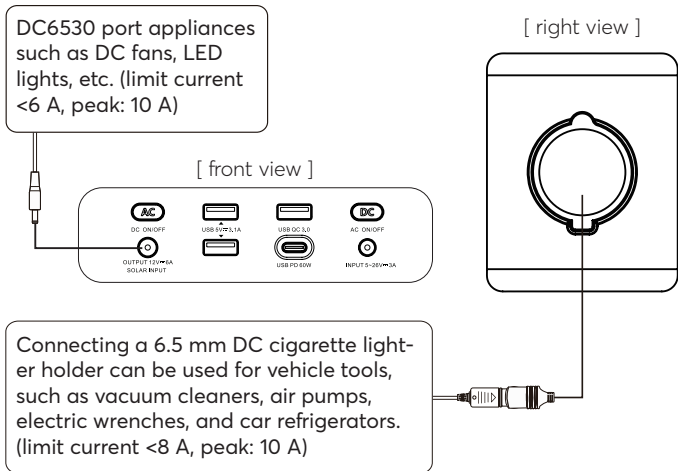

Battery Protection Method:

Short circuit/overpower protection: If the DC output is shorted, the device will shut down for protection. The DC output voltage range of this power station is 9 V – 12.5 V, the rated current is 8A and the maximum output current is 10A. Because batteries are chemicals, the DC output voltage will decrease as the battery capacity decreases. If the DC 12 V device you are connecting does not regulate the charging voltage, the device may shut down or suspend charging due to the low input voltage.

How to use This Product to Power AC Devices:

Connect the plug of the power cord of the device to the AC output of the power station, and then press and hold the AC button for 1 second to activate power to the device. Press and hold the AC button for 1 second to turn off the AC output.

[left view]

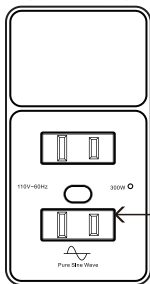

For electrical products with a power of less than 300 W, such as electric lights, televisions, game consoles, etc., turn on the power switch before use.

If the AC output is shorted or the load's electrical power exceeds the AC output power of the product, the power station will trigger a short circuit protection or overpower protection. To eliminate the short circuit, disconnect the attached device, and then restart the power station to restore AC output.

Press and hold the DC and AC buttons at the same time to turn off all system outputs and enter the sleep state, thereby saving energy

Battery Management - Protection Mode:

Short circuit/overpower protection: If the AC output has a short circuit or the output is overpower (i.e. the load is >300 W), the unit will turn off the AC output for protection. Troubleshoot and press the AC output button again to achieve AC output. Some electrical equipment, such as refrigerators, laser printers, etc. may require a peak power to start-up or may occur during its usage. Though the peak power time may be short, this peak power may exceed 500 W or higher, which will result in the unit's overpower protection mode. Such a device is not compatible with the unit. Press the AC button of the unit to reset and activate the AC output.

How to use This Product to Power USB Digital Devices:

Connect the standard USB cable of the digital device to the USB interface of this product, and click the DC button to activate power to the USB ports. The USB of this device will provide power for the digital device. After the device is removed, the product will automatically hibernate after 60 seconds.

[front view]

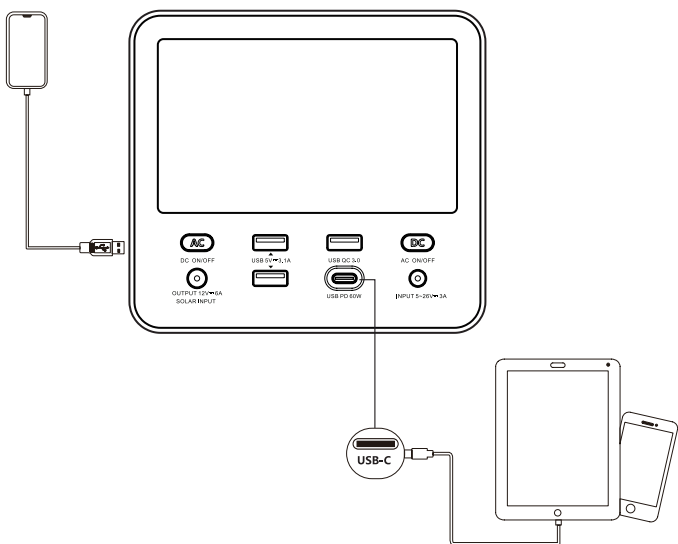

1. This product may become warm to hot during charging, this is normal. Please be careful when handling.
2. Avoid storing this device nearby coins, jewelry, keys, and other metal objects. This has a negative effect on the battery and may cause damage.
3. Do not place the unit near or under intense heat or fire.
4. The unit is not waterproof, avoid water and other liquids.
5. Store the unit in a cool, dry place and avoid humid, dusty environments.
6. Do not disassemble this device without permission.
7. Do not drop, nor place heavy objects on or strongly impact the product.
8. Do not cover this product with objects, such as towels, clothing during use.
9. Do not charge longer than the time required to charge this product.
10. After the device plugged into the unit is fully charged, disconnect it from the aviva M470.

© 2020 All Rights Reserved. GoodWorks Global LLC. All trademarks cited herein are the property of their respective owners. The information contained herein is subject to change without notice. The only warranties for aviva products and services are set forth in the warranty statements accompanying such products and services. aviva shall not be liable for technical or editorial errors or omissions contained

IMPORTANT NOTICE:

1. The pictures in this manual are for reference only. If some pictures do not match the actual product, the actual product shall prevail.
2. The AC power socket and AC voltage and frequency of this product vary from country to country, please refer to the actual product.

First Edition: 1115020.

Document Part Number: CAN UM 11152020.

aviva Power warrants to the original consumer purchaser that the aviva product will be free from defects in workmanship and material under normal consumer use during the applicable warranty period identified in the 'Warranty Period' section below, subject to the exclusions set forth below. This warranty statement sets forth aviva's total and exclusive warranty obligation. We will not assume, nor authorize any person to assume for us, any other liability in connection with the sale of our products.

Warranty Period:

The warranty period is 12 months. In each case, the warranty period is measured starting on the date of purchase by the original consumer purchaser. The sales receipt from the first consumer purchase, or other reasonable documentary proof, is required in order to establish the start date of the warranty period.

Remedy:

aviva will repair or replace (at aviva's option) any aviva product that fails to operate during the applicable warranty period due to defect in workmanship or material. If a valid claim is made during the applicable period, aviva, at its option, will either (1) replace the product, or (2) exchange the product with a product that is of equal value. A replacement product assumes the remaining warranty of the original product or 60 days from the date of replacement, whichever is greater. Customer is responsible for the return shipping costs.

Limited to Original Consumer Buyer:

The warranty on aviva's product is limited to the original consumer purchaser.

Exclusions:

aviva's warranty does not apply to (I) any product that is misused, abused, modified, damaged by accident, or used for anything other than normal consumer use as authorized in aviva's current product literature, or (II) any product purchased through an online auction house. aviva's warranty does not apply to the battery cell unless the battery cell is fully charged by you within seven days after you purchase the product and at least every 6 months thereafter.

How to Receive Service:

To obtain warranty service, you must contact our customer service team via email at support@avivapower.com. If our customer service team determines that further assistance is required, they will give you a Return Material Authorization ("RMA") number and will provide you with return instructions. You must properly package the product, clearly marking the RMA number on the package and including proof of your purchase date with the product. We will process your return and send your repaired or replacement product to you in North America. For product purchased or being shipped outside of North America, please contact the local distributor from whom you purchased the product or email support@avivapower.com to obtain further information.

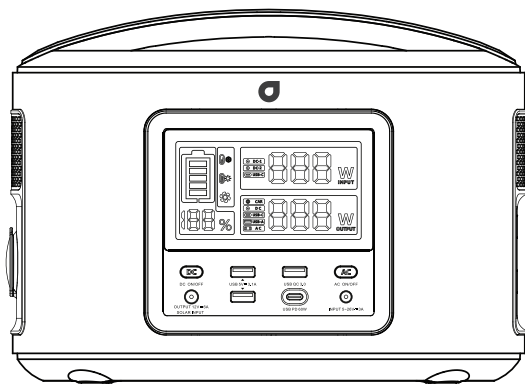

EXCLUSIVE REMEDY; LIMITATION OF LIABILITY:

The foregoing provisions state aviva's entire liability, and your exclusive remedy, for any breach of warranty, express or implied. IN NO EVENT WILL AVIVA BE LIABLE FOR ANY CONSEQUENTIAL OR INCIDENTAL DAMAGES ARISING FROM ANY USE OR MALFUNCTION OF ANY AVIVA PRODUCT, OR FROM ANY BREACH OF WARRANTY, INCLUDING DAMAGE TO OTHER DEVICES. IN NO EVENT WILL AVIVA'S LIABILITY FOR ANY CLAIM, WHETHER IN CONTRACT, WARRANTY, TORT (INCLUDING NEGLIGENCE AND STRICT LIABILITY) OR UNDER ANY OTHER THEORY OF LIABILITY, EXCEED THE AMOUNT PAID BY YOU FOR THE AVIVA PRODUCT. Some states do not allow the exclusion or limitation of incidental or consequential damages, so the above limitation or exclusion may not apply to you.



www.avivapower.com

CAN UM 11152020