

Care Instructions

Eos Café Table

Eos Café Table – designed by Matthew Hilton

To prolong the life of the product and retain its appearance and functionality, we would like to give you some relevant information and care advice:

Made from aluminium, the Eos outdoor range is durable, lightweight, rustproof and low maintenance. Regular periodic care and cleaning is recommended over occasional heavy-duty maintenance.

The table frame and slats are finished in a hardwearing powder coat which can be cleaned using a sponge / soft bristle brush with a cleaning solution of mild liquid soap and lukewarm water. The use of abrasive cleaners should be avoided.

Rinse and dry thoroughly for best finish.

Caution: In seaside use, salt can accumulate on the finish which may lead to surface damage.

In indoor pool areas, chlorides can accumulate on the finish which may lead to surface damage.

In both of the above environments, repeated cycles of condensation followed by evaporation will cause build-up of these aggressive corrosives. Regular cleaning with mild soap and water will remove the concentrated deposits and protect the furniture finish per the above instructions.

Although the materials and finished used are selected for their 'all weather / year-round' characteristics, we recommend that the product is disassembled and stored during cold and wet winter months.

If stored fully assembled the table should not be stored upside down.

We thank you for purchasing this product and wish you many years of enjoyable and functional use.

For more related products please visit: casefurniture.com



case





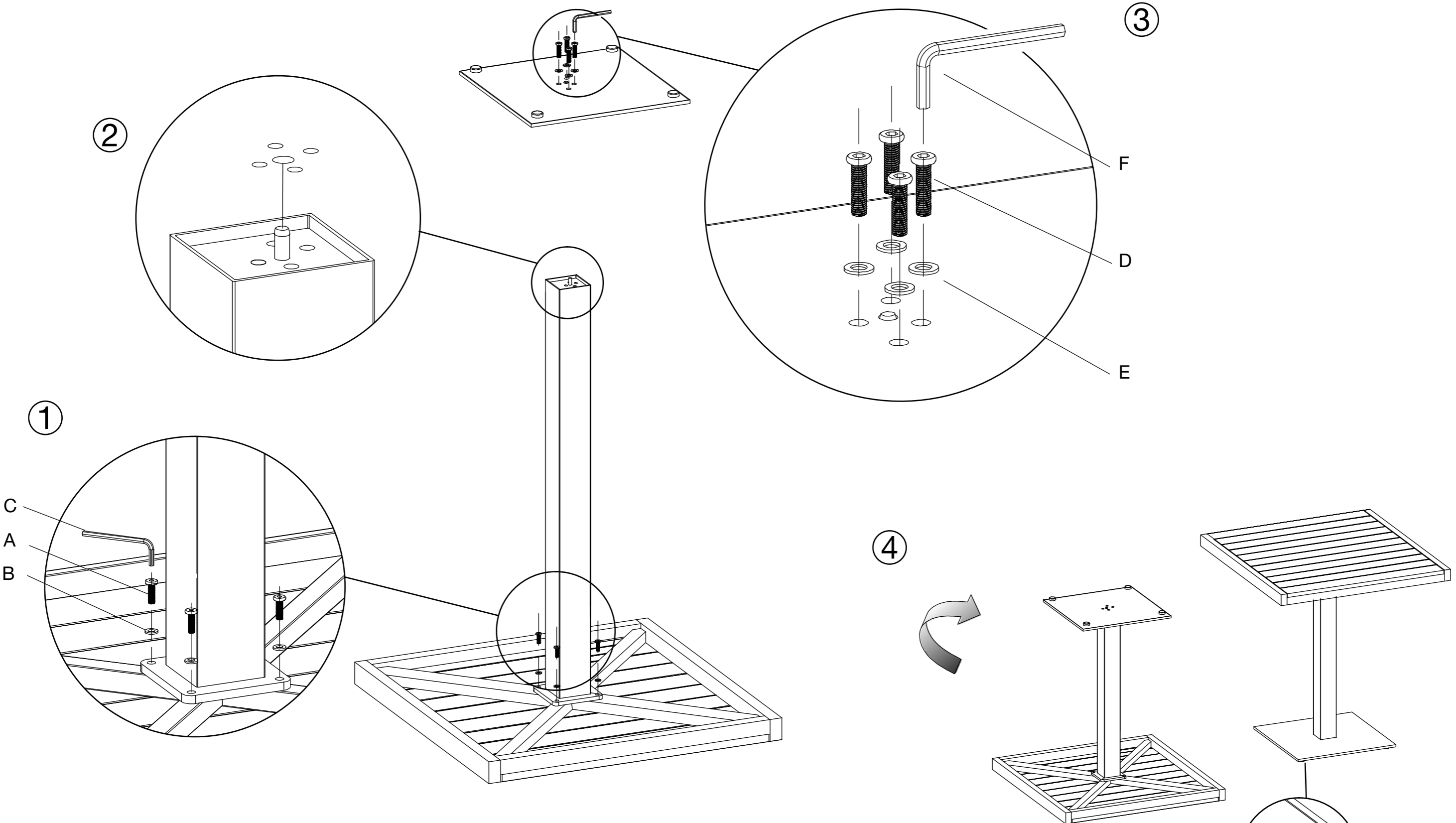

Case Furniture Ltd
London, SW18 2HZ
United Kingdom
info@casefurniture.com
casefurniture.com

case

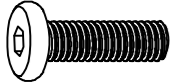
Assembly Instructions

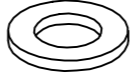

Provided

					
A x 4	B x 4	C x 1	D x 4	E x 4	F x 1

