

spacevector™

SFV1000

INSTALLATION, PROGRAMMING & SERVICE MANUAL

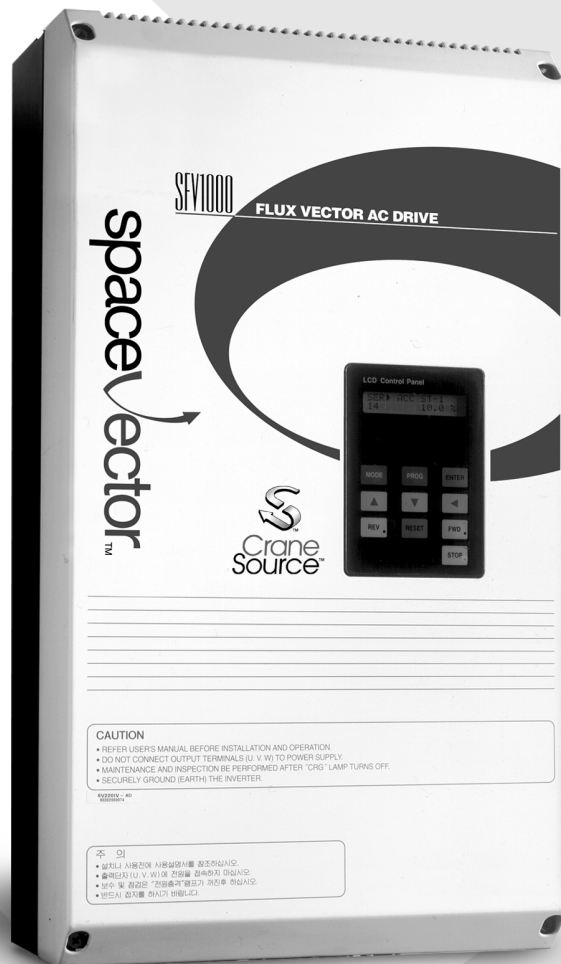

Crane
Source™

COLUMBUS MCKINNON CORPORATION

Version 2

SFV1000

Table Of Contents

Introduction	4
Section 1: Installation	
Step 1: Inspection of Drive	6-13
Step 2: Mounting the Drive	14-17
Step 3: Wiring the Drive	18-29
Section 2: Start Up Programming	
Step 1: Keypad Layout	29-30
Step 2: Keypad Operation	
Definitions	31
Moving Through Each Group Level	32
View a Specific Function [Code No.] Using Jump Code Location	33
Viewing all Function [Code No's] Within a Group Level	34
Function Code List	35-39
Step 3: Auto Tuning	40-42
Step 4: Initial Setup Programming	
Programming the Drive for a Specific Application	43-45
Programming the Speed Selection	46-49
Drive Operation Checks	50
Section 3: Programming	
Passwords and Group Access Levels	52
Entering a Password	53
Back Door	54
Changing a Password	55
Programming Function Data	56
Section 4: Trouble Shooting	
Fault Trip Descriptions and Reasons for Faults	58
Monitoring Fault Trips	59-60
Trouble Shooting Flowcharts	61-66
Trouble Shooting Procedures	67-72
Pushbutton Pendant Test	73
Multi-function and Analog Output Test	74
Section 5: Features	75-85
Section 6: Detail In/Out and Function Code Descriptions	
Multi-function Contact Inputs	86-89
Multi-function Contact Outputs	90
Function Code Description	91-104

SpaceVector™ Variable Frequency Drives

Congratulations on the purchase of a SpaceVector™ SFV1000 Series drive. This is the most advanced drive on the market today specifically designed and programmed for the overhead material handling industry by the leader in the industry, Columbus McKinnon Corporation.

SpaceVector™ drives have many advantages and features to meet the very specific and demanding needs of the crane and hoist industry. Features such as:

- Most efficient energy utilization of any drive on the market resulting in less motor heat.
- Cooler running motors last longer saving on downtime and maintenance costs.
- Efficient utilization produces more torque resulting in better load control.
- Reduced motor harmonics improving motor performance and lengthening life.
- Easy Macro Quick Set Programming for faster start-up and servicing.
- Plain English programming and service manual saves time.

IMPORTANT! PLEASE READ!

Before proceeding any further, please read the following important information regarding the drive and its proper handling and use:

- **Please read this manual completely before working with the drive.**
- **The drive operates on and contains high voltage that can cause electric shock resulting in personal injury or loss of life. Handle the drive with the same care and caution as all other high voltage electrical components.**
- **Be sure to disconnect all AC input power to the drive before servicing. Lock and tag the main switch in the de-energized position per ANSI Z 244.1**
- **Wait at least 3 minutes after disconnecting the AC input power to the drive. If the bus capacitor discharge circuit fails, high voltage can remain in the drive for a period of time after the AC power is disconnected.**
- **Do not perform high voltage tests such as Megger testing.**
- **Only qualified personnel should perform service.**
- **Insure unit is properly grounded.**
- **Disconnect drive before performing any welding on the bridge crane structure. Do not weld the hook to the hook or to a load suspended from the hook.**



WARNING

- **Never turn off the power of the drive unless load is on the ground.**

On the following pages are specification and selection tables for the drives and dynamic braking resistors. Please check to insure you have the proper equipment for your application.

Section 1: Installation

Step 1: Inspection of Drive

Step 2: Mounting the Drive

Step 3: Wiring the Drive

Step 1: Inspection of Drive

- Inspect the drive for any physical damage that may have occurred during its shipment. If any parts of the drive are missing or damaged, contact your SpaceVector™ distributor immediately.
- Verify the nameplate of the SFV1000 drive. Verify that the drive part number matches your order and packing slip.
- Verify that the Dynamic Braking Resistor part number matches your order and packing slip.
- If there are questions, reference Tables 1.1, 1.2, 1.3, 1.4 and 1.5 for Drive and Resistor specifications.

 WARNING
WORKING IN OR NEAR EXPOSED ENERGIZED ELECTRICAL EQUIPMENT PRESENTS THE DANGER OF ELECTRIC SHOCK.
TO AVOID INJURY: <ul style="list-style-type: none">• Disconnect and lockout power to the drive per ANSI Z 244.1• Wait 3 minutes after disconnecting power for capacitor to discharge before entering drive.

Table 1.1 - SFV1000 Drive Common Specifications

Item	Specification	
Control	Topology	SpaceVector PWM using IGBT
	Controller	Field oriented control, Speed controller with minor current controller
	Speed control accuracy	- 0.2% (analog), - 0.01% (digital) of maximum speed
	Speed setting resolution	- 0.005% of maximum speed
	Cutoff frequency of ASR	50 Hz
	Range of torque control	1:50
	Torque control accuracy	- 5%
	Acceleration/Deceleration	0 ~ 3600 sec, 2 sets of acceleration and deceleration time available, linear / s curve
	Braking	Dynamic braking with external resistor (150% of rated torque) 2.2 ~ 7.5 kW : DB circuit is included
Protection	Overcurrent, Overvoltage, Low voltage, Inverter overheat, Inverter NTC failure, Motor overheat, Motor NTC failure, Over speed, External trip, Fuse open, Ground Fault Protection	
Input	Speed setting	Terminal V1, V2 (0 ~ -10V, polarity available), Terminal / (4~20mA)
	Analog input 2	Terminal V1, V2 (0 ~ -10V) is defined by user among 7 functions (*1)
	Contact inputs	FX (forward/up run), RX (reverse/down run), BX (emergency stop), RST (reset) 7 multi-function inputs (P1~P7) are defined by user among 17 functions (*2)
Output	Analog output 1 - Analog output 2	Two (2) analog outputs are defined by user among 13 data selections (*3)
	Fault relay	A (normal open), B (normal close) C (common)
	Auxiliary relay 1, 2	[A1, 1B], [2A, 2B] (normal open) are defined by user among 11 functions (*4)
	Open collector 1, 2, 3	OC1, OC2, OC3 are defined by user among 11 functions (*4)
Operating Condition	Altitude	Less than 1000m without derating
	Temperature and humidity	-10 C ~ 40 C, 90% relative humidity, noncondensing
	Cooling	Forced air cooling
	Class of enclosure	[2.2 ~ 7.5kW] IP52, [11 ~ 22kW] IP20

*1 Speed reference value, Torque reference value, Flux reference value, Torque bias value, Torque limit value, Outer PI Controller reference Input, Outer PI Controller feedback.

*2 Multi-speed select , Multi-accel./decel. time select, Soft start cancel, ASR PI gain select, ASR P/PI select, Flux reference select, Pre-excitation External trip input (Normally Closed), Speed/ Torque control select, Torque limit ON, Torque bias ON, Forward-run prohibit, Reverse-run prohibit, 3-Wire Operation, External trip input (Normally Opened).

*3 Motor speed (no polarity), Motor speed (polarity available), Speed reference 1, Speed reference 2, Torque reference 1, Torque reference 2, Torque reference 2 (polarity available), Torque current, Flux reference Magnetizing current, Inverter output current, Inverter output voltage, Motor temperature, DC link voltage.

*4 Zero speed detection, Speed detection (polarity available), Speed detection (polarity ignored), Speed arrival, Speed deviation, Torque detection, Torque limiting, Motor overheat warning, Inverter overheat warning, Low voltage warning, Inverter running.

Table 1.2 - SFV1000 Drive Specifications According to the Capacity for 230Volts

SpaceVector™ Drive Specifications (230 V)											
Drive 446485		-30	-31	-32	-33	-34	-35	-36	-37	-38	-39
Output Ratings	Capacity [kVA]	4.2	6.1	9.1	12.2	17.5	24.3	30.5	36.2	46	55
	Continuous rated [FLA]	11	16	24	32	46	59	74	87	122	146
	Ref HP	3	5	7.5	10	15	20	25	30	40	50
Input Ratings	Input voltage	200 ~ 230V									
	Input voltage	+ 10% ~ -15% (Below 200V, output power is too low)									
	Input frequency	60 Hz (– 5%)									
Control	Overload Capacity	150%, 1 minute									

Table 1.3 - SFV1000 Drive Specifications According to the Capacity for 460Volts

SpaceVector™ Drive Specifications (460 V)															
--	--	--	--	--	--	--	--	--	--	--	--	--	--	--	--

Drive 446485		-50	-51	-52	-53	-54	-55	-56	-57	-58	-59	-60	-61	-62	-63	-64
Output Ratings	Continuous rated (FLA)	5.5	8	12	16	24	30	39	45	61	75	91	110	152	183	223
	Ref HP	3	5	7.5	10	15	20	25	30	40	50	60	75	100	125	150
Input Ratings	Input voltage	400 ~ 460V														
	Input voltage	+ 10% ~ -15% (Below 400V, output power is too low)														
	Input frequency	60 Hz (– 5%)														
Control	Overload Capacity	150%, 1 minute														

Table 1.4 - Braking Resistor Guide

Input Voltage	Applied Motor	Inverter Identification	Recommended Braking Resistor - for Hoists without Mechanical Load Brake		
			Watts	Ohms	Resistor Part Number
230V	2.2kW (3 hp)	446485-30	1200	60	446485-A8
	3.7kW (5 hp)	446485-31	2400	30	446485-B3
	5.5kW (7.5 hp)	446485-32	3600	20	446485-B6
	7.5kW (10 hp)	446485-33	4800	16	446485-C0
	11kW (15 hp)	446485-34	7200	10	446485-C3
	15kW (20 hp)	446485-35			
	18.5kW (25 hp)	446485-36	10800	7	446485-C4
	22kW (30 hp)	446485-37			
	30kW (40 hp)	446485-38			
	37kW (50 hp)	446485-39			
460V	2.2kW (3 hp)	446485-50	1600	200	446485-B0
	3.7kW (5 hp)	446485-51	2400	120	446485-B2
	5.5kW (7.5 hp)	446485-52	4000	80	446485-B8
	7.5kW (10 hp)	446485-53	4800	60	446485-B9
	11kW (15 hp)	446485-54	7200	40	446485-C1
	15kW (20 hp)	446485-55	7200	30	446485-C2
	18.5kW (25 hp)	446485-56	14400	20	446485-C6
	22kW (30 hp)	446485-57			
	30kW (40 hp)	446485-58	14400	16	446485-C7
	37kW (50 hp)	446485-59	14400	13	446485-C8
	45kW (60 hp)	446485-60	20000	7.7	
	56kW (75 hp)	446485-61	24000	6.3	
	75kW (100 hp)	446485-62	30000	5.0	
	94kW (125 hp)	446485-63	45000	5.35	
	112kW (150 hp)	446485-64	55000	4.38	

Table 1.5 - Resistor Unit Specifications

Terminal	Connection	Terminal State
B1, B2	Inverter main power terminal circuit P, R	
P7, CM	Connect the Inverter control terminal P7, CM and select the multi-function input of P7 to Normally Closed External trip (10) to detect the overheating of the resistor unit	Normally ON until the resistor is overheated, then P7 input becomes open

Step 2: Mounting the Drive

Environmental Conditions

- Verify the ambient condition of the drive mounting location. The ambient temperature range should be 14 to 104°F (-10 to 40°C).
- The relative humidity should be less than 90% (non-condensing), below the altitude of 3280 ft. or 1000m.
- Do not mount the drive in direct sunlight.
- The drive should be isolated from excessive vibration.
- The drive should be protected from moisture, dust, metallic particles, corrosive gases and liquids.

Mounting

- The SFV1000 must be mounted vertically with sufficient space (horizontally and vertically) between adjacent equipment to permit proper heat dissipation. See Figure 1 below. See pages 13 - for actual drive dimensions and Table 1.6 for drive enclosure size.

Fig. 1 - Recommended Clearances for Drive Mounting

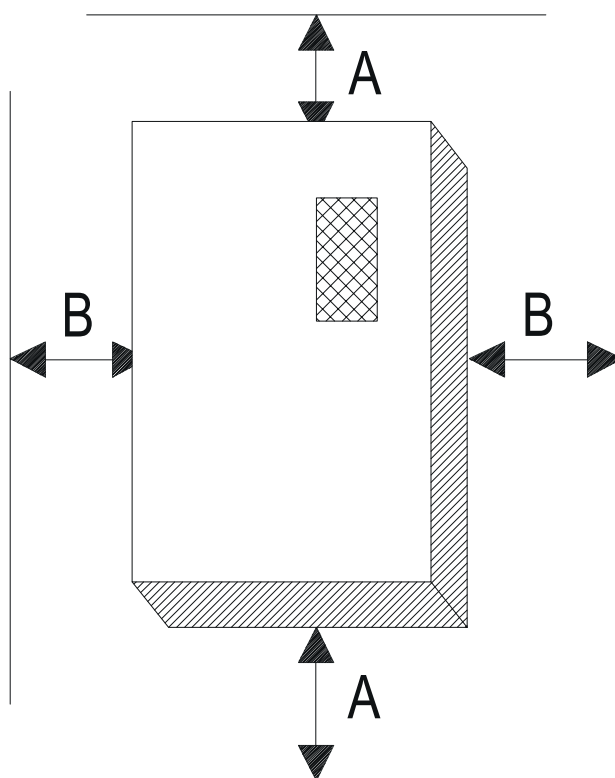

A: over 6.0" (15cm)

B: over 2.0" (5cm)

Table 1.6 - SFV1000 Drive Enclosure Sizes

Drive Part Number	Size	NEMA Rating
446485-30	1	NEMA 1
446485-31		
446485-32	2	
446485-33		
446485-50		
446485-51		
446485-52		
446485-53		
446485-34	3	
446485-35		
446485-54		
446485-55	4	
446485-36		
446485-37		
446485-56		
446485-57	5	
446485-58		
446485-38	6	
446485-39		
446485-59	7	
446485-60		
446485-61		
446485-62	8	

Size 1 SFV1000 Drive Dimensions

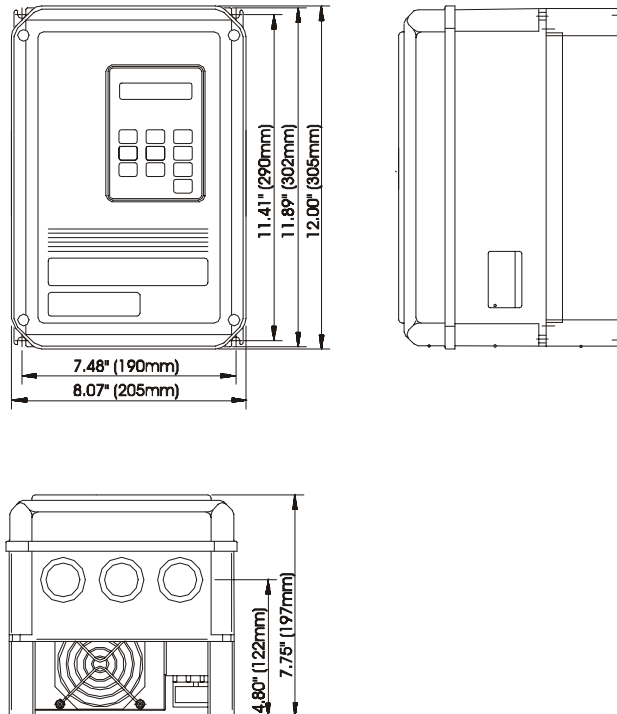

Size 2 SFV1000 Drive Dimensions

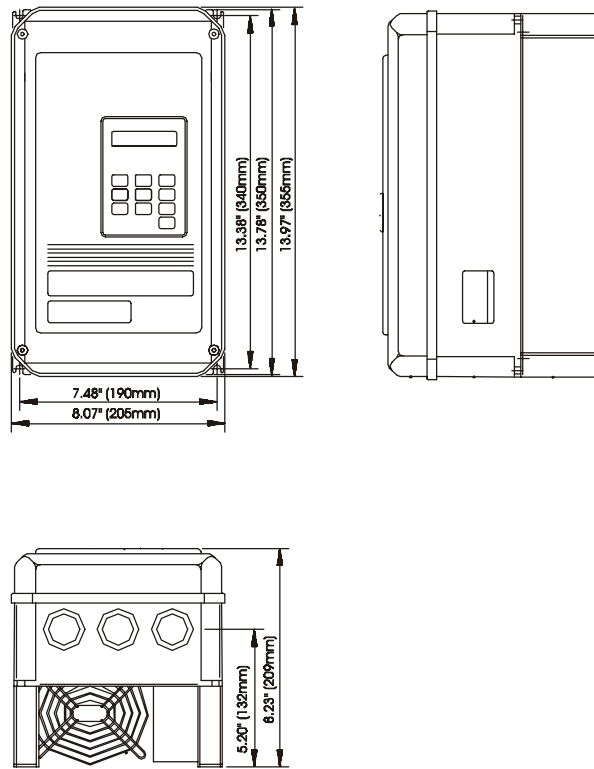

Size 3 SFV1000 Drive Dimensions

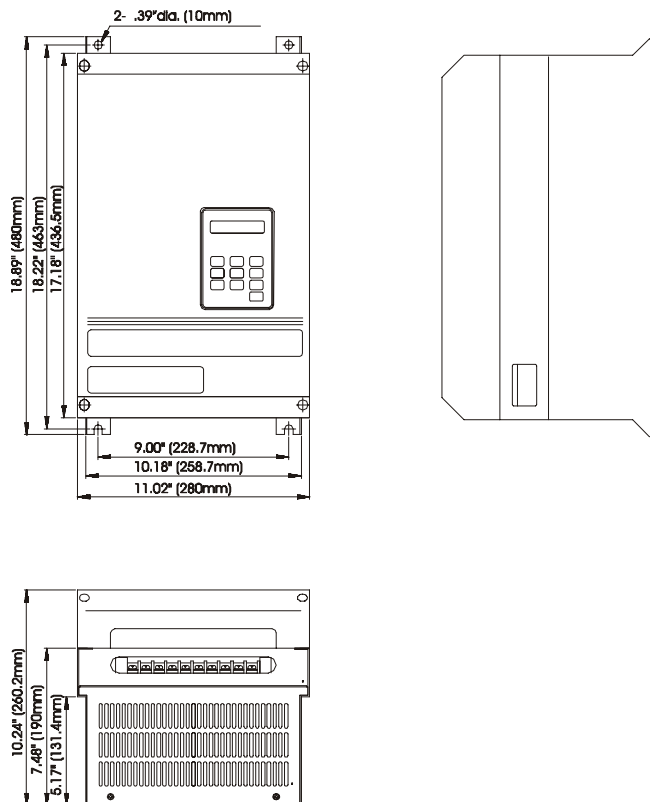

Size 4 SFV1000 Drive Dimensions

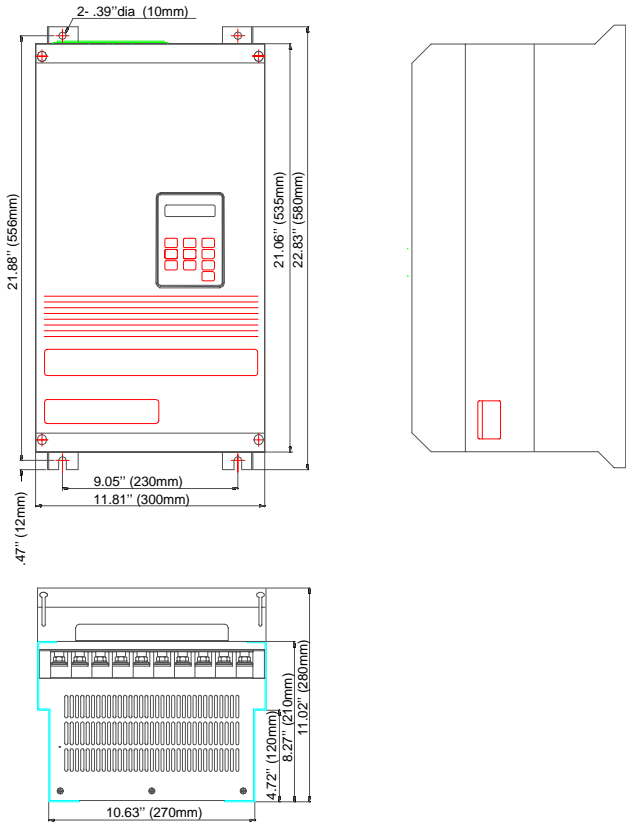

Size 5 SFV1000 Drive Dimensions - 40hp @ 460V

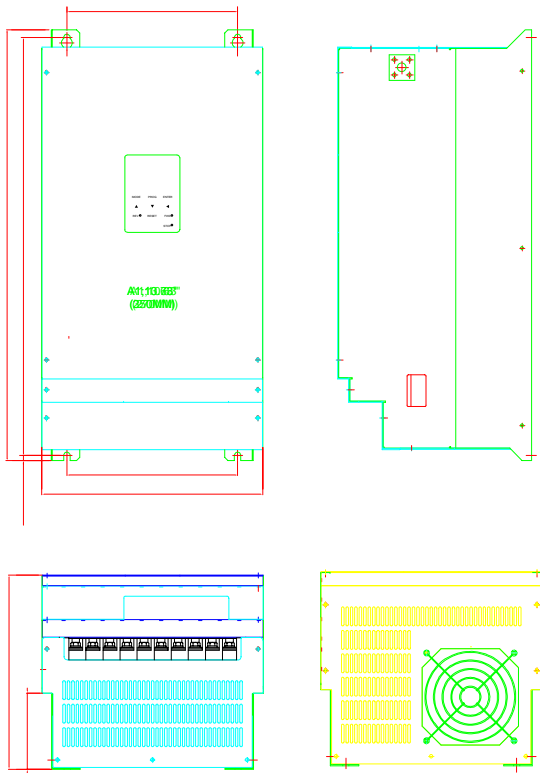

Size 6 SFV1000 Drive Dimensions - 40 & 50hp @ 230V

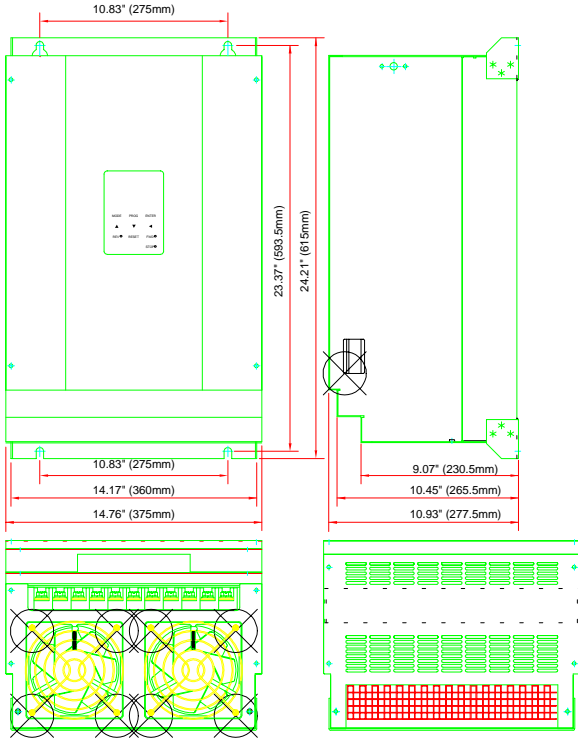

Size 7 SFV1000 Drive Dimensions - 50, 60 & 75hp @ 460V

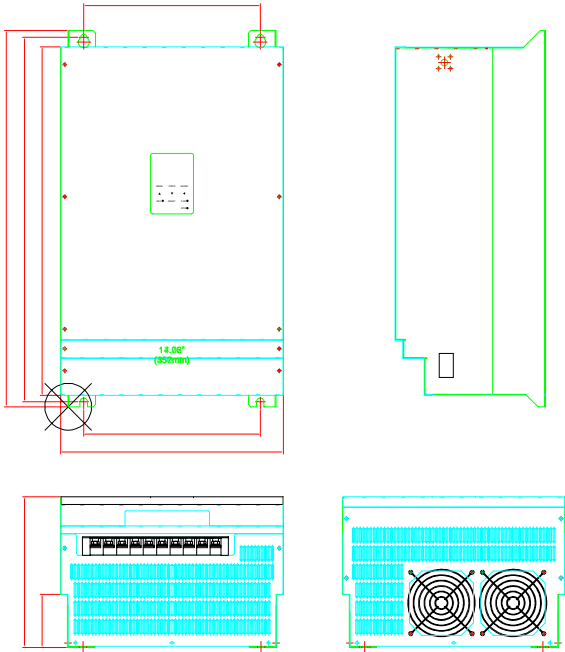

Size 8 SFV1000 Drive Dimensions - 100hp @ 460V

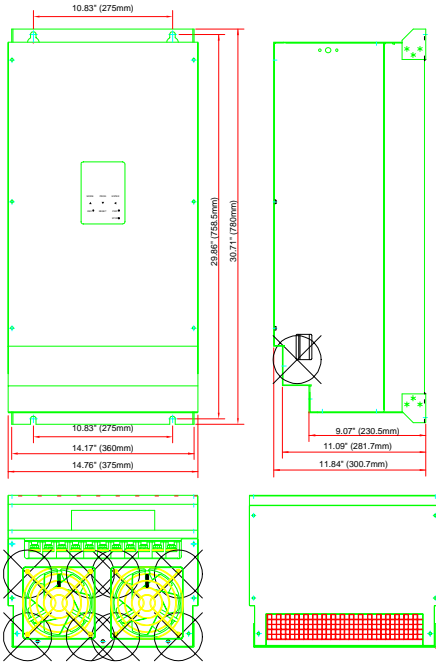

Size 9 SFV1000 Drive Dimensions - 125 & 150hp @ 460V

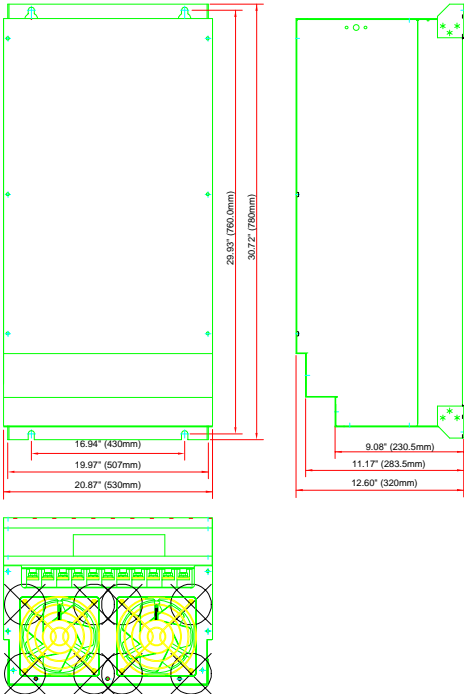

Step 3: Wiring the Drive

Remove Cover From Drive

Figure 2 below is a reference for the basic Input / Output Terminals of a SFV1000 drive.

Fig. 2 – Basic wiring diagram for the SFV1000 drive.

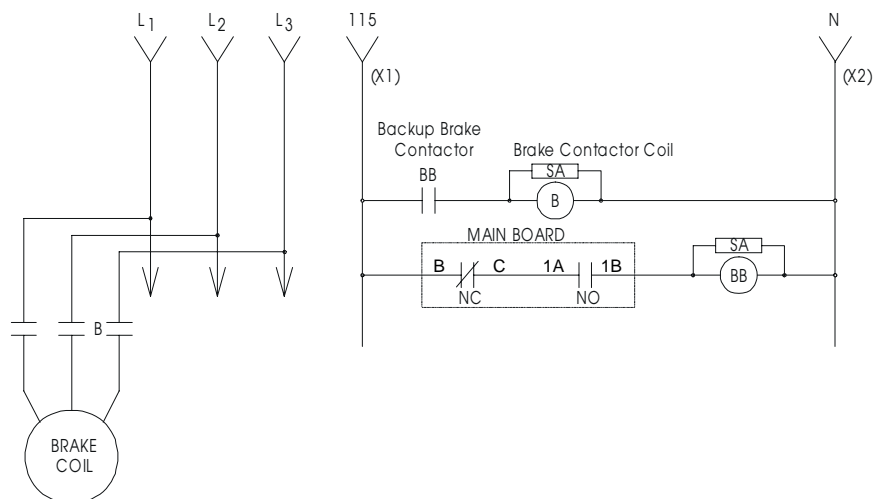
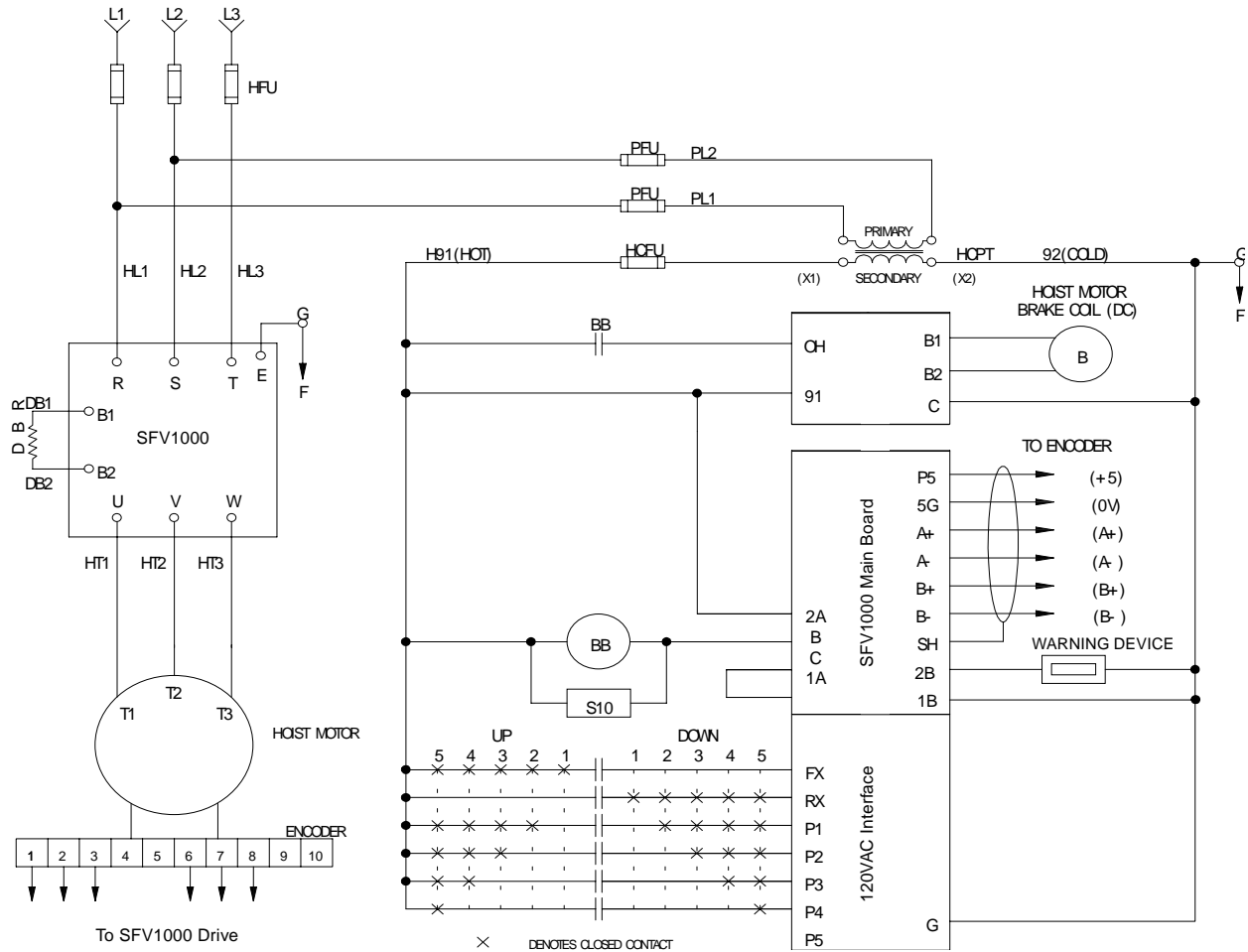

Check For Correct Wire Gauges

Insure the correct wire gauges for the input and output power leads are being used before wiring the drive. Use Table 1.7 for reference.

Table 1.7 – Wire Gauge Reference Table.

SFV1000 Drive Class	Drive Rated Amp.	Input AWG	Output AWG	Ground AWG	DB Resistor AWG	Control AWG	
230V Class	11.0	12	12	12	12	16	
	16.0			10			10
	24.0	6	6		8		
	32.0			4			4
	46.0	12	12		12		
	59.0			10			10
	74.0	8	8		8		
	87.0			6			6
460V Class	6.0	12	12		12	12	
	8.0			10			10
	12.0				8		
	16.0			6			6
	24.0						
	30.0						
	39.0						
	45.0						
	61.0						
	75.0						
	91						
	110						
	152						
	183						
223							

Fuse and Circuit Breaker Selection

Reference Table 1.8 to properly apply fuses and circuit breakers to the drive.

Table 1.8 – Fuse and Circuit Breaker Selection

SFV1000 Drive Voltage	Ref. HP	SFV1000 Part Number	Fuse Rating Class (J)	Molded Case Circuit Breaker
230V	3	446485-30	20A	25A
	5	446485-31	25A	30A
	7.5	446485-32	35A	50A
	10	446485-33	40A	60A
	15	446485-34	50A	75A
	20	446485-35	80A	100A
	25	446485-36		125A
	30	446485-37	100A	150A
460V	3	446485-50	10A	15A
	5	446485-51	15A	20A
	7.5	446485-52	20A	25A
	10	446485-53	25A	30A
	15	446485-54	35A	40A
	20	446485-55	40A	50A
	25	446485-56	50A	60A
	30	446485-57	65A	75A
	40	446485-58	70A	125A
	50	446485-59	80A	
	60			
	75			
	100			
	125			
	150			

Wiring The Power Leads

Use Figure 3 as shown below to assist in wiring the power leads to the drive.

Fig. 3 – Input / Output Power and Dynamic Braking Resistor Wiring Diagram.

Arrangement of Power Terminal Strip

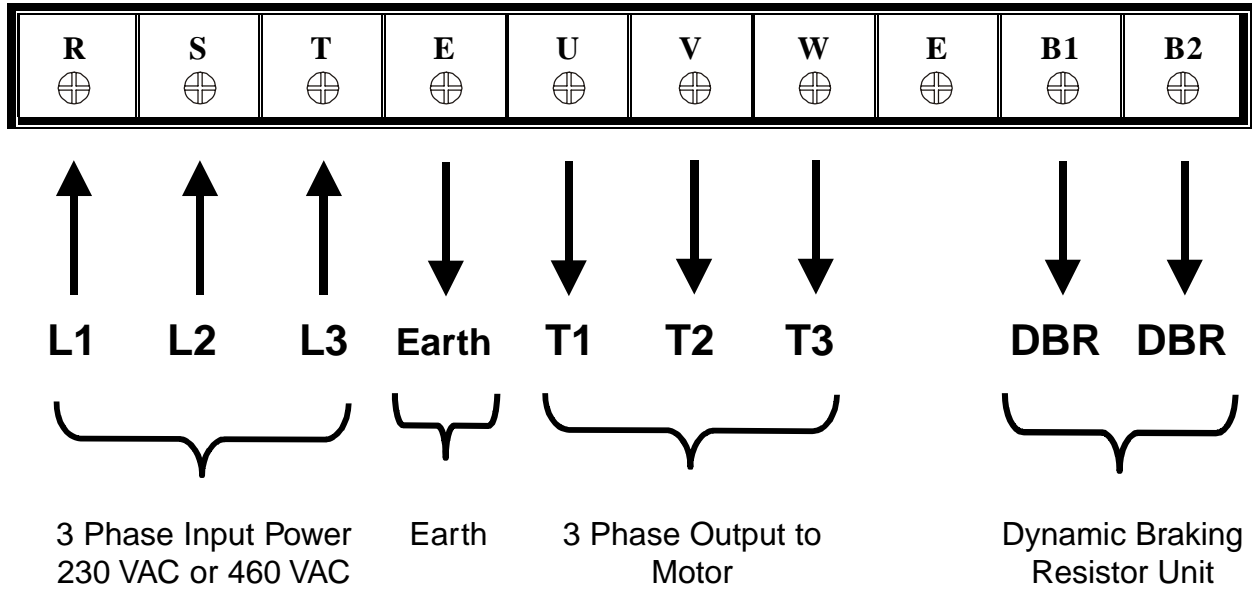

Note: Slotted tongue terminals are recommended for connections shown in Figure 7.

Terminal	Symbol	Description
Main Power Terminal	R, S, T	3 Phase Input Power Terminals
	U, V, W	3 Phase Output Terminals
	B1, B2	External Dynamic Braking Resistor Terminals
	E	Ground Terminals

Wiring The Dynamic Braking Resistor Leads

Use Figure 4 as shown below to assist in wiring the Dynamic Braking Resistor leads to the drive.

Fig. 4 – Input / Output Power and Dynamic Braking Resistor Wiring Diagram.

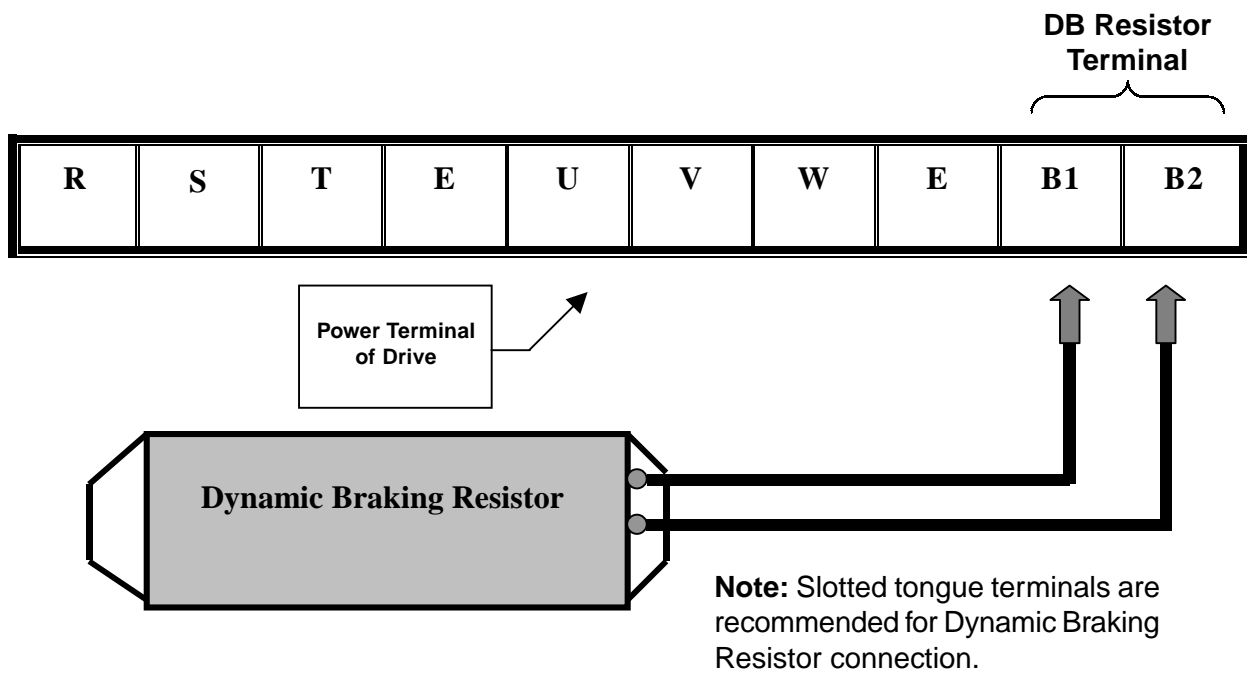

- The **Dynamic Braking Resistors** dissipate the motor rotational energy in the form of heat. They are required for all hoisting and traverse applications.
- If the dynamic braking resistor has a bad connection or is missing, the drive DC Bus voltage may increase, resulting in an over voltage fault.

120 VAC Interface Card Connection:

The SFV1000 SpaceVector™ Drive comes equipped with the 120VAC Interface Card installed. Figure 5 below shows the connection of the interface card to the control terminal strip.

Fig. 5 - Interface Card Connection to the Control Terminal Strip

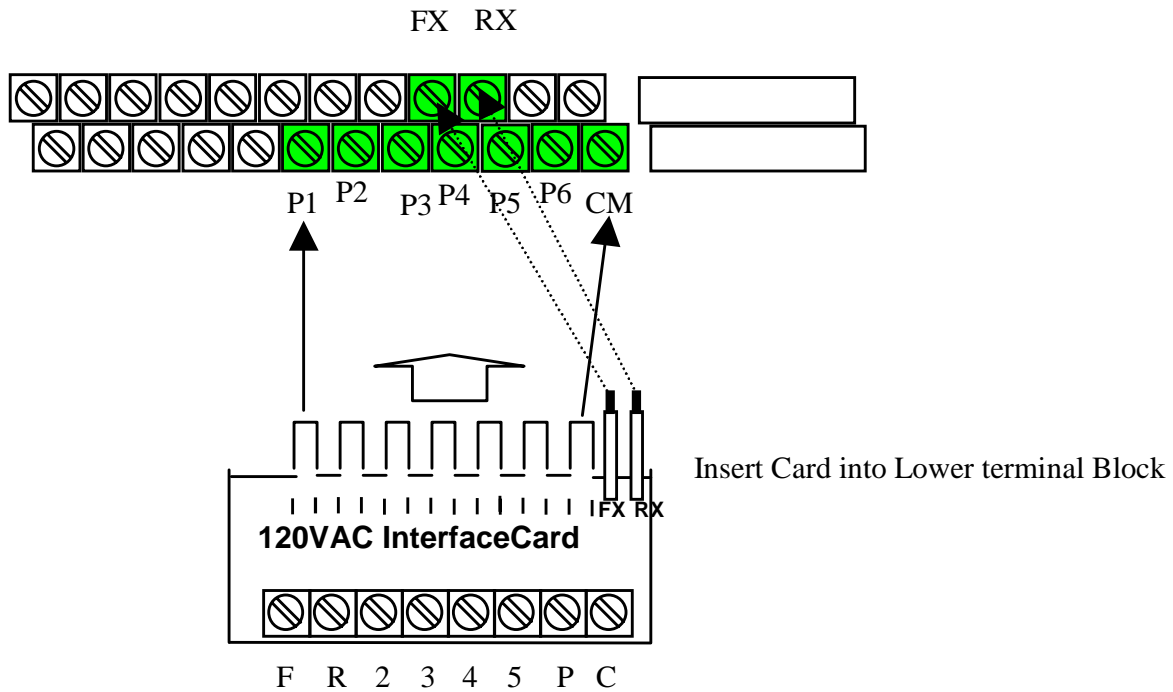

Connect the Pushbutton Pendant Control Wires

Wire the pushbutton pendant control to the pendant input terminals. (See Figure 6 below for wiring diagram). Once the pendant is wired, check to determine that the motor travels in the correct direction with respect to the pendant button depressed. **Note:** The Interface card requires 120VAC input signal from your external pushbutton. The 120VAC is supplied through the FX terminals.

Fig. 6 – Pushbutton Wiring Diagram

120VAC Input from Pushbutton

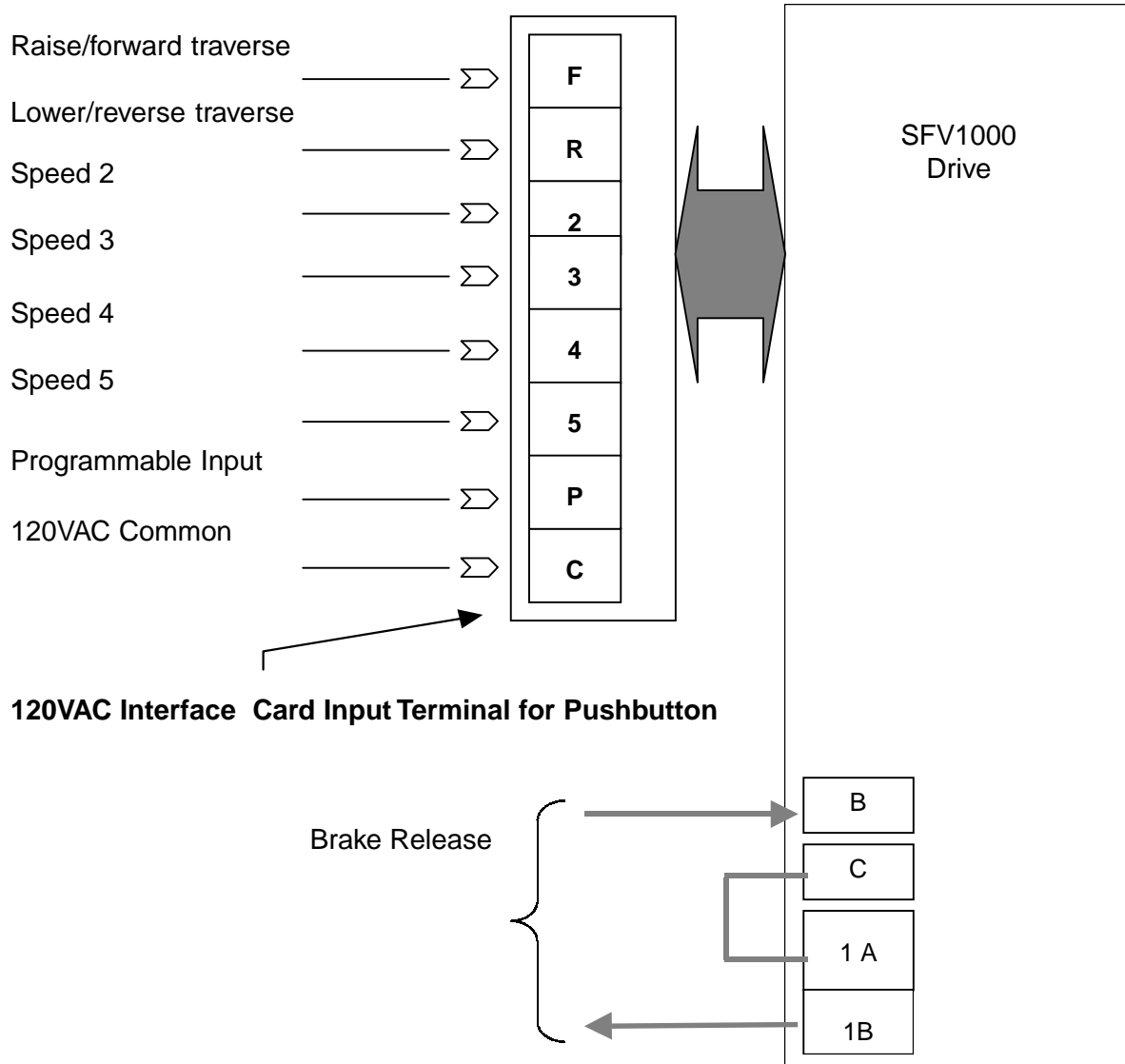

Encoder Selection

There are two types of encoders. You must properly select the correct encoder for your motor. Refer to Figure 7 below for encoder setup.

Fig. 7 - Encoder Selection Diagram

Set Short-Jumper According to Encoder Type

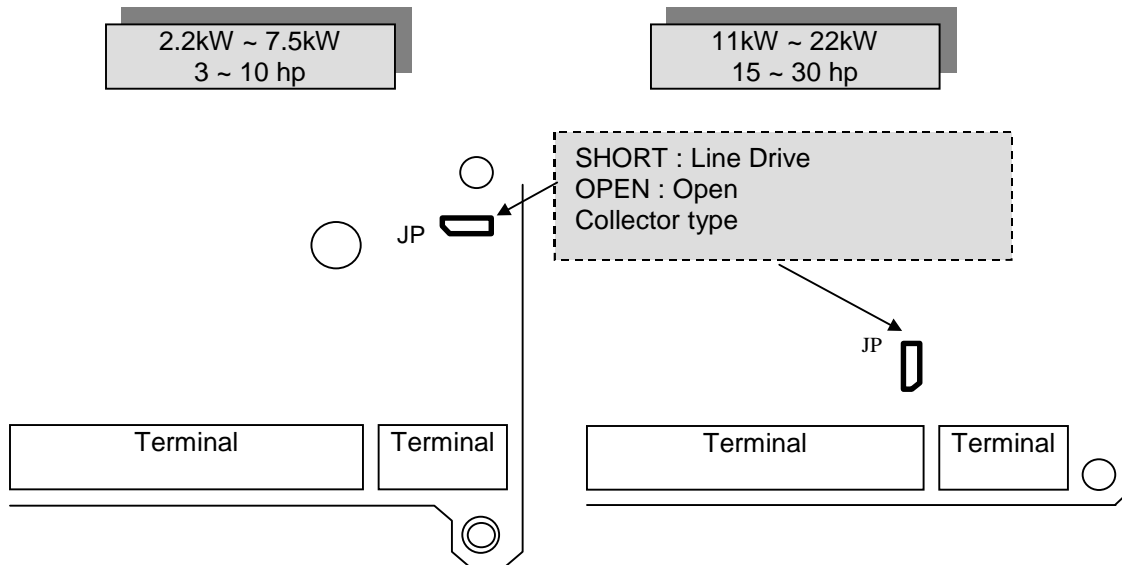

- The default set-up is for Line Drive Encoder.

Encoder Type	Set-up of Jumper
Open Collector	Open
Line Driver	Short

Encoder Wiring

Open Collector Type

Terminal	Open Collector
5G	5G
P15	VCC
PA	PA
PB	PB

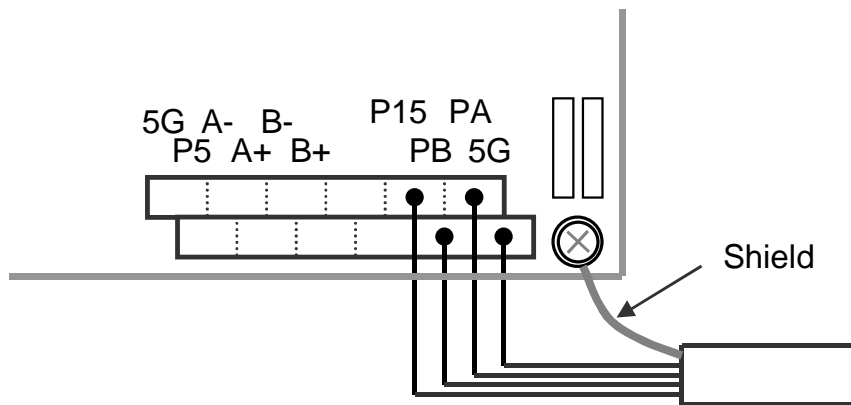
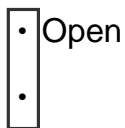

Note: Exposed grounding shield should be approximately one inch. Make sure the grounding shield is attached at the drive end only. Do not attach at the motor end.

Line Driver Type

Terminal	Line Driver Type
P5	5V
5G	5G
A+	A+
A-	A-
B+	B+
B-	B-

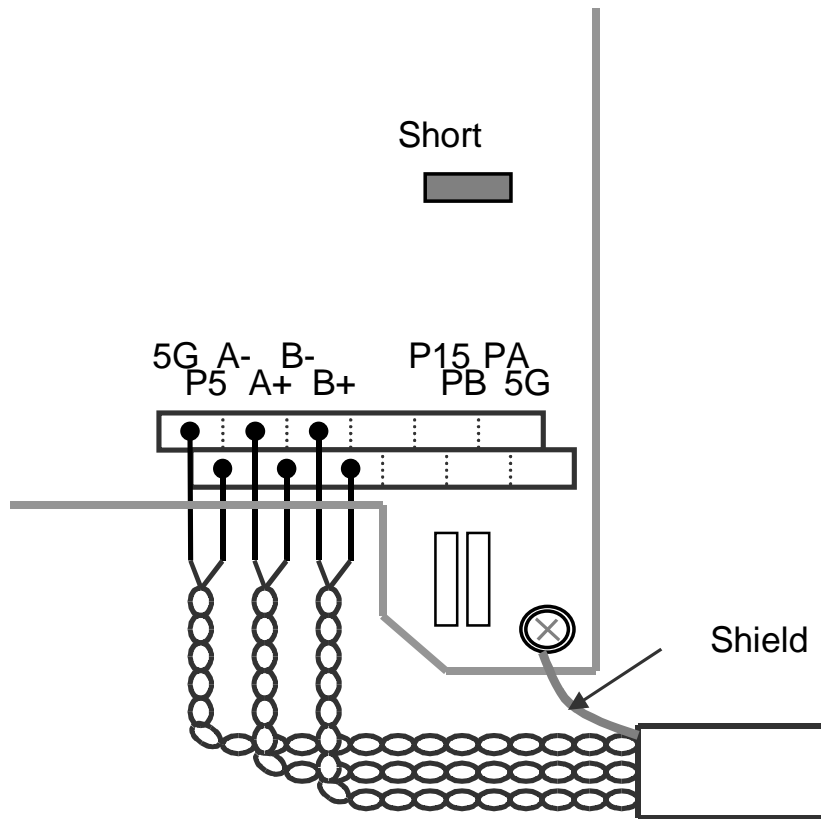

Note: Exposed grounding shield should be approximately one inch. Make sure the grounding shield is connected at the drive end only. Do not connect shield at motor end.

Control Terminal Descriptions

Figure 8 below shows a block diagram showing all the input / output terminals. Refer to Table 1.9 for terminal descriptions.

Fig. 8 - Reference Diagram for Input / Output Terminals.

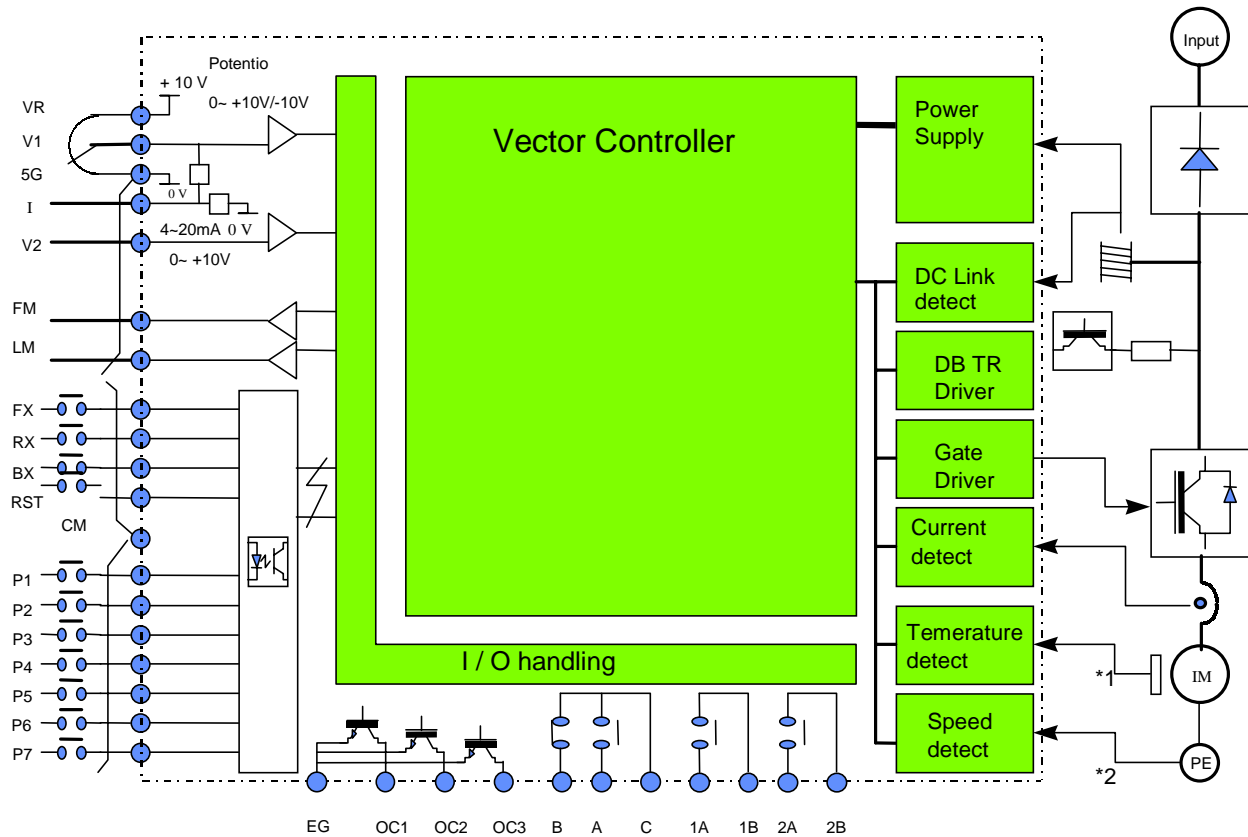

*1 NTC connection for motor temperature (NTC+, NTC-)

*2 Line Driver type encoder (P5, 5G, A+, A-, B+, B-)
Open Collector type encoder (P15, 5G, PA, PB)

Table 1.9 - Control Input / Output Terminal Definitions

	Symbol		Description
Contact Inputs	FX	Forward run	Available when connected to CM terminal.
	RX	Reverse run	Motor stops when both of FX, RX are selected.
	BX	Emergency stop	Available when connected to CM terminal. Free run or deceleration is selected. No fault relay output.
	RST	Reset trip status	Available when connected to CM terminal.
	P1	Multi-function inputs	Each can be defined as one of the 17 functions below: Multi speed select 1, Multi speed select 2, Multi speed select 3, Acceleration and Deceleration time select, Soft start cancel, ASR PI gain select, ASR P/PI select, Flux reference select, Pre-excitation, External trip input (normally closed), Speed / Torque control select, Torque limit ON, Torque bias ON, Forward-run prohibit, Reverse-run prohibit, External trip input (normally open).
	P2		
	P3		
	P4		
	P5		
	P6		
P7			
CM	COMMON	Common terminal for the contact inputs above	
Analog Inputs	VR	+10V output	Reference voltage for potentiometer (+10V)
	V1	Multi-function analog input	V1, V2 : Analog input (-10V)
	I	Current input	I : Analog input (4 ~ 20mA) overridden on V1
	V2	Multi-function analog input	Each can be defined by user for one of 7 functions: Speed reference value, Torque reference value, Flux reference value, Torque limit value, Torque bias value, Outer PI Controller reference value, Outer PI Controller feedback value.
	5G	COMMON	Common terminal for analog inputs
Encoder Signals	P5		+5 V (power supply for line driver encoder)
	5G		V
	A+	A phase	Signals of line driver encoder. For line drive encoder, make sure JP Connector is shorted. See page 22.
	A-		
	B+	B phase	
	B-		
	P15		+15 V (power supply for open collector encoder)
	5G		V
PA	A phase	Signals of open collector encoder. For open collector encoder, make sure JP Connector is open. See page 22.	
PB	B phase		
Analog Output	5G	COMMON	Common Terminal for FM, LM
Open Collector Output	OC1	Multi-function open collector output	Each can be defined by user as one of 11 functions below: Zero speed detection, Speed detection (polarity available), Speed detection (polarity ignored), Speed arrival, Speed deviation, Torque detection, Torque limiting, Motor overheat warning, Inverter overheat warning, Low voltage warning, Inverter running
	OC2		
	OC3		
	EG		
Contact Output	1A	Multi-function relay output (A contact)	
	1B		
	2A		
	2B		
	A	Fault relay (A)	Closed when inverter is tripped
	B	Fault relay (B)	Open when inverter is tripped
C	COMMON	Common for relay (A) and (B)	

Make Precautionary Checks Before Operation

1. Make sure the input voltage level to the drive is correct. Refer to the Drive Specification Tables 1.2 and 1.3.
2. Check the power and control connections. All wires should be connected tightly to the terminal.
3. Check the 120VAC source for the control push button.
4. The length of the output wires between the SFV1000 and the motor must not exceed 75 feet.
5. Check the drive and motor ground and make sure there is no ground loop problem.
Example:

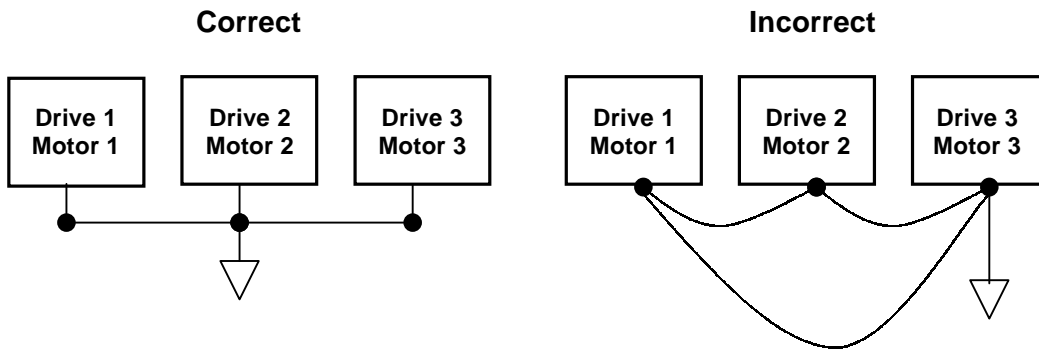

Section 2: Start Up Programming

Step 1: Keypad Layout

Step 2: Keypad Operation

Definitions

Moving through each Group Level

Viewing a Specific Function [Code No.] Using Jump Code Location

Viewing all Functions [Code No.'s] within a Group Level

Function Code List

Step 3: Auto Tuning

Step 4: Initial Setup Programming

Programming the Drive for a Specific Application

Programming the Speed Selection

Drive Operation Checks

Step 1: Keypad Layout

The SFV1000 uses a 32 alphanumeric LCD display for easy reading. All drive functions can be accessed via keypad. The keypad has the capability of uploading or downloading data from the drive. Programming is easy when utilizing the parameter descriptions on the LCD display.

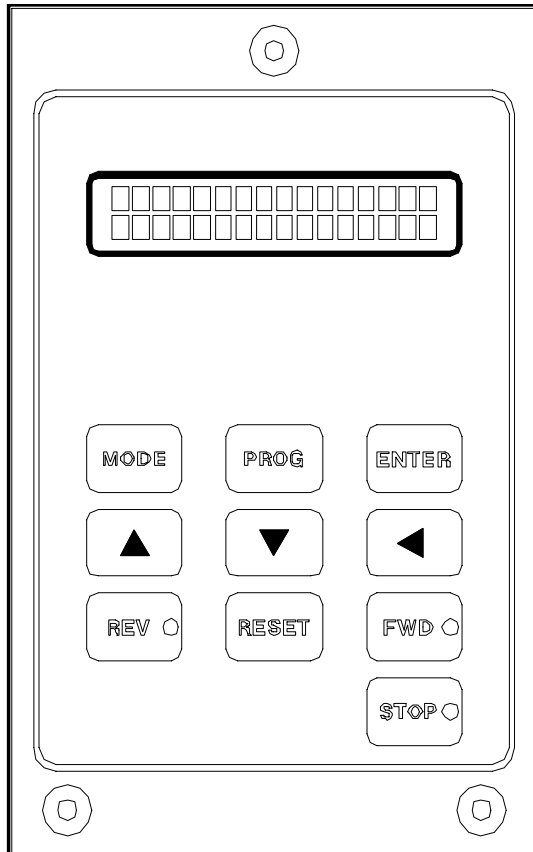

MODE: Press to access different levels of programming (User, Service, Advance).

PROG: Press to begin to change drive parameter data.

ENTER: Saves the changed data of the parameter.

ARROWS: Used to scroll through parameter function codes in each level. Also used to increment and decrement the parameter data value.

REV: Run in reverse/down direction. LED is blinking during Accel./Decel.

FWD: Run in forward/up direction. LED is blinking during Accel./Decel.

STOP: Stop running. LED is blinking during Decel. (w/Stop Command)

RESET: Reset drive faults.

Alphanumeric Display

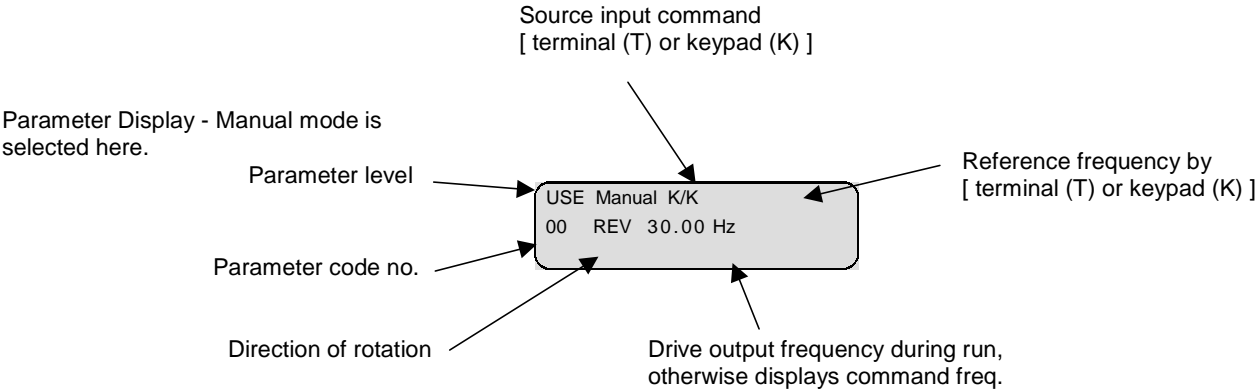

Step 2: Keypad Operation

Keypad operation and moving through the parameters of each group access level is a straight forward process. First read the definitions below.

Definitions

Group Levels – The SFV1000 program consists of three group levels. The levels are the User, Service, and Advanced. Each level consists of different function commands which control how the drive operates, senses, and performs.

User Level – (USE on The SFV1000 Display) - This level allows programming speed, passwords, and the motion application desired. You can also monitor motor current draw and system faults in this level. **You are automatically in the User level upon power up of your drive.**

Service Level (SER on The SFV1000 Display) – The functions within this group primarily set how the drive will perform, sense problems, and set parameters catered to your motor for peak operation.

Advanced Level (ADV on The SFV1000 Display) – Functions within this level are reserved for special performance characteristics and consists of advanced performance parameters.

Moving Through The Program

Begin by powering up the drive. We will now begin to press a sequence of keys and move through the three levels and their respective functions to show the pattern of how the programs flow.

When the power of the drive is first turned on, you are in the **User Level** with the first function code displayed. Please follow the keypad button prompts illustrated in Figures 9, 10 and 11 on pages 32-34 and use **Table 2.1 - Function Code List For All Levels** on pages 35-39 to help follow how the program flows.

Fig. 9 – Programming flowchart showing how to move through each group level.

Moving Through Each Group Level

Whatever function you are in, whatever group level, the quickest way to move from group level to group level is by following the below procedure. In this example, the user is currently in the **User Level** [Code No. 04 Speed 1].

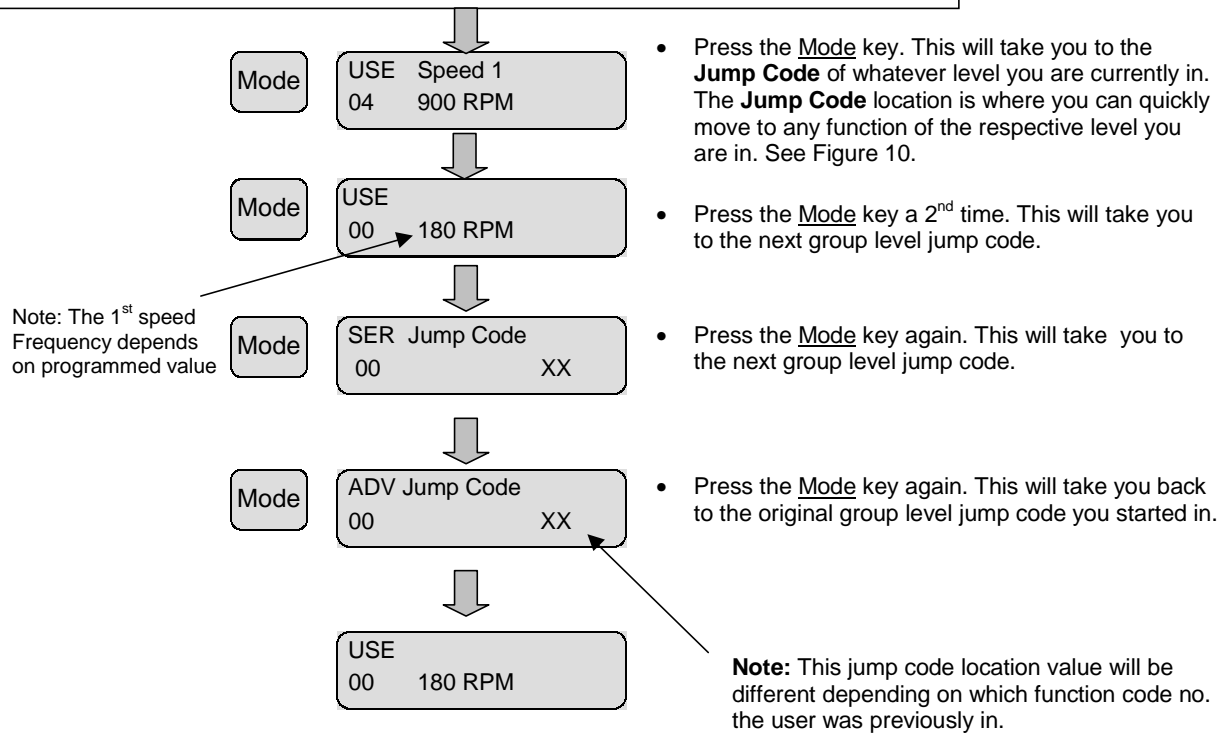

- To see how to view each function code no. in a group level, reference Figures 10 and 11 on pages 33-34.

Fig. 11 – Programming flowchart showing how to view all function [Code No's.] of a group level.

Viewing All Function [Code No's.] Within a Group Level

In this example, the user is currently located in the **Advanced Level** at Code No. 00.

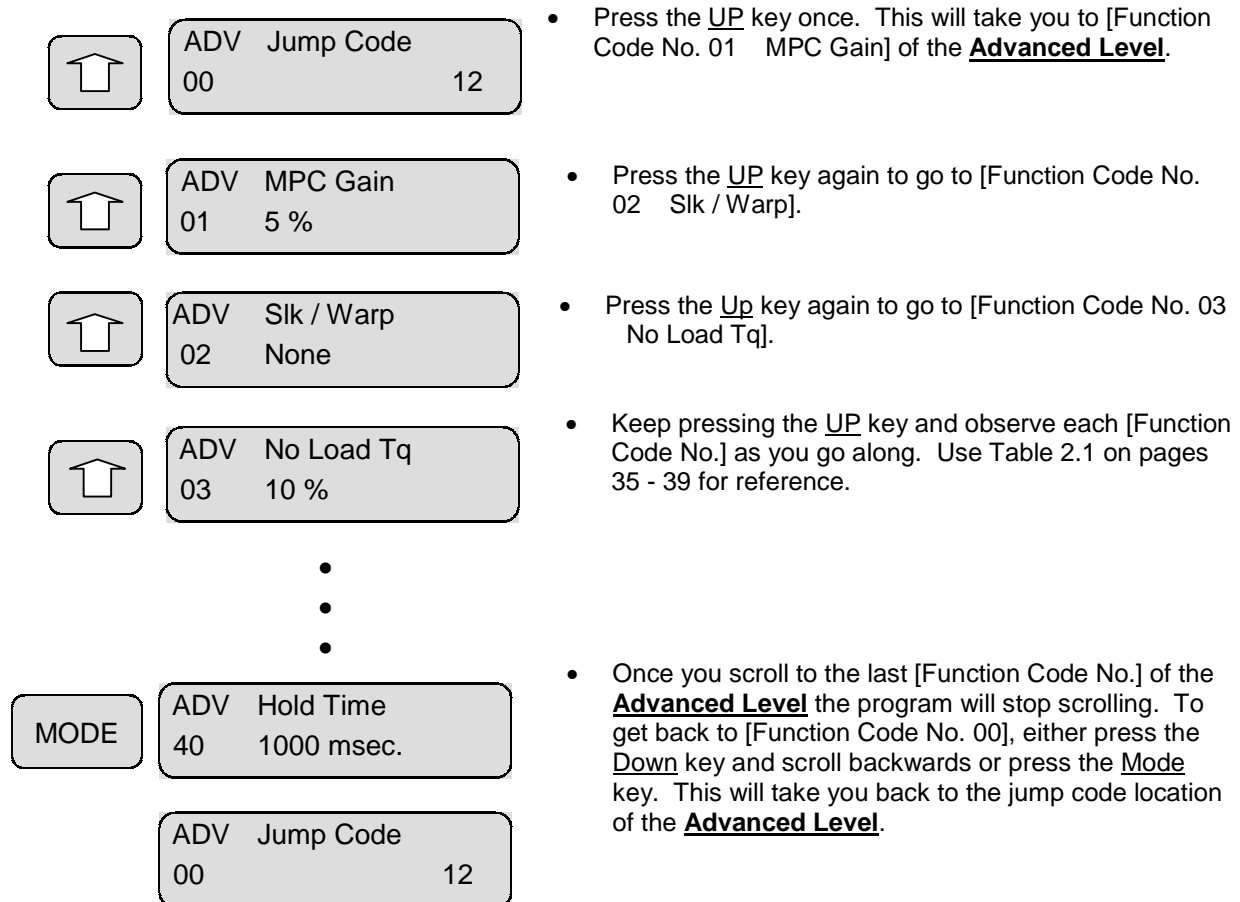

- The procedure above is the same for the **Service Level**
- In the **User Level**, you can scroll to [Function Code No. 00.]

Table 2.1 - Function Code List For All Levels

Level	Code No.	Display	Data			Description	
			Range	Unit	Initial		
User	0	Speed, Torque, Mode				Display Only (Speed, Torque, Control Mode, Current)	
	1	Speed Ref				Display Only (Speed Reference)	
	2	Motion Def	Traverse Hoist w/ LB Hoist w/o LB		Hoist w/o LB	Macro Setup for Machine	
	3	Speed Sel	2 Step 2 Step Inf Var 3 Step 3 Step Inf Var 5 Step		3 step	Macro Setup for Speed Step	
	4	Speed 1	0 ~ Ser_ 38	RPM	180	Multi-Step Speed Initial Data depends on the macro Setup for Speed step. (User_3)	
	5	Speed 2			900		
	6	Speed 3			1750		
	7	Speed 4			0		
	8	Speed 5					
	9	ACC time - 1	0 ~ 3600	Sec.	1.5		
	10	DEC time - 1					
	11	LSW Speed	0 ~ Ser_ 36	RPM	150		
	12	Slack Speed			0		
	13	Motor Pow					Display Only (Motor Output Power)
	14	DC_BUS Volt					Display Only (DC Link Voltage)
	15	Output Volt					Display Only (Inverter Output Voltage)
	16	Temp				Display Only (Inverter Heatsink Temp.)	
	17	Flux Ref				Display Only (Flux Reference)	
	18	Ter. Input				Display Only (Status of Input Terminal) 0 : OFF / 1 : ON FX RX BX P1 P2 P3 P4 P5 P6 P7 0 0 0 0 0 0 0 0 0 0	
	19	Ter. Output				Display Only (Status of Output Terminal) 0 : OFF / 1 : ON OC1 OC2 OC3 1A 2A Fault Relay 0 0 0 0 0 0	
	20	Faults				Display Only (Normal / Fault Trip)	
	21	P1 Faults				Display Only (Previous Fault 1)	
	22	P2 Faults				Display Only (Previous Fault 2)	
	23	Access Lev				Display Only (Permitted Access Level)	
	24	Password				Enter Password	
	25	Ser Lev PW				Change Service Level Password	
	26	Adv Lev PW				Change Advanced Level Password	
27	S/W Ver.				Software Version		

Table 2.1 - Function Code List For All Levels (continued)

Level	Code No.	Display	Data			Description
			Range	Unit	Initial	
Service	0	Jump Code	0 ~ 47	1	0	Jump Code
	1	RUN/STOP sel	Pendant Keypad		Pendant	Select RUN/STOP method
	2	Br CHK Speed	0 ~ Ser_36	RPM	100	Brake Check Speed
	3	Br CHK Bias	0 ~ 150	%		Brake Check Torque
	4	Br CHK Time	0 ~ 1500	msec	500	Time Period for Brake Check Sequence
	5	Br MECH dly	0 ~ 5000			Mechanical Delay Time of Brake
	6	Br Answer T			300	Brake Release Check Time
	7	Float Time	0 ~ 30000		1000	Time Period for Floating Load
	8	Br Err Speed	0 ~ Ser_36	RPM	100	Speed Boundary for Brake Fault
	9	SEQ Band	0 ~ 30	%	10	Speed Boundary for Speed Deviation Fault
	10	ACC Time - 2	0.1 ~ 3600	sec	1.5	Acceleration 2
	11	DEC Time - 2				Deceleration 2
	12	ACC St -1	0 ~ 50	%	0.0%	S Curve Rate for Acceleration 1
	13	DEC ST -1				S Curve Rate for Deceleration 1
	14	ACC ST - 2				S Curve Rate for Acceleration 2
	15	DEC ST - 2				S Curve Rate for Deceleration 2
	16	P1 Input	Not used Spe Sel 1 Spe Sel 2 Spe Sel 3 Spe Sel 4 LSW Imm Stop LSW Rmp Stop LSW Low Spd Micro Pos AccDec Time Soft Start Cncl Flux Ref Sel PreExcitation EXIT Trip B EXIT Trip A Use Max Trq. Auto Tune ON		SPD SEL I	Define Multi-function input
	17	P2 Input				
	18	P3 Input				
	19	P4 Input				
	20	P5 Input				
	21	P6 Input				
22	P7 Input					

Table 2.1 - Function Code List For All Levels (continued)

Level	Code No.	Display	Data				Description
			Range	Unit	Initial		
Service	23	AX1 Output	Not Used		Brake Control	Multi-function Output Macro Setup for Motion Define sets these outputs automatically.	
	24	AX2 Output	Zero Spd Det		Alarm Buzzer		
	25	OC1 Output	Spd Det Pole		Not Used		
	26	OC2 Output	Spd Det No Pole		Not Used		
	27	OC3 Output	Spd Arrive		Slack Cable		
			Spd Deviation				
			Trq Det.				
			Trq. Lmt Det.				
			Mot OH Warn				
			Inv OH Warn				
			LV Warn				
			Inv RUN				
			Inv Ready				
			Brake Control				
		Alarm Buzzer					
		Slack Cable					
	28	ASR P-Gain 1	0 ~ 200	%	50	ASR (Automatic Spd Regulator) P gain	
	29	ASR I-Gain 1	0 ~ 5000	msec	300	ASR (Automatic Spd Regulator) I gain	
	30	ASR LPF 1	0 ~ 2000		0	ASR LPF Time constant	
	31	FWD Lmt	0 ~ 250	%	150	Forward Torque Limit	
	32	REV Lmt				Reverse Torque Limit	
	33	REG Lmt				Regeneration Torque Limit	
	34	Inv Capacity	3hp @ 230V 5hp @ 230V 7.5hp @ 230V 10hp @ 230V 15hp @ 230V 20hp @ 230V 25hp @ 230V 30hp @ 230V 3hp @ 460V 5hp @ 460V 7.5hp @ 460V 10hp @ 460V 15hp @ 460V 20hp @ 460V 25hp @ 460V 30hp @ 460V			Inverter Power Rating	
	35	Motor Capacity	3hp @ 230V 5hp @ 230V 7.5hp @ 230V 10hp @ 230V 15hp @ 230V 20hp @ 230V 25hp @ 230V 30hp @ 230V 3hp @ 460V 5hp @ 460V 7.5hp @ 460V 10hp @ 460V 15hp @ 460V 20hp @ 460V 25hp @ 460V 30hp @ 460V			Motor Power Rating	

Table 2.1 - Function Code List For All Levels (continued)

Level	Code No.	Display	Data			Description
			Range	Unit	Initial	
Service	36	MAX Speed	0 ~ 3600	RPM	1800	Maximum Speed of Operation
	37	Base Speed			1500	Rated Speed of Motor
	38	Enc Pulses	500 ~ 8000	Pulse	1024	Pulses per Revolution of Encoder
	39	Enc LPF	0 ~ 30	msec	0	LPF Time Constant for Encoder Feedback
	40	Spd Ref Src	Keypad Analog Input		Keypad	Select a Source for Speed Reference
	41	V1 Gain	0 ~ 250	%	100%	Gain for Analog Input
	42	V1 Bias	-100 ~ 100		0%	Bias for Analog Input
	43	V1 LPF	0 ~ 2000	msec	0 msec	Low Pass Filter Time Constant
	44	Para Read				Parameter Write from Main Memory to Keypad
	45	Para Write				Parameter Write from Keypad to Main Memory
	46	Para Init				Initialize Parameters by Factory Setting
	47	Para Lock				Lock Changing Parameters
Advanced	0	Jump Code				Jump Code
	1	MPC Gain	0 ~ 100	%	5	Gain for Micro-Positioning
	2	Slk/Warp	None Slack		None	Slack line detection
	3	No Load Tq	0 ~ 50	%	10	No Load Torque for Slack Function
	4	Warp Gain	100 ~ 200		120	
	5	Base Volt	0 ~ 460	V	230	Rated Voltage of Motor
	6	Rated Cur	0 ~ *1	A	*1	Rated Current of Motor *1: Depending on Setting of Motor Power Rating
	7	No Load Cur	0 ~ Adv_6		*2	No Load Current of Motor *2: Initial Data is for Special Vector Motor
	8	Pole Number	2 pole - 3600 rpm 4 pole - 1800 rpm 6 pole - 1200 rpm 8 pole - 800 rpm		4 pole	Number of Motor Pole
	9	Rated Slip	30 ~ 100	RPM	60	Rated Slip of Motor

Table 2.1 - Function Code List For All Levels (continued)

Level	Code No.	Display	Data			Description	
			Range	Unit	Initial		
Advanced	10	Auto Tune	None ALL 1 ALL 2 Pre Tr Calc Encoder Test Rs Lsigma 1 Flux Tr		None		
	11	Tune Trq	0.1 ~ 100	%	30	Torque Level Used in Auto Tuning Process	
	12	Tr	30 ~ 1500	msec	*3	Rotor Time Constant of Motor *3:Initial Data is for Special Vector Motor	
	13	Ls	0 ~ 300	mH		Parameters of Applied Motor Initial data is for Special Vector Motor	
	14	SigmaLS	0 ~ 30	mH			
	15	Rs	0 ~ 3000	mohms			
	16	Iron Loss	0 ~ 100	%			
	17	Core Sat 1	100 ~ 200				
	18	Core Sat 2	Adv_11 ~ 200				
	19	Core Sat 3	Adv_12 ~ 200				
	20	Core Sat 4	Adv_13 ~ 200				
	21	Core Sat 5	Adv_14 ~ 200				
	22	ACR P-Gain	0 ~ 20000		10000		ACR P Gain
	23	ACR I-Gain	0 ~ 10000		300	ACR I Gain	
	24	ACR LPF	0 ~ 2000	msec	10	ACR LPF Time Constant	
	25	Sw. Freq	2.5kHz 5kHz 10kHz		10kHz	Carrier Frequency of PWM	
	26	Fan Control	YES NO		No	YES : ON/OFF Control of Fan NO : Continuous ON of Fan	
	27	Motor NTC	YES NO		No	YES : Special Vector Motor NO : Other Motors	
	28	ZSD Level	0 ~ 360	RPM	10	Zero Speed Detection Level	
	29	ZSD Band	0.1 ~ 10	%	0.1		
	30	SD Level	-3600 ~ 3600	RPM	0	Speed Detection Level	
	31	SD Band	0.1 ~ 10	%	0.1		
	32	SA Band					Speed Arrival Detection Level
	33	TD Level	0 ~ 250		0		Torque Detection Level
	34	TD Band	0.1 ~ 10		0.1		Torque Detection Band
	35	MH Level	75 ~ 150		C	140	Motor Temperature Detection Level
	36	MH Band	0 ~ 10	5		Motor Temperature Detection Band	
	37	IH Level	50 ~ 85	75		Inverter Temperature Detection Level	
	38	IH Band	0 ~ 10	5		Inverter Temperature Detection Band	
	39	BX Time	0 ~ 3600	sec	.1	Deceleration Time When BX is input	
	40	Hold Time	0 ~ 5000	msec	1000	Hold Time at Stop	

Step 3: Auto Tuning

SFV1000 Flux Vector Drive Start-Up Procedure

Procedure 1: Connect Wires

- A. Connect the AC power source to terminal inputs **R**, **S**, and **T** of the inverter.
- B. Connect the Motor leads to the **U**, **V**, and **W** terminals of the inverter.
- C. Connect the DB (Dynamic Braking) resistor to terminals **B1** and **B2** of the inverter.
- D. Make sure motor earth ground is connected to the **E** terminal of the inverter.
- E. Properly connect the motor encoder. See Figure 11 on page 22 and pages 23-24 for reference.

Procedure 2: Initial Programming of Drive

- A. Initialize all function codes to factory default parameters. (SER: Code No. 46)
- B. Verify the inverter capacity is set correctly. (SER: Code No. 34)
- C. Verify the motor capacity is set correctly. (SER: Code No. 35)
- D. Set the correct maximum mechanical speed (rpm) (SER: Code No. 36)
- E. Set the correct base speed of the motor (rpm) (SER: Code No. 37)
- F. Set the correct number of poles of the motor. (ADV: Code No. 8)
- G. Set the rated voltage of motor. (ADV: Code No. 5)
- H. Set the rated current (full load amps) of motor. (ADV: Code No. 6)
- I. Set the rated no load current of motor. (ADV: Code No. 7)
- J. Set the number of encoder pulses (ppr). (SER: Code No. 38)

Procedure 3: Check Encoder Wiring

- A. Make sure the motor shaft is decoupled at this time.
- B. Power up input (L1, L2, L3)
Note: Do Not press the Up/Forward or Down/Reverse

Important: Determining the direction your motor must turn to achieve the forward/up direction of your equipment is very important. In many cases turning the motor shaft counter clockwise is the forward/up direction. However, there maybe some equipment where rotating the motor shaft in the clockwise direction is the forward/up direction. Determine the correct motor rotation for forward/up movement and follow the next procedure accordingly.

- C. Rotate motor shaft by hand in the forward direction.
View the speed feedback display located in the User Level of programming, (USE: Code No. 00).
If the display shows (+XX.XX), then the encoder wiring is correct. If the display shows (-XX.XX), then do the following:
- D. Rotate the motor shaft by hand in the reverse direction.
Make sure the display shows (-XX.XX).

Note: If the encoder is located on the shaft of the motor, you will have to reverse any two of the U, V or W output wires at the drive output. This will ensure the above shaft rotation procedure will work correctly.

Procedure 4: Check Motor Wiring

- A. Program the 1st speed (USE: Code No. 04) to approximately 100 rpm.
- B. Press the Up/Forward of your control.
 - View the display at (USE: Code No. 00) and see if the motor is running at +100rpm without any vibration.
 - If the motor is rotating in the reverse direction at around 30 – 40 rpm, Interchange any two of the U, V, W outputs.
 - If the motor is cogging (not moving) or vibrating severely, check the wiring and grounding from the encoder for loose connections. If everything seems to be O.K., then set the speed down to 0 rpm. Adjust the forward and reverse torque limit down 20% from its original value. If the cogging or severe vibrations stops, then the encoder is o.k. If not, the signal from the encoder is very noisy. Check the shield wiring for proper grounding. **Note:** Encoder shield wiring must only be connected at the inverter end. Do not connect shield at the motor end. This would create an antennae for noise. Next check wires (PA) and (PB) with an oscilloscope.
- C. Press the Down/Reverse and verify the motor is running in the correct rotation.

Procedure 5: Run Drive at High Speed

- A. Set the 1st speed of the drive to the motors rated maximum rpm.
- B. Press the Up/Forward and the Down/Reverse and make sure the motor is running in the right direction and at the correct rpm.
Note: If an Over Voltage Fault occurs at deceleration, check the dynamic braking resistor for proper ohmage and connection.

Procedure 6: Auto Tune the Drive

The motor parameters – stator resistance (Rs), stator inductance (σ Ls), no load current (NLA) and rotor time constant (Tr) are very important for flux vector control. The purpose of auto tuning is to find these parameters automatically by the drive.

- A. The motor shaft should remain uncoupled at this time.
- B. Program (ADV: Code No. 10) for '**All 2**'. Running (All 2) determines the following:
 - The drive first calculates (Tr) using the preset data – rated slip (ADV: Code No. 9), rated current (ADV: Code No. 6) and no load current (ADV: Code No. 7). This is not a result of auto tuning.
 - The drive then performs the encoder test. The motor will rotate at 1800 rpm in the forward direction. If the this test fails, there are two possible messages:
 1. **AB Changed** – This means the encoder (A) and (B) signal wires should be interchanged with each other.
 2. **Encoder Err** – This means the encoder has a serious problem in the (A) and/or (B) phase. The wiring of the encoder must be checked.
 - The drive next performs (Rs) tuning.
 - The drive next performs L-sigma (σ Ls) tuning.
 - The drive next performs I-Flux tuning. The motor will rotate at 1800 rpm and determine the no load current (flux current). **Note:** This may take several minutes.
 - The drive next performs (Tr) tuning. The motor will accelerate and decelerate repeatedly in order to find the proper (Tr).
 - If everything checks O.K., the drive will display '**Success**'. The following flowchart depicts the auto tune process.

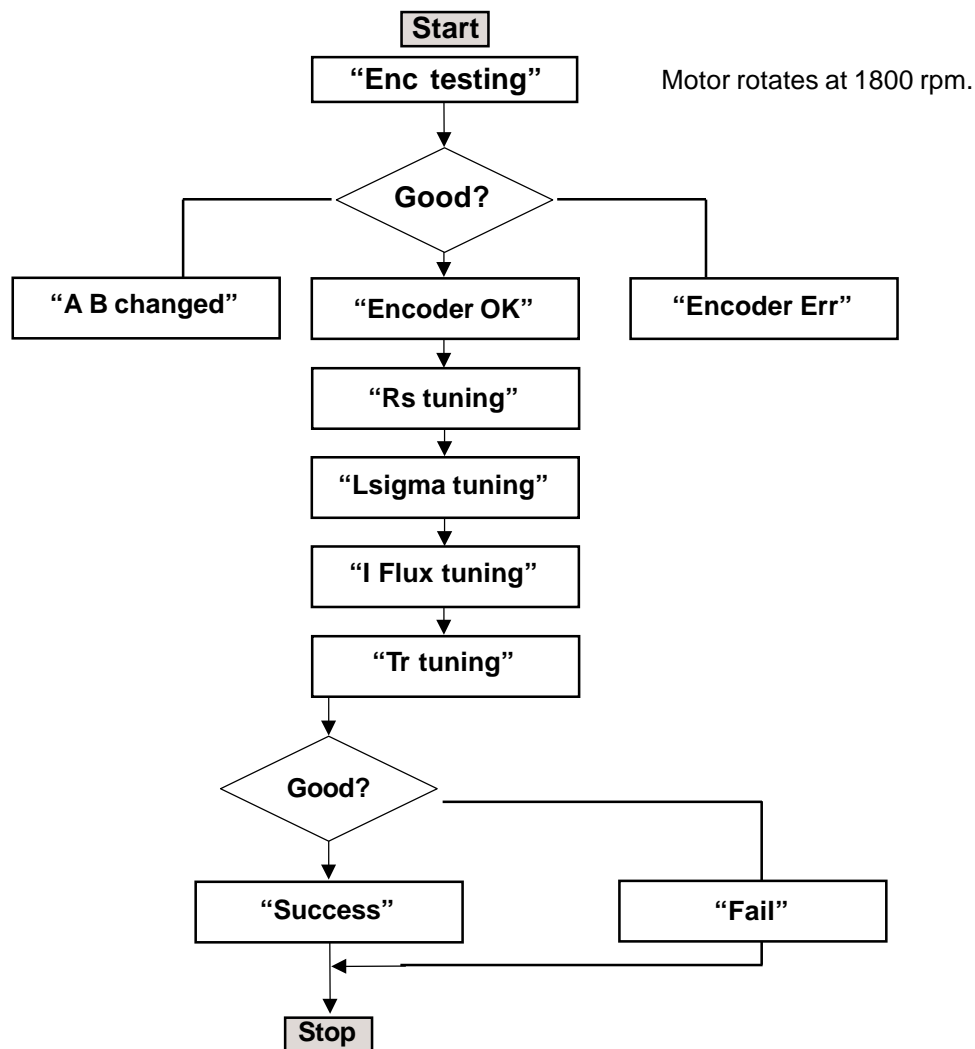

Procedure 7: Upload Auto Tune Information into Keypad

- A. Go to the Service Level of programming (SER: Code No. 44). 'Para Read' will be displayed. Program the parameter to say **Yes** and hit the **Enter Key** to execute. This procedure will upload all function data from the drive to the keypad.

Procedure 8: Test with Load

- A. Couple the motor.
- B. Attach full load to the hoist.
- C. Set 1st speed (USE: Code No. 4) to 10% of motor rated rpm. Run the motor in both directions and make sure there is:
 - Exact Speed without any ripple. This can be viewed at (USE: Code No. 00).
 - No faults.
 - No vibration or noise.
- D. Set the 1st speed (USE: Code No. 4) to 50% of motor rated rpm and repeat the previous step.
- E. Set the 1st speed (USE: Code No. 4) to 100% of motor rated rpm and repeat the previous step again.

Note the following:

 - If an over current fault occurs at the end of ramping, decrease (ADV: Code No. 12) which will be 'Tr' on your display, 10% - 20% from its original value.
 - If a speed control fault occurs at the end of ramping, increase (ADV: Code No. 12) 10% - 20% from its original value.
 - If the hoist vibrates during traveling, check the encoder alignment with the motor shaft.

Step 4: Initial Set Up Programming

Programming the Drive for a Specific Application

Initial setup programming involves a few easy steps. Follow the Macro Quick Set Programming instructions shown in Figure 12 below and shortly, your drive will be ready for operation.

Fig. 12 – Programming application flowchart.

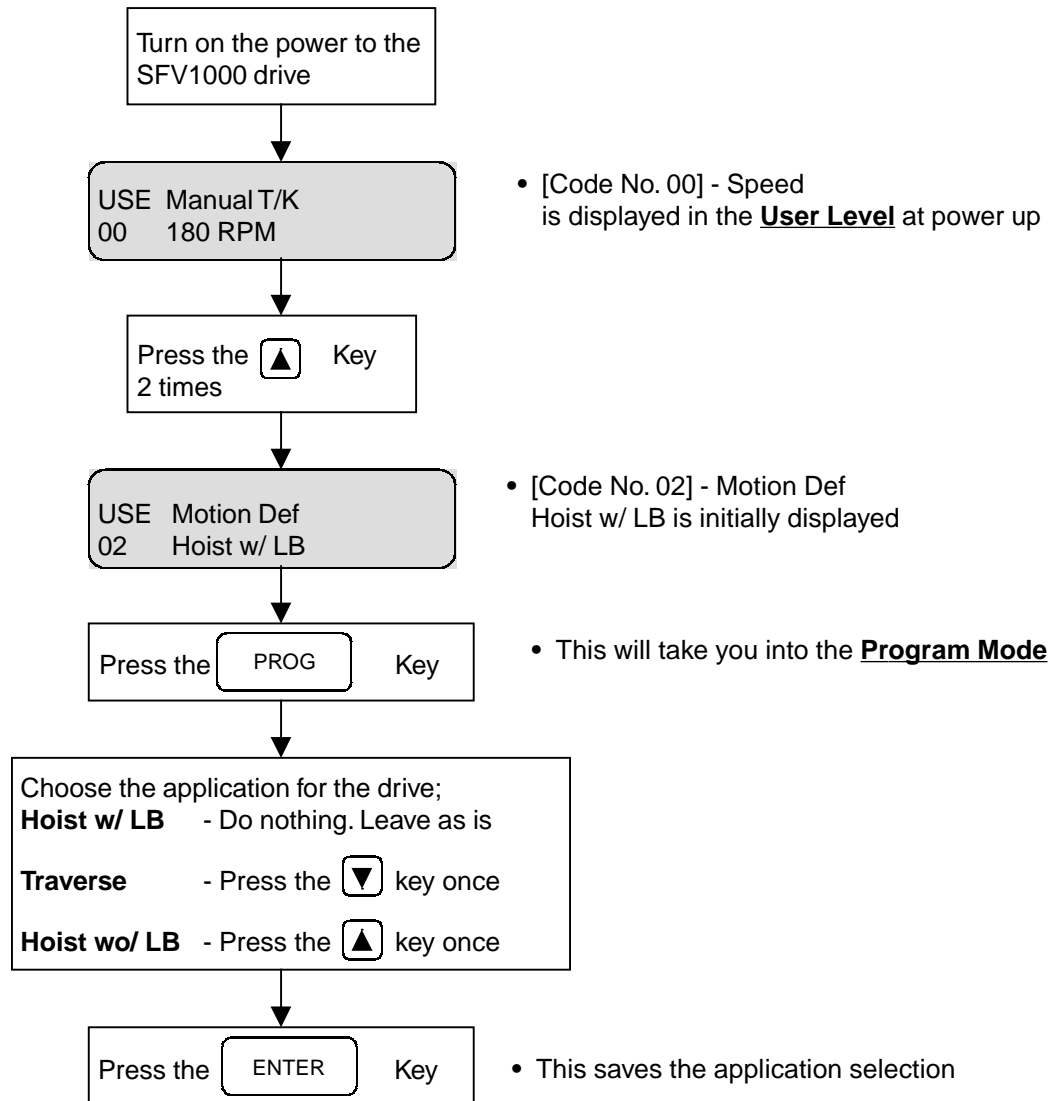

*You have just programmed the drive for it's appropriate application. According to your new selection, other related drive parameters have conveniently changed automatically for quick programming.

Reference Table 2.2 below for function parameters affected by the Macro Quick Set Programming procedure in Figure 12. **Note:** If so desired, these values can be changed individually by entering the respective access level and changing the function data.

Table 2.2 – Macro Quick Set Programming values for motion application selection.

Macro Set-Up for Traverse

Access Level	Code No.	Description	Initial Data	
User	3	Speed Sel	2 Step	
	4	Speed 1	180 RPM	
	5	Speed 2	1750 RPM	
	6	Speed 3	0 RPM	
	7	Speed 4	0 RPM	
	8	Speed 5	0 RPM	
	9	ACC Time - 1	3.0 sec	
	10	DEC Time - 1	3.0 sec	
	Service	2	Brake Check Speed	0 RPM
		3	Brake Check Bias	0%
4		Brake Check Time	0 msec	
5		Brake Mech. Delay	300 msec	
6		Brake Answer Time	500 msec	
7		Float Time	0 msec	
8		Brake Error Speed	100 RPM	
12		ACC ST - 1	20%	
13		DEC ST - 1	20%	
16		P1 Input	Speed 1	
17	P2 Input	Not Used		
18	P3 Input	Not Used		
19	P4 Input	Not Used		
20	P5 Input	Not Used		

- Brake Proving is cancelled for Traverse Motion
- 2 Step is default setting for Traverse Motion

Macro Set-Up for Hoist W/ Load Brake

Access Level	Code No.	Description	Initial Data
User	9	ACC Time - 1	1.5 Sec.
	10	DEC Time - 1	1.5 Sec.
Service	2	Brake Check Speed	100 RPM
	3	Brake Check Bias	100%
	4	Brake Check Time	500 msec
	5	Brake Mech. Delay	300 msec
	6	Brake Answer Time	500 msec
	7	Float Time	500 msec
	8	Brake Error Speed	150 RPM
	12	ACC ST - 1	0 %
	13	DEC ST - 1	0%

Macro Set-Up for Hoist w/o Load Brake

Access Level	Code No.	Description	Initial Data
User	9	ACC Time - 1	1.5 Sec.
	10	DEC Time - 1	1.5 Sec.
Service	2	Brake Check Speed	100 RPM
	3	Brake Check Bias	100%
	4	Brake Check Time	500 msec
	5	Brake Mech. Delay	500 msec
	6	Brake Answer Time	500 msec
	7	Float Time	500 msec
	8	Brake Error Speed	100 RPM
	12	ACC ST - 1	0%
	13	DEC ST - 1	0%

- Typically, these settings will be appropriate for most applications however, you can make individual changes if so desired.

Programming the Speed Selection

The last step for initial setup programming is selecting the speed for the respective application. Follow the flowchart shown in Figure 13 below.

Fig. 13 – Speed selection flowchart.

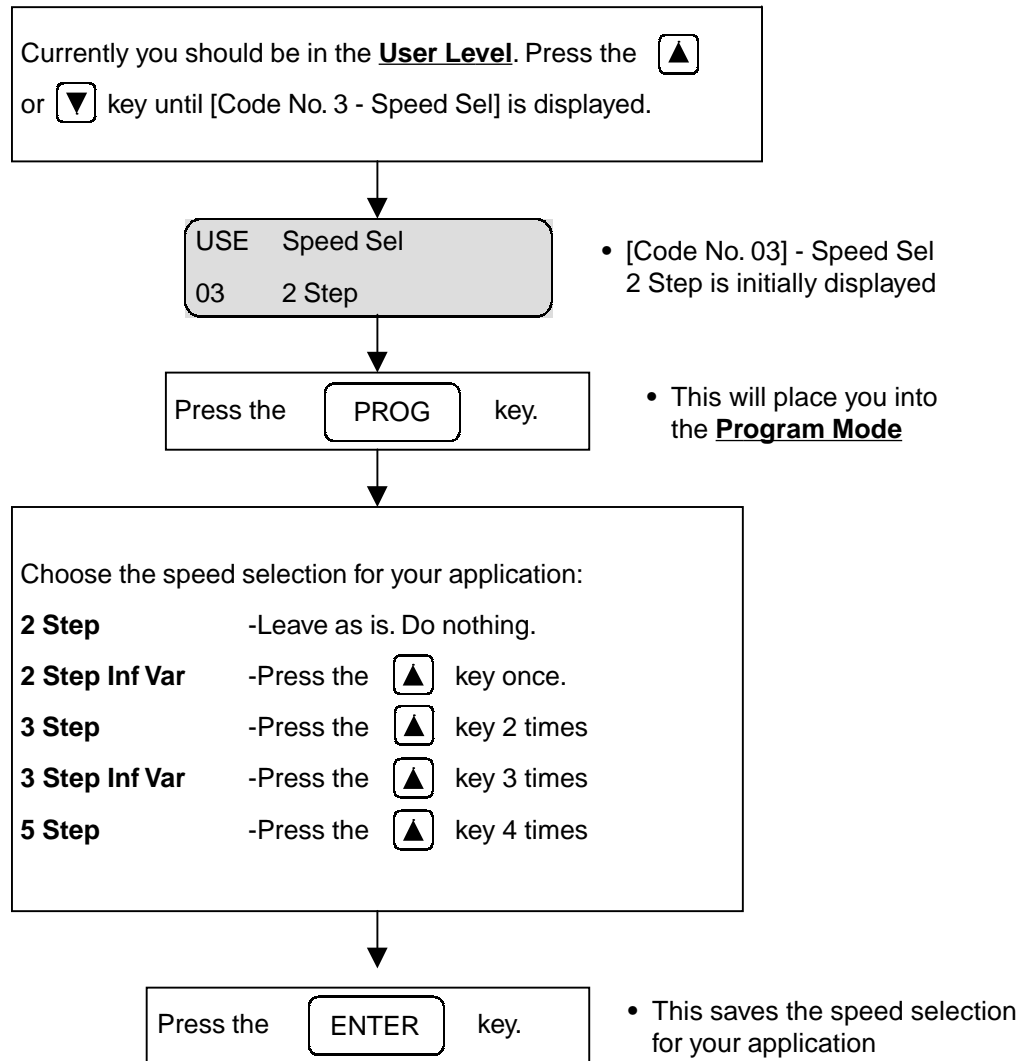

* You have now programmed the drive for its 'pushbutton speed command'. According to your new selection, other related drive parameters have also changed automatically for quick programming. See Table 2.3 on pages 44 - 46 for changes.

Table 2.3 – Parameters Affected With Speed Selection Programming.

• 2 Step

Access Level	Code No.	Description	Initial Data
User	4	Speed 1	180 RPM
	5	Speed 2	1750 RPM
	6	Speed 3	0 RPM
	7	Speed 4	0 RPM
	8	Speed 5	0 RPM
Service	16	P1 Input	Speed 1
	17	P2 Input	Not Used
	18	P3 Input	Not Used
	19	P4 Input	Not Used
	20	P5 Input	Upper Limit Switch

2 Step

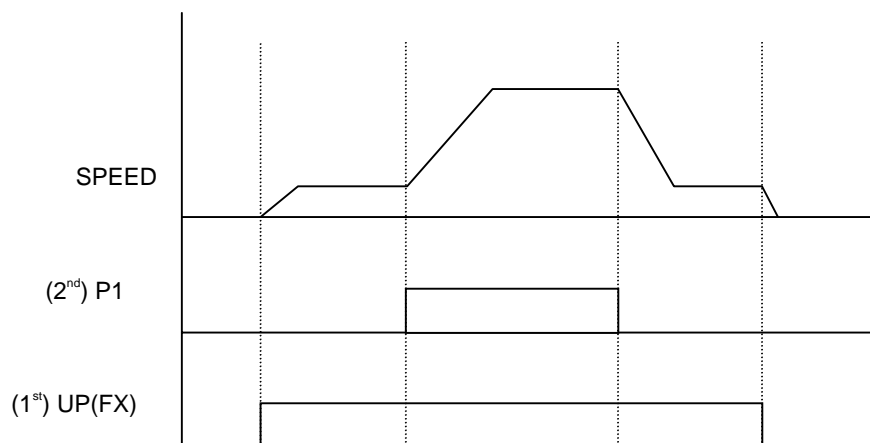

• 2 Step / Infinitely Variable

Access Level	Code No.	Description	Initial Data
User	4	Speed 1	180 RPM
	5	Speed 2	1750 RPM
	6	Speed 3	0 RPM
	7	Speed 4	0 RPM
	8	Speed 5	0 RPM
Service	16	P1 Input	Speed 1 / Hold
	17	P2 Input	Not Used
	18	P3 Input	Not Used
	19	P4 Input	Not Used
	20	P5 Input	Upper Limit Switch

2 Step / Infinitely Variable

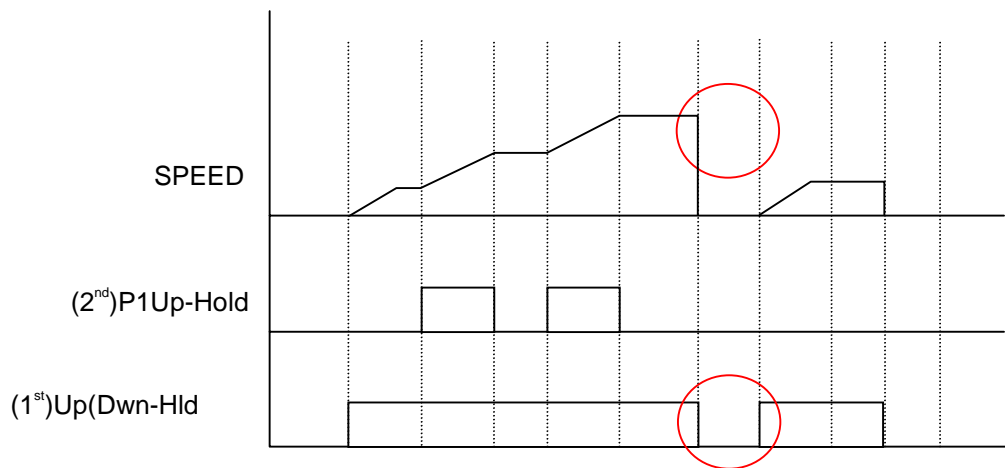

• 3 Step

Access Level	Code No.	Description	Initial Data
User	4	Speed 1	180 RPM
	5	Speed 2	900 RPM
	6	Speed 3	1750 RPM
	7	Speed 4	0 RPM
	8	Speed 5	0 RPM
Service	16	P1 Input	Speed 1
	17	P2 Input	Speed 2
	18	P3 Input	Not Used
	19	P4 Input	Not Used

• 3 Step / Infinitely Variable

Access Level	Code No.	Description	Initial Data
User	4	Speed 1	180 RPM
	5	Speed 2	900 RPM
	6	Speed 3	1750 RPM
	7	Speed 4	0 RPM
	8	Speed 5	0 RPM
Service	16	P1 Input	Speed 1
	17	P2 Input	Speed 2 / Hold
	18	P3 Input	Not Used
	19	P4 Input	Not Used
	20	P5 Input	Upper Limit Switch

3 Step / Infinitely Variable

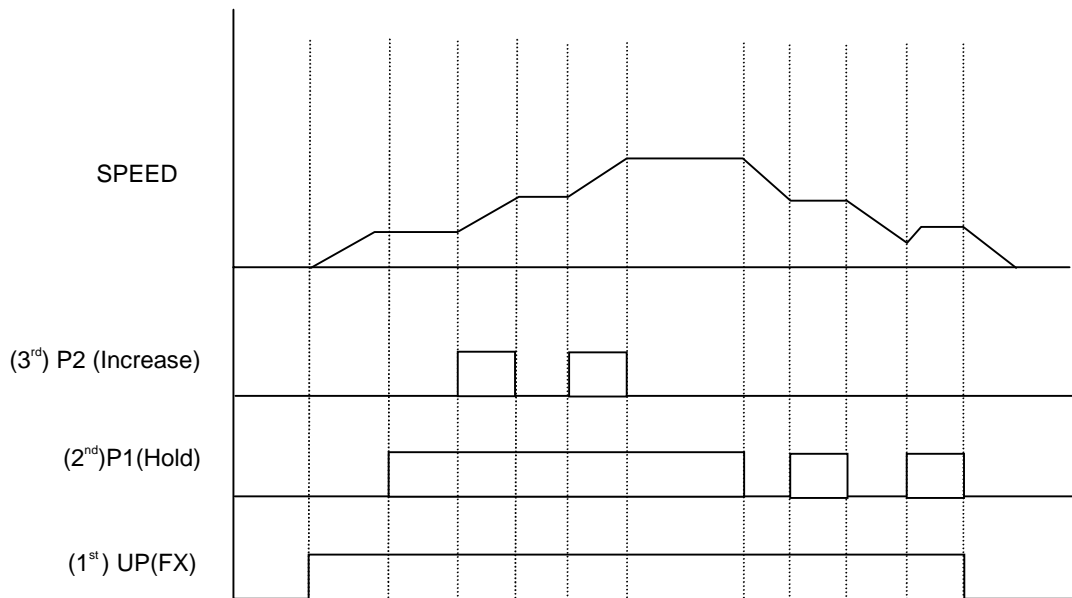

• 5 Step

Access Level	Code No.	Description	Initial Data
User	4	Speed 1	180 RPM
	5	Speed 2	450 RPM
	6	Speed 3	900 RPM
	7	Speed 4	1350 RPM
	8	Speed 5	1750 RPM
Service	16	P1 Input	Speed 1
	17	P2 Input	Speed 2
	18	P3 Input	Speed 3
	19	P4 Input	Speed 4
	20	P5 Input	Upper Limit Switch

- The five speeds can be changed individually in the **User Level** if so desired.

* Your Drive is now ready to run.

Drive Operation Checks

- Test with unloaded hoist.
- Make sure the hoist electric motor brake is operating properly.
- Run the hoist or traverse, and verify its correct operation in relation to direction of movement versus pendant button pressed.
- If you notice incorrect operational characteristics of the drive, please follow the troubleshooting chart in Section 4 of this manual, or contact your SpaceVector™ Dealer for further assistance.



WARNING

Never turn off the power to the drive unless the load is on the ground

Section 3: Programming

Passwords and Group Access Levels

Entering a Password

Back Door

Changing a Password

Programming Function Data

Passwords and Group Access Levels

The SFV1000 allows you to program up to two passwords. The purpose of a password is to prevent unwarranted people from inadvertently changing important parameters found in the **Service and Advanced Levels**. In order to change parameters in the **Service or Advanced Levels**, you must first enter a password designated to the respective level. The **User Level** does not require a password to change parameters.

When you first receive your drive, the programming permission level is initially setup for the **Advanced Level**. This means you can program any parameter in all levels. The initial password for all levels is (0). To help explain how passwords affect programming permission levels, see Figure 14 on page 50.

Entering a Password

When you first receive the SFV1000 drive, the initial password for all levels is (0). To help explain how specific passwords affect each permission level of programming in Figure 14 below, we will assume the initial password of (0) has been changed to a (1) for **Service Level** and a (2) for **Advanced Level**. If you wish to change passwords, see the Changing a Password section on page 52 of this manual.

Fig. 14 – Flowchart explanation for entering a password and its affect on programming permissions.

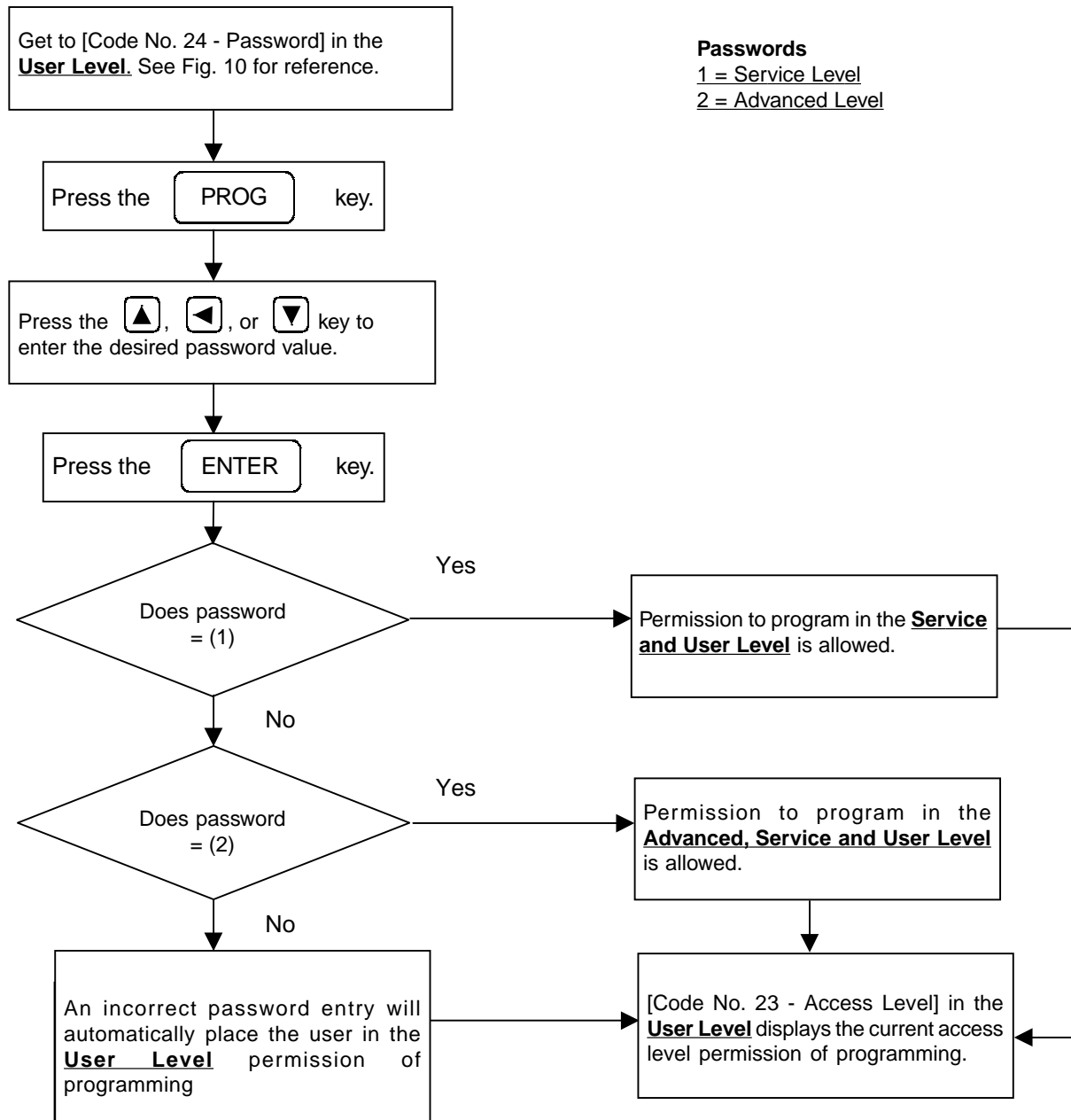

Backdoor

If user knows Advanced Password, user can identify Service Password.

Fig. 15 – Flowchart describing how to find out forgotten **Service Level** password.

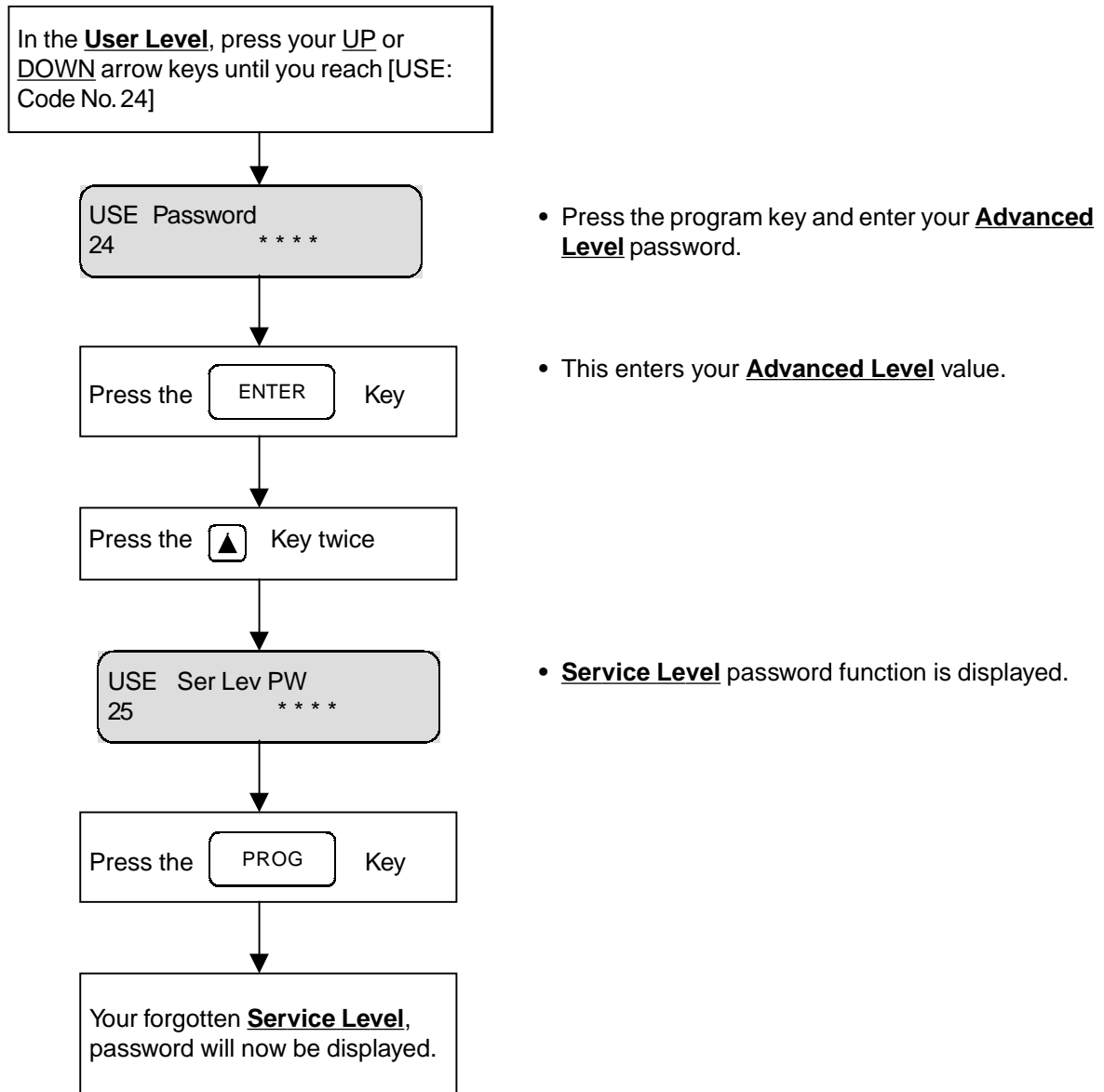

Changing a Password

If you wish to change a password in either the **Service Level** or the **Advanced Level**, refer to Figure 16 below. Caution: Once you change your password, make sure it is written down where it can be referenced at a later time if necessary.

Fig. 16 – Flowcharts showing how to change a password in the **Service and Advanced Levels**.

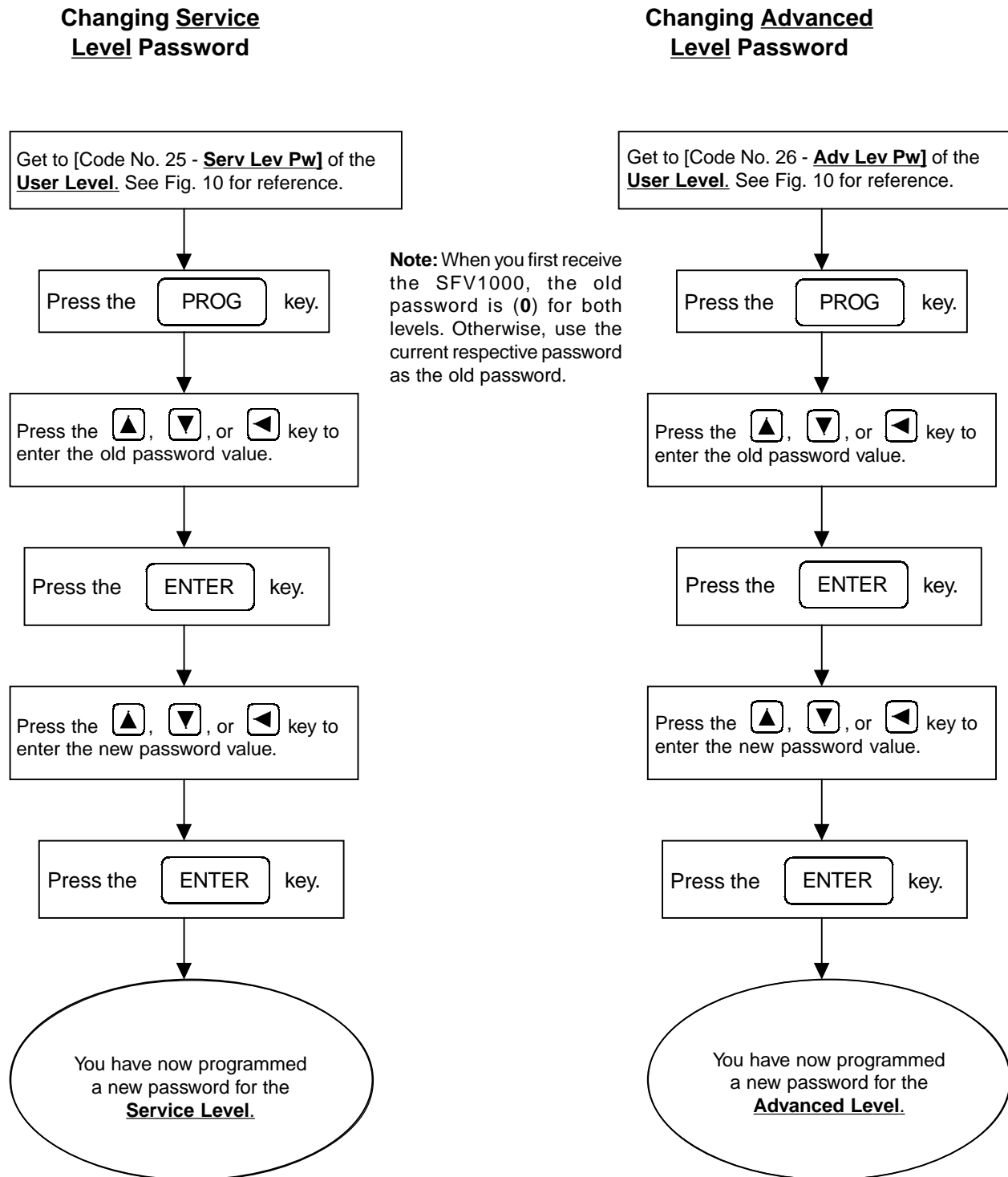

Programming Function Data

A password is required for changing any function data in the **Service** or **Advanced Levels**. Changing data in the **User Level** does not require a password. Changing function data requires a few short steps. Figure 17 gives an example of how to change function data. This programming procedure applies to all other parameters.

Fig. 17 – Programming Speed 2 Motor Speed from 1000 RPM to 1750 RPM

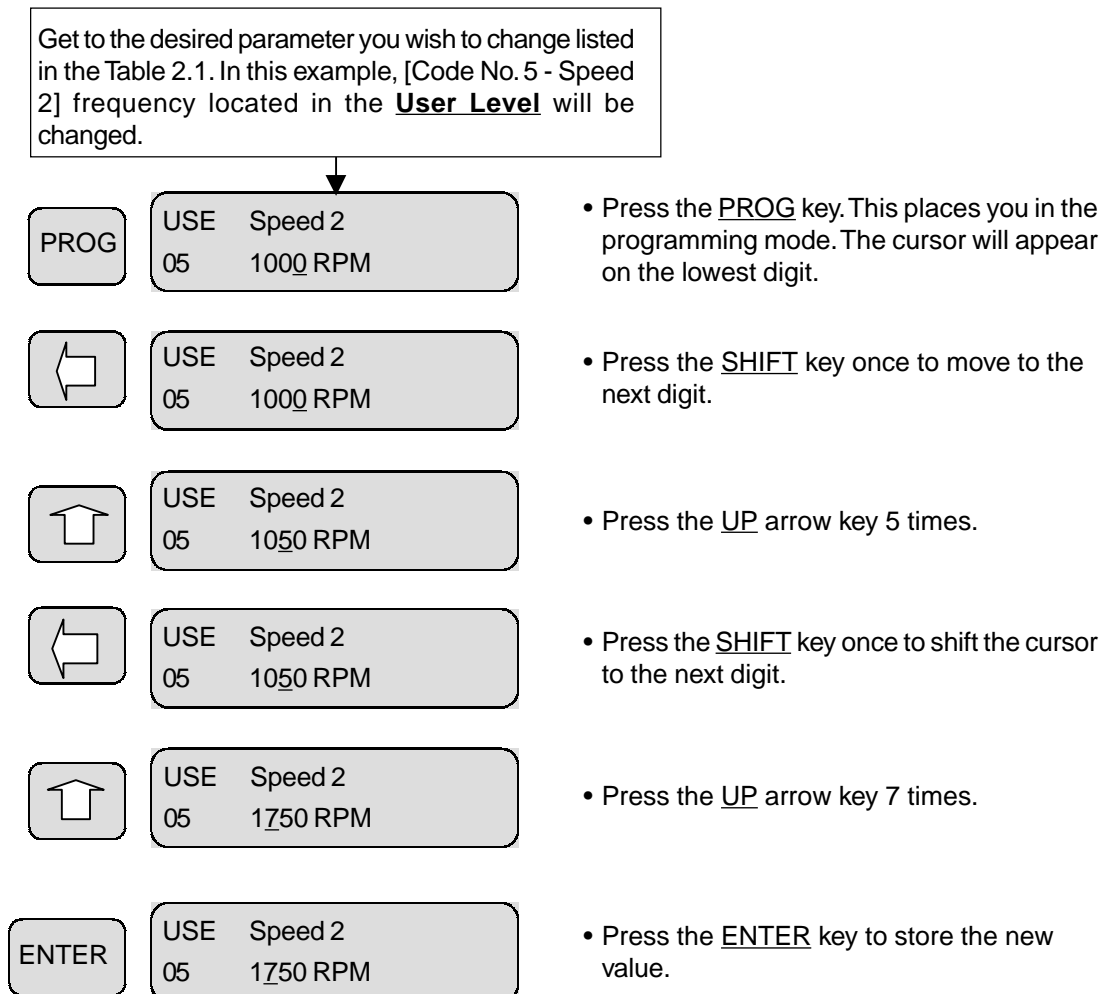

- In this example, lowering the drive RPM will lower the top speed of the motor.

Section 4: Trouble Shooting

Fault Trip Descriptions and Reasons for Faults

Monitoring Fault Trips

Trouble Shooting Flowcharts

Trouble Shooting Procedures

1. Drive does not run
2. Motor does not rotate
3. Motor rotates but speed does not increase
4. Motor rotates with correct speed but rotates in reverse direction
5. The motor rotational direction does not change
6. Neither Keypad nor Pendant operate correctly
7. Motor speed was initially correct, but soon heats up, hunts, or fluctuates in its speed
8. There is nothing displayed on the keypad
9. Motor runs, but the motor speed vibrates or fluctuates
10. The drive does not remember recently changed parameter values
11. Fuse Open Fault occurs periodically
12. Motor input current is too high
13. Frequent 'OC Trip' during RUN (Severe motor current fluctuation)
14. The Green LED on the REV, FWD or STOP key constantly Blinks

Pushbutton Pendant Test

Multi-function and Analog Output Test

Fault Trip Descriptions and Reasons for Faults

When a Fault Trip occurs, the inverter cuts off its output and displays the fault status in [Code No. 20 – Fault] of the **User Level**. The last two faults are saved in [Code No. 21 – Last Fault 1] and [Code No. 22 – Last Fault 2].

Table 4.1 - Fault Trip Descriptions

Faults	Display	Description
Overcurrent	OC Trip	Over Current output to motor is detected
Over Voltage	OV Trip	DC Bus voltage was higher than 400Vdc for 230Vdc Drive and 800Vdc for 460V Drive
Low Voltage	LV Trip	DC Bus voltage was lower than 200Vdc for 230V Drive and 400Vdc for 460V Drive
Inverter Overheat	IOH Trip	Temperature of inverter heatsink was higher than 85°C
Inverter NTC Open	ITH Trip	NTC of heatsink for checking the temperature is cut off
Motor Overheat	MOH Trip	Temperature of motor was higher than 150°C
Motor NTC Open	MTH Trip	NTC of motor for checking the temperature is cut off This fault will occur when thermistor is less than -10°C
Over Speed	Over Speed	The speed of motor was higher than 120% of max speed
External Trip	EXT Trip	Inverter was tripped by external fault signal
DC Bus Fuse Open	Fuse Open	Fuse of DC Bus was blown by overcurrent
Brake Fault	Brf	Brake Failure
Brake Release Fault	Brake Release Fail	Brake Release Failure
Output Phase Loss	Phase Loss	One or more Outputs to the inverter are opened
Speed Control Error	Spd Ctrl Fail	Speed Control Error

Monitoring Fault Trips

Checking the Current Status and History of Fault

The user can check the current status of the inverter and two previous faults that may have occurred.

Code	Display	Description
USE_20	No faults	Current status of inverter "No fault" is displayed in normal status
USE_21	P1 fault	The latest occurred fault is displayed
USE_22	P2 fault	The previous fault to USE_21 is displayed

Information is stored when fault occurs

Six different types of information related to inverter and motor status are stored when fault occurs. They are **speed reference, motor speed, torque reference, phase current of motor (rms value), input terminal status and output terminal status**. The user can check this information in [USE : Code No. 20], [USE : Code No. 21] and [USE : Code No. 22] on the display mode. Figures 18 & 19 on page 60 describe how to view faults during normal situations and when there is a fault.

Fig. 18 - Flowchart Showing How to View Fault Status When Everything is Normal.

When the Current Status is Normal

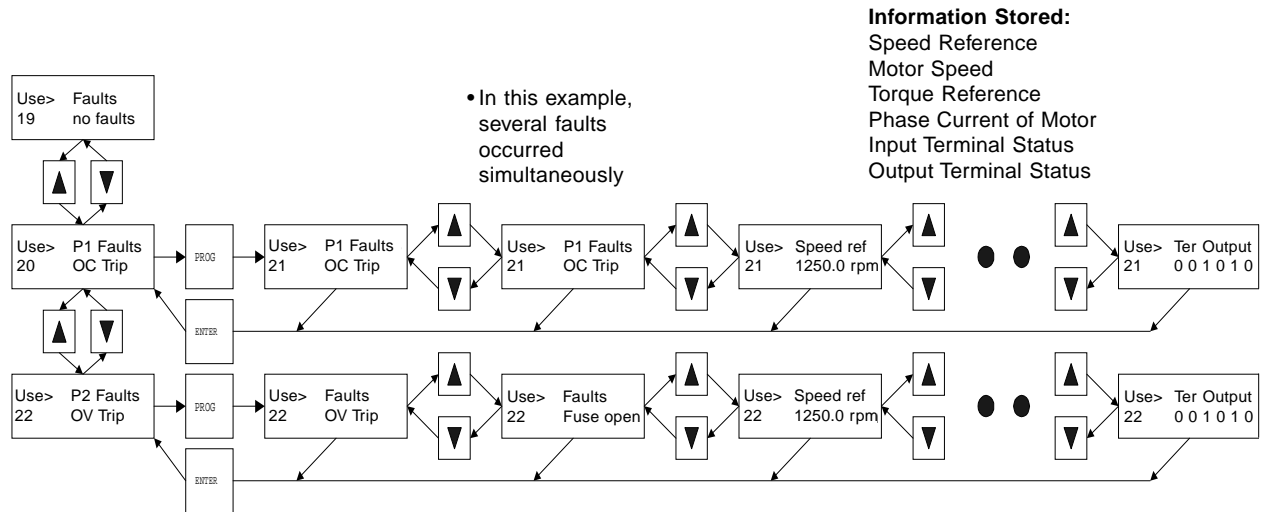
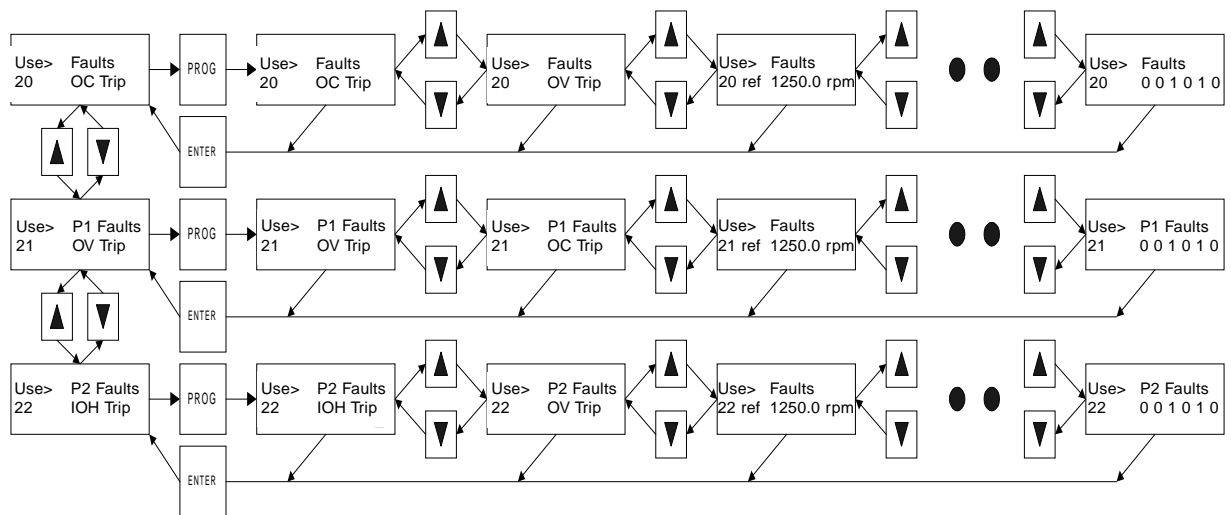

Fig. 19 - Flowchart Showing How to View Fault When a Fault Occurs.

When a Fault Occurs



Trouble Shooting Flowcharts

OV Trip

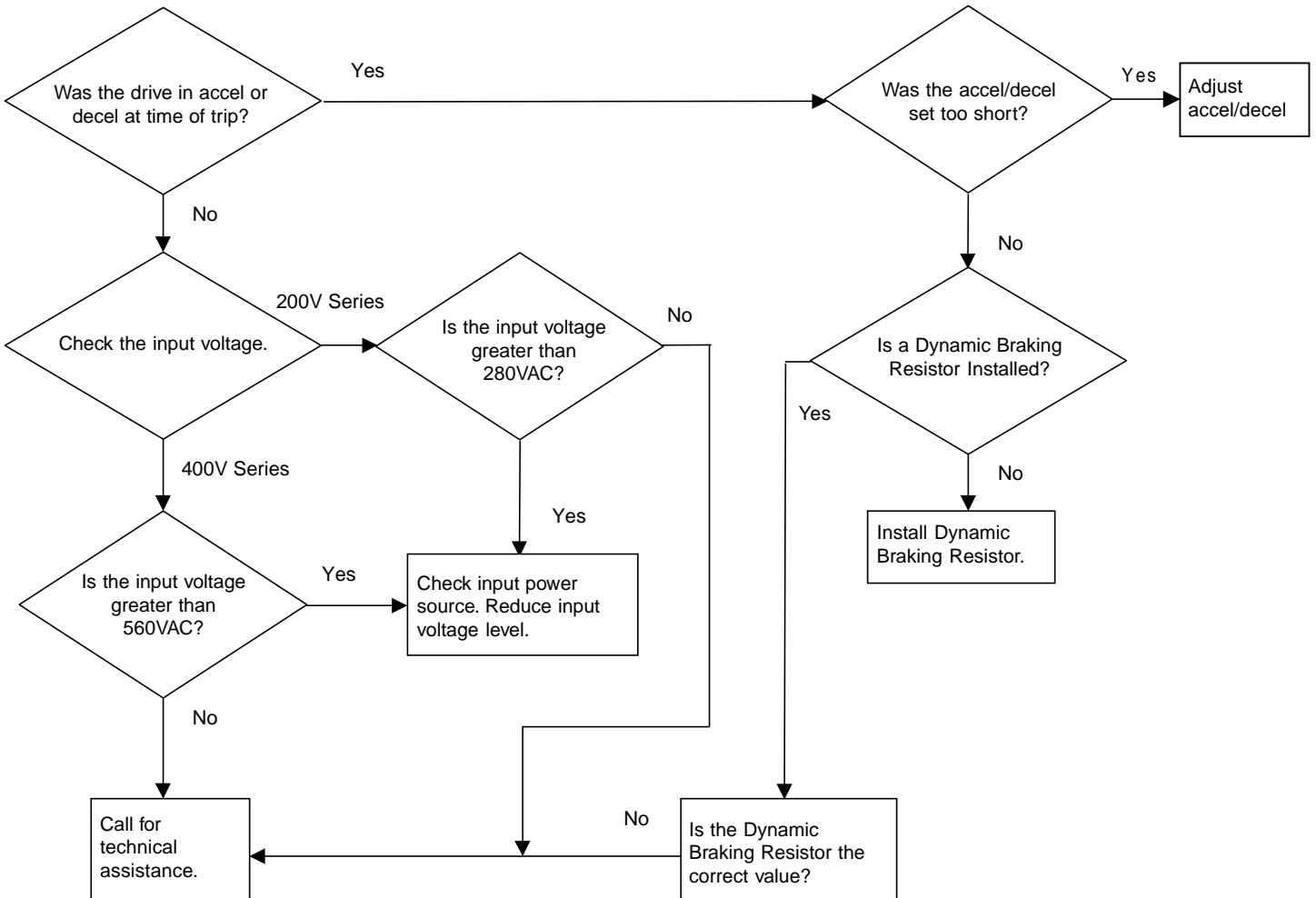

Low Voltage Trip

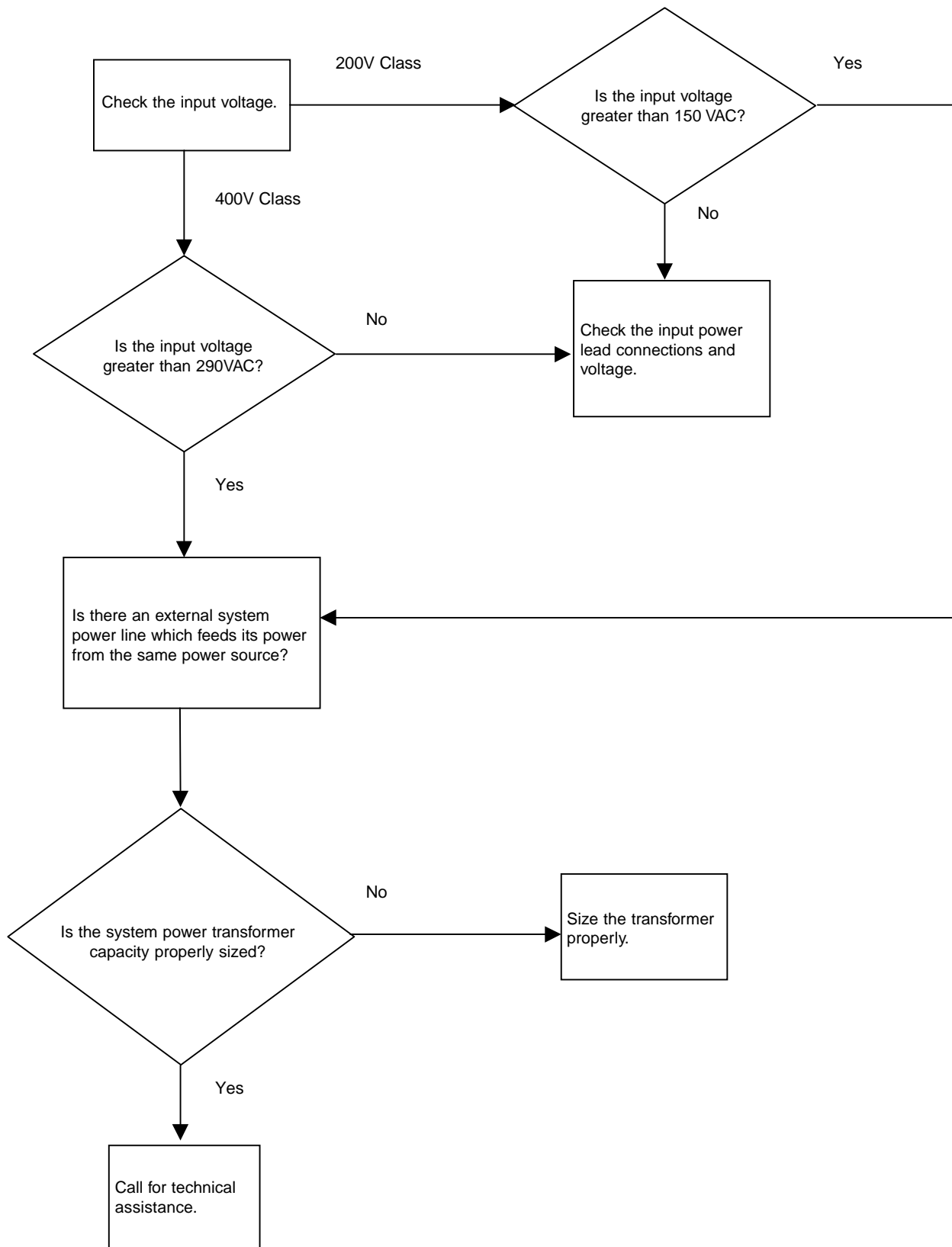

IOH Trip

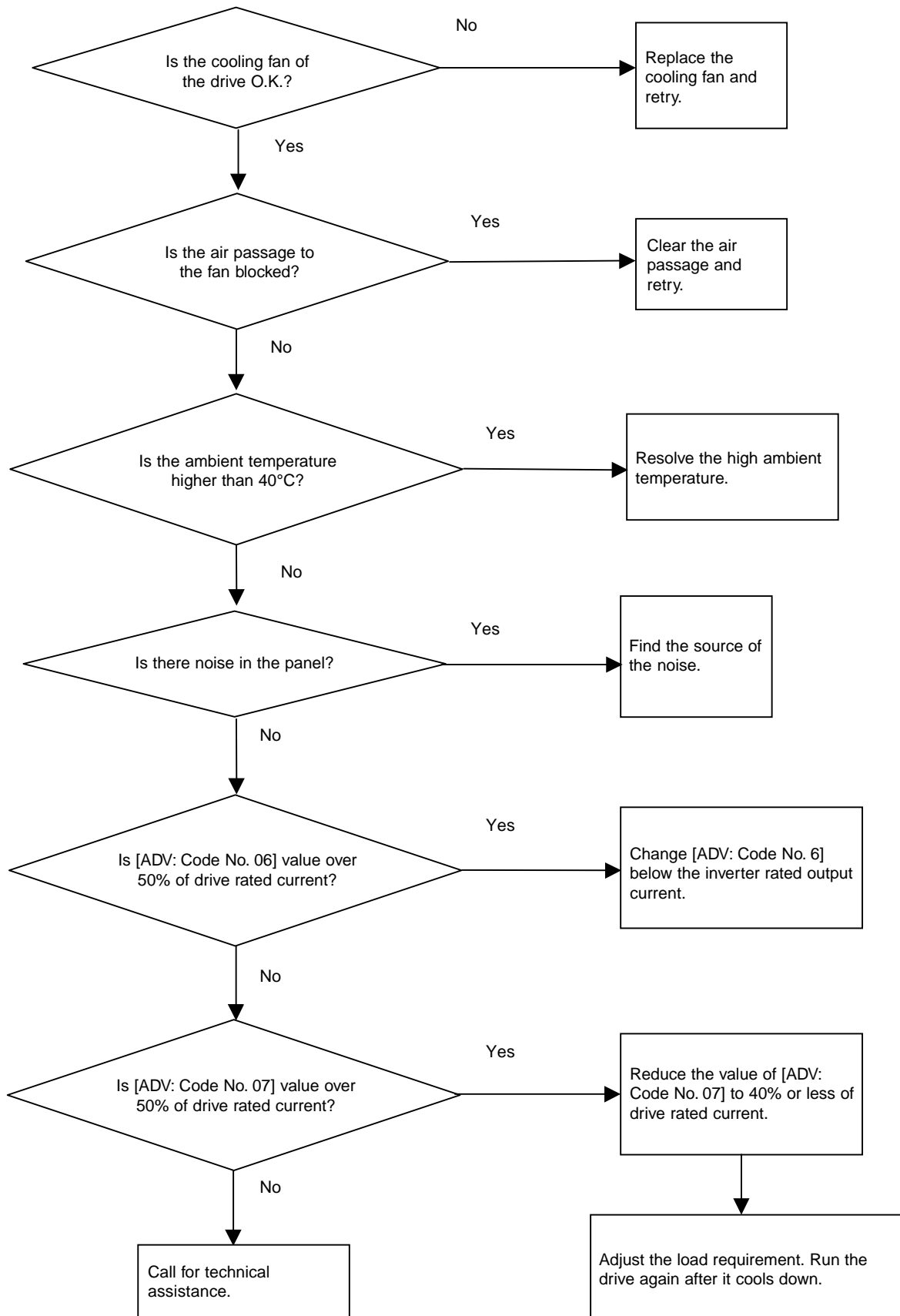

ITH Trip (NTC Problem)

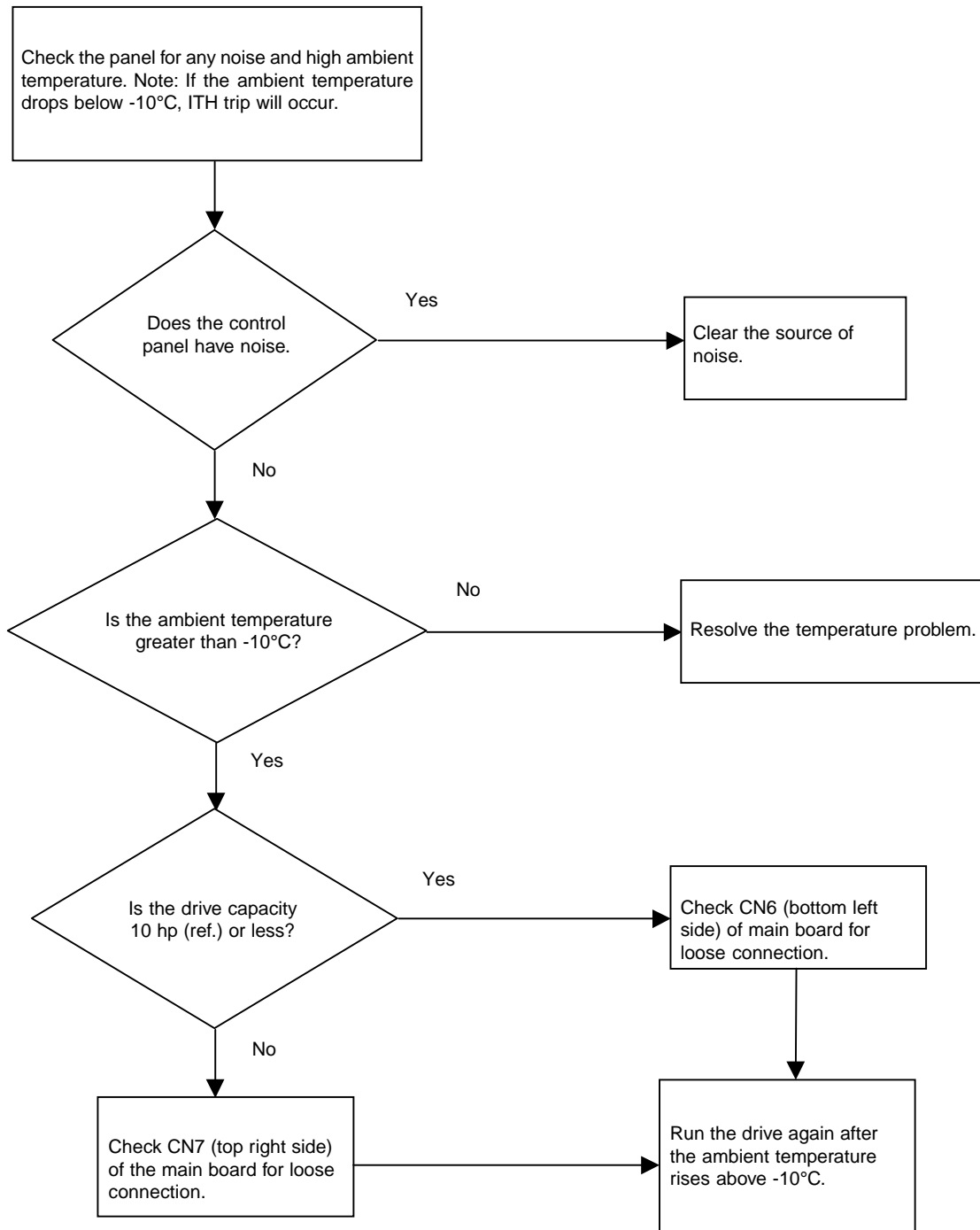

MOH Trip

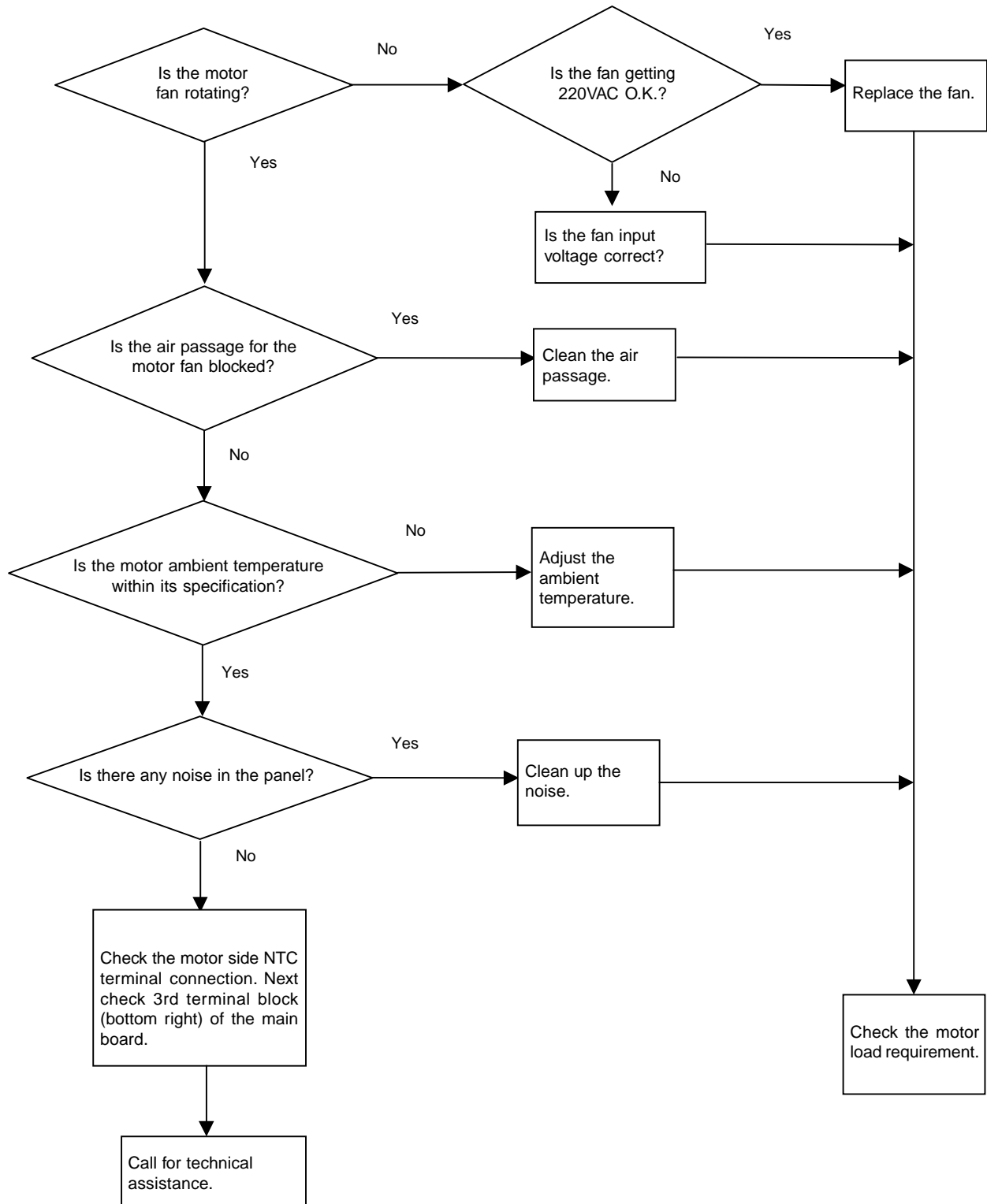

MTH Trip (Motor NTC Problem)

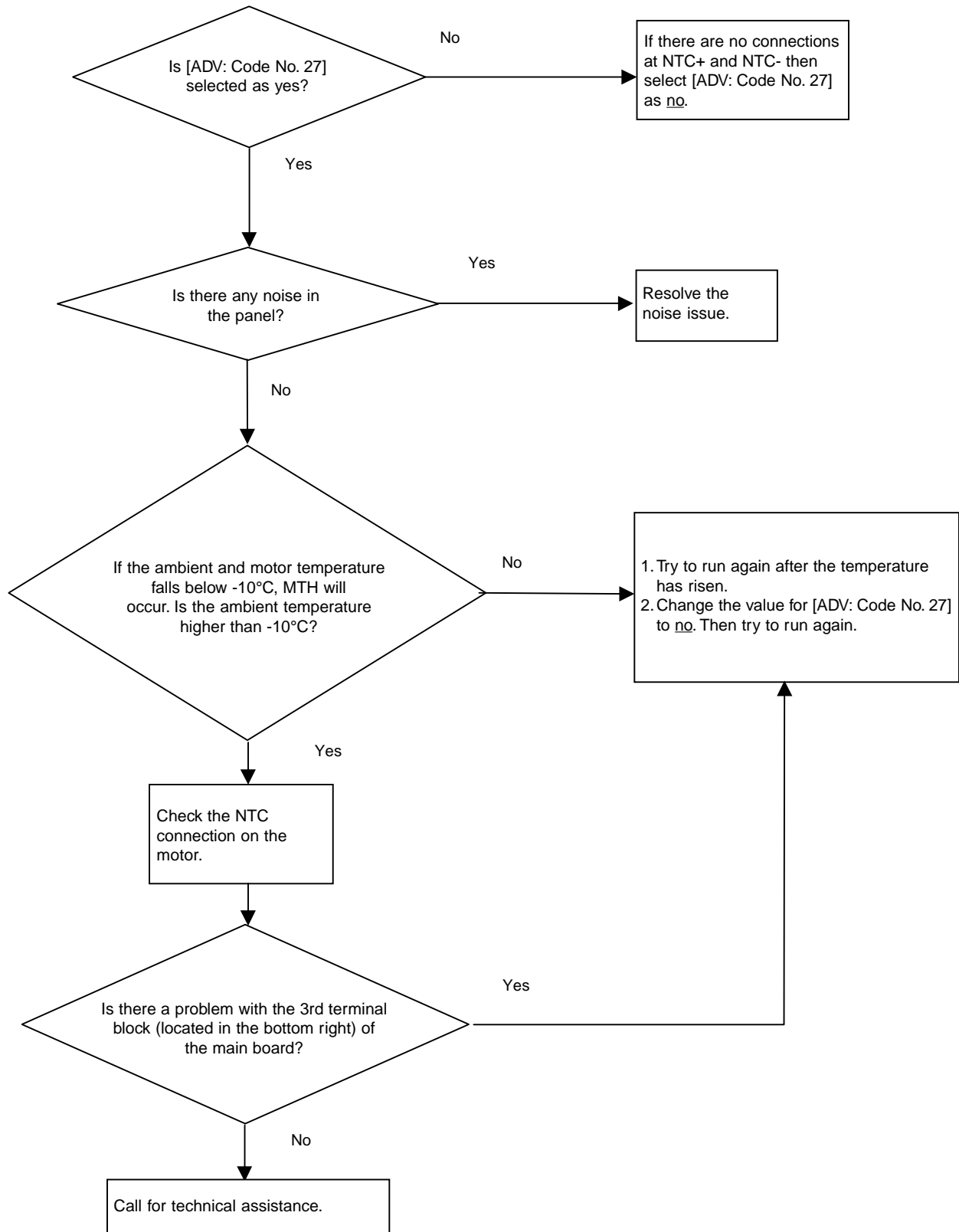

Trouble Shooting Procedure

Check below items before proceeding further

1. Have you checked the output lead connection from the drive to the motor?
2. Have you checked the Encoder Type Jumper on the main PCB of the drive for correct Encoder Selection (see page 24)?
If the Encoder type is **Complementary** or **Open Collector**, then Open the Jumper.
If the Encoder type is **Line Drive**, then Short the Jumper.
The factory default setting of the Jumper is **Open** (Complementary / Open Collector).
3. Is the motor rotational direction set correctly?
SFV1000 defines the motor rotation FORWARD if the motor rotation is in the clockwise direction looking at it from the Rear Bracket (Motor FAN) of the motor.
4. Were the drive and the motor tested in the No Load Condition?

Check Points at the time of the Initial Start Up

Please check items **(1) ~ (7)** if this is the first time experience on SFV1000 startup. If SFV1000 is being operated with a load and it has trouble operating normally, then go directly to items **(8) ~ (15)**.

(1) Drive Does Not Run. (Check if any of the LEDs on **REV**, **FWD**, **STOP** keys are turned on)

1. Is red STOP LED turned on?
 - ➔ Check **[USE: Function Code No. 20] (Fault Status)** to see if any fault has occurred. If fault has occurred, then press **RESET** key to reset the fault before trying to run again.
 - ➔ Check if the LCD is displaying **BX** (Emergency Stop). If so, check the Input Terminal Status on **[USE: Function Code No. 18]** to see if the **BX** terminal of the drive is actually receiving any signal. If Emergency Stop is activated, deactivate the **BX** signal before trying to run again.

USE<	Ter. Input
18	0010000000

2. Is **RUN/STOP** command method selected correctly?
 - ➔ Check **[SER: Function Code No. 01]** to see if the correct command method for RUN/STOP is set (Keypad or Pendant). If Pendant is selected correctly, but the drive still does not run, then change the method to KEYPAD and try to run using the drive KEYPAD. If the drive still does not run, then refer to item **(6)**.

(2) Motor Does Not Rotate. (Check if any LEDs on **REV**, **FWD**, **STOP** keys are turned on)

1. Is the drive output (U, V, W) correctly connected to the motor (U, V, W)?
2. Is the motor shaft being held by means of mechanical brake, electrical brake, or other mechanical systems?
 - ➔ Check the brake relay and brake release delay time. Also check the brake to see if the brake is releasing properly.

3. Is **[USE: Function Code No. 01] (Speed Reference)** set to '0Hz'?
 - ➔ If so, set the Speed Reference to a desired value other than '0Hz'. If the Speed Reference cannot be set, then refer to item (7).
4. Is **[SER: Function Code No. 34] (Inverter Capacity Selection)** set correctly?
 - ➔ Inverter Capacity is listed on the side label of the drive chassis and the cover.
5. Is **[SER: Function Code No. 35] (Motor Capacity Selection)** set correctly?
6. Is **[SER: Function Code No. 37] (Motor Rated Speed)** set correctly?
 - ➔ Refer to the name plate data of the motor.
7. Is **[ADV: Function Code No. 06] (Motor Rated Current)** set correctly?
 - ➔ Refer to the name plate data of the motor.
8. Is **[ADV: Function Code No. 07] (Motor No Load Current)** set correctly?
 - ➔ This value CANNOT exceed **[ADV: Function Code No. 06] (Motor Rated Current)**. Usually this value can be estimated to be 30~40% of the Motor Rated Current.
9. Is **[ADV: Function Code No. 09] (Motor Rated Slip)** set correctly?
 - ➔ Refer to the name plate data of the motor.
10. Is **[ADV: Function Code No. 12] (Rotor Time Constant)** set correctly?
 - ➔ This value must be set correctly. Otherwise, the performance of the drive can fluctuate dramatically.
11. Is **[ADV: Function Code No. 08] (Motor Pole)** set correctly?
 - ➔ Refer to the name plate data of the motor.
12. Is **[SER: Function Code No. 31-32] (Torque Limit)** set correctly?
 - ➔ [SER: Function Code No. 31-32] represent torque limit values. Depending on the application, this value can be adjusted to limit the amount of output torque. Keep in mind that SVF1000 torque specification is set at 150% continuous for 1 minute. Therefore, if this torque limit value must be increased above 150%, then continuous rated output time must be decreased in proportion.

(3) Motor Rotates but Speed Does Not Increase

1. Is **[SER: Function Code No. 38] (Encoder PPR)** set correctly?
 - ➔ The Factory Default Value for this is **1024**. Check your encoder and verify the number of pulses.
2. Set the **[SER: Function Code No. 01]** to Keypad, **[USE: Function Code No. 04]** to 100 rpm. Press **FWD** key, and observe the motor rotation. Does the motor rotate at 100 rpm? If not, check the encoder cable connection.
 - ➔ If any one of the encoder wires from the motor to the drive are open or reversed, then the motor will end up rotating at 30 ~ 60 rpm and will rotate only in one direction. Check to make sure that there are no open or reversed wires from the encoder to the drive.

3. If the motor rotation speed still does not increase above 30 ~ 60 rpm, then stop the motor and switch encoder cable A with B. Run the motor and check the direction of the motor. If the motor rotation has been reversed, then refer to **(4)**.
 - ➔ If you are using Line Drive Type Encoder, switch A+ and A- with B+ and B- respectively. If you are using Complementary / Open Collector Encoder, switch PA with PB.

(4) Motor rotates with correct speed but rotates in reverse direction.

- ➔ Switch Phase V lead with W lead of the drive output. At the same time, reverse encoder cable A with B just as indicated in **(3)**.

(5) The motor rotational direction does not change.

1. Is RUN/STOP reference source set correctly?
 - ➔ Check **[SER Function Code No. 01] (RUN/STOP Source)** to see if the value is selected correctly per application (Keypad or Pendant). If it is set to Pendant and the drive is supposed to be controlled by the external pendant, then check for the correct pendant wire connection to 120V Interface Card of the drive. If the drive still does not operate correctly, then change this value to Keypad and run the motor from the keypad. If it still does not work, then refer to **(6)**.

(6) Neither Keypad nor Pendant operate correctly.

1. In the case of ANY LED on **REV**, **FWD**, or **STOP** key is ON.
 - ➔ Refer to **(1)** if RUN/STOP cannot be controlled by the keypad or the pendant. If the program cannot be accessed (cannot change the value), then check the triangle on the LCD display of the keypad (it is located in the lower left corner of the display). If this triangle is not filled up with a black color or the inside of it is empty, then the parameters are LOCKED. If this is the case, then set program **[SER: Function Code No. 47] (Parameter Lock)** to the UNLOCK code number. Call the SpaceVector help desk (toll free) 877 226-6278 for the UNLOCK code number. This will UNLOCK the parameters. If the parameters still cannot be changed, then call your CraneSource Dealer for further assistance.
2. In the case of a blinking RED LED on **REV**, **FWD**, or **STOP** key.
 - ➔ This indicates a fault condition exists currently or BX (Emergency Stop) is activated. Check **[USE: Function Code No. 20] (Fault Status)** for fault existence. If BX has been activated, deactivate BX, then try to run again (This can be verified by monitoring the keypad display. For BX, the lower level of LCD display will show BX).
3. In the case of a blinking GREEN LED on **REV**, **FWD**, or **STOP** key.
 - ➔ In this case, the drive is either in the process of acceleration or deceleration. If the motor tends to rotate continuously in this condition, then this indicates that the motor is overloaded and the drive cannot bring the motor speed to the desired speed point.

(7) Motor speed was initially correct, but the speed begins to fluctuate.

1. Check the motor wiring connection.
 - ➔ If the motor is rated for both 230V and 460V, motor winding connection could be miss-wired. If the motor pole # is set incorrectly in the drive, then the motor will not be able to turn smoothly. However, if the motor winding connection was miss-wired and the motor has been operating for a long period, then the motor could have been damaged. In this case, call your motor manufacturer for further instruction.
2. Is the Drive and Motor Capacity Selection set correctly?
 - ➔ Check **[SER: Function Code No. 34] (Drive Capacity Selection)** and compare it with the capacity rating listed on the side label of the drive.
 - ➔ Check **[SER: Function Code No. 35] (Motor Capacity Selection)** and compare it with the nameplate data of the motor.
3. Are all motor parameters programmed incorrectly?
 - ➔ Motors made by different manufacturers have different motor parameters from one to another. Refer to the motor manufacturer for further information.

(8) There is nothing displayed on the Keypad.

1. Is the keypad and drive connected correctly?
 - ➔ Check the ribbon cable connectors to make sure they are tight. Also, make sure that the latch is locked all the way.
2. Is Input Voltage to the drive correct?
 - ➔ Check if the drive Power PCB is charged and powered up. This can be done by observing 'CRG' lamp located in the top right hand corner of the drive (3hp 230/460V - 10hp 230/460V) or 'LED1' lamp on the bottom left hand corner of the drive (15hp 230/460V - 30hp 230/460V). If the drive is powered up and no problem is found with ribbon cable connectors, then call your CraneSource Dealer for further assistance.

(9) Motor runs, but the motor speed vibrates or fluctuates.

1. Is the encoder cable made of Twisted Pair Shielded Cable?
 - ➔ If not, then there can be noise from the encoder input causing a misinterpretation leading to an incorrect speed feedback reading by the drive. This will result in motor speed fluctuation. This also can cause shaft vibration when the motor comes to a stop.
2. Is the encoder cable connected tightly to the drive and the encoder?
 - ➔ Check the encoder cable connection. If the drive and the encoder connection is not made properly, then the effect could be severe. The encoder cable terminals at the drive side are located on the bottom right hand corner of the control PCB. Try to reconnect the cable wires again to these terminals, and tighten the screws to make sure there are no loose wires. Also, check the COMMON EARTH GROUND between the drive and the motor. For example, connect the ground cable between the motor earth point to the drive's 'E' terminal.
3. Connect the Earth Ground point of the panel to the drive's 'E' terminal (the motor ground cable is connected to this terminal as well). Make sure this panel ground is connected to a TRUE GROUND SOURCE of the building.
 - ➔ Incorrect panel ground can cause encoder cable noise resulting in motor speed fluctuation.

4. Check if the PI Gain for the drive output speed is too high?
 - ➔ IF **[SER: Function Code No. 28 & 29]** (PI Gain) are set too high compared to the actual motor load, then the motor will vibrate when it comes to a stop. Therefore, these values must be set properly for smooth motor speed control at any level. **Note:** the Higher the P-Gain value is and the lower the I-Gain value is set, the motor speed response time will be shortened. However, this can result in an unstable system. The values for these gains will be different for every system. Generally, a P-Gain value between 30% to 70% is proper; and an I-Gain value between 100 ~ 500ms is acceptable.
5. For **[SER: Function Code No. 39]** (ENC LPF), program its data for about 30 msec.
6. Check if there exists any slip between the motor shaft and the encoder.

(10) The drive does not remember recently changed parameter values.

- ➔ After changing the drive parameters, if the drive power is shut off and turned on again and the drive does not recall the changed values, then call your CraneSource Dealer for further assistance.

(11) Fuse Open Fault occurs periodically.

1. Balanced 3 Phase Input Voltage to the drive must be checked.
 - ➔ Check for any missing phase and any voltage unbalance to the drive. If the phase to phase voltage unbalance is more than 2% (ex. For 460V input, more than 6V difference), then install AC REACTOR UNIT between the power source and the drive power input. With unbalanced voltage, not installing an AC Reactor can cause periodic 'Open Fuse' condition. This damage IS NOT COVERED under the warranty.
2. Have you checked Motor Leads for proper connections?
3. Has the motor insulation been properly checked?
 - ➔ In case of motor winding insulation damage, the motor can show many different abnormalities in its operation. Most of the time, the motor cannot achieve high speed range, or 'OC Trip' occurs. Often the motor heats up excessively with severe vibration. If the motor behaves as described above, then the insulation of the motor must be checked.

(12) Motor input current is to high.

1. Check the motor lead connections again.
2. Check the Drive Capacity Selection and the Motor Capacity Selection.

(13) Frequent 'OC Trip' during RUN (Severe motor current fluctuation)

1. Check the encoder mounting condition.
 - ➔ If the encoder mounting to the motor shaft is loose, then the encoder can shake as the motor rotates resulting in incorrect signal generation from the encoder. Vector drive calculates its output speed depending on the speed feedback it receives from the encoder. Therefore, incorrect signals can result in increased slip causing the drive output current to increase as well.
2. Check for the Open Phase to the motor.
3. Check the motor winding insulation.

(14) The Green LED on the **REV, **FWD**, or **STOP** key constantly BLINKS.** This indicates the drive is unable to achieve the set acceleration or deceleration (Cannot overcome the load).

1. Check **[USE: Function Code No. 9 - 10] (Acceleration time, Deceleration time)**.
 - ➔ Blinking green LED on the keypad keys indicates that the drive is in either acceleration or deceleration mode. If this blinking continues without reaching the speed reference, then this is indicating that the output torque of the drive is not enough for the load demand. For this, the torque limit must be increased, permitting the drive to achieve correct acceleration or deceleration within its rated current level.

Pushbutton Pendant Test

The condition of input terminals can be monitored by using the display. You must first go to [Code No. 18] in the **User Level**. Once you press the **PROG** key, the display becomes active. See Figure 20 below for testing procedure.

Fig. 20 – Testing procedure for pushbutton pendant test.

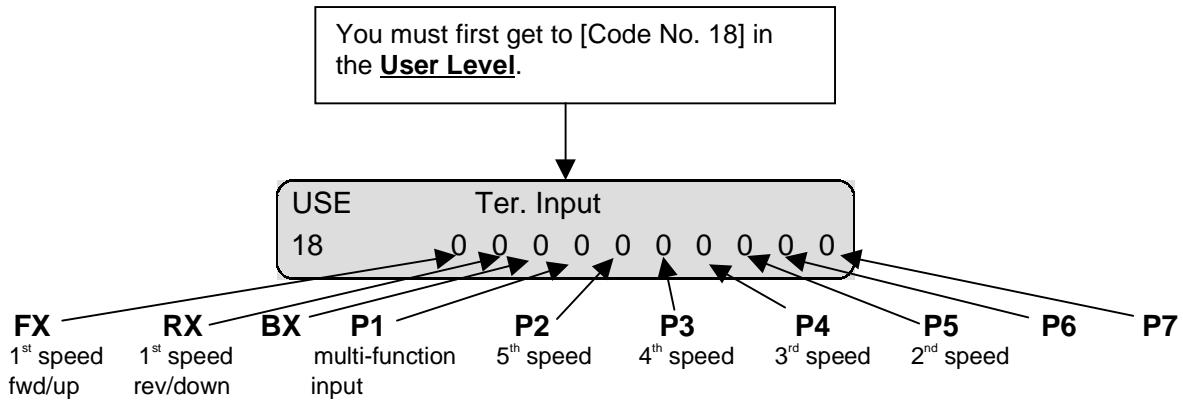

- This display shows status of 10 user inputs. 1 indicates that the corresponding input is on. 0 indicates that the corresponding input is off. Verify correct wiring if an input does not function properly.

Example

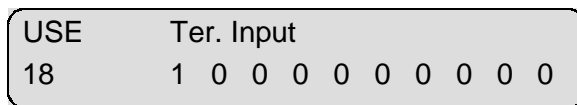

- The display in this example shows that the forward/up input [**FX**] on the pendant checked O.K.

Multi-function and Analog Output Test

The condition of the multifunction and analog outputs can be monitored by using the display. You must first go to [Code No. 19] in the **User Level**. Once you press the **PROG** key, the display becomes active. Reference Figure 21 below for testing procedure.

Fig. 21 – Testing procedure for pushbutton pendant test.

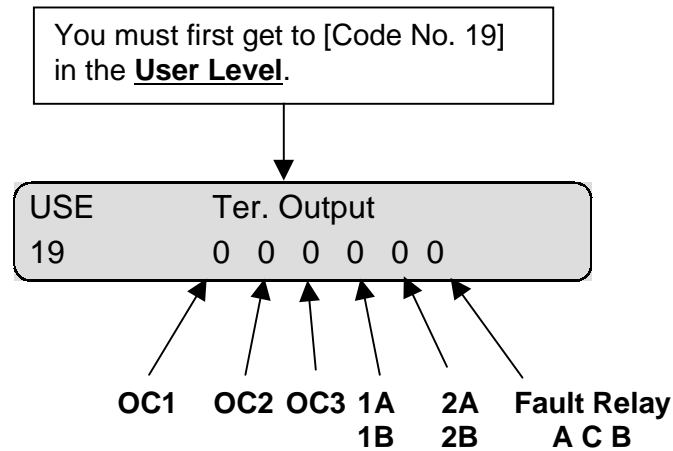

- Whenever an output is closed, a 1 will appear. If an output is open, a 0 will appear.

Example

USE	Ter. Output					
19	0	1	0	1	0	0

- The display in this example shows that **OC2** and **1A/1B** are currently closed.

Section 5: Features

Explanation of Features

True Braking Proving Sequence

Micro Positioning

Slack Cable Detection

Warp Speed

Keypad Jog Operation

Definition of Limit Switch Input

Explanation of Features

True Brake Proving Sequence Normal Start Up with Brake Proving

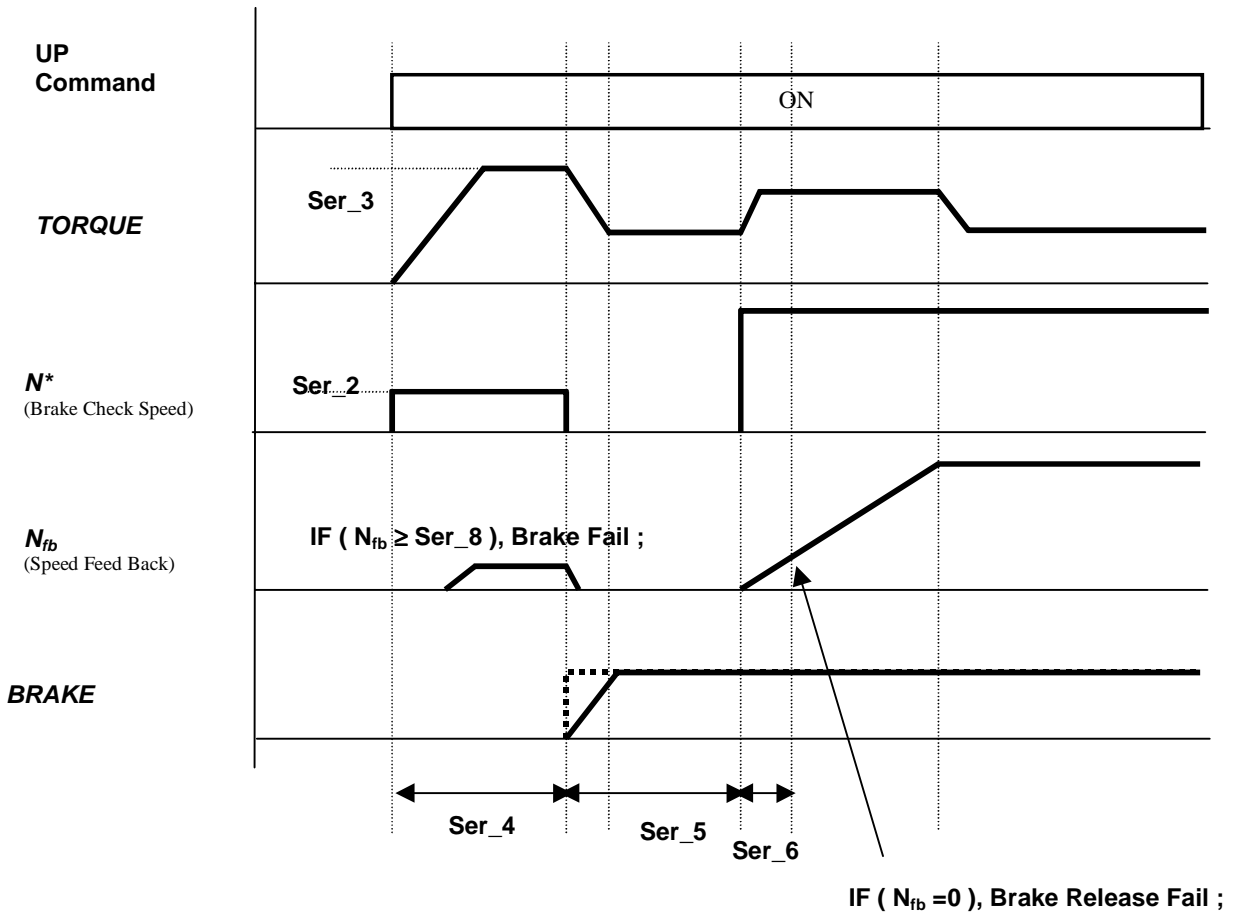

Normal Stop with Brake Proving

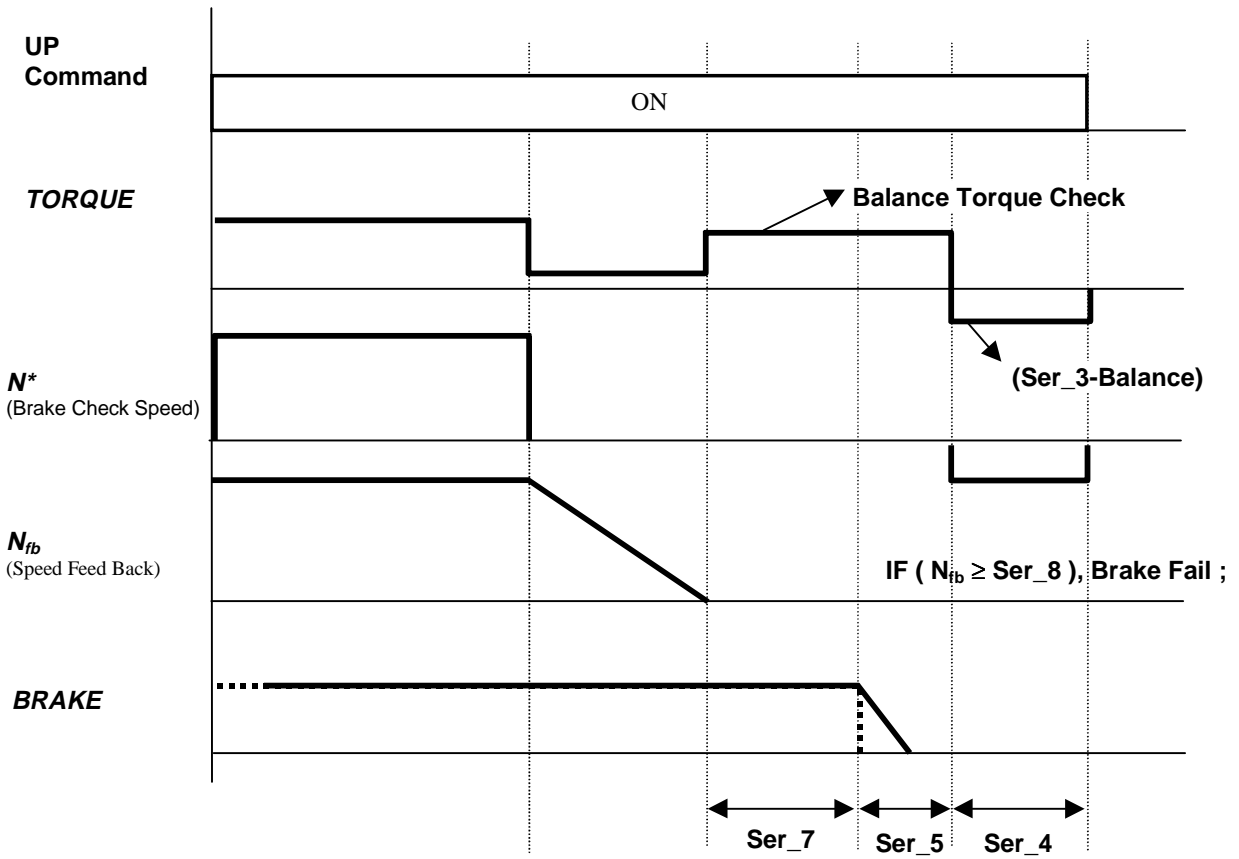

Start when Upper limit is input

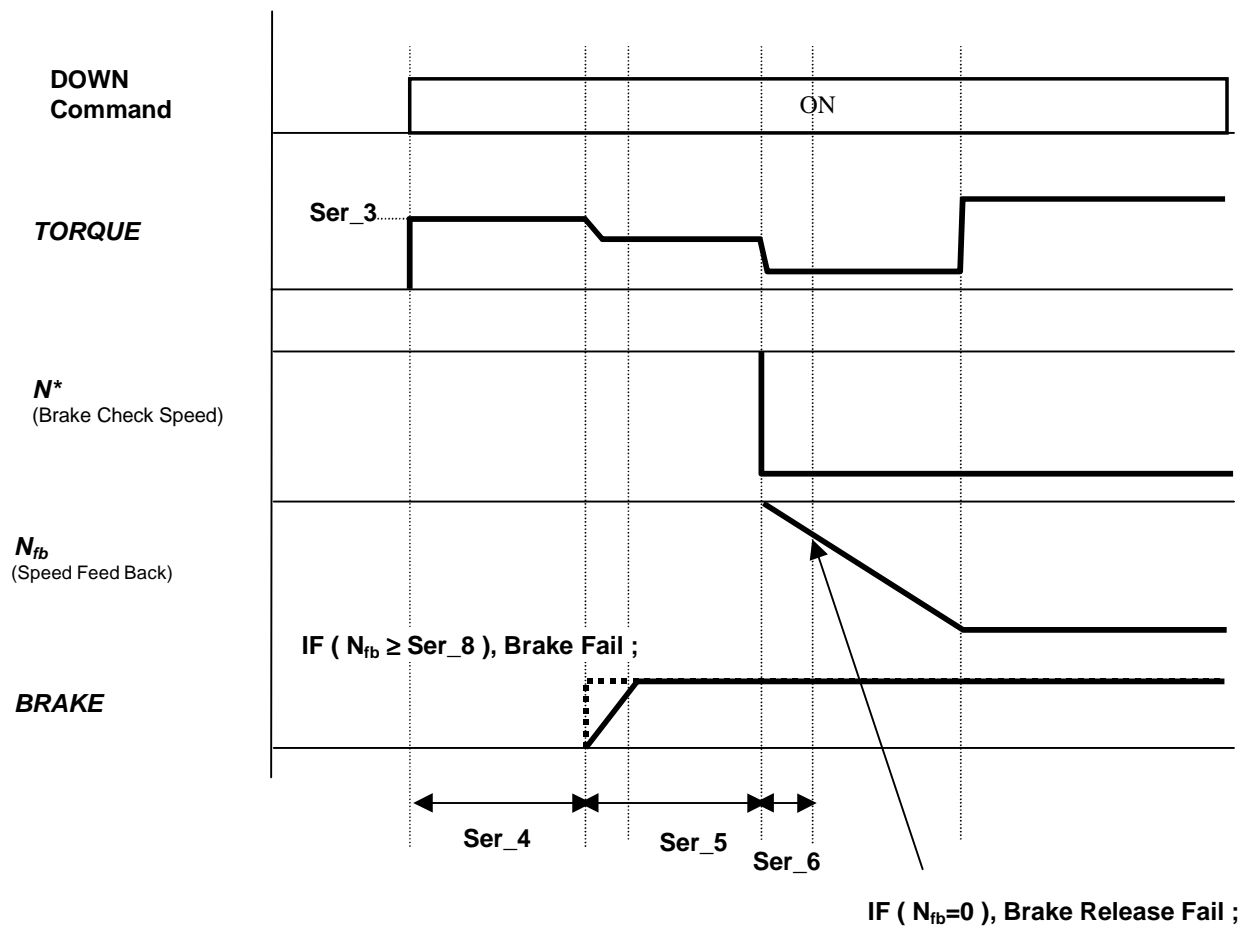

Related Brake Proving Function Codes

Function Code	Display	Description
Ser_20	P5 Input	Define Multi-funTION Input 5 (Upper Limit)
Ser_23	AX1 Output	Define Multi-funTION Input 1 (Brake Control)
Ser_24	AX2 Output	Define Multi-funTION Input 2 (Alarm Buzzer)
Ser_9	SEQ Band	Speed Deviation Error Detect Level
Ser_2	Br CHK Speed	Speed Reference for Brake Proving Sequence
Ser_3	Br CHK Bias	Torque Reference for Brake Proving Sequence
Ser_4	Br CHK Time	Interval for Braking Proving Sequence
Ser_5	Br MECH. Dly	Brake Mechanical Time Delay
Ser_6	Br Answer T	Time at which Brake Release is guaranteed
Ser_7	Float T	Interval for Floating Weight without Setting Brake
Ser_8	Br Err Speed	Speed feedback for Brake Failure Detection

When a Brake Failure is detected:

If speed feedback is detected when the motor stops, it means that the Brake does not operate properly and only the Drive is controlling the weight. This is a very dangerous situation. The SFV1000 detects the Brake Fault and controls the motor at zero speed, "floating Load". It sounds a Buzzer Alarm to notify responsible personnel of this situation. **Never turn off the power of the Drive unless the Load is on the ground.** After the alarm sounds you can still control the hoist as usual by using the Down button to lower the weight to the ground and then turn off the power.

Detecting Brake Failure and Floating Load

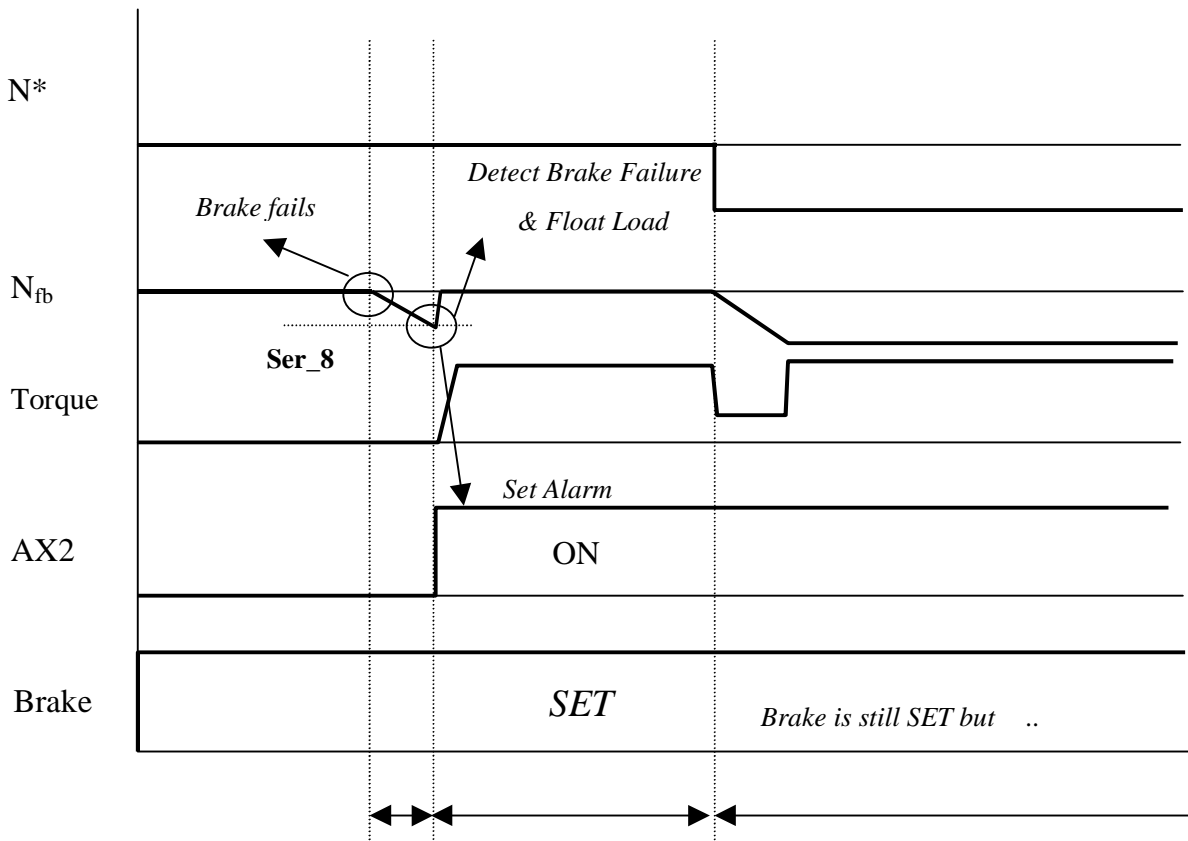

Lowering Load to the ground and Turning off Power of Drive

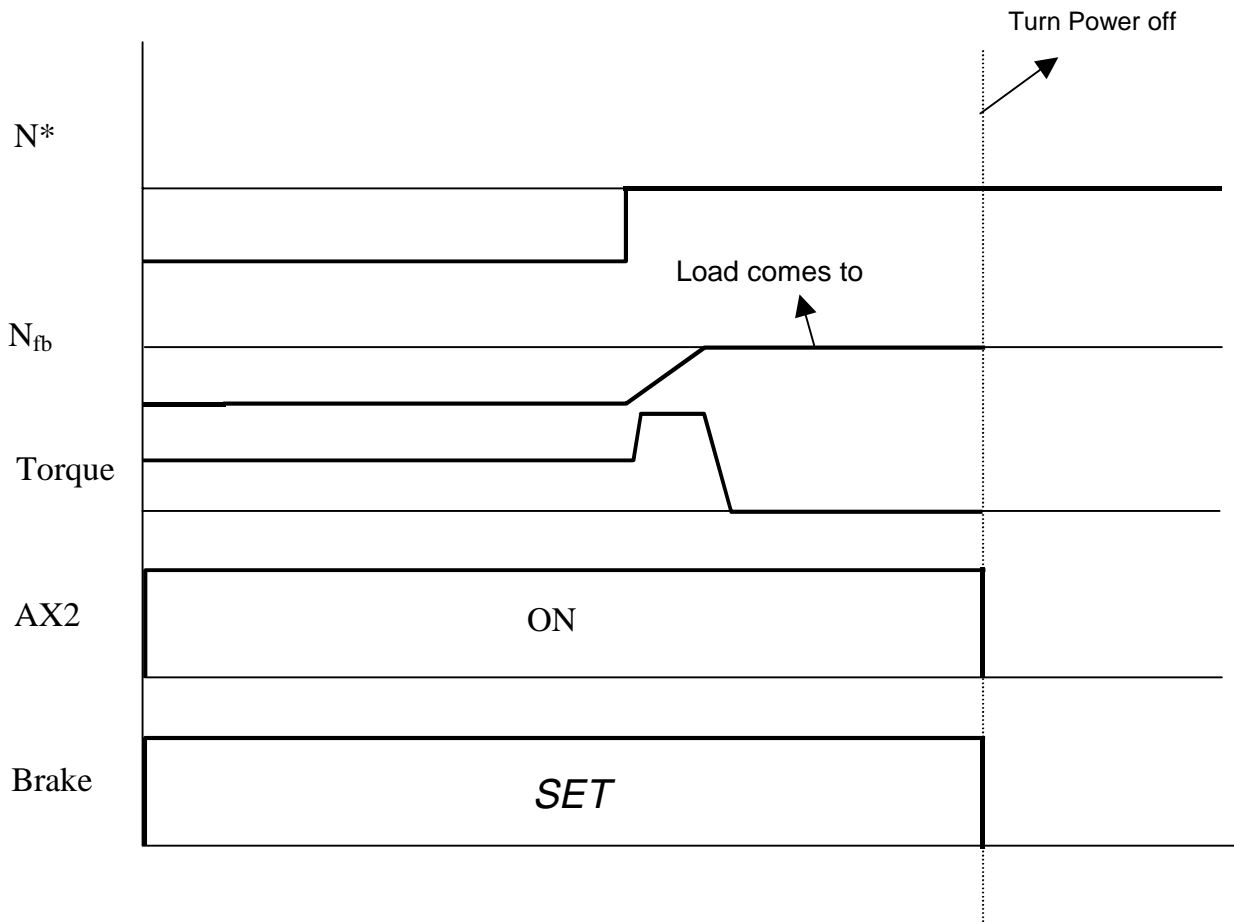

Speed Control Failure

When the motor speed deviates the reference speed over the amount of **[SER: Function Code No. 09]**, the SFV1000 sets the brake and cuts off the output. The keypad displays "Spd_Cntl_err".

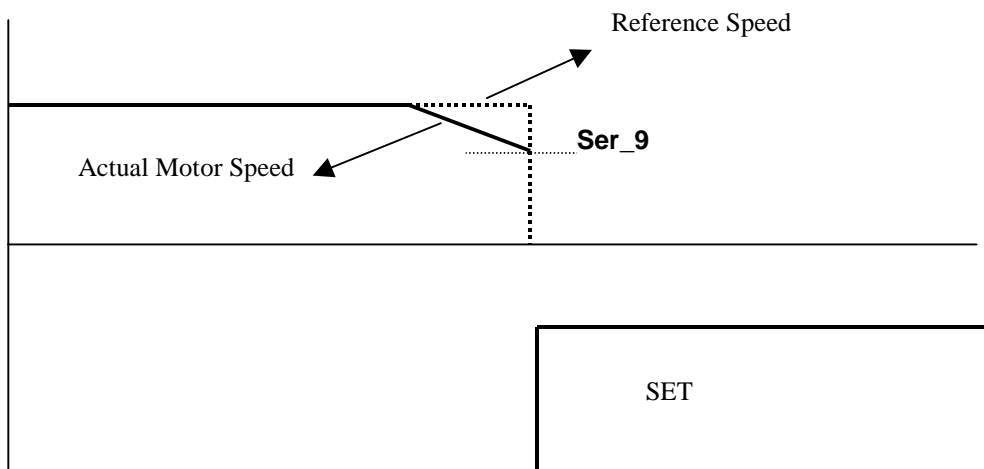

Micro Positioning

Related Function Codes

Code Number	Display	Setting
Ser_16	Multi-function Input	Mirco Pos
Ser_20	(P1 ~ P5)	
Adv_1	Micro Positioning Gain	0.1 ~ 100%

Micro Positioning offers precise hoisting. This function provides extremely low speed by use of Multi-function Input terminal. The Micro Positioning Speed is determined by Normal Speed multiplied by Micro Positioning Gain (Adv_1) . If P5(Ser_20) is selected as “Micro Pos” , the operation is as follows.

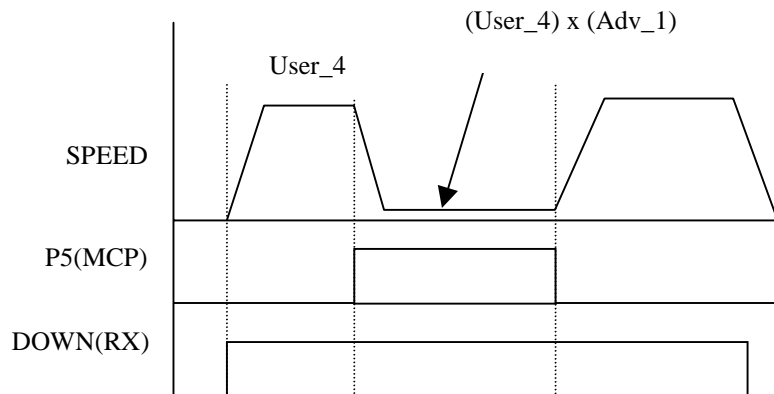

Slack Cable Detection

SFV1000 drives offer Slack Cable Detection. When there is slack in the rope, the SFV1000 stops the motor immediately. After detecting Slack Cable, Slack Speed (User_12) is applied in hoisting if DOWN motion is the input. UP command cancels Slack Cable Situation.

Related Function Codes

Code Number	Display	Setting
User_12	Slack Speed	0 ~ 500 RPM
Adv_2	Slack / Warp Selection	Slack
Adv_3	No Load Torque	0 ~ 100%

Slack Cable Diagram

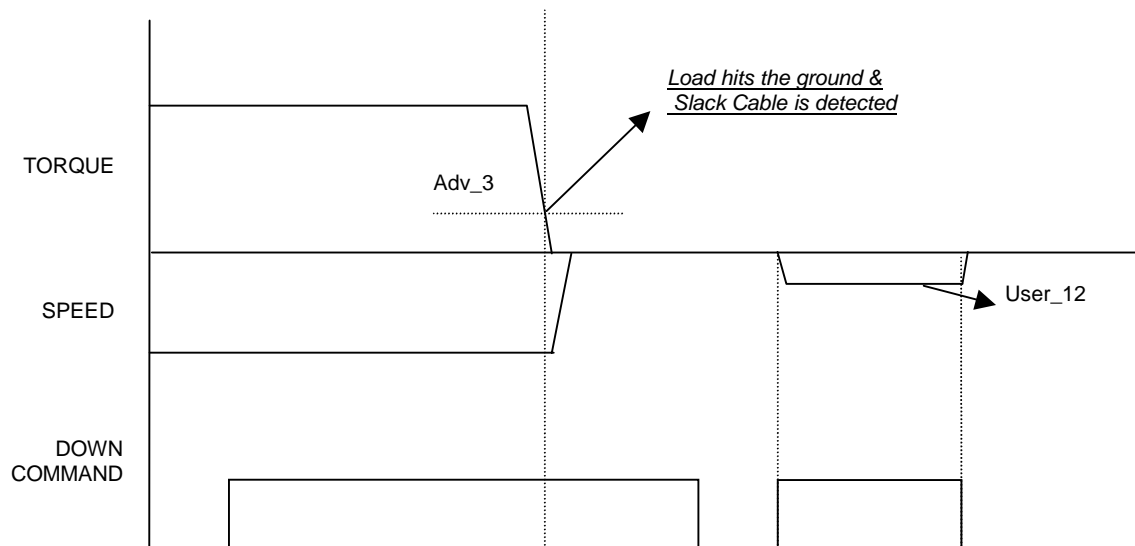

Warp Lift

When no weight is hooked up, the SFV1000 detects no load condition and increases hoisting speed automatically.

Related Function Codes

Code Number	Display	Setting
Adv_2	Slack/Warp Selection	Warp
Adv_3	No Load Torque	0 ~ 100%
Adv_4	Warp Gain	100 ~ 200%

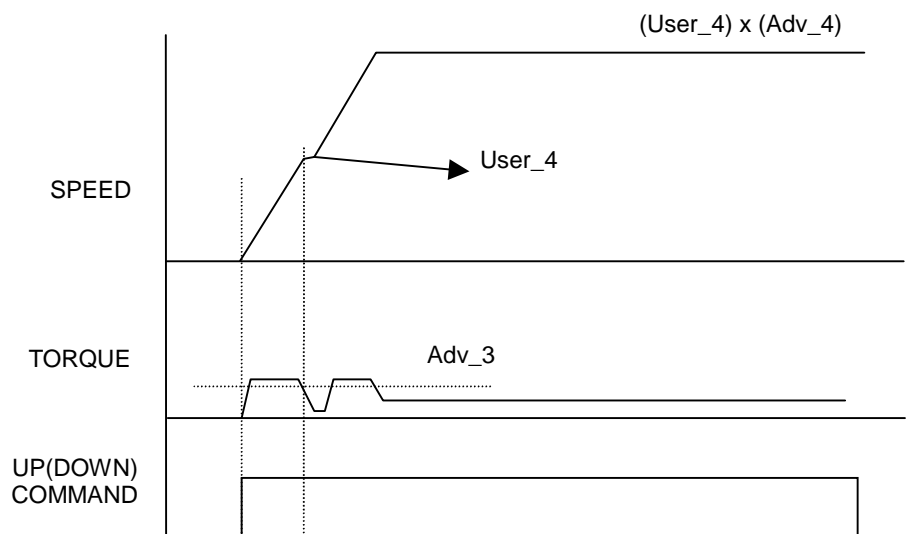

Keypad Jog Operation

Pendant - FX, RX

Code	Function	Data
SER 01	select run/stop method	Pendant

Keypad - FWD, REV, STOP

Code	Function	Data
SER 01	select run/stop method	Keypad

Set "RUN/STOP Sel" as KEYPAD

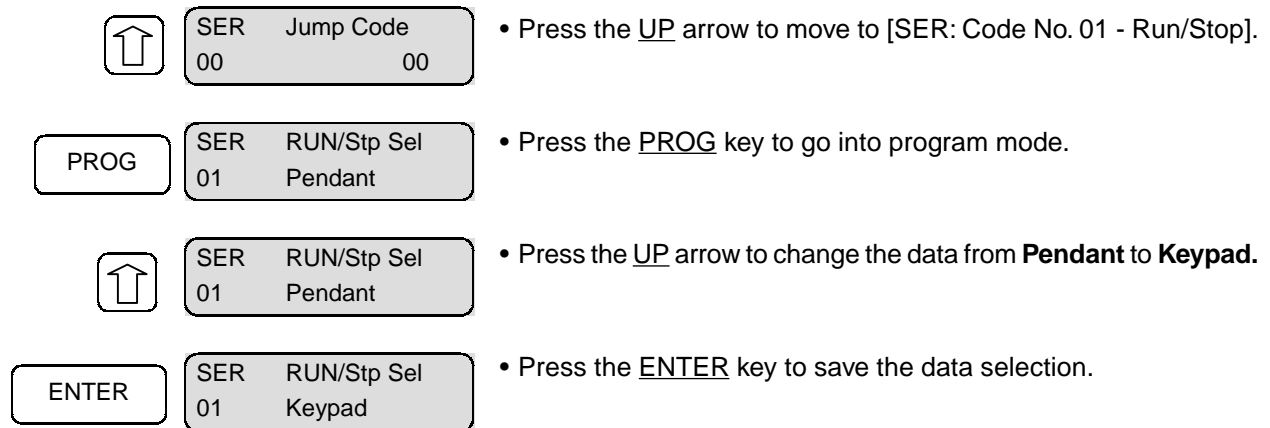

Setting to "Keypad" makes the "JOG" group appear after "Advanced"

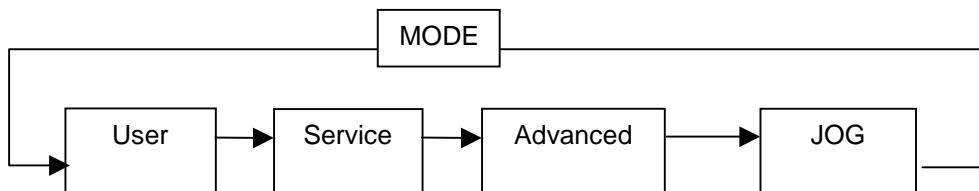

Move to "JOG" Group

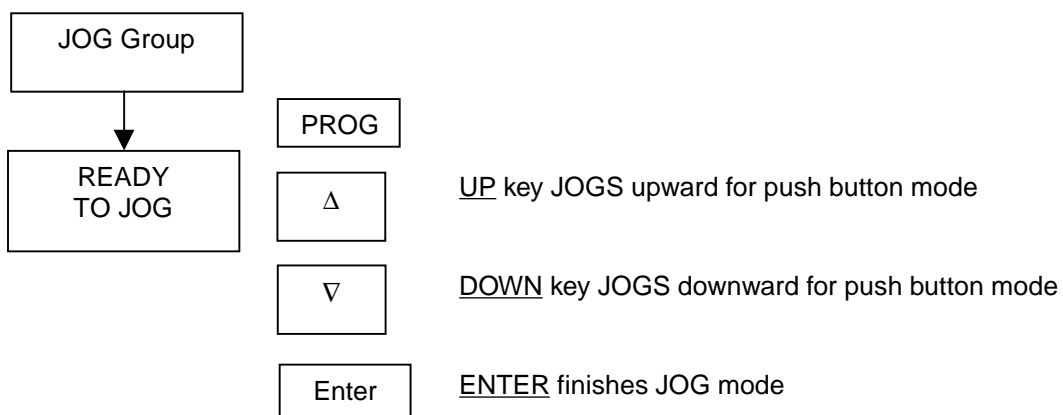

Definition of Limit Switch Input

Related Function Codes

Code Number	Display	Setting
Ser_16~Ser_20	Multi-function Input	LSW Imm. Stop LSW Rmp. Stop LSW Low Speed
User_11	LSW Speed	0 ~ 1800 RPM

Immediate Stop when Limit Switch opens

The motor stops immediately when Limit Switch opens. During LSW opening, only the run command of opposite direction is available.

Ex) Ser_20 = LSW Imm. Stop, User_11 = 100 rpm

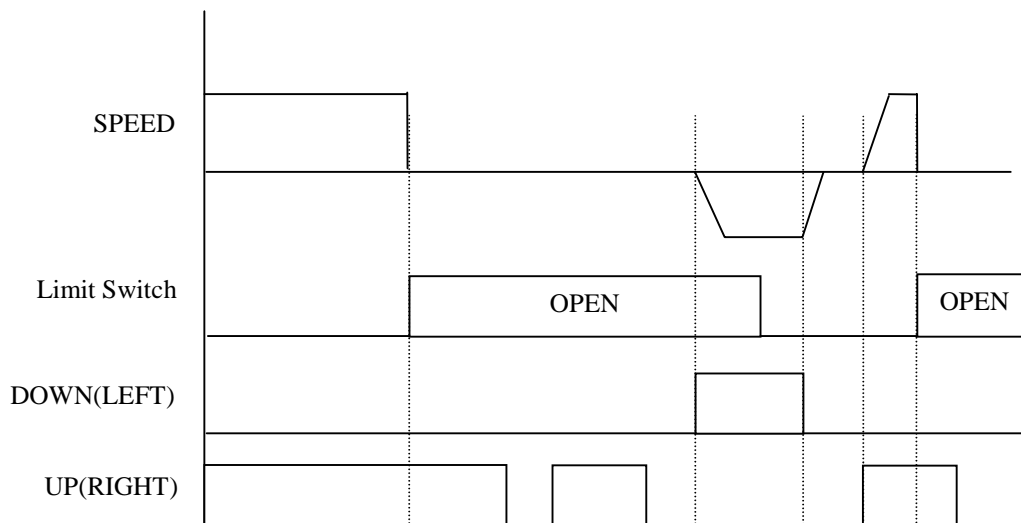

Ramp Stop when Limit Switch opens

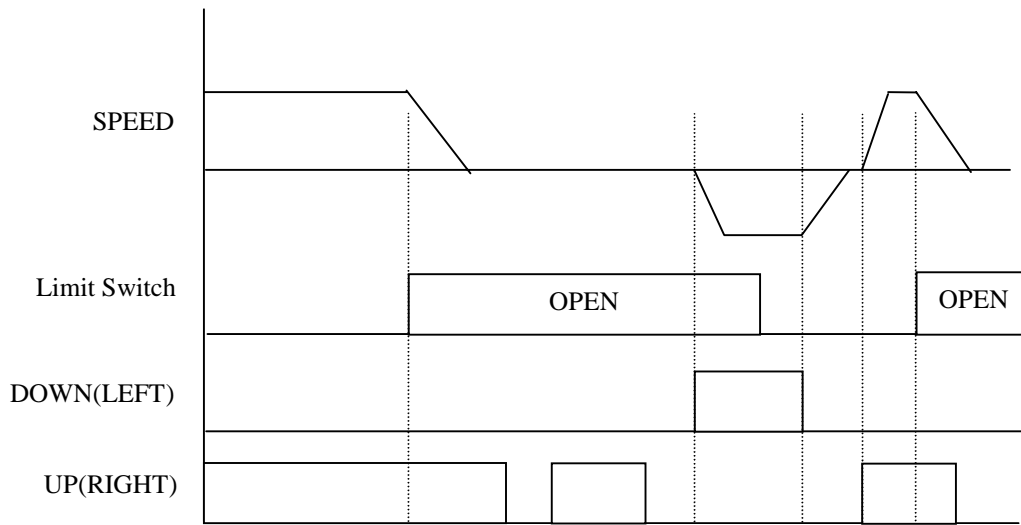

Ramp to low speed when Limit Switch opens

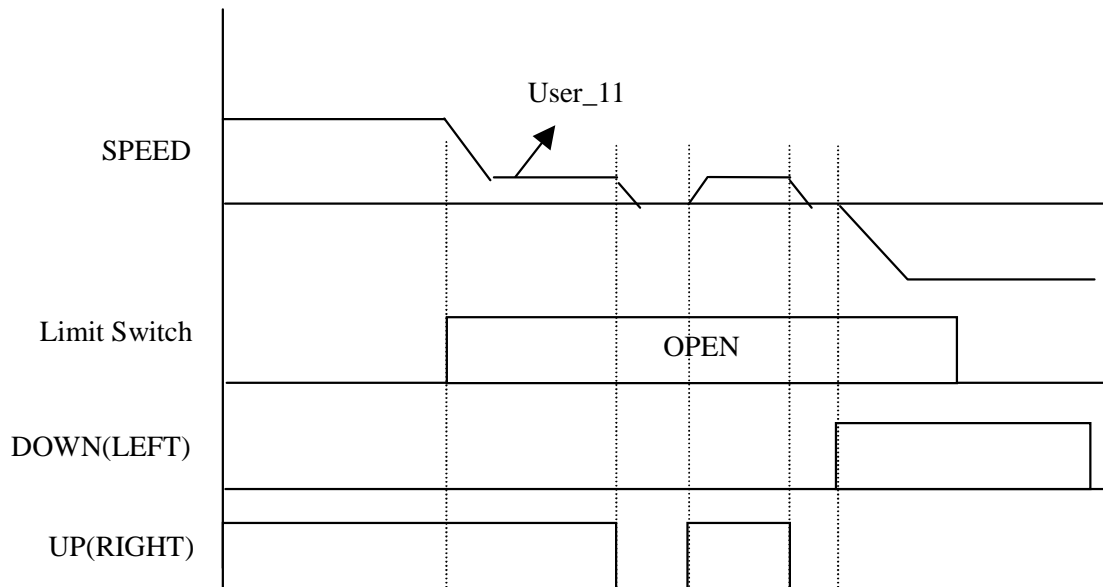

Section 6: Detail Input/Output and Function Code Descriptions

Multi-function Contact Inputs

Multi-function Contact Outputs

Function Code Descriptions

Multi-function contact inputs

SFV1000 drives have 7 multi-function contact inputs (P1~P7) and each of these inputs can be defined as one of the 15 functions below.

Code	Description	Data
SER_16	Definition of P1	0 ~ 15
SER_17	Definition of P2	0 ~ 15
SER_18	Definition of P3	0 ~ 15
SER_19	Definition of P4	0 ~ 15
SER_20	Definition of P5	0 ~ 15
SER_21	Definition of P6	0 ~ 15
SER_22	Definition of P7	0 ~ 15

Related function codes
Detail description of each function

Data	Function	Description
Not Used	Not Used	Input terminal set to 0 is not used by user
Spd Sel 1 Spd Sel 2 Spd Sel 3 Spd Sel 4	Multi-speed selection 1 Multi-speed selection 2 Multi-speed selection 3 Multi-speed selection 4	The preset speeds from USE_4 to USE_8 can be used as speed reference by these multi-speed selection
LSW Imm Stop	Acc/Dec time selection	Function to select acc/dec time. When the input is OFF, [USE: Function Code No. 9, 10] , are used and when ON, [SER: Function Code No. 10, 11] are used.
LSW Rmp Stop and	Soft start cancel	When the input is ON, the motor reaches speed reference in the shortest time without accelerating by Acc-time pattern. The decelerating is the same.
LSW Low Stop	ASR PI gain select	When the input is OFF, [SER: Function Code No. 28, 29, 30] are used as P-Gain, I-Gain and time constant of ASR LPF. When ON, [ADV: Function Code No. 22, 23, 24] are selected.

Data	Function	Description
Micro Pos	ASR P/PI select	P control or PI control is selected by User. When the input is OFF, it is PI controller.
AccDec Time Sel	Acc/Dec time selection	Function to select Acc/Dec time. When the input is OFF, USE_9, USE_10 are used and when ON, SER_10, SER_11 is used.
SoftStartCncl and	Soft start cancel	When the input is ON, the motor reaches speed reference in the shortest time without accelerating by Acc-time pattern. The decelerating is the same.
Flux Ref Sel	Flux reference select	In the case of using Vx as flux reference, flux reference is changed to the value from Vx when the input is ON.
PreExcitation	Pre-excitation	When the input is ON, inverter supplies flux current to the motor to build up the flux.
EXT Trip B	External trip input	Inverter shuts off the output when the input is OFF.
EXT Trip A	External trip input	Inverter shuts off the output when the input is ON.
Use Max Tq	Torque limiting ON	When the input is OFF, [SER: Function Code No. 31~32] are used as torque limit values and when ON, torque limit values become the maximum of the inverter.

For example, if P1 is defined as soft start cancel, P2 as pre-excitation, P3 as multi speed selection 1 , P4 as multi speed selection 2 , P5 as acc/dec time select, P6 as external trip signal input and P7as unused, than each code is set as follows:

Code	Function	Description
SER_16	Definition of P1	SoftStartCncl
SER_17	Definition of P2	PreExcitation
SER_18	Definition of P3	Spd Sel 1
SER_19	Definition of P4	Spd Sel 2
SER_20	Definition of P5	AccDec Time Sel
SER_21	Definition of P6	Ext Trip B
SER_22	Definition of P7	Not Used

Multi-function Contact Outputs

SFV1000 drives have 3 open collector outputs and 2 contact outputs (A contact) which can be used as one of the 11 functions.

Related function codes

Code	Function	Description
SER_23	Definition of AX1	0 ~ 15
SER_24	Definition of AX2	0 ~ 15
SER_25	Definition of OC1	0 ~ 15
SER_26	Definition of OC2	0 ~ 15
SER_27	Definition of OC3	0 ~ 15

Function Code Description

Zero Speed Detection

Code	Function	Description
ADV_28	Zero speed detect level	0 ~ 360 rpm
ADV_29	Zero speed detect band	0.1 ~ 10%

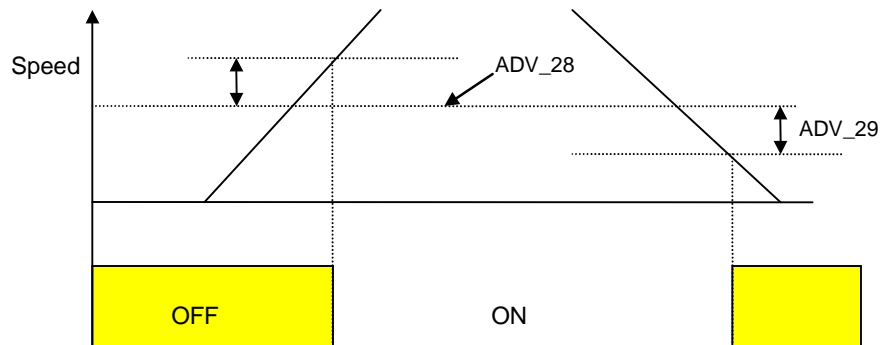

Speed detection (polarity available or ignored)

Code	Function	Description
ADV_30	Speed detection level	-3600 ~ 3600 rpm
ADV_31	Speed detection band	0.1 ~ 10%

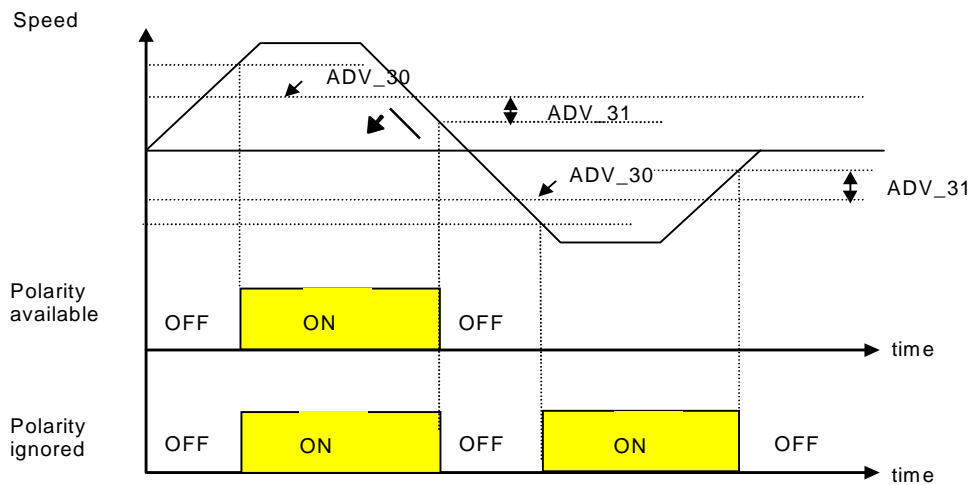

Speed Arrival and Speed Deviation

Code	Function	Description
ADV_32	Speed arrival band	0.1 ~ 10%
SER_9	Speed deviation band	0.1 ~ 10%

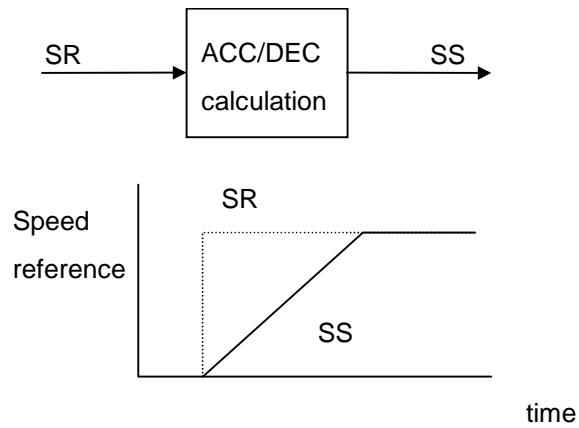

Speed arrival signal is output only when the motor is in the steady state but speed deviation is checked even in the transient time as well as the steady state.

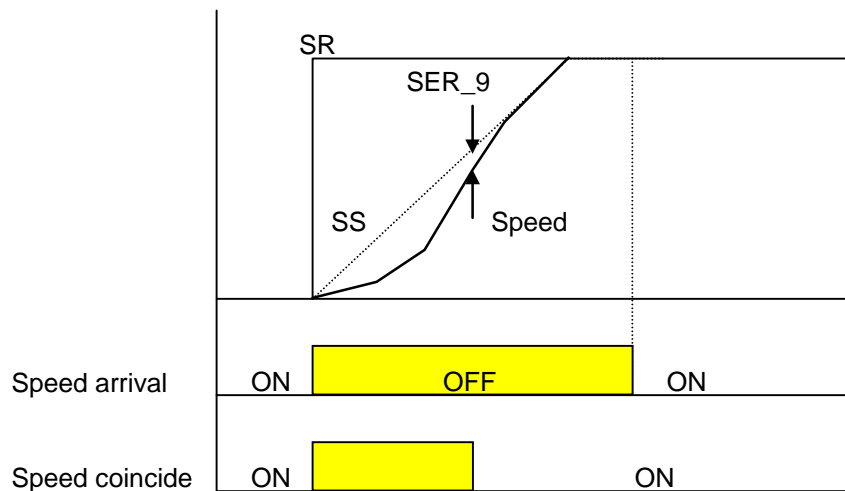

Torque detection, motor overheat warning and inverter overheat warning operates the same as speed detection signal. The motor overheat warning and the inverter overheat warning are the alarm signals and the inverter does not shut off the output. They are different from motor overheat trip(MOH) and inverter overheat trip(IOH).

Setting the speed

The speed can be set either by Keypad or by Multi-speed selection. With the function of Multi-speed selection, up to 6 preset speeds are available.

Multi-speed operation by keypad setting

Related Codes

Code	Function	Description
USE_4	multi speed 1	0 ~ 3600 <small>Note: max speeds are determined by SER: Function Code No. 36]</small>
USE_5	multi speed 2	0 ~ 3600
USE_6	multi speed 3	0 ~ 3600
USE_7	multi speed 4	0 ~ 3600
USE_8	multi speed 5	0 ~ 3600

Define multi-function inputs

Up to 4 multi-function inputs can be defined as Multi-speed selection and one of the 5 preset speeds can be used as speed reference by the combination of 4 inputs. For example, P1,P2,P3,P4 are defined as multi-speed selection 1,2,3,4.

Code	Function	Description
SER_16	Definition of P1	Spd Sel 1
SER_17	Definition of P2	Spd Sel 2
SER_18	Definition of P3	Spd Sel 3
SER_19	Definition of P4	Spd Sel 4
SER_20	Definition of P5	
SER_21	Definition of P6	
SER_22	Definition of P7	

The relation between the preset speeds and the selection inputs is as follows.

P1	P2	P3	P4	Speed
OFF	OFF	OFF	OFF	USE_4
ON	OFF	OFF	OFF	USE_5
ON	ON	OFF	OFF	USE_6
ON	ON	ON	OFF	USE_7
ON	ON	ON	ON	USE_8

Run/Stop Method

Pendant - FX, RX

Code	Function	Description
SER_1	Select Run/Stop method	Pendant

Keypad - FWD, REV, STOP

Code	Function	Description
SER_1	Select Run/Stop method	Keypad

1) First - Set "RUN/STOP Sel" as KEYPAD

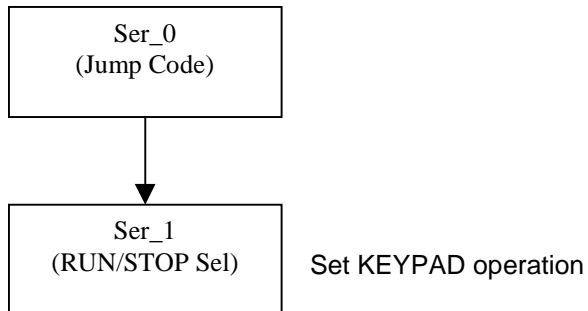

2) Setting "KEYPAD" makes "JOG" Group after "Advanced"

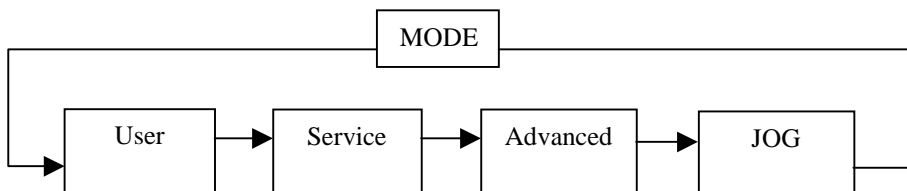

Move to "JOG" Group

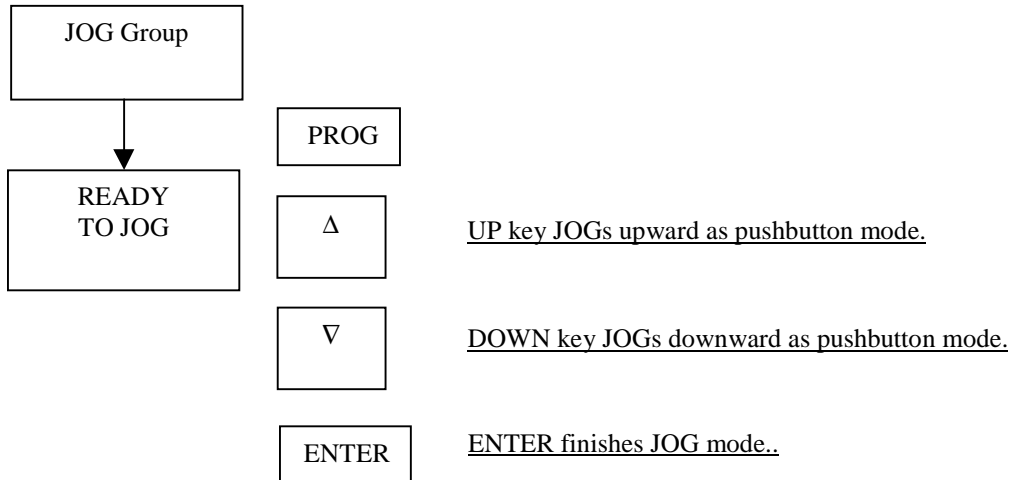

Emergency stop

Terminal BX can be used when the motor should be stopped in the situation of an emergency.

Related Code

Code	Function	Description
ADV_39	Dec time when BX is ON	0 ~ 3600 sec

When BX is ON, the motor decelerates with the slope set in ADV_39 but if the motor does not stop within the time selected, the motor will free run. If the motor should be in free run immediately when BX is ON, ADV_39 is set 0 sec.

Acceleration/Deceleration pattern and time (soft start)

SFV1000 provides 2 sets of acc/dec time each of which can be selected by the multi-function input - acc/dec time selection. The s-curve pattern as well as the linear is available.

Selection of Acc/Dec Time

Related codes

Code	Function	Data
USE_9	Acc Time 1	0.1 ~ 3600 sec
USE_10	Dec Time 1	0.1 ~ 3600 sec
SER_10	Acc Time 2	0.1 ~ 3600 sec
SER_11	Dec Time 2	0.1 ~ 3600 sec

Define multi-function input

In order to select acc/dec time among 2 sets above, the acc/dec time selection of multi-function input can be used. For example, when P4 is used as this function, P4 should be set 'Acc Dec Time Sel' and the operation is as follows.

Code	Function	Data
SER_19	Definition of P4	Acc Dec Time Sel

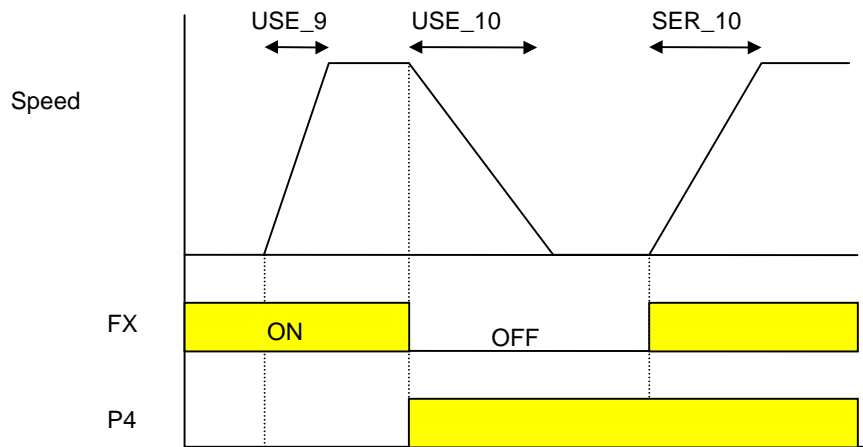

Definition of Acc/Dec Time

All kinds of acc/dec time including BX decel time is the time to reach maximum speed (SER_36). For example, when the user sets acc time as 5 sec, maximum speed as 3000 rpm and speed reference as 1500 rpm, the acc time to reach 1500 rpm is 2.5 sec.

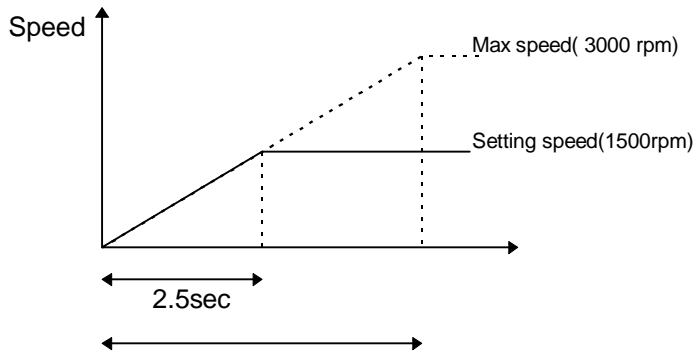

Soft start cancel

Soft start cancel - one of the multi-function input - accelerates or decelerates motor as fast as possible without acc/dec time and pattern. For example, when P5 is defined as this function, the code setting and the operation is as follows.

Definition of multi-function input

Code	Function	Data
SER_20	Definition of P5	SoftStartCncl

In this case, actual acceleration time depends on the load condition and the gains of speed controller.

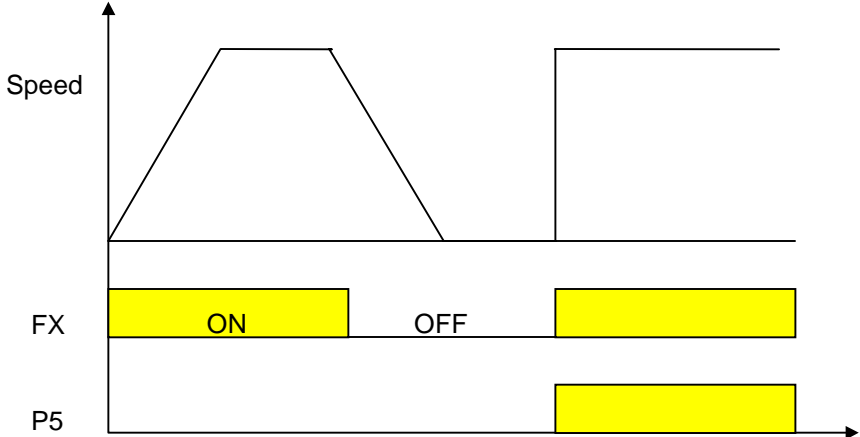

Pattern - linear and s-curve

Definition of s-curve and related codes

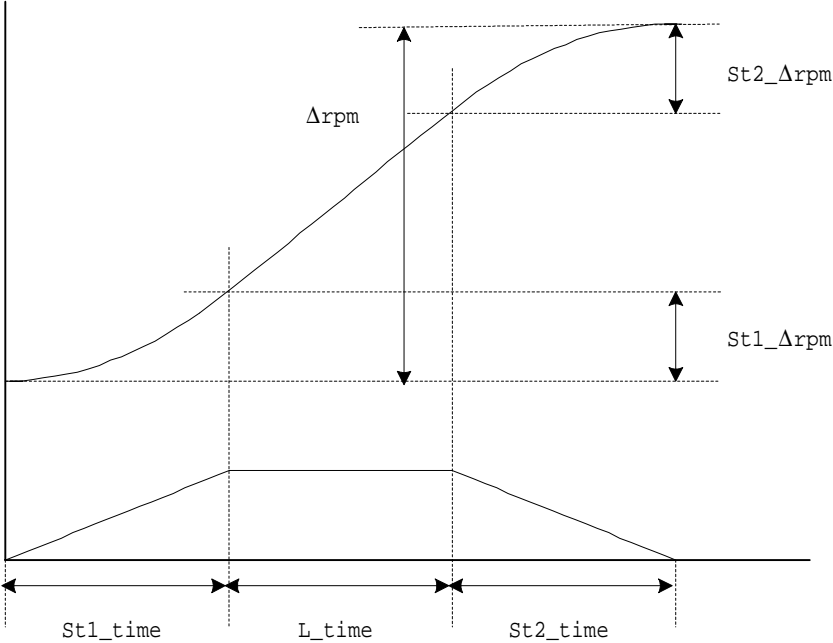

➤ **Basic Calculation**

$$St1_Time = AccTime \times \frac{ST1(\%)}{50.0}$$

$$St2_Time = AccTime \times \frac{ST2(\%)}{50.0}$$

$$St1_Δrpm = St1_Time \times \frac{Max_Speed}{AccTime} \times \frac{1}{2}$$

$$St2_Δrpm = St2_Time \times \frac{Max_Speed}{AccTime} \times \frac{1}{2}$$

➤ **Calc. 1. In Case of •rpm ≥ St1_•rpm + St2_•rpm**

In this Case •rpm = the difference of motor speed and target speed

$$Total\ Acceleration\ Time = St1_Time + L_Time + St2_Time$$

➤ **Calc. 2. In Case of • rpm < St1 • rpm + St2 • rpm**

$$St1'_{Time} = \sqrt{\frac{\Delta rpm \times AccTime^2 \times St1_time^2}{25 \times MaxSpeed \times (St1_time + St2_time)}}$$

$$St2'_{Time} = \sqrt{\frac{\Delta rpm \times AccTime^2 \times St2_time^2}{25 \times MaxSpeed \times (St1_time + St2_time)}}$$

Total Acceleration Time = St1' _ Time + St2' _ Time

Δrpm : Speed Variation
 Max_Speed : Max Speed(SER_36)
 AccTime : Acceleration Time to set (USE_9 or USE_10)
 St1_Δrpm : In Acceleration, SER_12 Acc. Start ST% is applied,
 In Deceleration, SER_13 Dec Speed Arrival ST% is applied
 St2_Δrpm : In Acceleration, SER_14 Acc Speed Arrival ST% is applied,
 In Deceleration, SER_15 Dec. Start ST% is applied
 St1_Time : The Time of getting the St1_Δrpm
 St2_Time : The Time of getting the St2_Δrpm

Code	Function	Data
SER_12	S-Curve rate 1 in acc	0 ~ 50%
SER_14	S-Curve rate 2 in acc	0 ~ 50%
SER_13	S-Curve rate 1 in dec	0 ~ 50%
SER_15	S-Curve rate 2 in dec	0 ~ 50%

Speed controller (ASR : Automatic Speed Regulator)

ASR regulates the motor speed with the speed reference determined by multi-speed selection. The PI (proportional and integral) controller is the basic structure and P controller can be used.

Related codes of encoder feedback

Code	Function	Data
SER_38	No. of encoder pulse	500 ~ 8000
SER_39	Time Constant for encoder LPF	0 ~ 2 sec

Select the parameters of ASR

Code	Function	Data
SER_28	ASR P gain 1	5 ~ 200%
SER_29	ASR I gain 1	0 ~ 5000 msec
SER_30	ASR LPF Tr 1	0 ~ 2000 sec

By using ASR PI gain select - one of the multi-function input, the p gain, I gain and the time constant of ASR LPF can be selected among 2 sets above .When the input defined as ASR PI gain is OFF, the set of SER_28,SER_29,SER_30 is used.

Flux controller

The flux controller determines the flux level of the motor according to motor speed. The controller maintains the rated flux level in the constant torque region and the flux level is reduced in the constant power region. The output of flux controller (I_d^*) is used as reference of current controller.

Pre-excitation

The function of pre-excitation - one of the multi-function input is applied to build up the flux of the motor before the run command is ON. When P3 is defined as pre-excitation , the operation is as follows.

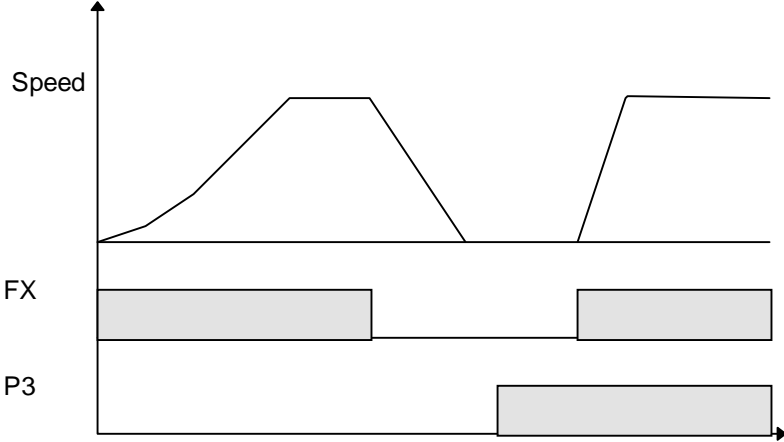

Current controller (ACR:Automatic Current Regulator)

The current controller regulates the motor current with the reference from speed controller (i_q^*) and flux controller (i_d^*). When torque control mode is selected, (i_q^*) comes from multi-function analog input.

Torque limit

The SFV1000 applies 3 different torque limit values - forward motoring, reverse motoring and regenerating torque limit.

Code	Function	Data
SER_31	torque limit in 1st quadrant	0 ~ 250%
SER_32	torque limit in 3rd quadrant	0 ~ 250%
SER_33	torque limit in regeneration	0 ~ 250%

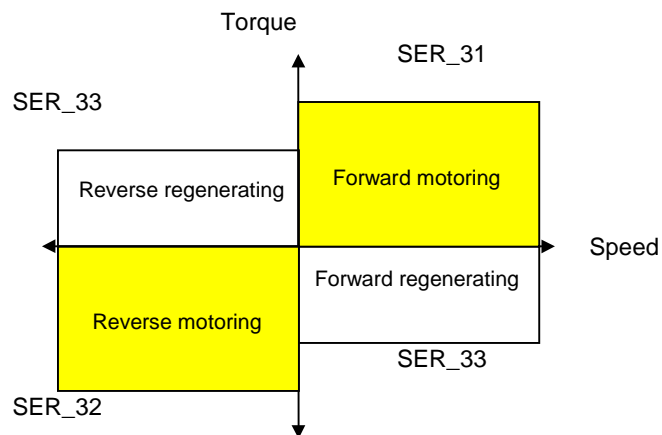

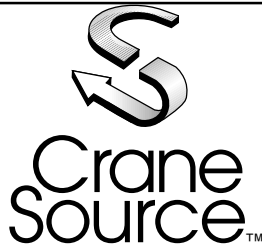

414 W. BROADWAY AVE.
MUSKEGON, MI 49443-0769

Phone: 877 226-6278 (toll free)
Fax: 800 742-9270

53-D COWANSVIEW ROAD
CAMBRIDGE, ONTARIO, N1R 7L2

Phone: 519 621-3201
Fax: 519 621-3125

P.O. BOX 1000
FORREST CITY, AR 72335

Phone: 800 999-6318
Fax: 800 766-0223

WARRANTY

WARRANTY AND LIMITATION OF REMEDY AND LIABILITY

A. Seller warrants that its products and parts, when shipped, and its work (including installation, construction and start-up), when performed, will meet applicable specifications, will be of good quality and will be free from defects in material and workmanship. All claims for defective products or parts under this warranty must be made in writing immediately upon discovery and, in any event, within two (2) years (or as otherwise provided) from shipment of the applicable item unless Seller specifically assumes installation, construction or start-up responsibility. All claims for defective products or parts when Seller specifically assumes installation, construction or start-up responsibility, and all claims for defective work must be made in writing immediately upon discovery and, in any event, within two (2) years (or as otherwise provided) from completion of the applicable work by Seller, provided, however, all claims for defective products and parts must be made in writing no later than thirty (30) months after shipment. Defective items must be held for Seller's inspection and returned to the original f.o.b. point upon request. **THE FOREGOING IS EXPRESSLY IN LIEU OF ALL OTHER WARRANTIES WHATSOEVER, EXPRESS, IMPLIED AND STATUTORY, INCLUDING, WITHOUT LIMITATION, THE IMPLIED WARRANTIES OF MERCHANTABILITY AND FITNESS.**

B. Upon Buyer's submission of a claim as provided above and its substantiation, Seller shall, at its option, either (i) repair or replace its product, part or work at either the original f.o.b. point of delivery or at Seller's authorized service station nearest Buyer or (ii) refund an equitable portion of the purchase price.

C. This warranty is contingent upon Buyer's proper maintenance and care of Seller's products, and does not extend to normal wear and tear. Seller reserves the right to void warranty in event of Buyer's use of inappropriate materials in the course of repair or maintenance, or if Seller's products have been dismantled prior to submission to Seller for warranty inspection.

D. The foregoing is Seller's only obligation and Buyer's exclusive remedy for breach of warranty, and is Buyer's exclusive remedy hereunder by way of breach of contract, tort, strict liability or otherwise. In no event shall Buyer be entitled to or Seller liable for incidental or consequential damages. Any action for breach of this warranty must be commenced within two (2) years (or as otherwise provided) after the cause of action has accrued.