

Note: When ordering parts, always furnish rated load and serial number of hoist on which the parts are to be used.
For the location of the nearest CM Master Parts Depot, see the list located on the inside front cover.

LIMITATION OF WARRANTIES, REMEDIES AND DAMAGES

THE WARRANTY STATED BELOW IS GIVEN IN PLACE OF ALL OTHER WARRANTIES, EXPRESS OR IMPLIED, OF MERCHANTABILITY, FITNESS FOR A PARTICULAR PURPOSE, OR OTHERWISE, NO PROMISE OR AFFIRMATION OF FACT MADE BY ANY AGENT OR REPRESENTATIVE OF SELLER SHALL CONSTITUTE A WARRANTY BY SELLER OR GIVE RISE TO ANY LIABILITY OR OBLIGATION.

Seller warrants that on the date of delivery to carrier the goods are free from defects in workmanship and materials.

SELLER'S SOLE OBLIGATION IN THE EVENT OF BREACH OF WARRANTY OR CONTRACT OR FOR NEGLIGENCE OR OTHERWISE WITH RESPECT TO GOODS SOLD SHALL BE EXCLUSIVELY LIMITED TO REPAIR OR REPLACEMENT, F.O.B. SELLER'S POINT OF SHIPMENT, OF ANY PARTS WHICH SELLER DETERMINES TO HAVE BEEN DEFECTIVE or if Seller determines that such repair or replacement is not feasible, to a refund of the purchase price upon return of the goods to Seller.

Any action against Seller for breach of warranty, negligence or otherwise, must be commenced within one year after such cause of action occurs.

NO CLAIM AGAINST SELLER FOR ANY DEFECT IN THE GOODS SHALL BE VALID OR ENFORCEABLE UNLESS BUYER'S WRITTEN NOTICE THEREOF IS RECEIVED BY SELLER WITHIN ONE YEAR FROM THE DATE OF SHIPMENT. Seller shall not be liable for any damage, injury or loss arising out of the use of the goods if, prior to such damage, injury or loss, such goods are (1) damaged or misused following Seller's delivery to carrier; (2) not maintained, inspected, or used in compliance with applicable law and Seller's written instructions and recommendations; or (3) installed, repaired,

altered or modified without compliance with such law, instructions or recommendations. UNDER NO CIRCUMSTANCES SHALL SELLER BE LIABLE FOR INCIDENTAL OR CONSEQUENTIAL DAMAGES AS THOSE TERMS ARE DEFINED IN SECTION 2-715 OF THE UNIFORM COMMERCIAL CODE.

INDEMNIFICATION AND SAFE OPERATION

Buyer shall comply with and require its employees to comply with directions set forth in instructions and manuals furnished by Seller and shall use and require its employees to follow such instructions and manuals and to use reasonable care in the use and maintenance of the goods. Buyer shall not remove or permit anyone to remove any warning or instruction signs on the goods. In the event of personal injury or damage to property or business arising from the use of the goods, Buyer shall within 48 hours thereafter give Seller written notice of such injury or damage. Buyer shall cooperate with Seller in investigating any such injury or damage and in the defense of any claims arising therefrom.

If Buyer fails to comply with this section or if any injury or damage is caused, in whole or in part, by Buyer's failure to comply with applicable federal or state safety requirements, Buyer shall indemnify and hold Seller harmless against any claims, loss or expense for injury or damage arising from the use of the goods.

**OPERATING,
MAINTENANCE &
PARTS MANUAL**

**HAND OPERATED
CHAIN HOIST**



CM[®] SERIES 622

Rated Loads:
1/2, 1, 2, 3, 5 and 10 tons
(500,1000, 2000, 3000, 5000,
and 10,000kg.)

Follow all instructions and warnings for inspecting, maintaining and operating this hoist. The use of any hoist presents some risk of personal injury or property damage. That risk is greatly increased if proper instructions and warnings are not followed. Before using this hoist, each operator should become thoroughly familiar with all warnings, instructions and recommendations in this manual. **Retain this manual for future reference and use.**

Forward this manual to operator. Failure to operate equipment as directed in manual may cause injury.

Before installing hoist, fill in the information below.

Rated Load _____

Serial No. _____

Purchase Date _____



Columbus McKinnon Corporation • Industrial Products Division • 140 John James Audubon Parkway
Amherst, New York 14228-1197 • 1-800-888-0985 • Fax 716-689-5644

CM HOIST PARTS AND SERVICES ARE AVAILABLE IN THE UNITED STATES AND IN CANADA

As a CM Hoist user, you are assured of reliable repair and parts services through a network of Master Parts Depots and Service Centers that are strategically located in the United States and Canada. These facilities have been selected on the basis of their demonstrated ability to handle all parts and repair requirements promptly and efficiently.

Below is a list of the Master Parts Depots in the United States and Canada. To quickly obtain the name of the U.S. Service Center located nearest you, call (800) 888-0985. Fax: (716) 689-5644. In the following list, the Canadian Service Centers are indicated.

UNITED STATES MASTER PARTS DEPOT

ALABAMA

ABB POWER SERVICES
612 32nd Street, South
Birmingham, AL 35233
205/328-5952
Fax 205/251-6759

CALIFORNIA

OTTO SYSTEMS, INC.
12010 Bloomfield Ave.
Santa Fe Springs, CA 90670
310/462-1612
Fax 310/462-1617
or
2439 Verna Court
San Leandro, CA 94577
510/667-3730
Fax 510/667-3726

COLORADO

MATERIALS HANDLING EQUIPMENT CO.
1740 W. 13th Ave.
Denver, CO 80204
303/573-5333
Fax 303/893-3854

FLORIDA

TAMPA ARMATURE WORKS, INC.
440 South 78th Street
Tampa, FL 33619
813/621-5661
Fax 813/622-7040

GEORGIA

ACE INDUSTRIES, INC.
6295 McDonough Drive
Norcross, GA 30093
770/441-0898
Fax 770/441-0326

ILLINOIS

SERVICE ELEVATOR & ELEC. CO.
5819 West Irving Park Rd.
Chicago, IL 60634
312/545-5848
Fax 312/545-8610

TORRANCE ELECTRIC COMPANY

415-31st. Ave.
Rock Island, IL 61204-6008
309/786-7777
Fax 309/786-8705

INDIANA

HORNER ELECTRIC COMPANY, INC.
1521 East Washington St.
Indianapolis, IN 46201
317/639-4261
Fax 317/639-4269

LOUISIANA

BEERMAN PRECISION, INC.
4206 Howard Avenue
New Orleans, LA 70125
504/486-9391
Fax 504/486-7482

MASSACHUSETTS

ABEL DISTRIBUTORS, INC.
70 Flagship Drive
N. Andover, MA 01845
508/975-8234
Fax 508/683-7025

MICHIGAN

GAYLORD HOIST SALES & SERVICE
34471 Industrial Road
Livonia, MI 48150
313/261-1910
Fax 313/261-1788

MISSOURI

INDEPENDENT ELECTRIC MACHINERY
310 West 20th Street
Kansas City, MO 64108
816/471-2610
Fax 816/421-3054

NEW JERSEY

LIVELY AND COMPANY
10 Merry Lane
East Hanover, NJ 07936
201/887-6440
Fax 201/887-9586

NEW YORK

VOLLAND ELECTRIC EQUIPMENT CO.
75 Innsbruck Drive
Buffalo, NY 14227
716/656-9900
Fax 716/656-8898, 8899

NORTH CAROLINA

SOUTHERN ELECTRIC SERVICE CO., INC.
2225 Freedom Drive
Charlotte, NC 28208
704/372-4832
Fax 704/342-2604

OHIO

MAZZELLA WIRE ROPE & SLING COMPANY
14600 Brookpark Road
Cleveland, OH 44135
216/362-4600
Fax 216/362-4952

PENNSYLVANIA

AMICK ASSOCIATES, INC.
11 Sycamore Street
Carnegie, PA 15106-0529
412/429-1212
Fax 412/429-0191

RAM INDUSTRIES, INC.

70 Pitney Rd.
Lancaster, PA 17602
717/392-2128
Fax 717/392-2788

TEXAS

ABEL EQUIPMENT CO., INC.
3710 Cavalier Drive
Garland, TX 75042
214/272-7706
Fax 214/272-6955

HYDRAULIC EQUIPMENT SERVICE, INC.

1021 North San Jacinto St.
Houston, TX 77002
713/228-9601
Fax 713/228-0931

WASHINGTON

UNITED ELECTRIC MOTORS
308 9th Ave. North
Seattle, WA 98109
206/624-0044
Fax 206/622-4894

WISCONSIN

TRESTER HOIST & EQUIPMENT, INC.
4465 North 124th St., Unit B
Brookfield, WI 53005
414/790-0700
Fax 414/790-1009

CANADIAN SERVICE CENTERS

ALBERTA

*COLUMBUS MCKINNON, LTD.
10311-174th Street
Edmonton, Alberta T8H 1N3

NOVA SCOTIA

*W & A MOIR
95 Ilsley Ave.
Dartmouth, Nova Scotia B3B 1L5
902/468-7720
Fax 902/468-3777

ONTARIO

*R & W HOIST REPAIR, LTD.
790 Redwood Square
Units 5, 6, & 7
Oakville, Ontario L6L 6N3
905/825-5500
Fax 905/825-5315

*TORONTO ELECTRIC HOIST

SALES & SERVICE
72 Crockford Blvd.
Scarborough, Ontario M1R 3C4
416/755-7716
Fax 800/461-0290

*MASLACK SUPPLY, LTD.

488 Falconbridge Road
Sudbury, Ontario P3A 4S4
705/566-1270
Fax 705/566-4208

*COLUMBUS MCKINNON, LTD.

P.O. Box 1106
10 Brook Road, North
Cobourg, Ontario K9A 4W5
905/372-0153
Fax 905/372-3078

QUEBEC

*HERCULES SLING & CABLE
2525 Louis A. Amos
Lachine, Quebec H8T 1C3
514/631-5511
Fax 514/636-1084

*LEGER HOIST EQUIPMENT CO.

7995-17th Ave.
Montreal, Quebec H1Z 3R2
514/376-3050
Fax 514/376-0657

* ARE ALSO MASTER PARTS DEPOTS

** MASTER PARTS DEPOT ONLY

Hoist safety is up to you...

! WARNING — DO NOT LIFT MORE THAN RATED LOAD.

1 CHOOSE THE RIGHT HOIST FOR THE JOB...

Choose a hoist with the capacity for the job. Know the capacities of your hoists and the weight of your loads. Then match them.

The application, the size and type of load, the attachments to be used and the period of use must also be taken into consideration in selecting the right hoist for the job.

Remember the hoist was designed to ease our burden and carelessness not only endangers the operator, but in many cases, a valuable load.



! WARNING — DO NOT OPERATE DAMAGED OR MALFUNCTIONING HOIST.
— DO NOT OPERATE WITH TWISTED, KINKED OR DAMAGED CHAIN.

2 INSPECT

All hoists should be visually inspected before use, in addition to regular, periodic maintenance inspections.

Inspect hoists for operations warning notices and legibility.

Deficiencies should be noted and brought to the attention of supervisors. Be sure defective hoists are tagged and taken out of service until repairs are made.



Under no circumstances should you operate a malfunctioning hoist.

Check for gouged, twisted, distorted links and foreign material. Do not operate hoists with twisted, kinked or damaged chain links.

Load chain should be properly lubricated.

Hooks that are bent, worn or whose openings are enlarged beyond normal throat opening should not be used. If latch does not engage throat opening of hook, hoist should be taken out of service.

Chains should be checked for deposits of foreign material which may be carried into the hoist mechanism.

Check brake for evidence of slip-page under load.



! WARNING — DO NOT PULL AT AN ANGLE. BE SURE HOIST AND LOAD ARE IN A STRAIGHT LINE.
— DO NOT USE LOAD CHAIN AS A SLING.

3 USE HOIST PROPERLY

Be sure hoist is solidly held in the uppermost part of the support hook arc.

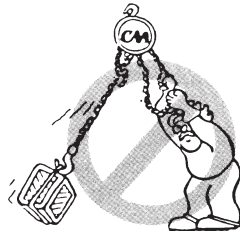
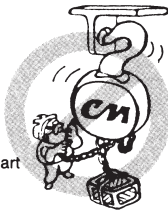

Be sure hoist and load are in a straight line. Do not pull at an angle.

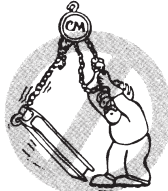

Be sure load is hooked securely. Do not tip load the hook. Do not load hook latch. Hook latch is to prevent detachment of load under slack chain conditions only.



Do not operate with hoist head resting against any object. Lift the load gently. Do not jerk it.

! WARNING — DO NOT LIFT PEOPLE OR LOADS OVER PEOPLE.

4 PRACTICE CAUTION ALWAYS

Do not lift co-workers with a hoist.

Make sure everyone is clear of the load when you lift.

Do not remove or obscure operational warning notices.

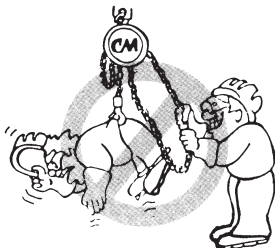

5 OPERATOR SERVICE

CLEANING

Hoists should be kept clean and free of dust, dirt, moisture, etc., which will in any way affect the operation or safety of the equipment.

LUBRICATION

Chain should be properly lubricated.

AFTER REPAIRS

Carefully operate the hoist before returning it to full service.

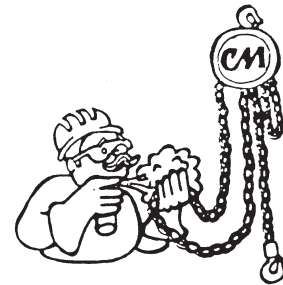

VIOLATIONS OF ANY OF THE WARNINGS LISTED MAY RESULT IN SERIOUS PERSONAL INJURY TO THE OPERATOR OR NEARBY PERSONNEL BY NATURE OF RELEASED LOAD OR BROKEN HOIST COMPONENTS.

SAFETY PRECAUTIONS

Each Series 622 Hand Hoist is built in accordance with the specifications contained herein and at the time of manufacture complies with our interpretation of applicable sections of the * American Society of Mechanical Engineers Code B30.16 "Overhead Hoist" and the Occupation Safety and Health Act.

The safety laws for elevators and for dumbwaiters may specify construction details that are not necessarily incorporated in CM industrial hoists. We recommend the use of equipment that meets state and national safety codes. Columbus McKinnon Corporation cannot be responsible for applications other than those for which CM equipment is recommended.



THIS SYMBOL POINTS OUT IMPORTANT SAFETY INSTRUCTIONS WHICH IF NOT FOLLOWED COULD ENDANGER THE PERSONAL SAFETY AND/OR PROPERTY OF YOURSELF AND OTHERS. READ AND FOLLOW ALL INSTRUCTIONS IN THIS MANUAL AND ANY PROVIDED WITH THE EQUIPMENT BEFORE ATTEMPTING TO OPERATE YOUR SERIES 622 HOIST.



Consult Columbus McKinnon Corporation for any usage of Series 622 Hoists that do not involve raising of the load on the lower hook, or usage of Series 622 Hoists in the inverted position. Using hoists, without special precautions, in such applications may cause an accident that could result in injury and/or property damage.

* Copies of this standard can be obtained from ASME Order Department, 22 Law Drive, Box 2300, Fairfield, NJ 07007-2300, U.S.A.

DO'S AND DO NOT'S

Safe Operation of Hoists

The following are Do's and Do Not's for safe operation of overhead hoists. Taking precedence over any specific rule listed here, however, is the most important rule of all, USE COMMON SENSE. A few minutes spent reading these rules can make an operator aware of dangerous practices to avoid and precautions to take for his own safety and the safety of others. Frequent examinations and periodic inspections of the equipment as well as a conscientious observance of safety rules may save lives as well as time and money.



WARNING - To Avoid Injury:

1. **DO** read ASME B30.16 Safety Standard for Overhead Hoists and this manual thoroughly.
2. **DO** be familiar with hoist operating controls, procedures and warnings.
3. **DO** make sure the hoist suspension hook is securely attached to a suitable support.
4. **DO** maintain firm footing or be otherwise secured when operating hoist.
5. **DO** make sure that load slings or other approved single attachments are properly sized and seated in the hook saddle.
6. **DO** make sure that the hook latch, if used, is closed and not supporting any part of the load.
7. **DO** make sure that load is free to move and will clear all obstructions.
8. **DO** take up slack chain carefully, check load balance, lift a few inches (centimeters) and check load holding action before continuing.
9. **DO** make sure that all persons stay clear of the suspended load.
10. **DO** avoid swinging of load or load hook.
11. **DO** protect load chain from weld spatter or other damaging contaminants.
12. **DO** promptly report any malfunction, unusual performance, or damage of the hoist.
13. **DO** inspect hoist regularly, replace damaged or worn parts, and keep appropriate records of maintenance.
14. **DO** use CM parts when repairing a hoist.
15. **DO** use hook latches wherever possible.
16. **DO** apply lubricant to the load chain as recommended in this manual.
17. **DO** replace damaged or malfunctioning hook latch.
18. **DO NOT** lift more than rated load.
19. **DO NOT** use damaged hoist or hoist that is not working correctly.
20. **DO NOT** use the hoist with twisted, kinked, damaged or worn chain.
21. **DO NOT** lift a load unless chain is properly seated in chain wheel(s).
22. **DO NOT** use load chain as a sling or wrap chain around the load.
23. **DO NOT** lift a load if any binding prevents equal loading on all supporting chains.
24. **DO NOT** apply the load to the tip of the hook.
25. **DO NOT** operate unless load is centered under hoist.
26. **DO NOT** operate hoist with other than manual power.
27. **DO NOT** permit more than one operator to pull on a single hand chain at one time.
28. **DO NOT** allow your attention to be diverted from operating the hoist.
29. **DO NOT** operate the hoist beyond limits of load chain travel.
30. **DO NOT** use hoist to lift, support or transport people.
31. **DO NOT** lift loads over people.
32. **DO NOT** leave a suspended load unattended unless specific precautions have been taken.
33. **DO NOT** allow sharp contact between two hoists or between hoist and obstructions.
34. **DO NOT** allow the chain or hook to be used as a ground for welding.
35. **DO NOT** allow the chain or hook to be touched by a live welding electrode.
36. **DO NOT** remove or obscure the warnings on the hoist.
37. **DO NOT** adjust or repair a hoist unless qualified to perform hoist maintenance.
38. **DO NOT** attempt to lengthen the load chain or repair damaged load chain.

GENERAL INFORMATION

This manual contains important information to help you properly install, operate and maintain your Series 622 Hoist for maximum performance, economy and safety.

Please study its contents thoroughly before putting your hoist into operation. By practicing correct operating procedures and by carrying out the recommended preventive maintenance suggestions, you will be assured of long, dependable and safe service. After you have completely familiarized yourself with the contents of this manual, we recommend that you carefully file it for future reference.

The information herein is directed to the proper use, care and maintenance of the Series 622 Hoist and does not comprise a handbook on the broad subject of rigging.

Rigging can be defined as the process of lifting and moving heavy loads using hoists and other mechanical equipment. Skill acquired through specialized experience and study is essential to safe rigging operations. For rigging information, we recommend consulting a standard textbook on the subject.

CM REPAIR/REPLACEMENT POLICY

All Columbus McKinnon (CM) Series 622 Hoists are inspected and performance tested prior to shipment. If any properly maintained hoist develops a performance problem, within one year of shipment, due to a material or workmanship defect, as verified by CM, repair or replacement of the unit will be made to the original purchaser without charge. This repair/replacement policy applies only to Series 622 Hoists installed, maintained and operated as outlined in this manual, and specifically excludes hoists subject to normal wear, abuse, improper installation, improper or inadequate maintenance, hostile environmental effects and unauthorized repairs/modifications.

We reserve the right to change materials or design if, in our opinion, such changes will improve our product. Abuse, repair by an unauthorized person, or use of non-CM replacement parts voids the guarantee and could lead to dangerous operation. For full Terms of Sale, see Sales Order Acknowledgment. Also, refer to the back cover for Limitations of Warranties, Remedies and Damages, and Indemnification and Safe Operation.

UNPACKING

After opening the carton, the hoist should be carefully inspected for damage which may have occurred during shipment or handling. Check the hoist frame for dents or cracks and inspect the load chain for nicks and gouges. If shipping damage has occurred, refer to the packing list envelope on the carton for claim procedure.



WARNING

Operating a unit with obvious external damage may cause load to drop and that may result in personal injury and/or property damage.

TO AVOID INJURY:

Carefully check unit for external damage prior to installation.

OPERATING INSTRUCTIONS

After mounting and before placing in service, check the hoist for proper operation. Before operating the 3, 5, and 10 ton units, make sure that all strands of chain are straight and have no twists (due to capsized hook). If the chain is twisted, reverse capsize. To operate the hoist, pull on the hand chain as indicated below.

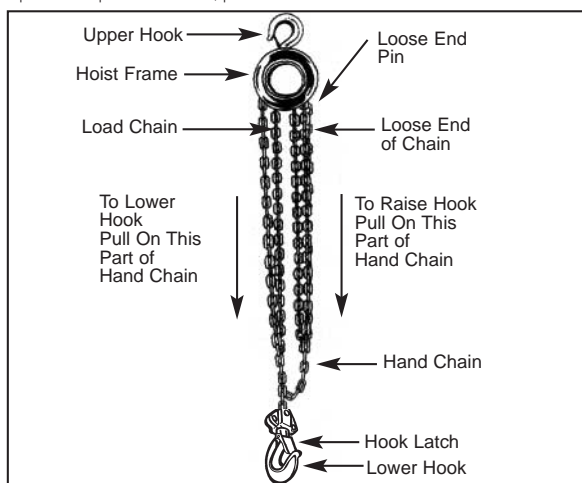

Operate the hoist with no load and then a light load of approximately 50 pounds (23 Kg.) times the number of load supporting chains to make sure it operates properly and the brake holds the load when the hand chain is released; then operate with a rated load as shown on the capacity plate.



WARNING

Operating the 3, 5, and 10 ton hoists in the lifting direction with the hook block in contact with the frame and/or hoist hanger may break the chain and allow the load to drop.

TO AVOID INJURY:

Stop operating in the lifting direction when the hook block contacts the hoist frame and/or hanger, as noted by sudden increase in hand chain pull or tipping of the hook block.

SAFETY PROCEDURES

1. The hoist must always be rigged to lift in a straight line from hook to hook. The hoist must always be free to swivel on the upper hook. Under no condition should the hoist frame be allowed to bear on any support when in use as this would cause bending of the hook or frame and damage the unit.
2. When preparing to lift or move a load, be sure that the attachments to both hooks are firmly seated in the saddles of the hooks. Avoid off center loading of any kind especially loading on the tip of the hook. Also observe that the chain hangs straight (without twist) from hoist to lower hook.
3. When lifting, raise the load only enough to clear the floor or support, and check to be sure brake will hold load and that attachments to the load are firmly seated. Continue the lift only after you are assured the load is free of all obstructions.
4. Do not load beyond the rated capacity of the hoist. Rated capacity can be achieved with the following hand chain pulls:

Hoist Rated Load Tons(Kg.)	Hand Chain Pull To Lift Rated Load Pounds (Kg.)
1/2 (500)	53 (25)
1 (1000)	77 (35)
2 (2000)	82 (37)
3 (3000)	65 (30)
5 (5000)	105 (48)
10 (10,000)	109 (50)

Since these hand chain pulls can easily be applied by one person, under no circumstances should more than one person operate the hoist hand chain. Overloading can cause immediate failure of some load carrying parts or result in damage causing future failure at less than rated capacity. When in doubt, use the next larger capacity CM hoist.



WARNING

Exceeding the rated capacity of the hoist may cause load to fall.

TO AVOID INJURY:

Do not exceed the hand chain pulls specified in 4 above.

5. Do not wrap load chain around the load or bring the load in contact with the hoist. Doing this will result in the loss of the swivel effect of the hook which could mean twisted chain and a jammed liftwheel. The chain could be damaged at the hook.
6. Stand clear of all loads and avoid moving a load over the heads of other personnel. Warn personnel of your intention to move a load in their area.
7. Do not leave the load in the air unattended.
8. Do not lower the hook to a point where the chain becomes taut between the liftwheel and loose end pin.
9. Do not run the lower hook block into the hoist frame. Frame and/or chain guide damage may result.
10. The hoist has been designed for manual operation only.



WARNING

Power operation may result in structural damage or premature wear that may cause a part to break and allow the load to fall.

TO AVOID INJURY:

Operate Series 622 Hoists using hand power only.

11. Do not use this or any other overhead materials handling equipment for lifting persons.
12. Do not allow the load to bear against the hook latch. The latch is to help maintain the hook in position while the chain is slack before taking up slack chain.



WARNING

Allowing the load to bear against the hook latch and/or hook tip can result in loss of load.

TO AVOID INJURY:

Do not allow the load to bear against the hook latch and/or hook tip. Apply load to hook bowl or saddle only.

13. Never operate the hoist when flammable materials or vapors are present. Sharp contact between metal parts can produce sparks that can cause a fire or explosion.
14. STAY ALERT! Watch what you are doing and use common sense. Do not use the hoist when you are tired, distracted or under the influence of drugs, alcohol or medication causing diminished control.

MAINTENANCE

INSPECTION

To maintain continuous and satisfactory operation, a regular inspection procedure must be initiated so that worn or damaged parts can be replaced before they become unsafe. The intervals of inspection must be determined by the individual application and are based upon the type of service to which the hoist will be subjected. The inspection of hoists is divided into two general classifications designated as "frequent" and "periodic".

Frequent Inspections:

These inspections are usually visual examinations by the operator or other designated personnel. The frequent inspections are to be performed daily or monthly and shall include the following items:

- a. Braking mechanisms for evidence of slippage — daily.
- b. Load Chain for lubricant, wear, damaged links or foreign material — daily. See below.
- c. Hooks for damage, cracks, twists, latch engagement and latch operation — monthly. See below.

Any deficiencies noted are to be corrected before the hoist is returned to service.

Periodic Inspections:

These are visual inspections by an appointed person who makes records of apparent external conditions to provide the basis for a continuing evaluation. For normal service, the periodic inspections are to be performed yearly and for heavy service, the periodic inspections are to be performed semi-annually.

Due to the construction of the hoist, it will be necessary to partially disassemble the unit to perform the periodic inspections. The periodic inspections are to include those items listed under frequent inspections as well as the following:

- a. Chain for excessive wear or stretch. See below.
- b. Worn, cracked or distorted parts such as hook blocks, hoist hanger, chain guide, stripper, loose end pin, shafts, gears, hook collar and bearings.
- c. Inspect for wear on the tip of the pawl, teeth of the ratchet and pockets of the liftwheel and handwheel.
- d. Loose or missing bolts, nuts, pins or rivets.
- e. Inspect brake components for worn, glazed or contaminated friction discs and scoring of the handwheel hub, ratchet and friction hub. Replace friction discs if the thickness is less than 0.044 in. (1.12 mm) on 1/2 & 1 ton units and 0.059 in. (1.50 mm) on 2, 3, 5 and 10 ton units.
- f. Corroded, stretched or broken pawl spring.
- g. Free movement of the pawl on the pawl stud. Also, apply a thin coat of lubricant to the pawl stud (see page 6) before reassembling the unit.

- h. Hooks — dye penetrant, magnetic particle or other suitable crack-detecting inspections should be performed at least once a year, if external conditions indicate there has been unusual usage.

Any deficiencies noted are to be corrected before the hoist is returned to service. Also, the external conditions may show the need for more detailed inspection which, in turn, may require the use of nondestructive-type testing.

Any parts that are deemed unserviceable are to be replaced with new parts before the unit is returned to service. It is very important that the unserviceable parts be destroyed to prevent possible future use as a repair item and properly disposed of.

HOOK INSPECTION

Hooks damaged from chemicals, deformations or cracks or that have more than a 10° twist from the plane of the unbent hook or excessive opening or seat wear must be replaced.

Also, hooks that are opened and those that allow the latch to disengage the tip, must be replaced.

Any hook that is twisted or has excessive throat opening indicates abuse or overloading of the unit. Other load-sustaining components of the hoist should be inspected for damage.

The chart below should be used to determine when the hook must be replaced. To measure throat opening, depress the latch against the hook body as shown below.

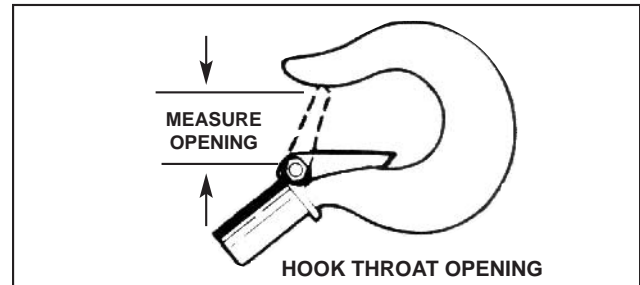

Hoist Rated Load Tons (Kg.)	Replace Hook When Opening Is Greater Than:	
	Inches	mm
1/2 (500)	1.00	25.3
1 (1000)	1.20	30.5
2 (2000)	1.43	36.8
3 (3000)	1.65	41.8
5 (5000)	2.10	53.2
10 (10000)	2.58	65.5

Also, check to make sure that the latch is not damaged or bent and that it operates properly with sufficient spring pressure to keep the latch tightly against the tip of the hook and allow the latch to spring back to the tip when released. If the latch does not operate properly, it should be replaced.

LOAD CHAIN

Cleaning and Inspection

First clean the load chain with a non-acid or non-caustic type solvent then slack the chain and make a link-by-link inspection for nicks, gouges, twisted links and excessive wear or stretching. Worn chain should be gaged throughout its entire length and replaced if beyond serviceable limits.

To determine if load chain should be continued in service, check gage lengths as indicated in figure below. Chain worn beyond length indicated, nicked, gouged or twisted should be replaced before returning hoist to service. Chain should be clean, free of twists and pulled taut before measuring. In cases where the wear is localized and not beyond serviceable limits, it is sometimes possible to reverse the load chain, end for end, and allow a new section to take the wear. Proper installation of the load chain is covered in section on Reeving Load Chain (page 7).

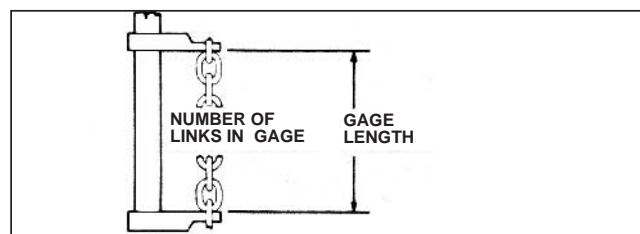

Hoist Rated Load Tons (Kg.)	Chain Stock Diameter In. (mm)	No. of Links to Gage	Max. Length Allowable for Used Chain In. (mm)
½ (500)	0.197 (5)	11	7.031 (178.6)
1 (1000)	0.236 (6)	11	8.531 (216.7)
2-10 (2000-10000)	0.394 (10)	11	14.125 (358.7)
Hand Chain	0.194 (4.9)	15	14.812(376.2)

Note that worn chain can be an indication of worn hoist components. For this reason, the hoist's chain guide roller and liftwheel should be examined for wear and replaced as necessary when replacing worn chain.

Also, load chains are specially heat treated and hardened and should never be repaired.



WARNING

Using other than CM-supplied load chain may cause the chain to jam in the hoist and/or allow the chain to break and the load to drop.

TO AVOID INJURY:

Due to the size requirements and physical properties, use only CM Hoistaloy® load chain in the Series 622 Hand Hoist.

IMPORTANT: Do not use replaced chain for other purposes such as lifting or pulling. Load chain may break suddenly without visual deformation. For this reason, cut replaced chain into short lengths to prevent use after disposal.

Before returning chain to service or after replacing a load chain, lubricate liberally with Lubriplate Bar and Chain Oil 10-R (Fiske Bros. Refining Co.) or equal lubricant. Remove excess lubricant from the chain by wiping with a cloth.

HAND CHAIN

Hand chain should be cleaned, inspected and gaged in the same manner as load chain.

As received from the factory, the hand chain contains an unwelded link. This link can be placed in a vise and twisted open to facilitate changing chain length. Please note that opening and closing of the connecting link more than twice is not recommended. Also, connecting links must not be made by cutting the weld side of a standard hand chain link.

Hand chain should be assembled to handwheel free from twists with weld on vertical link facing inwards towards handwheel and weld on horizontal link facing towards the handwheel side plate.

Care must be taken to assure that there is no twist in the hand chain loop.

LUBRICATION



WARNING

The Lubricants used in and recommended for the Series 622 Hand Hoist may contain hazardous materials that mandate specified handling and disposal procedures.

AVOID CONTACT AND CONTAMINATION:

Handle and dispose of lubricants only as directed in applicable material safety data sheets and in accordance with applicable local, state and federal regulations.

Lubricate load chain with a light coat of Lubriplate Bar and Chain Oil 10-R (Fiske Bros. Refining Co.) or equal lubricant. Be sure the lubricant reaches the bearing surfaces between the links. Remove excess oil from the chain.



WARNING

Used motor oils contain unknown carcinogenic materials.

TO AVOID HEALTH PROBLEMS:

Never use used motor oils as a chain lubricant. Only use Lubriplate Bar and Chain Oil 10-R as a lubricant for the load chain.

The hoist normally requires no additional lubrication, except for periodically lubricating the load chain as indicated above or when the unit is disassembled for periodic inspections, cleaning or repairs.

The brake is designed to operate dry. Do not use any grease or lubricant on the braking surfaces. When lubricating parts adjacent to the brake, do not use an excessive amount of lubricant which could seep onto the brake surfaces.



WARNING

Using any grease or lubricant on the braking surfaces will cause brake slippage and loss of load control which may result in injury and/or property damage.

TO AVOID INJURY:

Do not use any grease or lubricant on braking surfaces. The brake is designed to operate dry.

When the hoist is disassembled for periodic inspections, check the pawl for free movement and apply a light coat of WD-40 (WD-40 Co.) lubricant to the pawl stud.

When the hoist is disassembled for cleaning or repairs, the following locations should be lubricated using approximately 1 oz. (29.5mL) per hoist of Molykote BR-2-S (Dow Corning Corp.) grease or equivalent—threads of handwheel; gears; liftwheel rollers; gear bearing rollers; journals of chain guide and dead end pin; sheave wheel rollers (3, 5 and 10 ton); hook ball bearings (3 and 5 ton); hook collar journals (3 and 5 ton); dead end stud (3, 5 and 10 ton); bearing surface of hook knob (10 ton); hook block pin (10 ton); and hanger pin (10 ton).

NOTE: To assure extra long life and top performance, be sure to lubricate the various parts of the hoist using the lubricants specified above. If desired, these lubricants may be purchased from CM. Refer to pages 8 and 10 for information on ordering the lubricants.

DISASSEMBLY

Two points of caution to be observed in disassembly are:

- Loose rollers and bearing balls are used in various locations in the units. Care must be taken so as to not lose or misplace these since they may drop from the unit as the various parts are disassembled. The number of rollers or bearing balls used are:

Hoist Rated Load Tons (Kg.)	Location	Rollers Required
1 (1000)	Intermed. Gear	12 Each End
2-10 (2000-10000)	Intermed. Gear	11 Each End
1/2 (500)	Liftwheel	33 Each End
1 (1000)	Liftwheel	30 Each End
2-10 (2000-10000)	Liftwheel	35 Each End
3-5 (3000-5000)	Sheave Wheel	29
3 (3000)	Hook	*15
5 (5000)	Hook	*16
10 (10000)	Sheave Wheel	36

*Bearing Balls

- The latch is secured to the hook (upper and lower) by a rivet. To remove the latch, it is necessary to remove the head of the rivet by grinding or drilling. For replacement of the latch, refer to paragraph 4 of the Assembly Instructions.

ASSEMBLY

Consideration must be given to the following when assembling the hoist:

- Assemble the brake components as shown below. The ratchet teeth must face as shown and engage the pawl. Do not lubricate the brake surfaces. The brake operates dry. Assemble handwheel to pinion shaft and turn handwheel to seat brake components. Assemble the pinion shaft nut to the shaft until the nut bottoms. Then back nut off at least one but not more than two flats. Insert cotter pin and bend ends to secure same.

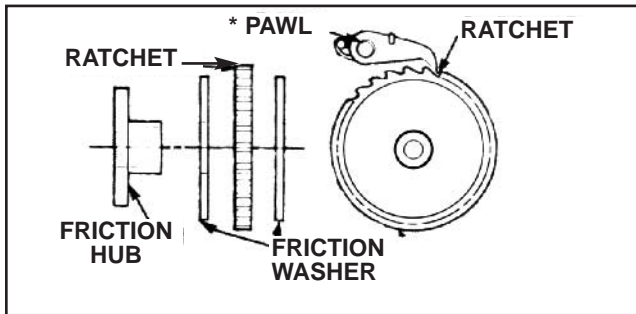

* 1/2 ton hoist has two pawls 180° apart.

- The intermediate gears (622-8) have timing marks (letter "O" stamped on one tooth). The gears must be assembled with these marks oriented as shown below.

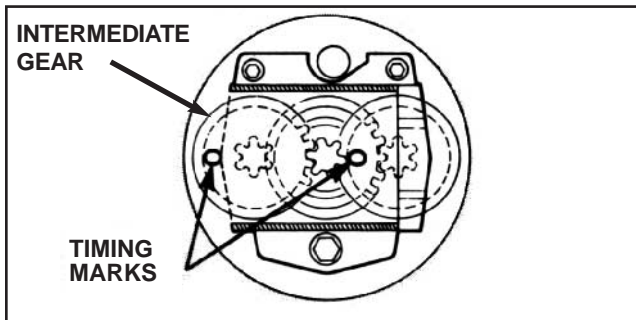

- For proper operation, the correct number of rollers must be installed at the rotating points of the liftwheel, intermediate gears, hook block sheave (3, 5 and 10 ton) and hoist hanger sheave (10 ton). Also, on the 3 and 5 ton units, the correct number of bearing balls must be installed in the hook collar to retain the hook and insure proper loading. Refer to Disassembly Instructions above for the number of rollers at these locations. Applying grease, Molykote BR - 2 - S (Dow Corning Corp.) or equal EP grease, to the rollers or bearing balls will help hold them in position during assembly.
- When assembling the latch to the hook, the end of the rivet must be peened over. When peening over the rivet, only apply enough force to form the head and retain the rivet. Excessive force will deform the latch and make the latch inoperable.

REEVING LOAD CHAIN

A. 1/2, 1, 2, 3, 5 and 10 Ton Hoists

Attach approximately 20"(508mm) of soft wire to the loose end of the chain. Pass the wire over the top of the liftwheel (622-13) and down between the liftwheel and the chain guide (622-16). Position the chain so that the first, as well as the third, link stands on edge with the weld away from the liftwheel and the second link lays flat on the liftwheel. After the chain has been started, pull hand chain in the hoisting direction until about 2 feet (0.6M) of chain has passed over the liftwheel. The wire should now be removed from the chain. Remove the cotter pin from the loose end pin (622-15) and slide the loose end pin to the side into the gear housing, leaving approximately 1/2"(12.7mm) of the pin protruding from the geared side plate (622-5). Loop the chain, making sure there are no twists, up to the loose end pin and slide the pin

through the last link of the chain. Slide the loose end pin into hole in the handwheel side plate (622-4). until the cotter pin hole is visible. Secure the loose end pin by reinstalling the cotter pin and spreading the legs of the cotter pin.

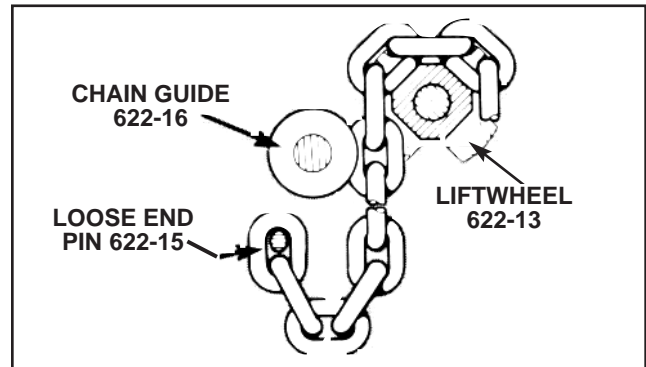

WARNING

Failure to properly install the load chain between chain guide and liftwheel may cause the chain to lift out of the liftwheel pockets and allow the load to drop.

TO AVOID INJURY:

Feed load chain between liftwheel and chain guide, as shown above, before attaching it to the loose end pin.

B. 3 and 5 Ton Hoists

The load chain must have an odd number of links. After attaching the chain to the loose end pin per above, operate in the hoisting direction until the load end of the chain is approximately 5 feet (1.5M) long. Run chain thru the hook block (first link around the sheave must stand on edge) and up to the dead end block (622-26). Secure chain to dead end block using the stud, nut and cotter pin. Refer to illustration below.

10 Ton Hoist

The load chain must have an odd number of links. After attaching the chain to the loose end pin per above, operate in the hoisting direction until the load end of the chain is approximately 20 feet (6M) long. Run the chain thru the hook block (first link around the sheave must stand on edge) around the first hook block sheave, up around the hanger sheave, down around the second hook block sheave and up to the hoist hanger. Secure the chain to the hoist hanger using the dead end stud, nut and cotter pin (622-38). Refer to Illustration below.



WARNING

On the 3, 5 and 10 ton units, twisted load chain will cause the chain to jam in the liftwheel or sheave wheels and this may break the chain and allow the load to drop.

TO AVOID INJURY:

Check each stage of reeving the chain to be sure it has no twists.

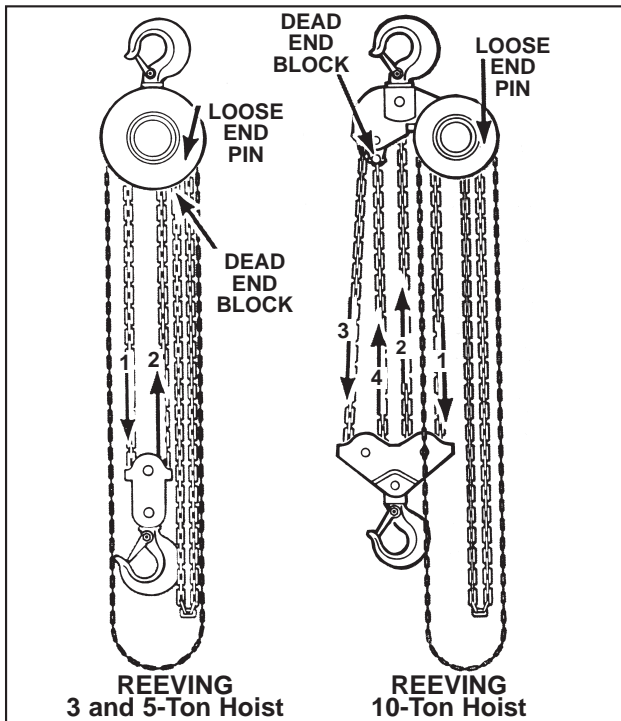

EXTERIOR FINISH

The exterior surfaces of the hoists have a durable, scratch resistant finish. Normally, the exterior surfaces can be cleaned by wiping with a cloth. However, if the finish is damaged, compatible touch-up paint can be purchased from CM. Order one case (12-12 oz.-354mL aerosol cans) of orange touch-up paint Part Number 84190. Touch-up paint is only available in case quantities. See below for ordering information.

RECOMMENDED SPARE PARTS

To insure continued operation, it is recommended that two friction washers for each Series 622 Hand Hoist in service, Key No. 622-39, be kept on hand at all times to replace friction washers that are worn, contaminated or glazed. See below for ordering information.

PREVENTIVE MAINTENANCE

In addition to the periodic inspection procedure, a preventive maintenance program should be established to prolong the useful life of the hoist and maintain its dependability and continued safe use. The program should include the periodic inspections with particular attention being paid to the lubrication of various components using the recommended lubricants.

TESTING

Before using, all altered, repaired or used hoists that have not been operated for the previous 12 months should be tested by the user for proper operation. First, test the unit without a load and then with a light load of 50 pounds (23Kg.) times the number of load supporting chains to be sure that the hoist operates properly and that the brake holds the load when the hand chain is released. Next test with a load of 125% of rated capacity. In addition, hoists in which load sustaining parts have been replaced should be tested with 125% of rated capacity by or under the direction of an appointed person and written report prepared for record purposes.

NOTE: For additional information on inspection and testing, refer to Code B30.16 "Overhead Hoists" obtainable from ASME Order Department, 22 Law

ORDERING INFORMATION

The following information must accompany all correspondence or repair parts orders.

1. Hoist Capacity
2. Serial Number -- stamped on the capacity label.

For parts orders also specify:

1. Quantity desired
2. Key Number of Part
3. Part Name
4. Part Number

When ordering replacement parts, consideration should be given to the need to replace other items, (springs, fasteners, etc.) and items that may be damaged or lost during disassembly or just unfit for future use because of deterioration from age or service.

Parts should be ordered from CM's Master Parts Depots conveniently located throughout the United States and Canada. Refer to the inside of the front cover of this manual to locate the Master Parts Depot nearest you.



WARNING

Using "commercial" or other manufacturer's parts to repair the CM Series 622 Hoist may cause load loss.

TO AVOID INJURY:

Use only CM supplied replacement parts. Parts may look alike but CM parts are made of specific materials or processed to achieve specific properties.

**SERIES 622 HAND HOIST
PARTS LIST**

KEY NO.	NO. REQ'D	PART NUMBER	PART NUMBER						
			Rated Load—Tons (Kg.)						
			1/2 (500)	1 (1000)	2 (2000)	3 (3000)	5 (5000)	10 (10000)	
622-1	1	Handwheel Cover with Studs	22910	22791	22812				
622-2	1	Handwheel	22911	22792	22813				
622-3	1	Brake Set (2 Friction Washers, Ratchet and Hub)	22912	22793	22814				
622-4	1	Handwheel Side Plate (includes Bearing Race, Pawl and Pawl Spring)	22913	22794	22925	22931	22935		
622-5	1	Geared Side Plate (includes Bearing Race, 2 Bushings and 3 Studs. 2 Roller Shield Washers also provided for 2, 3, 5 and 10 Ton)	22914	22795	22926	22932	22936		
622-6	1	Main Hardware Set (2 Gear Cover Nuts, 3 Handwheel Cover Nuts and Lockwashers, 6 Side Plate Nuts and Lockwashers)	22775	22796	22817				
622-7	1	Gear Cover with Studs	22915	22797	22818				
622-8	1	Gear Set	22916	22798	22819				
622-9	1	Gear Set Roller Kit (48 Rollers for 1-Ton, 44 Rollers for 2, 3, 5 and 10 Ton)	—	22799	22820				
622-10	1	Pinion Shaft	22917	22800	22821				
622-11	1	Pinion and Liftwheel Hardware Kit (Pinion Shaft Nut, Cotter Pin and Liftwheel Snap Ring)	22918	22801	22822				
622-12	1	Liftwheel Roller Kit (66 Rollers for 1/2 Ton, 60 Rollers for 1 Ton, 70 Rollers for 2, 3, 5 and 10 Ton)	22781	22802	22823				
622-13	1	Liftwheel (includes 2 Bearing Races)	22919	22803	22824				
622-14	1	Stripper	22920	22804	22825				
622-15	1	Loose End Pin (includes 2 Cotter Pins)	22921	22805	22927				
622-16	1	Chain Guide Roller	22922	22806	22827				
622-17	1	Upper Hook Assembly (includes Hook with Latch, Hook Block, Clevis Pin and Cotter Pin for 1/2, 1 and 2 Ton; Hook with Latch, Hook Block, Bearing Balls and Set Screw for 3 and 5 Ton)	22923	22807	22830	22836	22847	—	
622-18	1	Lower Hook Assembly (includes Hook with Latch, Hook Block, Screw, Nut and Cotter Pin)	22787	22808	22831	—	—	—	
622-19	2	Latch Kit (Latch, Spring and Rivet)	22928	22929	22930	22933	22934	22937	
622-20	1	Gear Cage with Bushings (includes 2 Roller Shield Washers for 2, 3, 5 and 10 Ton)	22924	22810	22829				
622-21	-	Load Chain (Specify Lift or Length Required.)	85834	85959	85960				
622-22	-	Hand Chain (Specify Lift or Length Required.)	85832						
622-23	1	Warning Tube	946735						
622-24	1	Label Set (Capacity and Warning Labels and 8 Drive Screws)	22603	22604	22608	22609	22610	22611	
622-25	1	Hand Chain Connecting Link	661019						
622-26	1	Dead End Kit (includes 2 Anchor Plates, Stud, Nut and Cotter Pin)	—	—	—	22839	—		
622-28	1	Sheave Shaft	—	—	—	22841	—		
622-29	1	Sheave Wheel	—	—	—	22842	—		
622-30	1	Sheave Shaft Hardware Kit (29 Rollers and 2 Snap Rings)	—	—	—	22843	—		
622-31	1	Lower Hook Assembly (includes Hook Block, Hook with Latch, Bearing Balls, Set Screw and 2 Snap Rings)	—	—	—	22844	22850	—	
622-36	1	Hoist Hanger Kit (Hanger Pin and 2 Cotter Pins)	—	—	—	—	—	22864	
622-38	1	Dead End Kit (Stud, Nut and Cotter Pin)	—	—	—	—	—	22866	
622-39	2	Friction Washer	22867	22868	22869				
622-40	1	Hoist Hanger Assembly (includes Hanger, Sheave Wheel, Hook with Latch, Hook Block, Dead End Anchor, Shafts and Snap Rings)	—	—	—	—	—	22938	
622-41	1	Lower Hook Block Assembly (includes Hook Block, Hook with Latch, Sheave Wheels, Shafts and Snap Rings)	—	—	—	—	—	22939	

622-40, 10 Ton Hoist Hanger Assembly. Except for Latch Kit, Hoist Hanger Kit and Dead End Kit, individual parts are not available for repairs.

NOTE: Metric Tools Required for Fasteners.

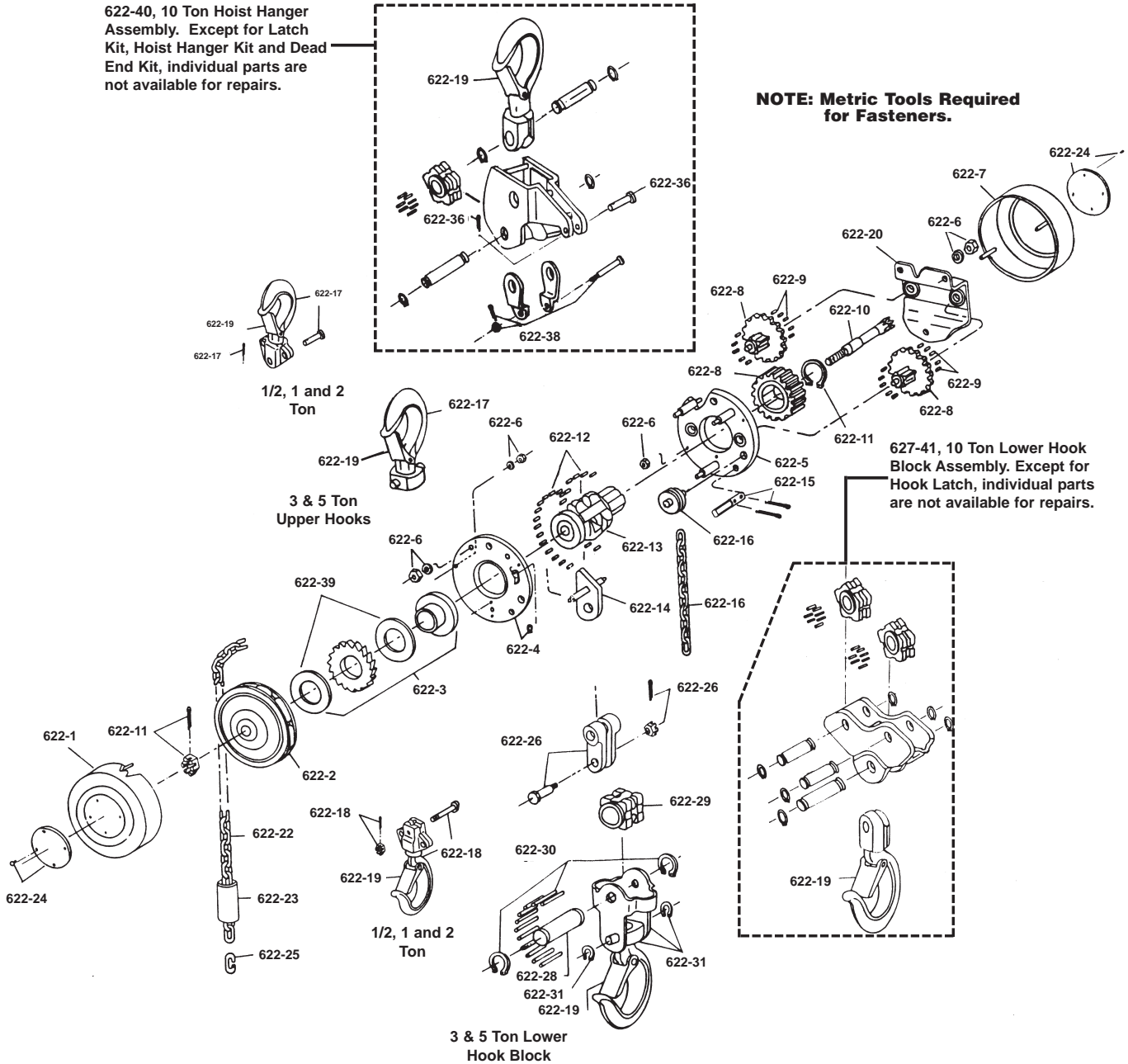

627-41, 10 Ton Lower Hook Block Assembly. Except for Hook Latch, individual parts are not available for repairs.

Series 622 Hand Hoist Exploded View

PART NUMBERS FOR PACKAGED LUBRICANTS Used in the Series 622 Hand Hoists (Refer to page 6 for Lubrication Instructions)		
Lubricant Usage	Type of Lubricant	Part Numbers and Packaged Quantities of Lubricants
Gears, Rollers of Liftwheel and Gear Bearings	Grease (Molykote BR-2-S or Equal)	28606 - 1/2 lb. (.23Kg.) can 28618 - 1 lb. (.46Kg.) can
Pawl Stud	Oil (WD-40 or Equal)	Obtain locally—not stocked by CM
Load Chain	Oil (Lubriplate Bar and Chain Oil 10-R or Equal)	28608 - 1 pint (.5L) can 28619 - 1 gal. (3.8L) can