



EDITION  
**2022**

# PART OF YOUR **RIDE**

THE PEOPLE  
BEHIND THE BRAND

> [more on page 8](#)

WATERPROOF  
TANK BAGS

> [more on page 56](#)

TRAX  
TOOLBOX

> [more on page 151](#)

**SW-MOTECH**



# EDITORIAL

## **AFTER 2020 HAD ALREADY PRESENTED US WITH UNEXPECTED CHALLENGES, 2021 WAS A LOT DIFFERENT THAN BEFORE.**

The Covid-19 pandemic continues to affect our everyday work - not only when it comes to masks, testing and vaccines. The delivery of raw materials and container freight has also become a real adventure. Freight costs have skyrocketed to unimaginable heights and raw materials such as aluminum are often not available in the quantities ordered. As a result, items were and are unfortunately not available for several weeks. That hurts us just as much as it hurts you as a customer. By the way, I don't feel any different about it myself: I recently wanted to order new tires for my motorcycle and was disappointed to find that the tires won't be available until spring 2022.

Regardless of all the difficulties that we're currently facing and trying hard to solve, we'll of course continue to work on developing good and innovative products for our favorite hobby. There's also exciting news for the 2022 season: hopefully you too will get excited about our new waterproof Sysbags.

Unfortunately, Corona continues to keep us busy. Nevertheless, I hope that we will see each other again in 2022 at numerous trade fairs and finally also at our Open House here in Rauschenberg. I am especially looking forward to that and it would be great to welcome you back in June.

All the best from Rauschenberg and happy riding!

Jörg Diehl, general management

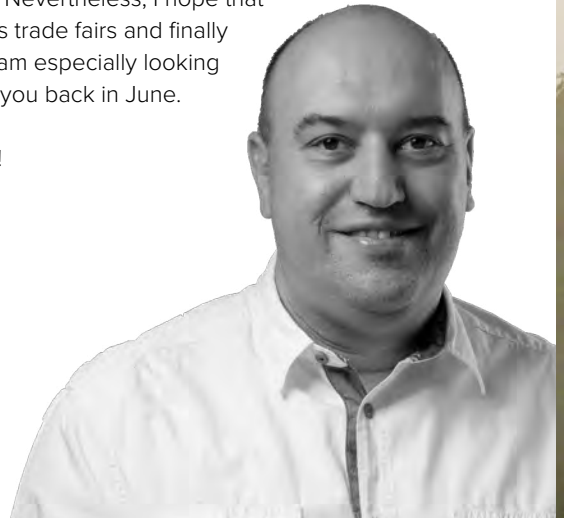

## SCAN ME

**YOU WANT TO LEARN MORE ABOUT OUR PRODUCTS? THEN WATCH OUR VIDEOS OR CLICK DIRECTLY TO OUR ONLINE STORE.**

You can find detailed videos about many of our products and bikes on our YouTube channel. Wherever you see a QR code, you'll find more background information. Just scan it with your smartphone or tablet and you're directly at the right video or product.



**INTRO 8**

LUGGAGE 40

TANK BAGS 43

SADDLEBAGS / SIDE BAGS 72

TAIL BAGS 95

SIDE CASES 133

TOP CASES 157

RACKS 167

**SAFETY 176**

**PROTECTION 190**

**ERGONOMICS 216**

**NAVIGATION 234**

**GEAR SHOP 246**



**PRO TANK BAGS**

**48**

CRASH BARS

**194**



**SYSBAGS WP**  
**76**



**PRO TAIL BAGS**  
**96**

**ENGINE GUARDS**  
**204**

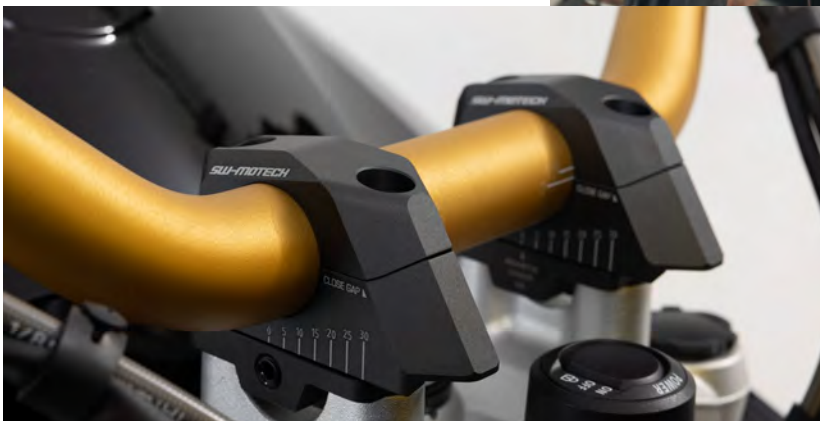

**VARIABLE BAR BACKS**  
**226**



# WHAT DOES PREMIUM ACTUALLY MEAN?

**ACCORDING TO THE DICTIONARY, PREMIUM MEANS „OF EXTRA HIGH, THE BEST QUALITY“. THE TERM GOES BACK TO THE LATIN WORD PRAEMIUM – REWARD.**

We can identify with both, even if the term is used in a very inflationary way nowadays. We always pay attention to the best, extra high quality and our products reward you with their well thought-out properties. Enough self-praise, because no one really wants to hear that. Let's take a look at how much time, brain power and sweat is put

into a crash bar, for example: we have the latest motorcycle models in our workshop every week. Our engineers check whether a crash bar can be built directly on the motorcycle. What attachment points are there on the engine or on the frame? What kind of shape does the bike have, what about the tilt angle? With a strong sense of proportion and even more experience, the first tubes are bent and fixed to mounting plates with preliminary welding points and then to the motorcycle itself.

We develop the crash bars directly on the vehicle so it fits and looks good



### A SENSE OF PROPORTION AND EXPERIENCE

Then our team's design engineers examine the result. Sometimes the attachment points on the right and left are not in the same position. Then the curvature or angle of the tube has to be adjusted again on one side. Only when both sides are symmetrical and the bracket fits the shape of the motorcycle properly do we take it to the next step:

The first prototypes are welded from steel tubing with a diameter of 22 or 27 mm and a wall thickness of 2.5 mm. It's important to pay attention to the correct sequence in which the individual tube sections are welded together. That's because the steel heats up during welding and can deform. Adhering to the welding sequence prevents material distortion and ensures the crash bars' exact fit. All information is made note of on the manufacturing protocol of the welding device and applies to series production.

coated bar can handle being blasted with salt water vapor for a whole month before the first traces of rust become visible.

### IT'S A FIT!

The finished crash bar is checked again by our quality assurance department: does it fit the test device? Can it be screwed together without tension or difficulty? If everything fits, then it's packed together with all the necessary mounting material and sent to the customer. In addition, there are illustrated assembly instructions in German and English for each model, which describe each step of the assembly process in detail and list all components.

We photograph and film the finished crash bar on the motorcycle - that's how you can get a good picture of what it looks like on your bike. And if you're convinced, we'd be happy to send you one!

### FIRST SERIES

The first series is manufactured in our Czech plant or on site in Rauschenberg and then goes to the powder coating stage. Before a second coating, the steel tube is chemically pre-treated and blasted. This increases the surface of the steel and enables the paint to adhere better to the metal. This also protects the crash bar from rust. According to our in-house tests, the powder-



Solid tubular steel is the perfect material for our crash bars



### **A LONG MATURATION PROCESS**

With textile products such as tank bags and tail bags, the process is completely different, but here too there are many steps: from brainstorming to a high-quality, finished product. It always starts with an idea, a hint from customers or the obvious need to revise a product because the market demands something new.

### **DESIGN AND FUNCTION**

For us, the optimal combination of good looks and high functionality is on the forefront of development. Sophisticated functions, outstanding manageability and a high level of robustness that defies the most adverse conditions, paired with an appealing design are, for us, the key factors that make a product a premium product. This was also a must for our new waterproof SysBags: a waterproof bag that looks good, offers sufficient storage, is lightweight and can be used with existing SW-MOTECH side carriers.



### **IN THE BEGINNING THERE WAS THE DRAWING**

But how does the process from the idea to the finished bag work? First of all, there are our colleagues in the design department who combine all the functional requirements and depict them in the form of drafts and initial drawings. After that, the first production data and product samples are created from the drawings together with specialized material suppliers and manufacturing companies. Our long-term partnership with these companies helps us ensure an effective development process.

### **PING-PONG**

Further development is a ping-pong game lasting several months between the manufacturing company, supplier, developer and project management. The development team checks the first samples: do the seams fit? Are the planned bag compartments large enough? Are the buckles and zippers easy to use - even when wearing motorcycle gloves? At this point improvements are made and other players come into play: the purchasing department takes care of the procurement of the right textiles and raw materials in sufficient quantities. Quality assurance checks the delivered materials with extensive testing procedures. These quality assurance tests simulate long-term, intensive use of materials. In this way we can guarantee that the product will also meet all requirements once passed down to the customer.

### **FINALLY READY FOR THE MARKET**

It often takes a year or more before we finally present a new bag after extensive development work at the major EICMA trade fair in Milan. For months, colleagues in development, purchasing, quality assurance, marketing and sales have invested many hours of work in order to be able to offer you a high-quality product that is well thought out, down to the last detail. It usually takes another three to four months, during which the bag makes its way to our warehouse, before you can buy the bag in our online shop or in stores. After that you can finally use the finished result on your own motorcycle and hopefully have a lot of fun with it.



[Discover more about SW-MOTECH!](#)





# NEW PRODUCTS 2022

## SYSBAGS WP

The three new SysBag WP models are your reliable companions for uncompromising motorcycle adventures. Thanks to careful material selection and elaborate workmanship, all three bags are completely waterproof.

[> more on page 76](#)



## PRO WATERPROOF TANK BAGS

Even more choice in 100% waterproof tank bags as we add two more models to our PRO WP series:

The PRO City WP is the perfect companion for all touring enduros with a sloping tank, mounting on the PRO tank ring.

The PRO Cross WP is a waterproof strap tank bag that can be placed on almost any motorcycle.

[> more on page 59 & 61](#)

## TRAX TOOLBOX

Bigger, more durable, more practical - our new TRAX Toolbox is the perfect storage place for essential travel companions and fits almost any motorcycle. Like the TRAX side cases, it is available in silver anodized or black powder-coated.

[> more on page 149](#)



## VARIABLE BAR BACKS

A small accessory with many refinements: The variable bar backs made of milled and anodized aluminum allows individual adjustment of the handlebar - available in three different colors.

[> more on page 226](#)



[Video with all new products on YouTube!](#)

# ADVENTURE

## WATERPROOF SOFT LUGGAGE



### 95 LITERS

- PRO City WP tank bag – 15 liters
- Sysbag WP L – 2 x 27 - 40 liters

**FOR ANYONE ANYWHERE, NO MATTER THE WEATHER: WATERPROOF GEAR FOR ADVENTURERS AND DISCOVERERS WHO WANT TO ENJOY DRY PANTS AND A WARM FIRE IN THE EVENING AND ARE NOT AFRAID OF RAIN DURING THE DAY.**

The soft and waterproof new SysBag WP side bag will accompany you through the rain of Scotland and the rivers of Alaska. In the event of a fall, the soft bag cushions impact and even if the bag does land in the river – the contents remain dry.

You can also take your camera equipment with you. The Pro City WP with its large storage offers waterproof protection for a camera or drone.

## LET'S GO ON AN ADVENTURE!



Robust side cover made of Hypalon with MOLLE system



The overlapping lid protects from water



[Discover more on our YouTube channel!](#)

# ADVENTURE

## ALUMINUM CASES FOR THE LONG TRIP



### 170 LITERS

- PRO GS tank bag – 16 - 20 liters
- TRAX aluminum case L – 45 liters
- TRAX aluminum case M – 37 liters
- TRAX top case – 38 liters
- TRAX accessory bag – 2x 15 liters

**WITH OUR TRAX ALUMINUM CASES YOU CAN GO ON A LONG JOURNEY AND YOUR LUGGAGE WILL ARRIVE AT ITS DESTINATION SAFELY.**

Your belongings are well protected from damage in the three robust aluminum cases. Dust and water are securely kept out. When you arrive at your destination, you can leave the suitcase on the bike, secure it with a lock and take out the contents quickly and easily using the practical inner bag.

The PRO GS tank bag with its two spacious outer pockets offers even more storage. Everything you need on the go is quickly at hand: water bottle, energy bar, cell phone, battery and camera. The tank bag can be quickly and easily attached to and removed from the PRO tank ring.

## A LOT OF SPACE



TRAX Toolbox – the best place for your tools



Accessory bag TRAX M/L – even more waterproof storage space

# STREET

## COMMUTING WITH THE NAKED BIKE



### 39 LITERS

- PRO Micro tank bag – 3 - 5 liters
- PRO Rearbag tail bag – 22 - 34 liters

**THE MT-07 IS A PERFECT MOTORCYCLE FOR THE DAILY COMMUTE TO WORK: WITH IT YOU HAVE NO STRESS IN TRAFFIC JAMS AND ALREADY FUN ON THE MORNING RIDE.**

The PRO daypack with a capacity of up to nine liters transports your water bottle, a few chocolate bars and your valuables to their destination and allows you easy reach.

At the rear you can stow your laptop in the PRO Rearbag – along with the thick sweater that you don't need in the afternoon on the way home. You take a few extra curves and arrive home in a good mood at the end of the day.



The PRO Rearbag tail bag - quick attachment with the patented lashing hook

## THE CITY IS YOURS



PRO Micro tank bag - space for wallet and smartphone



[Discover more on our YouTube channel!](#)

# STREET

## TRAVELLING WITH THE NAKED BIKE



### 48 LITERS

- PRO Daypack tank bag – 6 - 8 liters
- PRO BLAZE system – 30 - 40 liters

**FOR A MULTI-DAY TOUR, YOU CAN QUICKLY CONVERT THE MT-07 INTO A TOURING MOTORCYCLE: SIMPLY ATTACH A LARGER TANK BAG AND OFF YOU GO.**

The PRO Daypack with a capacity of up to eight liters transports your water bottle, a few chocolate bars and your valuables to their destination and allows you easy reach.

Your change of clothes for the evening fits in the back of the PRO BLAZE saddlebags. With a volume of up to 40 liters, they offer enough space for pants, sweaters, shoes and everything else you need to take with you when you travel. The good thing about it: you can simply remove the support arms from the bags following your tour and your naked bike is ready for your next sporty ride.

## READY FOR THE RIDE



The support arms can be easily removed



Frame crash pads - protection for the engine in case of crashes

# CRUISER

## SIDE CASES FOR THE WEEKEND



### 40.5 LITERS

- Legend Gear magnetic tank bag  
LT1 – 3 - 5.5 liters
- Legend Gear side case  
LH1 – 19.5 liters
- Legend Gear side case  
LH2 – 25.5 liters

**THE HONDA CMX1100 REBEL IS PERFECT FOR CRUISING AND THANKS TO ITS DCT IT'S ALSO A RELAXED COMPANION FOR LONGER TOURS.**

In addition, SW-MOTECH offers LH side bags from the Legend Gear series that can actually almost be considered cases. Thanks to the side panels reinforced with ABS plastic, the bags stay in good shape even when they're not fully loaded.

You can mount them either symmetrically with two LH1 bags or with a small LH1 on the right over the exhaust and a large LH2 on the left of the bike. The matching SLH side carriers are simply screwed onto the fender strut and are barely noticeable. So you can cruise in style, even without luggage.

## LIGHT CASES FOR THE CRUISER



SLH side carrier suitable for the LH side bags



The LH side bag combines light weight with sturdy shape

# CRUISER

## RETRO STYLE FOR YOUR VACATION



### 28,8 LITERS

- Legend Gear strap tank bag  
LT2 – 5.5 liters
- Legend Gear side bag  
LC1 – 9.8 liters
- Legend Gear side bag  
LC2 – 13.5 liters

**EVEN MORE LUGGAGE OPTIONS FOR THE BIG REBEL FROM HONDA: THE VERSATILE SLC SIDE CARRIER IS FIRMLY SCREWED TO THE TAIL AND SERVES AS A MOUNT FOR THE LEGEND GEAR LC SIDE BAGS.**

Simply click these two bags made of waxed canvas fabric on to the SLC carrier - choose between two LC1 bags or a larger LC2 bag on the left side, depending on your requirements.

The LC side bags perfectly match the vintage look of the CMX 1100. You can add the LT2 strap tank bag, which goes on the tank, to your luggage system. At 5.5 liters, it's a good companion and provides space for your valuables.

## VINTAGE STYLE VACATION



Robust side carrier made of powder coated steel tube



Crash bar - protection for the engine in case of overruns and falls



# LUGGAGE

TANK BAGS	43
SADDLEBAGS / SIDE BAGS	72
TAIL BAGS	95
SIDE CASES	133
TOP CASES	156
RACKS	167







# TANK BAGS

PRO TANK BAGS	48
WATERPROOF TANK BAGS	56
PRO TANK RING	62
PRO TANK BAG ACCESSORIES	64
LEGEND GEAR TANK BAGS	66
ION TANK BAGS	68



# SIMPLY BETTER.

Additional development of our tank bags has been based on feedback and suggestions from our customers. The newest generation, the PRO series has been on the market since April 2020 and the feedback so far tells us that we've hit the mark. Customers want them and the trade press has showered the bags with positive feedback. MOTORRAD magazine even awarded the PRO Daypack „Test Winner“ in their large tank bag comparison.

The PRO line offers elegant and timeless design in conjunction with durable materials and sophisticated product features: Ballistic nylon material protects the luggage against shocks, wind and weather. On the top, we have added laminated EVA material. This gives the bags a distinctive shape and, in conjunction with a MOLLE attachment, ensures a secure fit for the new smartphone and tablet mounts.

Always by your side: Thanks to their easy handling, PRO tank bags are a practical companion even during quick breaks.





Small items can be stowed quickly and easily. Accessory bags and mesh compartments provide convenient organization, while the zippered volume expansion gives you the flexibility of hauling more gear when needed.



ION, EVO or PRO. Tank ring systems that work. And if your model can't utilize a tank ring, many models are available in strap or magnet versions.

We are expanding our line of fully waterproof tank bags and now offer two new options with the PRO City WP and the PRO Cross WP.

With 19 different models to choose from, you can now pick the perfect tank bag for any ride, place it on your tank and hit the road. So simple and yet so good.



# TANK BAGS OVERVIEW

## PRO TANK BAGS

### FOR FLAT MOTORCYCLE TANKS

Our tank bags with flat bottom shape are particularly suitable for use on sporty motorcycles.

#### PRO MICRO

Total volume: 3 – 5 l

> [more on page 48](#)

#### PRO DAYPACK

Total volume: 5 – 8 l

> [more on page 49](#)

#### PRO SPORT

Total volume: 12 – 17 l

> [more on page 52](#)



### FOR CURVED MOTORCYCLE TANKS

For touring enduros and touring bikes with sloping tanks, we offer PRO tank bags in a curved shape. The exact position can be individually adjusted thanks to the guide rail of the top ring.

#### PRO CITY

Total volume: 11 – 14 l

> [more on page 51](#)

#### PRO GS

Total volume: 16 – 20 l

> [more on page 54](#)

#### PRO ENGAGE

Total volume: 7 – 10 l

> [more on page 50](#)

#### PRO ENDURO

Total volume: 12 – 15 l

> [more on page 46](#)

#### PRO TRIAL

Total volume: 13 – 18 l

> [more on page 53](#)



## WATERPROOF TANK BAGS

### ONE WP MODEL FOR ALL CASES

Whether flat or curved tank, on the PRO tank ring or attached with straps: For each motorcycle there is also a suitable waterproof tank bag.

#### PRO YUKON WP

Total volume: 6 l

> [more on page 58](#)

#### PRO CROSS WP

Total volume: 5.5 l

> [more on page 61](#)

#### PRO CITY WP

Total volume: 9 l

> [more on page 59](#)

#### PRO ENDURO WP

Total volume: 11 l

> [more on page 60](#)



## LEGEND GEAR TANK BAGS

### RETRO DESIGN ON THE TANK

The Legend Gear models are ideal for all scramblers, café racers and cruisers. The tank bags are attached via straps or powerful magnets.

#### LT1

Total volume: 3 – 5.5 l

> [more on page 66](#)

#### LT2

Total volume: 5.5 l

> [more on page 67](#)



**Shop now!**  
[sw-motech.com](http://sw-motech.com)





# PRO MICRO

Subtle and linear: The PRO Micro fits on almost any tank and securely transports small necessities like vehicle documents and valuables. Like all PRO tank bags, the Micro sits on an EVA plastic base that guarantees it will keep its shape. With the help of a zipper, the volume of the tank bag can be expanded.



## INCLUDED IN DELIVERY

PRO Micro tank bag, PRO top ring, rain cover PRO Micro, mounting material

 3 – 5 l  27.0 x 20.5 x 11.0 cm  800 g

PRO Micro tank bag BC.TRS.00.110.30000 110 €

Will it fit your motorcycle? Use the bike filter on [sw-motech.com](http://sw-motech.com)

## REQUIRED FOR MOUNTING:

The matching PRO tank ring is required for mounting onto the tank.

Only compatible with the PRO tank ring.



> [more on page 62](#)

## MATERIAL

- Tank bag top and bottom made of laminated and dimensionally stable EVA material
- Made from durable, highly UV-resistant 1680D ballistic nylon with water resistant interior coating

## FUNCTION

- Volume expansion by zipper from 3 to 5 liters
- The patented PRO tank ring gives PRO tank bags a secure hold
- Magnetic guide aid in the PRO tank ring for easy attachment
- Pre-assembled top ring guide rail for ergonomic adjustment of the tank bag
- MOLLE attachment made of stable hypalon material on the top for smartphone and tablet holders
- Reflective details for greater visibility in traffic
- Mesh compartments in the interior
- Weather protection with the supplied rain cover
- Robust carrying handle
- Cable feed-through on the front and rear
- Can be used with a cable lock or anti-theft protection



Small but mighty: the PRO Micro on a Honda CB 650 R



The Smartphone Drybag is sold separately as an accessory



# PRO DAYPACK

The universal fit makes the PRO Daypack tank bag a real all-rounder, just like the PRO Micro. However, the Daypack offers more storage with 5 to 8 liters. The Daypack is also available as a magnetic tank bag for use on steel tanks.

## INCLUDED IN DELIVERY

PRO Daypack tank bag, PRO top ring, rain cover PRO Daypack, mounting material



5 – 8 l 29.5 x 22.5 x 12.5 cm 1,000 g

PRO Daypack tank bag	BC.TRS.00.108.30000	145 €
PRO Daypack magnetic tank bag	BC.TRS.00.111.30000	140 €

Will it fit your motorcycle? Use the bike filter on [sw-motech.com](http://sw-motech.com)

## MATERIAL

- Tank bag top and bottom made of laminated and dimensionally stable EVA material
- Made from durable, highly UV-resistant 1680D ballistic nylon with water resistant interior coating

## FUNCTION

- Volume expansion by zipper from 5 to 8 liters
- The patented PRO tank ring gives PRO tank bags a secure hold
- Magnetic guide aid in the PRO tank ring for easy attachment
- Pre-assembled top ring guide rail for ergonomic adjustment of the tank bag
- MOLLE attachment made of stable hypalon material on the top for smartphone and tablet holders
- Reflective details for greater visibility in traffic
- Mesh compartments in the interior
- Weather protection with the supplied rain cover
- Robust carrying handle
- Cable feed-through on the front and rear
- Can be used with a cable lock or anti-theft protection

## REQUIRED FOR MOUNTING:

The matching PRO tank ring is required for mounting onto the tank.

[➤ more on page 62](#)

The PRO Daypack magnetic tank bag is attached directly onto a steel tank (no tank ring required).



Easy attachment thanks to the magnetic guide



Spacious main compartment with up to eight liters of volume



# PRO ENGAGE

The PRO Engage is perfect for use on curved fuel tanks. Like all PRO tank bags, the PRO Engage is made of robust and particularly UV-resistant 1680D ballistic nylon with a splashproof inner lining.

## INCLUDED IN DELIVERY

PRO Engage tank bag, PRO top ring, rain cover PRO Engage, mounting material



 7 – 10 l  35.0 x 26.5 x 20.0 cm  1,100 g

PRO Engage tank bag

BC.TRS.00.107.30000

165 €

Will it fit your motorcycle? Use the bike filter on [sw-motech.com](http://sw-motech.com)

## REQUIRED FOR MOUNTING:

The matching PRO tank ring is required for mounting onto the tank.

Only compatible with the PRO tank ring.



> [more on page 62](#)

## MATERIAL

- Tank bag top and bottom in laminated, dimensionally stable EVA material
- Made from durable, highly UV-resistant 1680D ballistic nylon with water resistant interior coating

## FUNCTION

- Volume expansion by zipper from 7 to 10 liters
- The patented PRO tank ring gives PRO tank bags a secure hold
- Magnetic guide aid in the PRO tank ring for easy attachment
- Pre-assembled top ring guide rail for ergonomic tank bag adjustment
- MOLLE attachment made of stable hypalon material on the top for smartphone and tablet holders
- Reflective details for greater visibility in traffic
- Mesh compartments in the interior
- Weather protection with the supplied rain cover
- Robust carrying handle
- Cable feed-through on the front and rear
- Can be used with a cable lock or anti-theft protection



Ideal for steeply sloping fuel tanks: the PRO Engage on the BMW F900 XR

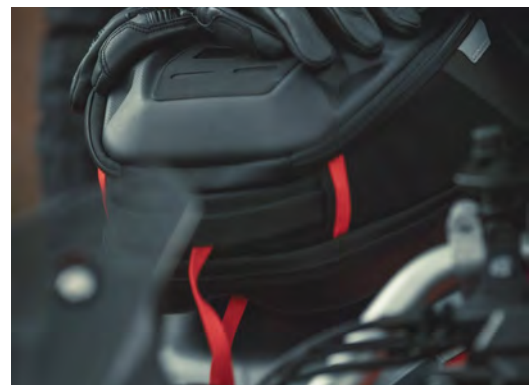

The tank bag is detached from the tank ring using the pull cord

# PRO CITY

The PRO City was developed for adventure bikes and other motorcycles with steeply sloped fuel tanks. Although the tank bag offers storage up to 14 liters, the narrow shape won't interfere with your bars, even when the bag is fully packed. Two outer pockets provide additional storage.

## INCLUDED IN DELIVERY

PRO City tank bag, PRO top ring, rain cover PRO City, mounting material

 11 – 14 l  37.0 x 29.5 x 25.0 cm  1,300 g

PRO City tank bag BC.TRS.00.104.30000 200 €

Will it fit your motorcycle? Use the bike filter on [sw-motech.com](http://sw-motech.com)

## MATERIAL

- Tank bag top and bottom in laminated, dimensionally stable EVA material
- Made from durable, highly UV-resistant 1680D ballistic nylon with water resistant interior coating

## FUNCTION

- Volume expansion by zipper from 11 to 14 liters
- 2 outer pockets
- The patented PRO tank ring gives PRO tank bags a secure hold
- Magnetic guide aid in the PRO tank ring for easy attachment
- Pre-assembled top ring guide rail for ergonomic tank bag adjustment
- MOLLE attachment made of stable hypalon material on the top for smartphone and tablet holders
- Reflective details for greater visibility in traffic
- Mesh compartments in the interior
- Weather protection with the supplied rain cover
- Robust carrying handle
- Cable feed-through on the front and rear
- Can be used with a cable lock or anti-theft protection



## REQUIRED FOR MOUNTING:

The matching PRO tank ring is required for mounting onto the tank.

Only compatible with the PRO tank ring.

> [more on page 62](#)



Two outer pockets for better luggage division



# PRO SPORT

The PRO Sport is the perfect choice for sport motorcycles, thanks to its striking design and flat shape. With 12 – 17 liters, this tank bag has plenty of storage. Navigation, smartphones and tablets can be securely attached to the lid of the MOLLE system using the T-Lock holder.

## INCLUDED IN DELIVERY

PRO Sport tank bag, PRO top ring, rain cover PRO Sport, mounting material



 12 – 17 l  39.5 x 31.5 x 16.5 cm  1,400 g

PRO Sport tank bag

BC.TRS.00.101.30000

210 €

Will it fit your motorcycle? Use the bike filter on [sw-motech.com](http://sw-motech.com)

## REQUIRED FOR MOUNTING:

The matching PRO tank ring is required for mounting onto the tank.

Only compatible with the PRO tank ring.



> [more on page 62](#)

## MATERIAL

- Tank bag top and bottom in laminated, dimensionally stable EVA material
- Made from durable, highly UV-resistant 1680D ballistic nylon with water resistant interior coating

## FUNCTION

- Volume expansion by zipper from 12 to 17 liters
- 2 outer pockets
- The patented PRO tank ring gives PRO tank bags a secure hold
- Magnetic guide aid in the PRO tank ring for easy attachment
- Pre-assembled top ring guide rail for ergonomic adjustment of the tank bag
- MOLLE attachment made of stable hypalon material on the top for smartphone and tablet holders
- Reflective details for greater visibility in traffic
- Mesh compartments in the interior
- Weather protection with the supplied rain cover
- Robust carrying handle
- Cable feed-through on the front and rear
- Can be used with a cable lock or anti-theft protection



# PRO TRIAL

The PRO Trial is a great companion for long-distance touring. With its open volume expansion, the tank bag features 18 liters of storage and is particularly suitable for use on slightly curved fuel tanks. Two outer pockets provide additional storage.

## INCLUDED IN DELIVERY

PRO Trial tank bag, PRO top ring, rain cover PRO Trial, mounting material

 13 – 18 l  37.0 x 31.0 x 24.0 cm  1,600 g

PRO Trial tank bag BC.TRS.00.102.30000 220 €

Will it fit your motorcycle? Use the bike filter on [sw-motech.com](http://sw-motech.com)

## MATERIAL

- Tank bag top and bottom in laminated, dimensionally stable EVA material
- Made from durable, highly UV-resistant 1680D ballistic nylon with water resistant interior coating

## FUNCTION

- Volume expansion by zipper from 13 to 18 liters
- 2 outer pockets
- The patented PRO tank ring gives PRO tank bags a secure hold
- Magnetic guide aid in the PRO tank ring for easy attachment
- Pre-assembled top ring guide rail for ergonomic adjustment of the tank bag
- MOLLE attachment made of stable hypalon material on the top for smartphone and tablet holders
- Reflective details for greater visibility in traffic
- Mesh compartments in the interior
- Weather protection with the supplied rain cover
- Robust carrying handle
- Cable feed-through on the front and rear
- Can be used with a cable lock or anti-theft protection



## REQUIRED FOR MOUNTING:

The matching PRO tank ring is required for mounting onto the tank.

Only compatible with the PRO tank ring.

> [more on page 62](#)



The PRO Trial is the perfect companion for longer tours





Anti-theft protection for the zipper is possible

# PRO GS

The PRO GS was specifically developed for steeply sloping fuel tanks like the BMW R 1250 GS. The stable tank bag offers up to 20 liters of generous storage space. Equipped with the MOLLE system for holding the smartphone or tablet holder, the PRO GS is the perfect companion for long journeys.

## INCLUDED IN DELIVERY

PRO GS tank bag, PRO top ring, rain cover PRO GS, mounting material

 16 – 20 l  42.0 x 34.0 x 30.0 cm  1,500 g

PRO GS tank bag

BC.TRS.00.103.30000

240 €

Will it fit your motorcycle? Use the bike filter on [sw-motech.com](https://www.sw-motech.com)



## REQUIRED FOR MOUNTING:

The matching PRO tank ring is required for mounting onto the tank.

Only compatible with the PRO tank ring.



> [more on page 62](#)

## MATERIAL

- Tank bag top and bottom in laminated, dimensionally stable EVA material
- Made from durable, highly UV-resistant 1680D ballistic nylon with water resistant interior coating

## FUNCTION

- Volume expansion by zipper from 16 to 20 liters
- 2 outer pockets
- The patented PRO tank ring gives PRO tank bags a secure hold
- Magnetic guide aid in the PRO tank ring for easy attachment
- Pre-assembled top ring guide rail for ergonomic adjustment of the tank bag
- MOLLE attachment made of stable hypalon material on the top for smartphone and tablet holders
- Reflective details for greater visibility in traffic
- Mesh compartments in the interior
- Weather protection with the supplied rain cover
- Robust carrying handle
- Cable feed-through on the front and rear
- Can be used with a cable lock or anti-theft protection





# PRO ENDURO

We cannot offer tank rings for some motorcycle models, but the PRO Enduro strap tank bag impresses with its sophisticated details. When refueling your bike, simply detach the snap buckles and slide or fold the base to the side to gain access to the gas tank. The PRO Enduro strap tank bag fits like a glove on touring motorcycles with sloping fuel tanks.

## INCLUDED IN DELIVERY

PRO Enduro strap tank bag, waterproof inner bag, Adhesive protective foil

 12 – 15 l  35.0 x 31.5 x 20.0 cm  1,100 g

PRO Enduro strap tank bag BC.TRS.00.112.30000 155 €

Will it fit your motorcycle? Use the bike filter on [sw-motech.com](http://sw-motech.com)

## MATERIAL & FUNCTION

- Suitable for many motorcycle tanks.
- Waterproof tank bag with 11 liters of storage
- The top and bottom of the tank bag is made of laminated, shape-retaining EVA material
- Overlapping lid prevents water from entering
- Lid secured magnetically
- Welded body made of TPU without seams
- MOLLE attachment made of stable hypalon on the top for holding accessories like smartphone and tablet mount
- Two outer pockets made of welded hypalon with mesh compartments
- Clear compartment for smartphone or maps in inner lid
- Sealed zippers
- Robust zipper made of metal
- Reflective details for better visibility
- Robust carrying handle
- Underside made of anti-slip material



### TIP:

In order to avoid paint damage, affix the enclosed adhesive protective foil or a tank pad to the upper surface of the tank.



# THE SEARCH FOR THE 100%

For over 20 years we have been developing and producing high-quality motorcycle luggage. Throughout this time, without a doubt, the single most frequently asked question we get when presenting riders with our tank bags has been:

**„IS THIS TANK BAG 100% WATERPROOF?“**

A question that has consistently haunted us. Whether it is at a trade show, by email, over the phone with customer service or in the comments on our live streams: The „waterproof“ feature is always top of mind among motorcyclists. And with the development of the new PRO WP Tank Bags, we finally have the best possible answer to the question:.

**„YES. 100% WATERPROOF.“**

## THE HARD WAY

The road to this perfect answer was not straightforward. A look back in SW-MOTECH history reveals our first attempt at a fully waterproof tank bag, the Yukon 90, was first presented in 2014 at INTERMOT in Cologne. It was still utilizing the EVO tank ring, made of tarpaulin and was proudly presented as a world first. Heavyweight, difficult operation, relatively low volume and (subjectively) an appearance only a mother could appreciate held the market success of the Yukon 90 back. In 2018 it was put on discontinued and we also had to admit that the Yukon 90 did not meet our requirements for the geometry and appearance of a completely waterproof tank bag. Undeterred, we went back to the drawing board, the engines in the development forge started anew...



What takes a long time finally becomes tight: After intensive development work SW-MOTECH now offers four fully waterproof tank bags in different sizes

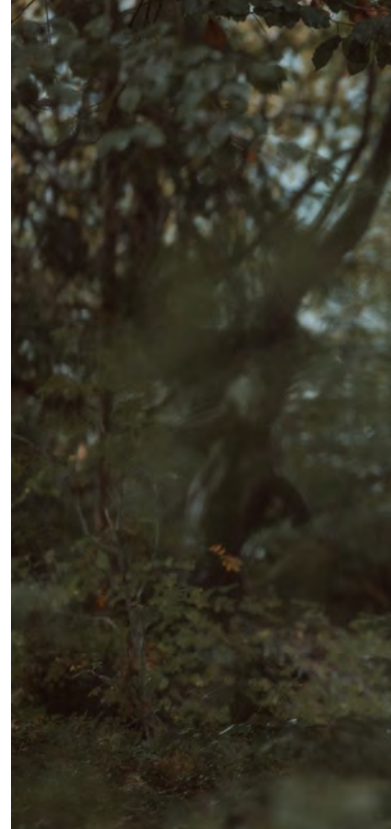





### A DETOUR CARRIES FRUITS

We first improved other things and the step from EVO to PRO followed: magnet-guided attachment on the tank ring, shape-forming EVA material, no more drilling thanks to pre-mounted guide rail on the top ring. And 100% waterproof? No. But plenty of useful door openers along the way, and so the objective after the market launch of the PRO tank bags in spring 2020 was clear: Now we need a waterproof tank bag with all the functions and in a nice design.

### TPU + EVA = WP

In the next development step, we started with the shape-forming EVA plastic used in our PRO Tank bags and added an outer lamination, creating a waterproof seal. Robust TPU material was chosen for the body which was then thermo-fitted to the EVA upper and lower sections. The end result is a tank bag with no seams, no holes and no exposed zippers.

**100% WATERPROOF.  
ANY MORE QUESTIONS?**





# PRO YUKON WP

The waterproof Yukon WP offers all the advantages of the PRO series and protects your luggage from rain and splashing water in any weather. The overlapping lid made of dimensionally stable EVA material is firmly welded to the TPU body. By welding the two plastics, the materials are seamlessly and firmly joined together – dust and water don't stand a chance.

## INCLUDED IN DELIVERY

PRO Yukon WP, PRO top ring, mounting material



 6 l  30.0 x 22.0 x 19.0 cm  1,200 g

PRO Yukon WP tank bag

BC.WPB.00.022.10000

155 €

Will it fit your motorcycle? Use the bike filter on [sw-motech.com](https://www.sw-motech.com)

## REQUIRED FOR MOUNTING:

The matching PRO tank ring is required for mounting onto the tank.

Only compatible with the PRO tank ring.



> [more on page 62](#)

## MATERIAL

- Top and bottom in laminated, dimensionally stable EVA material
- Welded body made of TPU plastic without seams

## FUNCTION

- Waterproof tank bag with 6 liters of storage
- The patented PRO tank ring gives the tank bag a secure hold
- Magnetic guide aid in the PRO tank ring for easy attachment
- Pre-assembled top ring guide rail for ergonomic adjustment of the tank bag
- Overlapping lid prevents water from entering
- Lid secured magnetically
- MOLLE attachment made of stable hypalon material on the top for smartphone and tablet holders
- Inner pocket with elastic loops and compartments
- Clear compartment for smartphone or maps in inner lid
- Sealed zippers
- Robust and lockable metal zipper
- Reflective details for greater visibility in traffic
- Robust carrying handle
- Can be used with a cable lock or anti-theft protection



# PRO CITY WP

The PRO City WP is the perfect companion for all travel enduros with a sloping tank. With a luggage volume of 9 liters, it offers a permanently dry home for all belongings—without a rain cover or an additional inner pocket. The adjustable partition in the inner compartment ensures that luggage is cleverly organized. The sturdy outer pockets are provided with waterproof zippers and are therefore also completely waterproof.

## INCLUDED IN DELIVERY

PRO City WP, PRO top ring, mounting material

9 l 35.7 x 32.1 x 20.6 cm 1,400 g

PRO City WP tank bag BC.WPB.00.024.10000 220 €

Will it fit your motorcycle? Use the bike filter on [sw-motech.com](http://sw-motech.com)

## MATERIAL

- Top and bottom in laminated, dimensionally stable EVA material
- Welded body made of TPU plastic without seams

## FUNCTION

- Waterproof tank bag with 9 liters of storage
- The patented PRO tank ring gives the tank bag a secure hold
- Magnetic guide aid in the PRO tank ring for easy attachment
- Pre-assembled top ring guide rail for ergonomic adjustment of the tank bag
- Overlapping lid prevents water from entering
- Lid secured magnetically
- MOLLE attachment made of stable hypalon on the top for holding accessories like smartphone and tablet mount
- Clear compartment for smartphone or maps in inner lid
- Sealed zippers
- Robust and lockable metal zipper
- Reflective details for better visibility
- Robust carrying handle
- Inner pocket with elastic loops and compartments
- Can be used with a cable lock or anti-theft protection



## REQUIRED FOR MOUNTING:

The matching PRO tank ring is required for mounting onto the tank.

Only compatible with the PRO tank ring.

> [more on page 62](#)



Secure hold even at high speeds



Stable lid with magnetic cap

# PRO ENDURO WP

With this waterproof strap tank bag we meet the demands of numerous customers: in the spacious inner compartment of the PRO Enduro WP the most important travel accessories can be stored. Thanks to the high-quality craftsmanship and the clever welding system, electronic devices and cameras can be transported in any weather conditions.

## INCLUDED IN DELIVERY

PRO Enduro WP strap tank bag, strap set, adhesive protective foil



11 l 42.0 x 25.0 x 23.0 cm 1,400 g

PRO Enduro WP strap tank bag BC.WPB.00.023.10000 180 €

Will it fit your motorcycle? Use the bike filter on [sw-motech.com](https://www.sw-motech.com)

## TIP:

In order to avoid paint damage, affix the enclosed adhesive protective foil or a tank pad to the upper surface of the tank.



## MATERIAL & FUNCTION

- Suitable for many motorcycle tanks.
- Waterproof tank bag with 11 liters of storage
- The top and bottom of the tank bag is made of laminated, shape-retaining EVA material
- Overlapping lid prevents water from entering
- Lid secured magnetically
- Welded body made of TPU without seams
- MOLLE attachment made of stable hypalon on the top for holding accessories like smartphone and tablet mount
- Two outer pockets made of welded hypalon with mesh compartments
- Clear compartment for smartphone or maps in inner lid
- Sealed zippers
- Robust zipper made of metal
- Reflective details for better visibility
- Robust carrying handle
- Underside made of anti-slip material



# PRO CROSS WP

The PRO Cross WP is a waterproof strap tank bag for all motorcyclists who leave nothing to chance. Thanks to the robust straps, the tank bag is under constant tension and has a tight fit. The PRO Cross WP can even be placed on small enduro machines with a narrow tank. It can be removed quickly using four quick-release fasteners, and all you need to do is loosen the two front buckles to refuel.



## INCLUDED IN DELIVERY

PRO Cross WP strap tank bag, strap set, adhesive protective foil

5.5 l 24.9 x 20.7 x 19.9 cm 900 g

PRO Cross WP tank bag BC.WPB.00.025.10000 130 €

Will it fit your motorcycle? Use the bike filter on [sw-motech.com](http://sw-motech.com)

## TIP:

In order to avoid paint damage, affix the enclosed adhesive protective foil or a tank pad to the upper surface of the tank.



## MATERIAL

- Top of the tank bag made of laminated and stable EVA
- Welded body made of TPU without seams
- Underside made of anti-slip material

## FUNCTION

- Suitable for many motorcycle tanks.
- Waterproof tank bag with 5.5 liters of storage
- Overlapping lid prevents water from entering
- Lid secured magnetically
- Welded body made of TPU without seams
- MOLLE attachment made of stable hypalon on the top for holding accessories like smartphone and tablet mount
- Sealed zippers
- Robust zipper made of metal
- Reflective details for better visibility
- Robust carrying handle
- Underside made of anti-slip material





# CLICK.

## THE PRO TANK RING

With the PRO tank ring we have made the best system even better. It combines the advantages of a mechanical snap lock with those of patented magnet technology.

Almost as if by magic, the small but powerful guide magnets direct the piece of luggage exactly to the right place. Then the spring mechanism snaps shut and the upper ring engages with a clearly audible snap. Now the lower ring securely holds the tank bag in any situation, at high speeds on the highway as well as when driving through rough terrain.



[Discover more on  
our youtube channel!](#)



# THE PRO TOP RING

At the request of many customers, we have significantly improved the positioning of the top ring: The movable top ring is already pre-assembled on the tank bag with a guide rail and does not need to be drilled.

This way, the patent pending upper ring can be individually aligned on the guide rail on the underside of the tank bag. Once the right position has been found, the top ring is screwed tight. When changing to another motorcycle, the position of the upper ring can be adjusted accordingly.



## PRO QUALITY FOR ALL

We feel the PRO tank bag and tank ring system is the most practical system on the market. To make it available for as many riders as we can, we have designed a PRO tank ring for over 770 models and counting.



# ACCESSORIES

## PRO TANK BAGS

### SMARTPHONE DRYBAG

The waterproof Smartphone Drybag fits every PRO tank bag. The holder's plastic case with clear PVC window and inner dimensions of 160 x 80 mm is suitable for almost all conventional smartphones up to 6.5 inches.

The Smartphone Drybag can be fastened to the tank bag's MOLLE system using the T-Lock holder. Once the T-Lock holder is fitted, the Smartphone Drybag can be released with a quarter turn when needed. This way the device can be removed in just one step.

BC.TRS.00.152.30000

25 €



### PRO POCKET

The PRO Pocket accessory bag is perfectly suited to transporting your valuables and travel accessories with its one liter volume. And it is also extremely versatile, because it can be attached to all PRO tank bags and tail bags with MOLLE adapters.

The built-in mesh compartments on the top and bottom improve the bag's practicality and a fastening strap with snap hook for keys is also included. The MOLLE attachment on the upper part enables the attachment of additional accessory bags.

BC.TRS.00.153.30000

45 €



#### MORE INFO ON THE T-LOCK HOLDER

This allows you to attach accessory bags quickly and easily to the MOLLE system.

[> more on page 238](#)





# TABLET DRYBAG

The waterproof Tablet Drybag is the perfect transport solution for maps and tablets on the PRO tank bags: with two supporting arms the Tablet Drybag is inserted into the MOLLE system and additionally secured to the tank bag with a rubber strap.

The tablet itself is waterproof in the plastic case with a large clear PVC window. Thus almost all devices with conventional dimensions can be used with the Tablet Drybag on your motorcycle for navigation. Alternatively, the Tablet-Drybag can also be used for conventional road maps.

BC.TRS.00.151.30000

35 €

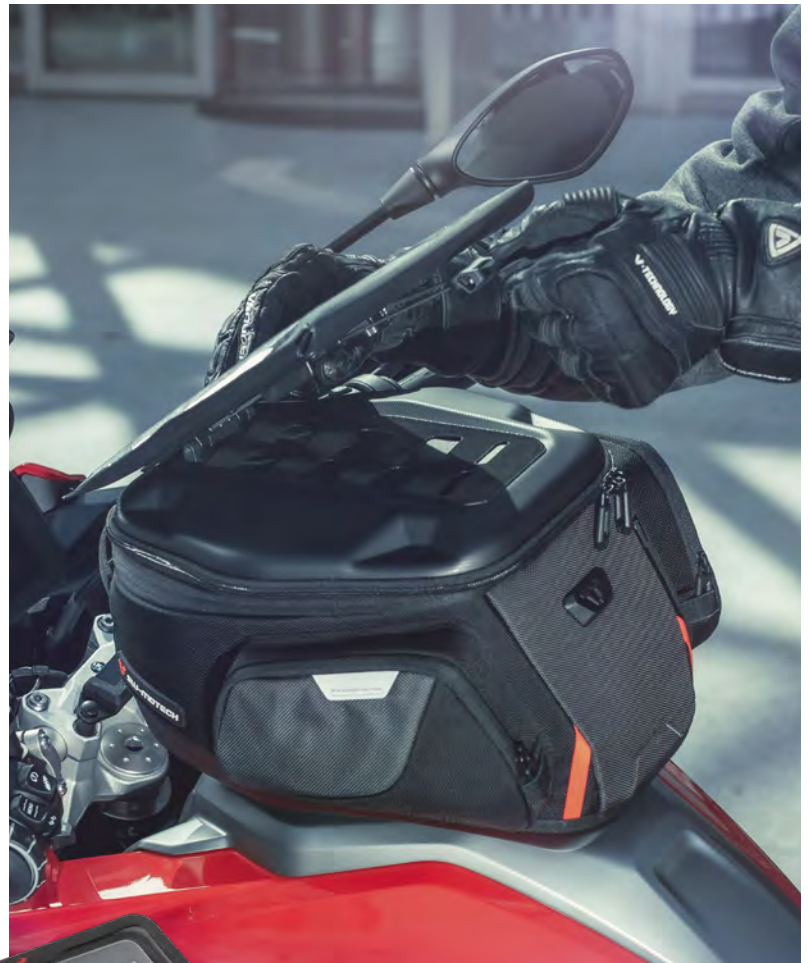

## ANTI-THEFT SYSTEM

This anti-theft kit offers a dual protection system: a security pin prevents the removal of the tank bag from the inside, and the included cable lock secures the tank bag from the outside.

TRT.00.640.20001

20 €



# MAGNETIC TANK BAG LT1

Strong magnets give the tank bag LT1 a strong hold, even on uneven surfaces. Its sophisticated base plate design allows it to be released from the tank without exerting excessive force.

## INCLUDED IN DELIVERY

Legend Gear magnetic tank bag LT1, rain cover with clear PVC window  
4 fastening straps (strap installation with non-magnetic tanks possible)



 3 – 5.5 l  25.0 x 18.0 x 10.0 cm  400 g

Magnetic tank bag LT1	BC.TRS.00.401.10000	95 €
Magnetic tank bag LT1-Black Edition	BC.TRS.00.401.10100	95 €

Will it fit your motorcycle? Use the bike filter on [sw-motech.com](http://sw-motech.com)

## TIP:

In order to avoid paint damage, affix the adhesive protective foil or a tank pad to the upper surface of the tank.



## MATERIAL

- Napalon synthetic leather and waxed canvas, water-resistant inner lining
- Coated underside

## FUNCTION

- Volume expansion from 3 to 5.5 liters
- Compatible with nearly any steel tank.
- 4 fastening straps for strap installation on non-magnetic tanks
- Weather protection with water-repellent material and waterproof rain cover with clear PVC window
- Robust carrying handle
- Cable feed-through on the front side



Magnetic tank bag LT1 brown/black

# STRAP TANK BAG LT2

The compact LT2 tank bag uses classic mounting straps with a modern feature: Two aluminium hooks make it easy to lift the bag and access the gas tank.

## INCLUDED IN DELIVERY

Legend Gear strap tank bag LT2, rain cover with clear PVC window, 2 fastening straps



5.5 l 30.0 x 18.0 x 15.0 cm 700 g

Strap tank bag LT2 BC.TRS.00.402.10000 110 €

Will it fit your motorcycle? Use the bike filter on [sw-motech.com](http://sw-motech.com)

## TIP:

Even more bags in classic retro style: you can find more LEGEND GEAR products on [pages 87 – 93 & 116 – 119](#)



## MATERIAL

- Napalon synthetic leather and waxed canvas, water-resistant inner lining
- Coated underside

## FUNCTION

- The overlapping lid protects against dirt and moisture.
- Strap for attaching accessory bags
- Weather protection with water-repellent material and waterproof rain cover with clear PVC window
- Robust carrying handle
- Cable feed-through on the front sidew



# ION ONE



The compact ION one tank bag is suitable for almost all tank shapes and is perfect for short tours. If 5 liter storage is not enough, the volume can be almost doubled with the circumferential zipper.

The ION tank bags impress with their unmistakable design and are a cost-effective alternative to the Premium tank bags in the PRO series.

## INCLUDED IN DELIVERY

ION one tank bag, ION top ring, rain cover, mounting material



 5 – 9 l  30.0 x 21.0 x 15.0 cm  700 g

ION one tank bag

BC.TRS.00.201.10001

100 €

Will it fit your motorcycle? Use the bike filter on [sw-motech.com](http://sw-motech.com)

## REQUIRED FOR MOUNTING:

For installation on the tank, the matching ION tank ring is required.

Not compatible with other tank rings.

> [more on page 71](#)



## MATERIAL

- Durable, UV-resistant 600D polyester with water-resistant inner lining
- High form stability due to EVA plastic base and padding

## FUNCTION

- Volume expansion by zipper from 5 to 9 liters
- Universal, compact shape, suitable for almost every tank
- Individual mounting of the included ION top ring for best fit
- Mesh compartment on the inside
- Integrated map holder that also supports the touch function of digital devices
- Reflective details for more safety in traffic
- Pull strap for releasing the QUICK-LOCK mechanism is secured with a snap fastener
- Practical carrying handle
- 1 splash-proof cable feed-through
- Rain cover with clear PVC window included in delivery



Volume expansion from 5 to 9 liters





Inner mesh compartment

# ION TWO

The ION two tank bag is a winner with its universal shape. Thanks to its flat base it looks especially good on sports bikes. For extra storage, the volume can be increased from 13 to 20 liters. Navigating with a map, smartphone or GPS? No problem, because the material of the integrated map holder also enables the use of touchscreen devices.

## INCLUDED IN DELIVERY

ION two tank bag, ION top ring, rain cover, mounting material

 13 – 20 l  38.0 x 26.0 x 17.0 cm  1,000 g

ION two tank bag

BC.TRS.00.202.10001

130 €

Will it fit your motorcycle? Use the bike filter on [sw-motech.com](http://sw-motech.com)

## MATERIAL

- Durable, UV-resistant 600D polyester with water-resistant inner lining
- High form stability due to EVA plastic base and padding

## FUNCTION

- Expand the volume from 13 to 20 liters using the zippers
- Individual installation of the included ION top ring for the best fit
- Mesh compartments in the interior
- Space for external DIN A4 map holder, tablet or Smartphone Drybag
- Reflective details for more safety in traffic
- Pull strap for releasing the QUICK-LOCK mechanism is secured with a snap fastener
- Practical carrying handle
- 1 splash-proof cable feed-through
- Rain cover with clear PVC window included in delivery



## REQUIRED FOR MOUNTING:

For installation on the tank, the matching ION tank ring is required.

Not compatible with other tank rings.

> [more on page 71](#)



The pull strap is secured with a push button



Embroidered SW-MOTECH silver-gray bull

# ION THREE

Just the thing for long tours! The ION three tank bag is a real storage wonder, whose already generous 15 liter volume can be expanded to 22. The shape of its underside perfectly hugs lightly curved fuel tanks – and yet thanks to the ION tank ring it does not touch the tank. The material of the integrated map holder also enables the use of touchscreen devices. The ION three tank bag also has a Velcro® patch and D-rings for attaching an optional map holder in DIN-A4 format.

## INCLUDED IN DELIVERY

ION three tank bag, ION top ring, rain cover, mounting material



 15 – 22 l  38.0 x 33.0 x 19.0 cm  1,300 g

ION three tank bag

BC.TRS.00.203.10001

140 €

Will it fit your motorcycle? Use the bike filter on [sw-motech.com](http://sw-motech.com)

## REQUIRED FOR MOUNTING:

For installation on the tank, the matching ION tank ring is required.

Not compatible with other tank rings.

> [more on page 71](#)



## MATERIAL

- Durable, UV-resistant 600D polyester with water-resistant inner lining
- High form stability due to EVA plastic base and padding

## FUNCTION

- Volume expansion with zipper from 15 to 22 liters
- Individual mounting of the included ION top ring for best fit
- 2 outer pockets, mesh compartments inside
- Space for external DIN A4 map holder, tablet or
- Smartphone Drybag
- Integrated map holder that also supports the touch function of digital devices
- Reflective details for more safety in traffic
- Pull strap for releasing the QUICK-LOCK mechanism is secured with a snap fastener
- Practical carrying handle
- 1 splash-proof cable feed-through
- Rain cover with clear PVC window included in delivery



Two outer pockets



Integrated map holder on the upper part

# ION TANK RING

The ION tank ring, made from fiberglass-reinforced polyamide, provides a secure hold for tank bags in the ION series. The ION tank bag is mounted and locked in place with a single click. The quick-release fastener is then unlocked using the pull strap. The bike-specific design of these tank rings guarantees easy mounting and a secure fit, even for off-road riding.

starting at 15 €

## MATERIAL & FUNCTION

- Made from fiberglass-reinforced polyamide
- Only for ION tank bags
- Uncomplicated installation to original attachment points in the fuel cap area
- ION tank bag, easily removable for refueling your motorcycle
- Mounting material included in delivery





# SADDLEBAGS / SIDE BAGS

<b>SYSBAG WP</b>	<b>76</b>
<b>BLAZE SADDLEBAGS</b>	<b>82</b>
<b>SIDE BAGS LH</b>	<b>86</b>
<b>LEGEND GEAR SIDE- &amp; SADDLEBAGS</b>	<b>90</b>



# WEATHER CANNOT BE PLANNED.

## DRY LUGGAGE DOES.

**THE NEW WATERPROOF SYSBAGS WP BY SW-MOTECH. UNCOMPROMISING ADVENTURE.**

### OFF TO A LIVING ADVENTURE

For many people, motorcycle adventures are so appealing, because they cannot be planned down to the last detail. Despite months of preparation, each tour can have its own surprises in store: the weather can change, routes can change, technology may not work, and encounters with other people can mess up schedules.

Whether desired or hated, whether voluntary or imposed: a certain openness towards the „unscheduled“ is in principle not wrong, since it is already included in the „scope of delivery“ of the large travel package. Moreover: isn't it the unknown terrain that tickles us, challenges us, and gives us an immediate feeling of freedom? So according to the motto: get out of the comfort zone and into where uncertainty resides?

Not quite. Because with all the unplanned factors, every motorcycle adventure also needs helpers who function reliably in the face of all adversities: the motorcycle, the instinct, the cool head and of course the equipment—regardless of the weather.

### THE NEW GENERATION OF ADVENTURE SOFT LUGGAGE

With the new edition of the SysBag family, SW-MOTECH is pursuing a clear goal: the development of soft luggage that meets the highest demands and at the same time defies all unpredictable resistance. Thanks to the careful selection of materials and elaborate workmanship, all three SysBag WP models are completely waterproof and very robust. These bags are well prepared for use out there.



Ready for uncompromising adventures: The new waterproof SysBag WP models





Uniform look on the bike:  
The SysBag WP L and the PRO City  
WP tank bag

### THE WP FAMILY IS GROWING STEADILY

After the successful market launch of the waterproof tank bags in spring 2021, the SysBags will now also be equipped with the abbreviation WP (Water Proof). The basis of all WP bags is the tried and tested TPU material: the synthetic plastic has proven to be extremely resistant in numerous tests, even after more than 100 hours of continuous rain no water penetrates the interior. And the reliability of the material also absolutely convinced us in practical use on the bike.

Analogous to the old SysBags, there are again three different sizes for the WP models, only the name has changed: Instead of 10, 15, 30, the bags will be called S, M and L in future. The largest representative is made exclusively of TPU, in The two smaller versions are made of EVA material that gives them shape.

We have also changed things and, above all, simplified things when it comes to attaching them to the motorcycle. In future, the pockets will be looped onto the associated adapter plates - no longer screwed. Once fixed, the S and M models then fit on the SLC carrier, the L version is intended for attachment to the PRO side carrier. Alternatively, all three SysBags can also be looped on the rear or on a third-party carrier.

From a purely visual point of view, the entire SysBag WP family is seamlessly integrated into the design concept of the waterproof PRO WP tank bags. Together, the new special stages form a powerful adventure gear that is armed for all imponderables. We wish you an exciting time out there, with lots of new experiences in previously unknown territory. And your luggage always stays nice and dry, that's for sure.



Quick disassembly from the  
carrier and wearing comfort for  
extended breaks



# SYSBAG WP L

The largest model of the SysBag WP trio is made entirely of TPU material and has a total volume of 40 liters.

The SysBag WP L is designed for off-road use without exception: the belt buckles of the front compartment are deliberately attached to the top so that no branches can get caught on narrow paths. The outer edges of the bag are covered with robust Hypalon material, which provides additional protection in the event of a fall. With the four compression straps on both sides, the bag can be lashed to form a compact unit, even with a small load.

## INCLUDED IN DELIVERY

SysBag WP L saddle bag (associated adaptor plates sold separately)

 27 - 40 l  48.0 x 22.0 x 41.0 cm  2,900 g

SysBag WP L	BC.SYS.00.006.10000	220 €
Left adaptor plate for SysBag WP L	SYS.00.006.10000L/B	50 €
Right adaptor plate for SysBag WP L	SYS.00.006.10000R/B	50 €

Will it fit your motorcycle? Use the bike filter on [sw-motech.com](https://www.sw-motech.com)

## MATERIAL

- Made from TPU material
- Roll-top made of 210 Ripstop TPU

## FUNCTION

- Attachment to the PRO side carrier or by looping on the rear or external carriers
- 100% waterproof in the main compartment
- Roll-top closure
- spacious additional compartment on the front for rain gear or maps in DIN A4 format
- One waterproof, zippered compartment on the inside of the lid and one additional compartment
- Four plastic feet for improved stability and protection for the underside
- MOLLE patch for attaching accessory bags
- Reinforced handles
- Reflective details for better visibility
- Lashing eyelets for attaching cable locks
- Velcro fasteners to fix the excess belt length



## REQUIRED FOR MOUNTING:

Pro side carrier

> [more on page 150](#)



Easy attachment to the removable PRO side support



Waterproof main compartment with roll top closure

# SYSBAG WP M



The SysBag M WP is a robust soft luggage solution with an adventure look. It is mounted either on the SLC carrier or by looping it on the tail.

Similar to the waterproof tank bags, the SysBag M WP is made from a TPU base and EVA components. Both materials are thermally welded and joined together to form a compact unit, making the bag completely waterproof.

## INCLUDED IN DELIVERY

SysBag WP L saddle bag (associated adapter plates sold separately)



 17 - 23 l  32.5 x 16.5 x 41.0 cm  1,900 g

SysBag WP M	BC.SYS.00.005.10000	170 €
Left adaptor plate for SysBag WP M	SYS.00.005.10000L/B	40 €
Right adaptor plate for SysBag WP M	SYS.00.005.10000R/B	40 €

Will it fit your motorcycle? Use the bike filter on [sw-motech.com](http://sw-motech.com)

## TIP:

Bike-specific SLC-carriers are available for over 230 models. With their compact form they will fit perfectly with the contours of your motorcycle.

> [more on page 152](#)



## MATERIAL

- Made of TPU material and EVA plastic
- 210 ripstop TPU roll top

## FUNCTION

- Attachment to the SLC carrier or by looping on the tail or external carriers
- 100% waterproof
- Waterproof zipper compartment on the inside of the lid
- MOLLE patch for attaching accessory bags
- Reinforced handles
- Reflective details for better visibility
- Two adjustable positions when mounting on the adapter plate (50 mm difference)
- Lashing eyelets for attaching cable locks
- Velcro fasteners to fix the excess belt lengths



Stable hold on the model-specific SLC side support



100 % waterproof

# SYSBAG WP S

The smallest model of the SysBag WP family impresses with its enormous versatility. It cuts a fine figure on adventure bikes as well as sporty street machines and despite persistent external influences.

Like the slightly larger M version, the SysBag WP S has an EVA component incorporated on the front. The result is a clear, elegant shape, the lamination makes the bag waterproof and UV-resistant.

## INCLUDED IN DELIVERY

SysBag WP S saddle bag (associated adapter plates sold separately)



 12 - 16 l  32.5 x 16.5 x 33.0 cm  1,600 g

SysBag WP S	BC.SYS.00.004.10000	140 €
Left adaptor plate for SysBag WP S	SYS.00.004.10000L/B	30 €
Right adaptor plate for SysBag WP S	SYS.00.004.10000R/B	30 €

Will it fit your motorcycle? Use the bike filter on [sw-motech.com](http://sw-motech.com)

## MATERIAL

- Made of TPU material and EVA plastic
- 210 ripstop TPU roll top

## FUNCTION

- Attachment to the SLC carrier or by looping on the tail or external carriers
- 100% waterproof
- Waterproof zipper compartment on the inside of the lid
- MOLLE patch for attaching accessory bags
- Reinforced handles
- Reflective details for better visibility
- Lashing eyelets for attaching cable locks
- Velcro fasteners to fix the excess belt lengths

## TIP:

Bike-specific SLC-carriers are available for over 230 models. With their compact form they will fit perfectly with the contours of your motorcycle.

> [more on page 152](#)



Easy attachment to the SLC carrier thanks to 3-point attachment



Overlapping lid made of TPU material

# BLAZE GOES PRO

Since 2010, the BLAZE System has completely rejected the notion that sportbikes can't have high-quality, stable, convenient and great-looking luggage systems. Even the most skeptical sport and naked bike riders are convinced they can enjoy the convenience of a luggage system for commuting or touring when they see the removable support arms and the stable but lightweight cases.

We have completely reworked the BLAZE System for the first time in eleven years and focused predominantly on aesthetics and material. The saddlebags now come with a new look, in a rich black and subtle logo details that enhance the style of your motorcycle. The side walls in EVA material lend the bags more stability.

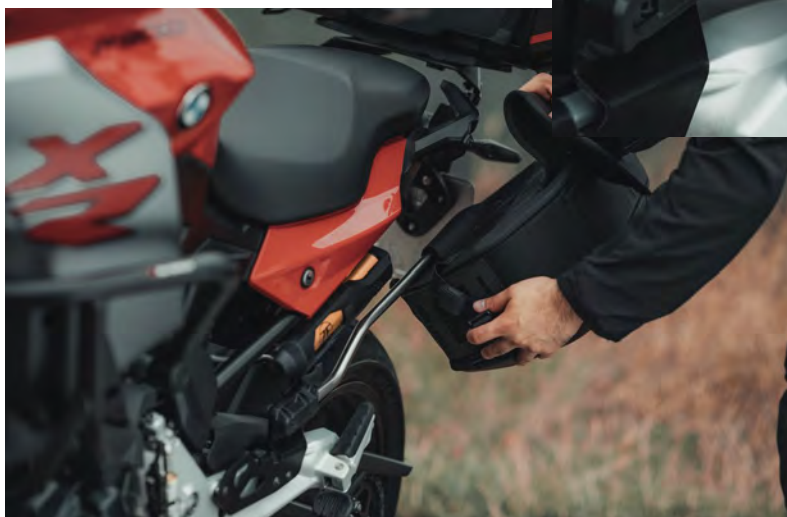

As easy as ever:  
The support arms can be easily  
clicked into place and just as  
easily removed.

Less is more: the bike-specific  
support arms are integrated into  
the motorcycle's overall look.



[Discover more on our  
youtube channel!](#)



Safety strap with Velcro® ensures a secure hold



EVA and MOLLE – which sounds like the title of a children's adventure book, are two terms which have now secured a place in the SW-MOTECH world. Usually, these features come with the PRO package. - our premium quality seal for soft luggage.

We now offer a PRO version for our tried and true BLAZE System. This represents the best of all worlds, born of experience over the past 10 years. After using these motorcycle bags on a daily basis, you will learn the real value and capabilities of EVA and MOLLE. However, the most important news is: underlying BLAZE attachment system remains unchanged as there is simply nothing to improve. PRO BLAZE meets the highest demands of a sports luggage system: lightning-fast changeover for journeys and minimal disruption to handling performance. We are looking forward to another fast-paced decade and wish you the best riding experience without compromise.





# PRO BLAZE SADDLEBAGS

The PRO BLAZE luggage system features impressive aesthetics, light weight and a clever attachment system. A Velcro® strap is fastened over the passenger seat and bears the weight of the bags, while the support arms provide stability. Developed specifically for sport motorcycles, the stable and aerodynamic saddlebags have minimal effect on handling performance. When traveling without luggage, the bike-specific support arms can be easily removed with only discreet mounting brackets remaining.

## INCLUDED IN DELIVERY

2 PRO BLAZE saddlebags, 2 waterproof inner bags, bike-specific mounting kit with 2 support arms, paint protection film

 15 – 20 l  46.0 x 32.0 x 18.0 – 24.0 cm  1,500 g

PRO BLAZE Saddlebags

starting at 360 €

Will it fit your motorcycle? Use the bike filter on [sw-motech.com](https://www.sw-motech.com)



## TIP:

For motorcycles with higher exhaust pipes, we offer the specially developed BLAZE H variation. Due to the elevated position, the bags are not affected by the heat radiation of the exhaust.

## MATERIAL

- Made from durable, highly UV-resistant 1680D ballistic nylon with water resistant interior coating
- Side walls in dimensionally stable, laminated EVA material

## FUNCTION

- Removable support arms
- Volume expansion with zipper from 15 to 20 liters
- A high-performance Velcro® strap secures the left and right saddlebag and bears the weight of the luggage
- Main compartment to be loaded from above
- Outer pocket with covered zipper
- MOLLE attachment in strong hypalon material on the front for fastening accessory pouches
- Reflective details for increased visibility
- Practical carrying handle



Sporty look and secure hold



# SIDE BAG SYSTEM LH ASYMMETRICAL

The stylish LH side bags combine the weight advantages of a soft bag with the stability advantages of a hard case. The classic diamond-tuck Legend gear look combines with high-tech materials and a modern, locking fastening system. This allows the bags to be mounted onto the fender strut with the turn of a hand via an integrated lock mechanism on the SLH side carrier. When riding without luggage, the motorcycle only shows unobtrusive fixing points.

## INCLUDED IN DELIVERY

System: Legend Gear side bag(s) LH, support element(s), key, mounting material



Side bag system LH asymmetrical	starting at 720 €
Will it fit your motorcycle? Use the bike filter on <a href="https://www.sw-motech.com">sw-motech.com</a>	

19.5 l	42.0 x 24.0 x 28.0 cm	2,200 g
Legend Gear side bag LH1	BC.HTA.00.682.11000	280 €
Will it fit your motorcycle? Use the bike filter on <a href="https://www.sw-motech.com">sw-motech.com</a>		

25.5 l	47.0 x 24.0 x 39.0 cm	2,800 g
Legend Gear side bag LH2	BC.HTA.00.682.10000	300 €
Will it fit your motorcycle? Use the bike filter on <a href="https://www.sw-motech.com">sw-motech.com</a>		

## MATERIAL

- Robust & easy to clean: Made from weather- and UV-resistant 600D polyester and grained artificial leather
- Excellent form stability thanks to ABS plastic rear panel and top as well as PE-reinforced sides

## FUNCTION

- Abundant storage: 25.5 liters (left) / 19.5 liters (right)
- LH2 features the MOLLE system for fastening accessory bags
- Integrated anti-theft protection on the inside of the bag is activated with a quarter turn, additional anti-theft protection from lockable bag lid
- Pocket handle allows convenient carrying
- For Harley-Davidson models: combining with original Harley-Davidson accessories (Sissy bars, racks) is possible

## REQUIRED FOR MOUNTING:

The bike-specific SLH side carrier is mounted on the original attachment points of the fender strut. The Legend Gear side bag LH is easily installed and removed thanks to a quick-lock system



Secure hold on the stable SLH side carrier



Classic diamond-tuck Legend Gear look



# SIDE BAG SYSTEM LH SYMMETRIC

We know sometimes form is just as important as function, so we've made the LH system available in a symmetrically-sized set. Sacrificing some luggage capacity, this set – literally – balances out the look of your luggage and can allow for additional custom exhaust configurations. It consists of an LH1 on the right side and an LH1 side bag on the left side.



## INCLUDED IN DELIVERY

System: Legend Gear side bag(s) LH, support element(s), key, mounting material

 19.5 l  42.0 x 24.0 x 28.0 cm  2,200 g

Side bag system LH symmetric		starting at 700 €
Legend Gear side bag LH1 left	BC.HTA.00.682.10000	280 €
Legend Gear side bag LH1 right	BC.HTA.00.682.11000	280 €

Will it fit your motorcycle? Use the bike filter on [sw-motech.com](https://www.sw-motech.com)

## PLEASE NOTE:

The SLH carrier for the left side is offered in two different versions - for the LH1 or for the LH2 side case. Please use the bike-filter on the website to choose your specific model.

## MATERIAL

- Robust & easy to clean: Made from weather- and UV-resistant 600D polyester and grained artificial leather
- Excellent form stability thanks to ABS plastic rear panel and top as well as PE-reinforced sides

## FUNCTION

- Abundant storage: 19.5 liters on each side
- Symmetric look
- Integrated anti-theft protection on the inside of the bag is activated with a quarter turn, additional anti-theft protection from lockable bag lid
- Pocket handle allows convenient carrying
- For Harley-Davidson models: Combining with original Harley-Davidson accessories (Sissy bars, racks) is possible



A visual eye-catcher thanks to symmetrical case size



Lockable lid

# SLH SIDE CARRIER

The bike-specific bag carrier can be easily and quickly mounted on to original attachment points. The quick lock system allows LH Legend Gear side bags to be attached and removed in just a few easy hand movements, without the driver foregoing reliable bag fastening.

## LIEFERUMFANG

1 x SLH Side carrier, mounting instructions, mounting material

## MATERIAL

- Made of steel, black powder coated

## FUNCTION

- Secure and quick mount at original growing points
- Developed for Harley-Davidson models and selected cruisers
- Use with Harley-Davidson original accessories (sissy bar, rack) possible



SLH side carrier left	starting at € 70
SLH side carrier right	starting at € 70
Will it fit your motorcycle? Use the bike filter on <a href="https://www.sw-motech.com">sw-motech.com</a>	



[Discover more on our youtube channel!](#)





# SIDE BAG LC1/LC2

The LC1/LC2 side bags combine classic looks with contemporary functionality. The bags can be easily mounted and removed from the SLC side carriers thanks to a quick-lock system. Durable Napalon synthetic leather and waxed canvas fabric highlight the vintage design of the Legend Gear soft luggage. The LC1/LC2 side bags are available in a classic-looking two tone Black-Brown or the all-black, Black Edition.

## INCLUDED IN DELIVERY

Legend Gear LC1/LC2 side bags, waterproof inner bag



 9,8 l  31.0 x 26.0 x 14.0 cm  1,200 g

Side bag LC1, left	BC.HTA.00.401.10100L	150 €
Side bag LC1, left - Black Edition	BC.HTA.00.401.10200L	150 €
Side bag LC1, right	BC.HTA.00.401.10100R	150 €
Side bag LC1, right - Black Edition	BC.HTA.00.401.10200R	150 €

Will it fit your motorcycle? Use the bike filter on [sw-motech.com](http://sw-motech.com)

 13,5 l  31.0 x 35.0 x 14.0 cm  1,400 g

Side bag LC2, left	BC.HTA.00.402.10100L	165 €
Side bag LC2, left - Black Edition	BC.HTA.00.402.10200L	165 €
Side bag LC2, right	BC.HTA.00.402.10100R	165 €
Side bag LC2, right - Black Edition	BC.HTA.00.402.10200R	165 €

Will it fit your motorcycle? Use the bike filter on [sw-motech.com](http://sw-motech.com)

## TIP:

Bike specific SLC carriers are available for over 250 models. With their compact form they will fit perfectly with the contours of your motorcycle.

> [more on page 152](#)



Quick-lock system at the back

## MATERIAL & FUNCTION

- Napalon synthetic leather and waxed canvas, water-resistant inner lining
- One- or two-sided mount
- Mix and match. Bags are available as left or right, small or large, brown or black variants
- Quick lock system made of glass fiber reinforced polyamide
- Roll closure and waterproof inner bag provide rain protection



Side bag LC2 left in black/brown

# LC SIDE BAG SYSTEM

For the very best performance and convenience: The complete package. Before releasing any new luggage application, we determine which configuration(s) best suit a specific motorcycle model. Our bike-specific luggage systems account for variations such as exhaust systems and tail section design to present you the best possible combination of Legend Gear LC1 and LC2 side bags for your particular motorcycle. Some may even have one bag, usually to accommodate high exhausts.

## INCLUDED IN DELIVERY

Legend Gear side bag(s) LC, waterproof inner bag(s)  
SLC side carriers, mounting material



LC side bag system

starting at 240 €

Will it fit your motorcycle? Use the bike filter on [sw-motech.com](https://www.sw-motech.com)

## TIP:

Find the right system with the bike filter on the SW-MOTECH online store: simply enter your motorcycle, model and model year and you'll see what fits your bike.

## FUNCTION

- The right set for each bike – for one or both sides and with bags in different sizes, even suitable for bikes with high exhaust
- Bike-specific development of the SLC side carrier for best fit
- Available for one or both sides depending on tail shape
- Simple mounting - all required parts are included in the set

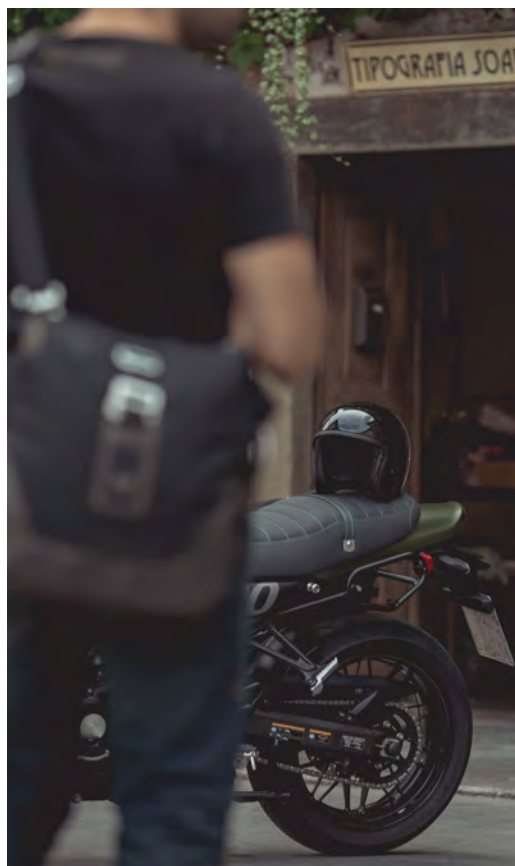



Classic retro look for your bike

## SADDLEBAG LS1/LS2

These elegant bags can be easily attached to the SLS saddle strap and impress with their exceptional design. Available in two different sizes, the saddlebags can be mounted on one or both sides and can be combined with accessory bags.



### INCLUDED IN DELIVERY

Legend Gear saddlebag LS1/LS2, waterproof inner bags,  
2 fastening hooks, 2 with eyelets for mounting on license plate holder,  
2 fastening straps

 9,8 l  31.0 x 26.0 x 14.0 cm  1,050 g

Saddlebag LS1 BC.HTA.00.401.10000 130 €

Will it fit your motorcycle? Use the bike filter on [sw-motech.com](http://sw-motech.com)

 13.5 l  31.0 x 35.0 x 14.0 cm  1,300 g

Saddlebag LS2 BC.HTA.00.402.10000 145 €

Will it fit your motorcycle? Use the bike filter on [sw-motech.com](http://sw-motech.com)



### SHOULDER STRAP:

With the LA4 shoulder strap you can easily transport your luggage when you're on the go. The quick, easy-to-use fastening hooks attach to any of the Legend Gear tank bags, sidebags or tail bags.

> [more on page 119](#)

### MATERIAL & FUNCTION

- Napalon synthetic leather and waxed canvas, water-resistant inner lining
- Holding straps and safety straps with aluminum hooks enable secure and flexible fastening to the SLS saddlebag holder
- Converts to a very practical messenger-style shoulder bag in combination with the LA4 shoulder strap
- Waterproof inner bag included in delivery

## SLS SADDLE STRAP

The SLS saddle strap provides secure grip for the LS1/LS2 saddlebags on straight bench saddles with a passenger seat. The elegant saddlebags from the Legend Gear series lend a special touch to Cafe Racers, Retro and Street Bikes.

 39.0 x 21.0 cm

SLS Saddle strap BC.HTA.00.403.10000 50 €

Will it fit your motorcycle? Use the bike filter on [sw-motech.com](http://sw-motech.com)

### MATERIAL & FUNCTION

- Napalon synthetic leather
- Simple mounting by looping the SLS saddle strap support straps under the seat

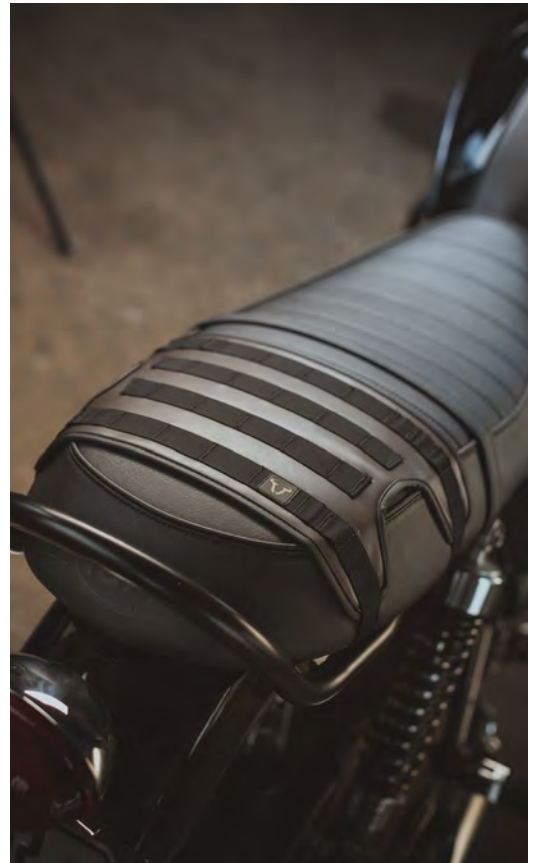



# TAIL BAGS

<b>PRO TAIL BAGS</b>	<b>96</b>
<b>PRO TAIL BAGS ACCESSORIES</b>	<b>112</b>
<b>LEGEND GEAR TAIL BAGS</b>	<b>116</b>
<b>ACCESSORIES LEGEND GEAR TAIL BAGS</b>	<b>118</b>
<b>ION TAIL BAGS</b>	<b>120</b>
<b>DRYBAGS</b>	<b>124</b>
<b>ACCESSORIES DRYBAGS</b>	<b>131</b>

# TIME FOR SOMETHING NEW

For many years, tail bags have been one of the most popular products in our range: they're extremely versatile and we manufacture them in just about every conceivable shape and size.

## THE NEW PRO SERIES

The new tail bags from the PRO series are - like the successful PRO tank bags - made of indestructible 1680 D ballistic nylon and match the look of the tank bags.

They also impress with their high-quality workmanship and sophisticated features: reflective attachments ensure better visibility, robust and patented lashing hooks allow you to secure the bags quickly and easily on to the motorcycle and a MOLLE system on the top lets you attach accessory bags.

[More information about the MOLLE system can be found on page 95](#)

Side bags and volume extensions offer even more flexibility.



[Discover more on our youtube channel!](#)



The new patented lashing hooks make things easy for you. You can remove the straps from the bag holders quickly and easily, even when wearing gloves.





The small and compact PRO Roadpack is perfect for sporty bikes. It fits everything you need for a day trip.

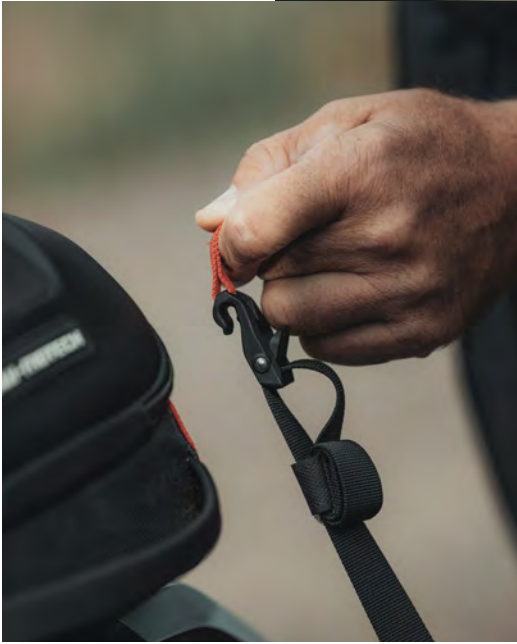

#### **NEW PATENT**

The new patented lashing hooks allow you flexibility when attaching PRO tail bags. The straps are hooked and tensioned in one step. To remove the bag, the strap is released in one easy step and removed from the lashing eyelet by pulling on the drawstring.

The excess strap length can be secured to the strap with a Velcro® fastener. This allows the bag to be used on different motorcycles, and the strap length can be adjusted accordingly. No more flapping straps, and you still have options if you want to use the bag on another motorcycle.

#### **TRULY VERSATILE**

Add on bags such as the PRO Pocket, PRO Plus or PRO Tentbag and you have a wide range of options to help organize your gear and expand luggage capacity. Helpers such as the T-Lock make the accessory bags even more convenient to use.

**[You can find out more about the T-Lock on page 238.](#)**



# PRO TAIL BAG OVERVIEW



PRO Roadpack  
Total volume: 8 – 14 l  
> [more on page 100](#)



PRO Rearbag  
Total volume: 22 – 34 l  
> [more on page 103](#)



PRO Rackpack  
Total volume: 32 – 42 l  
> [more on page 104](#)



PRO Cargobag  
Total volume: 50 l  
> [more on page 107](#)



PRO Travelbag  
Total volume: 65 l  
> [more on page 108](#)



Shop now!  
[sw-motech.com](http://sw-motech.com)



PRO Seat Ring

[> more on page 111](#)



PRO Base

[> more on page 112](#)



PRO Plus

Total volume: 3 – 6 l

[> more on page 112](#)



PRO Tentbag

Total volume: 18 l

[> more on page 113](#)

# PRO ROADPACK

The PRO Roadpack is a compact bag that fits perfectly on the tail of small and sporty motorcycles. The volume can be expanded from 8 to 14 liters via the zipper. An inner bag with zipper in the lid offers storage for valuables.

In addition to the enclosed loop straps, two Velcro straps and a slot on the underside enable quick and secure attachment to the seat or rack. The patented lashing hooks allow for flexibility when attaching a tail bag. The straps are hooked and tensioned in one step.



## INCLUDED IN DELIVERY

PRO Roadpack tail bag, waterproof inner bag, 4 loop straps with lashing hooks, paint protection film

8 – 14 l 36.0 x 28.0 x 15.0 – 23.0 cm 900 g

PRO Roadpack tail bag BC.HTA.00.307.30000 130 €

Will it fit your motorcycle? Use the bike filter on [sw-motech.com](https://www.sw-motech.com)

## MATERIAL

- Top of the bag made of laminated and dimensionally stable EVA material
- Made of durable and highly UV-resistant 1680D Ballistic Nylon with splashproof inner lining
- Underside made of anti-slip material
- MOLLE attachment made of stable Hypalon material on the upper side for attaching accessory bags.

## FUNCTION

- Volume expansion in the bottom from 8 to 14 liters
- Universal fit for almost all motorcycles
- Zipper mesh compartment in the lid
- Robust lashing eyelets for secure fastening of the bag at 4 points and for lashing accessory bags
- Reflective details for better visibility
- Zipper management: Elastic loops prevent the zipper pulls from fluttering
- MOLLE attachment made of stable Hypalon material on the upper side for attaching accessory bags.
- Simple and quick attachment of the bag to the motorcycle with loop straps with a patented lashing hook.
- Weather protection thanks to the supplied waterproof inner bag
- Sturdy carrying handle



Designed for the tail of sporty motorcycles

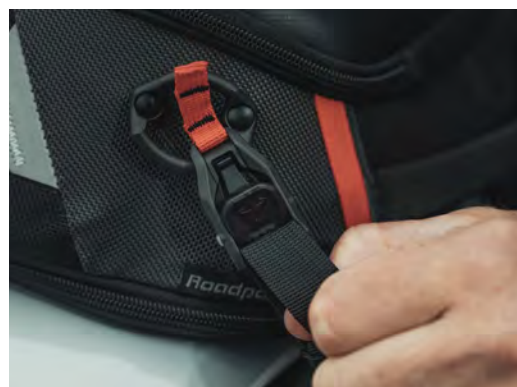

Patented lashing hooks for quick attachment

# PRO REARBAG

With its universal fit, the PRO Rearbag is just as suitable for use on street bikes as it is for the passenger seat of an adventure touring machine. With a volume of 22 liters, which can be expanded up to 34 liters, the bag offers ample space for luggage on the passenger seat of your motorcycle.

You can even stow your helmet in the Rearbag. The slightly convex underside adapts to the seat and is equipped with anti-slip material. The patented lashing hooks allow for flexibility when attaching the bag. The straps are hooked and tensioned in one step.

## INCLUDED IN DELIVERY

PRO Rearbag tail bag, waterproof inner bag, 4 loop straps with lashing hooks, 2 x lashing eyelets for attachment to the plate holder

 22 – 34 l  40.0 x 43.0 x 25.0 – 37.0 cm  1,800 g

PRO Rearbag tail bag BC.HTA.00.304.30000 210 €

Will it fit your motorcycle? Use the bike filter on [sw-motech.com](http://sw-motech.com)

## MATERIAL

- Top of the bag made of laminated and dimensionally stable EVA material
- Made of durable and highly UV-resistant 1680D Ballistic Nylon with splashproof inner lining
- Underside made of anti-slip material
- MOLLE attachment made of stable Hypalon material on the upper side for attaching accessory bags.

## FUNCTION

- Volume expansion in the top area from 22 to 34 liters
- Universal fit for almost all motorcycles
- Zipper mesh compartment in the lid
- Additional storage thanks to two outer pockets with covered zippers.
- Storage space for a helmet
- Robust lashing eyelets for secure fastening of the bag at 4 points and for lashing accessory bags
- Simple and quick attachment of the bag to the motorcycle with loop straps with a patented lashing hook.
- Reflective details for better visibility
- Zipper management: Elastic loops prevent the zipper pulls from fluttering
- Weather protection thanks to the supplied waterproof inner bag
- Sturdy carrying handle



### TIP:

The PRO Rearbag features a MOLLE Patch on the lid. If you need more storage, you can simply attach an accessory bag, such as the PRO Plus.

> [more on page 112](#)



Mesh compartment under the lid for valuables

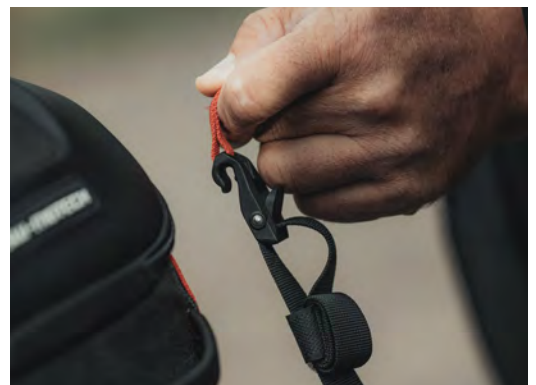

Secure velcro strap fastening



# PRO RACKPACK

The robust PRO Rackpack was developed specifically for use on racks and is a practical travel bag in combination with the shoulder strap. Combined with the luggage rack extension, it can be easily mounted on the STREET RACK or the ADVENTURE RACK as well as on standard carriers, passenger seat or a sissy bar.

The extensions on both sides of the tail bag allow an expansion of the volume from 32 to 42 liters. The patented lashing hooks allow for flexibility when attaching the bag. The straps are hooked and tensioned in one step.

## INCLUDED IN DELIVERY

PRO Rackpack tail bag, waterproof inner bag, 4 loop straps with lashing hooks, shoulder strap, paint protection film

 32 – 42 l  33.0 x 56.0 – 68.0 x 26.0 cm  2,400 g

PRO Rackpack tail bag

BC.HTA.00.305.30000

210 €

Will it fit your motorcycle? Use the bike filter on [sw-motech.com](http://sw-motech.com)



## TIP:

The PRO Rackpack can be securely attached to the rack extension. The large contact surface provides a secure hold.

> [more starting from page 169](#)



## MATERIAL

- Made of durable and highly UV-resistant 1680D Ballistic Nylon with splashproof inner lining
- Underside made of anti-slip material
- MOLLE attachment made of stable Hypalon material on the upper side for attaching accessory bags.

## FUNCTION

- Universal fit for almost all motorcycles
- Large mesh compartment with zipper on the inside of the lid
- Additional storage thanks to two outer pockets with covered zippers.
- Inner mesh compartments with zippers on both outer pockets
- Volume expansions on both outer sides
- Robust lashing eyelets for secure fastening of the bag at 4 points and for lashing accessory bags
- Simple and quick attachment of the bag to the motorcycle with loop straps with a patented lashing hook.
- Reflective details for better visibility
- Zipper management: Elastic loops prevent the zipper pulls from fluttering
- Weather protection thanks to the supplied waterproof inner bag
- Sturdy carrying handle



Storage space for a helmet



A more secure hold on the rack



# PRO CARGOBAG

With a volume of 50 liters, the Cargobag is one of the most versatile bags in the PRO tail bag series. The soft bag adapts very well to many different tail designs and offers numerous transport storage solutions on the motorcycle.

Large outer pockets on both sides, which can be compressed with Velcro straps if necessary, make the Cargobag even more adaptable. A large mesh pocket in the lid provides space for small items and bungee tie-downs with straps on the outside support other luggage items.

## INCLUDED IN DELIVERY

PRO Cargobag, waterproof inner bag, 4 loop straps, 2 lashing eyelets for attaching to a plate holder, paint protection film

 50 l  50.0 x 70.0 x 26.0 – 33.0 cm  1,700 g

PRO Cargobag tail bag BC.HTA.00.306.30000 190 €

Will it fit your motorcycle? Use the bike filter on [sw-motech.com](http://sw-motech.com)

## MATERIAL

- Made from durable, highly UV-resistant 1680D ballistic nylon with water resistant interior coating
- Underside made of anti-slip material
- MOLLE system made of sturdy Hypalon material on the top for attaching accessory bags

## FUNCTION

- Universal fit for almost all motorcycles
- 2 outer pockets with zippers
- 2 exterior bungee tie-downs for additional luggage
- Storage space for a helmet
- Zipper mesh compartment in the lid
- Covered zippers
- Zipper management: rubber straps prevent zipper from flapping
- Reliable 4-point lashing strap attachment
- Reflective details for better visibility
- Weather protection thanks to the supplied waterproof inner bag
- Robust carrying handle



### TIP:

Accessory bags such as the PRO Tentbag can be attached to the PRO Cargobag.

> [more on page 113](#)



Attaching with sturdy loop straps



Large outer pockets



# PRO TRAVELBAG

With a volume of 65 liters, the PRO Travelbag is the largest tail bag in the entire Premium series. Thanks to the conically shaped underside, the tail bag can be quickly and easily positioned and clamped on the pillion seat. The PRO Travelbag has a large main compartment and two spacious side pockets with waterproof zippers. An overlapping lid on the top provides protection from moisture. With the shoulder strap, the PRO Travelbag can be converted into a travel bag in no time at all.

## INCLUDED IN DELIVERY

PRO Travelbag tail bag, waterproof inner pocket, 4 loop straps with lashing hooks, 2 lashing eyes for attachment to the license plate holder, shoulder strap, protective paint film



 65 l  75.0 x 33.5 x 31.0 cm  3,300 g

PRO Travelbag tail bag

BC.HTA.00.301.30000

320 €

Will it fit your motorcycle? Use the bike filter on [sw-motech.com](https://www.sw-motech.com)

## TIPP:

The PRO Travelbag has MOLLE patches on the lid and on the front. If you need even more storage space, you can attach additional bags such as the PRO Plus there.

More on page 112

## MATERIAL

- Made of tough and particularly UV-resistant 1680D Ballistic
- Underside made of anti-slip material
- MOLLE system made of stable Hypalon material

## FUNCTION

- t Three mesh compartments with zipper on the inside of the lid
- Additional storage thanks to two outer pockets with covered zippers
- MOLLE system on the top and front for additional pockets
- Robust lashing eyes for secure fastening of the bag at 4 points and for lashing accessory bags
- Simple and quick attachment of the bag to the motorcycle via loop straps with patented lashing hooks
- Reflective details for better visibility
- Zipper management: rubber loops prevent flapping
- Weather protection thanks to the supplied waterproof inner bag
- Stable carrying handles



The sturdy locks can also be easily operated with motorcycle gloves.

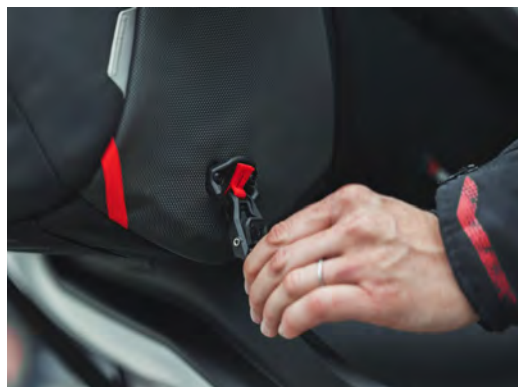

Thanks to the patented lashing hooks, the bag can be tightened quickly and easily.



# PRO SEAT RING

The PRO Seat Ring allows you to attach a PRO tank ring to your seat. That means you can enjoy the benefits of the PRO tank ring with its magnetic guide and extremely easy fastening system. This is especially handy when it's not possible to attach a tank ring to the front of the tank.

The PRO tank ring sits on a fiberglass-reinforced plastic plate, which is connected to a rubber pad for a more secure hold. Lashing straps secure the plate to the seat. There are four flat-bottomed PRO tank bags that are compatible with the PRO Seat Ring: PRO Micro, Daypack, Sport and Yukon WP can all be held securely.



## INCLUDED IN DELIVERY

PRO seat ring, rubber pad, plastic plate, lashing straps

PRO Seat Ring	TRT.00.787.21500/B	45 €
Will it fit your motorcycle? Use the bike filter on <a href="http://sw-motech.com">sw-motech.com</a>		

## PRO TIP:

Fits with the four PRO tank bags: Micro, Daypack, Sport and Yukon WP

> [more on pages 48](#)



## MATERIAL & FUNCTION

- Fiberglass-reinforced plastic plate
- To be used on the passenger seat
- For PRO tank bags with a straight bottom

# ACCESSORIES

## PRO TAIL BAGS

### PRO BASE

The PRO Base is the perfect solution for flexibility when transporting small bags on the passenger seat. A MOLLE system panel, made of robust Hypalon material, is sewn onto a ballistic nylon base and can be attached to the seat with the provided lashing straps. The MOLLE system provides a secure hold for accessory bags such as the PRO Plus or PRO Pocket.



#### INCLUDED IN DELIVERY

PRO Base, 2 lashing straps

 16.6 x 24.0 cm

PRO Base	BC.HTA.00.309.30000	20 €
----------	---------------------	------

Will it fit your motorcycle? Use the bike filter on [sw-motech.com](https://www.sw-motech.com)

#### MATERIAL & FUNCTION



- MOLLE system made of sturdy Hypalon material on the top for attaching accessory bags
- Underside made of anti-slip material
- Versatile use on seats in the passenger area
- Easy attachment with lashing straps

### PRO PLUS

The PRO Plus accessory bag features a circumferential zipper and an outer compartment in the lid. You can expand the volume of the bag from three to six liters by expanding the zipper. On the inside of the lid, there is a mesh compartment with zipper for documents and keys. At the bottom of the inner compartment, pens, tools or other small items can be secured using the elastic plastic loops.

#### INCLUDED IN DELIVERY

PRO Plus accessory bag, waterproof inner bag

 3 – 6 l  28.0 x 21.0 x 7.0 – 12.0 cm  400 g

PRO Plus accessory bag	BC.HTA.00.308.30000	55 €
------------------------	---------------------	------

Will it fit your motorcycle? Use the bike filter on [sw-motech.com](https://www.sw-motech.com)

#### MATERIAL & FUNCTION

- Additional compartment with zipper on the outside of the lid
- Zipper mesh compartment in the lid
- Elastic loops in the inner compartment for securing small parts
- Bottom part features expandable volume from 3 to 6 liters
- Fits almost all bags from the PRO series and bags from the LEGEND GEAR series with a MOLLE attachment



# PRO TENTBAG



The PRO Tentbag tail bag has a capacity of 18 liters and can hold most two-person tents. The tentbag can also be used as additional storage for clothes and other luggage. With the included straps you can easily attach the bag to other large PRO tail bags like the PRO Cargobag or the PRO Travelbag.

The PRO Tentbag impresses with its high-quality workmanship and sophisticated features: the patented lashing hooks allow for flexibility when attaching the tail bag. The straps are hooked and tensioned in one step.



## INCLUDED IN DELIVERY

PRO Tentbag, 2 straps with 2 lashing hooks each

18 l  17.0 x 58.0 x 17.0 cm  400 g

PRO Tentbag tail bag

BC.HTA.00.350.30000

50 €

Will it fit your motorcycle? Use the bike filter on [sw-motech.com](https://www.sw-motech.com)

## MATERIAL & FUNCTION

- Made of durable and highly UV-resistant 1680D Ballistic Nylon with splashproof inner lining
- Easy attachment with straps and lashing hooks to other PRO tail bags
- Long zipper with cover
- 4 carrying loops
- Capacity for a typical two person tent
- Reflective details for better visibility



A secure hold on the PRO Cargobag



Patented lashing hook attachment

# MOLLE

With the introduction of the PRO series, MOLLE is now an integral part of SW-MOTECH soft luggage systems. What exactly does MOLLE mean and what are its advantages?

The acronym MOLLE stands for MODular Lightweight Load-carrying Equipment and describes a carrying system originally designed for military use for attaching bags and equipment. We've taken the advantages of this tried and tested system, added additional functions and thus made our motorcycle luggage even more flexible and individually adaptable.

The result is relatively simple: SW-MOTECH bags equipped with MOLLE systems allow you to attach a wide range of accessory bags. Whether it's a small Smartphone Drybag or the new PRO Plus, whatever you attach here is entirely up to you.

MOLLE has been integrated into the design of most of our PRO and Legend line of bags, as well as the DryBag 700.

You get the idea, but what can you do with it? Quickly lash on the PRO Plus bag to the PRO Rackpack and now there's plenty of room for your rain jacket. Do you want your navigation app to guide you to your destination today? With the Tablet Drybag on the PRO Sport tank bag, you





have everything in view. Discover the possibilities and be even more flexible in arranging the luggage on your motorcycle.

Our specially developed quick connectors make using MOLLE even easier. With the T-Lock holder you can attach the Smartphone Drybag in no time at all. Using the MOLLE system doesn't require a quick connector, though. Using standard MOLLE attachments provides a very secure hold. You can find out which attachment best suits your needs in the respective article descriptions and mounting instructions.

By the way: it doesn't matter if you put a bag on the MOLLE panel or not. Because MOLLE is not only practical, it also looks sharp on its own.



# TAIL BAG LR1

The practical combination of tail bag and full-fledged backpack makes this a versatile companion for every tour – no matter whether on the motorcycle or on foot.

## INCLUDED IN DELIVERY

Legend Gear LR1 tail bag, rain cover, 4 loop straps with Legend Gear hooks, 2 straps for attaching to plate holder, adhesive protective film



17.5 l 30.0 x 17.0 x 40.0 cm 1,100 g

Legend Gear tail bag LR1

BC.HTA.00.404.10000

130 €

Will it fit your motorcycle? Use the bike filter on [sw-motech.com](https://www.sw-motech.com)

## MATERIAL & FUNCTION

- Napalon synthetic leather and waxed canvas, water-resistant inner lining
- Universal fit for seat and tail rack
- Also suitable for bikes with high-mounted exhaust
- Secure hold through 4-point strap mounting
- Converts to a full-fledged backpack with padded, adjustable carrying straps in a few simple steps
- Roll-top closure
- Zippered compartment and padded laptop holder
- Waterproof rain cover



# TAIL BAG LR2

This 48 liter tail bag combines the striking styling and functional design of the Legend Gear line with enough storage for extended tours.

The universal fit allows the bag to be attached to a variety of bike models. This bag can also be mounted on bikes with high exhaust systems and is available either in black-brown or in completely black.

## INCLUDED IN DELIVERY

Legend Gear LR2 tail bag, waterproof inner bag, 4 loop straps with Legend Gear hooks, 2 straps for attaching to license plate holder, adhesive protective foil



48 l 68.0 x 45.0 x 30.0 cm 2,100 g

Legend Gear tail bag LR2	BC.HTA.00.405.10000	300 €
Legend Gear tail bag LR2 - Black Edition	BC.HTA.00.405.10100	300 €

Will it fit your motorcycle? Use the bike filter on [sw-motech.com](https://www.sw-motech.com)

## MATERIAL & FUNCTION

- Napalon synthetic leather and waxed canvas, water-resistant inner lining
- Non-slip underside
- Secure hold thanks to 4-point strap mounting, tie-down straps are also included in delivery
- Waterproof inner bag



# ACCESSORIES

## LEGEND GEAR TAIL BAGS

### TOOL BAG LA5

This member of the Legend Gear line can function as much more than a tool bag. Carry your wallet, smartphone, and other items with ease.

Thanks to a variety of loop and strapping options, the tool bag can be attached to the handlebar and frame at various points.



#### MATERIAL & FUNCTION

- Napalon synthetic leather & waxed canvas, water-resistant inner lining, anodized aluminum hooks.
- Can be carried on a belt or used as a shoulder bag
- Included in delivery: shoulder/waist strap and fastening straps in different lengths
- Durable zippers and Velcro® secure bag contents
- Zippered flap pocket
- Padded compartment

 1.6 l  24.0 x 7.0 x 11.0 cm

Legend Gear Tool Bag LA5

BC.TRS.00.407.10000

60 €







## SHOULDER STRAP LA4

The Legend Gear shoulder strap LA4 allows you to easily turn any Legend saddlebag, tank bag, or tail bag into a practical shoulder bag.

### MATERIAL & FUNCTION

- Padded Legend Gear LA4 shoulder strap provides maximum comfort
- The length of the Legend Gear LA4 shoulder strap can be adjusted from 90cm to 150cm using 2 strap adjusters
- Fastening straps allow you to securely and flexibly attach Legend Gear accessory bags.
- Sturdy fastening hooks made from anodized aluminium

BC.TRS.00.406.10000

30 €

## BOTTLE HOLDER LA6

The MOLLE compatible Legend Gear LA6 Bottle Holder creates convenient add-on storage of a standard bottle of fuel or water to any SW-MOTECH bag with a MOLLE panel.

### MATERIAL & FUNCTION

- Ideal for bottle with a diameter of about 7 cm and a height of about 21 cm (see accessories)
- Velcro features stepless adjustment and makes it possible to attach bottles of slightly different dimensions
- Bottle is additionally secured at the top by an elastic band
- Compatible with LR1 & LR2 tail bags, LR3 messenger bag, LT1 & LT2 tank bags, SLS saddle strap and Legend Gear series SLA tank bag and Drybag 700 tail bag



BC.TRS.00.408.10000

12 €

# ION S

Ideal for small and sporty bikes: the volume of the ION S tail bag can be expanded from 7 to 15 liters using the zipper and offering sufficient storage for drinks, a change of clothes, reflective vest and other small items that are needed on a day trip or short trip.

Two straps with hook-and-loop closure, along with a slot on the underside, enable fast and secure attachment to a seat or rack.

Reinforced sides, a padded lid and cinch straps guarantee a stable, secure fit even when you're riding at speed.



## INCLUDED IN DELIVERY

ION S tail bag, waterproof inner bag, 4 loop straps, adhesive protective film

7 – 15 l 29.0 x 10.0 x 33.0 cm 600 g

ION S tail bag

BC.HTA.00.201.10000

110 €

Will it fit your motorcycle? Use the bike filter on [sw-motech.com](https://www.sw-motech.com)

## MATERIAL

- Durable, highly UV-resistant 600D polyester with water resistant interior coating
- Attractive with the combination of textile fabric made from polyester with black soft vinyl
- Non-slip underside for ideal grip

## FUNCTION

- Volume expansion from 7 to 15 liters, height varies between 10 and 18 cm
- Compact tail bag, ideal for small and sport bikes
- Reflective details for more safety in traffic
- Subtle design elements: stitched SW-MOTECH logo and bull in silver grey
- D-rings for reliable 4-point attachment with loop straps
- Two integrated flaps with hook-and-loop closure plus slot for attaching under the seat or rack
- Easily accessible: Outer pocket and mesh compartment inside the lid
- Large main compartment for individual loading
- Waterproof inner bag included in delivery
- Practical carrying handle



Volume expansion along the bottom



Mesh compartment with zipper in the lid of the bag

# ION M

The ION M tail bag can be attached to nearly any motorcycle tail thanks to its optimized design and the curved, non-slip bottom. It's also possible to use it on the STREET-RACK/ADVENTURE-RACK soft luggage extension.

Especially handy: the tail bag features two outer pockets and a mesh compartment inside the lid. The easy-access 26-liter storage compartment can be expanded to 36 liters by two expanders on the sides, if needed.

## INCLUDED IN DELIVERY

ION M tail bag, waterproof inner bag, 4 long loop straps (67 cm), 4 short loop straps (17 cm), 2 straps for attaching to the plate holder, shoulder strap, paint protection film



 26 – 36 l  44.0 x 30.0 x 30.0 cm  1,500 g

ION M tail bag

BC.HTA.00.202.10000

135 €

Will it fit your motorcycle? Use the bike filter on [sw-motech.com](https://www.sw-motech.com)

## MATERIAL

- Durable, highly UV-resistant 600D polyester with water resistant interior coating
- Attractive with the combination of textile fabric made from polyester with black soft vinyl
- Non-slip underside for ideal grip

## FUNCTION

- Volume expansion from 26 to 36 l via two side zippers, width varies from 44 to 54 cm
- Optimized for the passenger seat or tail of many models
- Reflective details for more safety in traffic
- Subtle design elements: stitched SW-MOTECH logo and bull in silver grey
- 4 D-rings for attaching the shoulder strap or additional pieces of luggage
- No flapping, thanks to reinforced sides
- Easy access: 2 outer pockets and mesh compartment inside lid
- Large main compartment for individual loading
- Waterproof inner bag included in delivery
- Practical carrying handle



# ION L

With 50 liters of volume, the ION L tail bag offers abundant storage space for longer tours. Tie-down straps compress smaller loads, eliminating flapping and also allow for attachment of additional pieces of luggage.

Durable cam buckles and loop straps enable quick strapping and, along with the flexible shape and anti-slip bottom, give the bag a secure hold on the passenger seat or tail. The carrying handle is another added benefit of the spacious ION L tail bag.

Included in delivery

ION L tail bag, waterproof inner bag, 4 loop straps, 2 tie-down straps, 2 straps for attaching to the plate holder, paint protection film



50 l 70.0 x 30.0 x 30.0 cm 1,300 g

ION L tail bag BC.HTA.00.203.10000 140 €

Will it fit your motorcycle? Use the bike filter on [sw-motech.com](http://sw-motech.com)

## MATERIAL

- Durable, highly UV-resistant 600D polyester with water resistant interior coating
- Attractive with the combination of textile fabric made from polyester with black soft vinyl
- Non-slip underside for ideal grip

## FUNCTION

- Volume expansion from 26 to 36 liters via two side zippers, width varies from 44 to 54 cm
- Optimized for the passenger seat or tail of many models
- 4 D-rings for attaching the shoulder strap or additional pieces of luggage
- No flapping, thanks to reinforced sides
- Easy access: 2 outer pockets and mesh compartment inside lid
- Large main compartment for individual loading
- Reflective details for more safety in traffic
- Discreet design features: stitched SW-MOTECH logo and bull in silver-gray
- Waterproof inner bag included in delivery
- Practical carrying handle



# DRYBAGS OVERVIEW



Drybag 700  
Total volume: 70 l  
> [more on page 126](#)



Drybag 600  
Total volume: 60 l  
> [more on page 127](#)



Drybag 350  
Total volume: 35 l  
> [more on page 128](#)



Drybag 180/260  
Total volume: 18/26 l  
> [more on page 129](#)



Drybag 80  
Total volume: 8 l  
> [more on page 130](#)



Drypack storage bags  
Total volume: 4/8/13/20 l  
> [more on page 131](#)





# DRYBAG 700

The ultimate weather-proof solution for travellers who need a lot of storage: The Drybag 700 protects up to 70 liters of gear from moisture and dirt. The tail bag's wide end-to-end upper opening enables quick loading and unloading. Additional Drybags can be attached securely via buckles, and the bottom width can be expanded with a zipper. MOLLE panels front and back create additional possibilities for accessories such as the LA6 Bottle Holder.



## INCLUDED IN DELIVERY

Drybag 700 tail bag, 4 loop straps, shoulder strap

 70 l  76.0 x 75.0 x 30.0 cm  1,850 g

Drybag 700 tail bag BC.WPB.00.021.10000 130 €

Will it fit your motorcycle? Use the bike filter on [sw-motech.com](https://www.sw-motech.com)

## MATERIAL & FUNCTION

- Made of durable 500D polyester with double-sided coating
- Universal fit for almost all motorcycles
- Width of the underside adjustable via a zipper
- Easy to combine with other Drybags
- Padded handle
- D-rings enable bags to be pulled down tight on the motorcycle
- Includes 4 loop straps and 1 shoulder strap
- Reflective details



# DRYBAG 600

The very practical-sized Drybag 600 makes a great tail bag or everyday use duffel bag. Protecting 60 liters of gear from dust and wet weather, the Drybag 600 is easy to clean and can be combined with other Drybag tail bags.

## INCLUDED IN DELIVERY

Drybag 600 tail bag, 4 loop straps, shoulder strap



60 l 71.0 x 33.0 x 33.0 cm 1,300 g

Drybag 600 tail bag	BC.WPB.00.002.10001	80 €
Drybag 600 tail bag – signal yellow	BC.WPB.00.002.10001/Y	80 €

Will it fit your motorcycle? Use the bike filter on [sw-motech.com](http://sw-motech.com)

## MATERIAL & FUNCTION

- Made of durable 500D polyester with double-sided coating
- Universal fit for almost all motorcycles
- Width of the underside adjustable via a zipper
- Easy to combine with other Drybags
- Padded handle
- D-rings enable bags to be pulled down tight on the motorcycle
- Includes 4 loop straps and 1 shoulder strap
- Reflective details



Rugged 500D polyester with coating on both sides



Ample storage for long tours

# DRYBAG 350

The conveniently-sized Drybag 350 makes a great tail bag or everyday use duffel bag. Protecting 35 liters of gear from dust and wet weather, the Drybag 350 is easy to clean and can be combined with other Drybag tail bags.

## INCLUDED IN DELIVERY

Drybag 350 tail bag, 4 loop straps, shoulder strap



35 l 58.0 x 28.0 x 28.0 cm 1,150 g

Drybag 350 tail bag	BC.WPB.00.001.10001	70 €
Drybag 350 tail bag – signal yellow	BC.WPB.00.001.10001/Y	70 €

Will it fit your motorcycle? Use the bike filter on [sw-motech.com](http://sw-motech.com)

## MATERIAL & FUNCTION

- Made of durable 500D polyester with double-sided coating
- Universal fit for almost all motorcycles
- Top roll closure
- 4-point strap attachment
- Comfortable carrying handles
- Easy to combine with other Drybags
- Includes 4 loop straps and 1 shoulder strap
- Also available in Signal Yellow
- Reflective details







# DRYBAG 180/260

Weather proof tail and carrying duffel bag in one: These lightweight Drybags are available in two sizes and can be easily attached to the rear rack, passenger seat or other Drybags.

## INCLUDED IN DELIVERY

Drybag 180/260 tail bag, 4 loop straps, shoulder strap



 18 l  39.0 x 25.0 x 18.0 cm  900 g

Drybag 180 tail bag BC.WPB.00.018.10000 50 €

Will it fit your motorcycle? Use the bike filter on [sw-motech.com](http://sw-motech.com)

 26 l  50.0 x 26.0 x 26.0 cm  1,200 g

Drybag 260 tail bag BC.WPB.00.020.10000 55 €

Will it fit your motorcycle? Use the bike filter on [sw-motech.com](http://sw-motech.com)

## MATERIAL & FUNCTION

- Made of durable 500D polyester with double-sided coating
- Waterproof bag roll-top closure
- Secure four-point attachment, integrated front compartment
- Easy to combine with other Drybags
- Includes 4 loop straps and 1 shoulder strap
- Bottom plastic plate for more stable shape

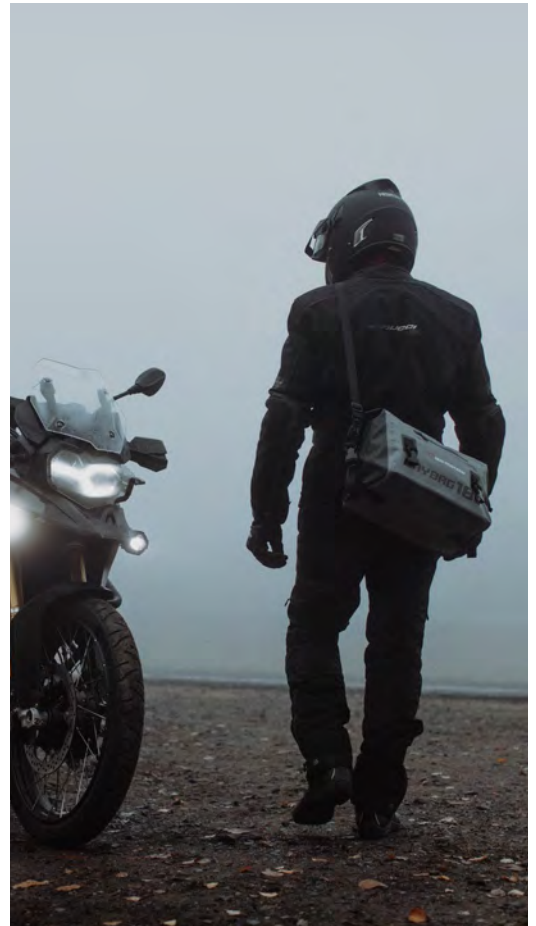

# DRYBAG 80

The Drybag 80 offers a unique level of versatility: Not only can it be used as a convenient shoulder bag, it can be attached to the Drybag 700, used as a tank bag, a tail bag or a crash bar bag up front.

## INCLUDED IN DELIVERY

Drybag 80 tail bag, steering head strap, 2 loop straps, shoulder strap



8 l 19.0 x 9.0 x 35.0 cm 500 g

Drybag 80 tail bag

BC.WPB.00.010.10001

60 €

Will it fit your motorcycle? Use the bike filter on [sw-motech.com](https://www.sw-motech.com)

## TIP:

The Drybag 80 fits many of the crash bars from the SW-MOTECH range. Select your motorcycle model using the bike filter and find out whether it fits your crash bar.

[more at sw-motech.com](https://www.sw-motech.com)

## MATERIAL & FUNCTION

- Made of durable 500D polyester with double-sided coating
- Multifunctional use as a tail bag, tank bag, crash bar bag or shoulder bag
- Waterproof roll closure



# ACCESSORIES

## DRYPACK STORAGE BAGS

From water sports on the motorcycle: The waterproof bags can be stowed in luggage as well as lashed separately. For this reason the Drybags have a lug on the base.

Drybag storage bag 20 l	BC.WPB.00.016.10000	15 €
Drybag storage bag set 4/8/13 l	BC.WPB.00.017.10000	30 €



## ROK™ STRAPS

The tough and long-lasting ROK™ straps are elastic and provide secure hold for luggage. The straps can be fastened almost anywhere and adjusted for length using the buckle.

The straps and hardware have smooth edges to prevent scratches.

ROK™ Straps 2 x 310 - 1,060 mm	BC.ROK.00.711.10000/B	20 €
ROK™ Straps 2 x 500 - 1,500 mm	BC.ROK.00.711.10100/B	25 €

## CABLE LOCK FOR MOTORCYCLE LUGGAGE

Anti-theft protection for when you're on the road: the cable lock helps secure a tank bag or tail bag to the motorcycle. The 180 cm long cable is simply passed through the frame and lock eyelet and then the lock attaches to the zipper and/or D-ring.

BC.LOC.00.002.10100/B	16 €
-----------------------	------



## LOCK FOR MOTORCYCLE LUGGAGE

The lock for motorcycle luggage hooks into the zipper eyelets, thus securing the contents of any SW-MOTECH luggage with zipper openings.

BC.LOC.00.001.10200/B	7 €
-----------------------	-----



# SIDE CASES

<b>TRAX ADV</b>	<b>134</b>
<b>ACCESSORIES TRAX SIDE CASE</b>	<b>138</b>
<b>AERO ABS SIDE CASES</b>	<b>142</b>
<b>URBAN ABS SIDE CASES</b>	<b>144</b>

# ALUMINUM POWER

## A ROBUST COMPANION FOR ANY ADVENTURE

No matter if you're on a long or short-distance tour, TRAX side cases are suitable for adventures big and small. In just two movements, they can be attached to the removable PRO or EVO side carriers and can also be secured with a lock. Adapter kits are also available for mounting the case on carriers from other manufacturers.

## CASES WITH AN EXTRA DOSE OF CONVENIENCE

The deep-drawn lid is additionally reinforced with beading. Open one side or remove the lid entirely for easier loading. Sturdy aluminium handles make it easy to carry the cases and mount them on the vehicle. In addition, four wide lashing points integrated into the lid design provide a secure hold for additional luggage.



Glass fiber-reinforced plastic corner caps give an extra degree of protection in case of ground contact



Lashing points integrated into the lid design allow the attachment of a tent or accessory bag



SW-MOTECH

**WELL DESIGNED — EVEN IN THE SMALLEST DETAILS**

Small features have a big impact: Thanks to a specially designed membrane, the cases can easily be opened even after large changes in pressure and temperature.

The extensive range of accessories completes the attractive offer: lock sets with matching keys, accessory bags and solutions for the interior and exterior, holders for water bottles and fuel canisters, leave nothing to be desired.



**WATER AND DIRT DON'T STAND A CHANCE**

The robust TRAX ADV side cases are 100% dustproof and waterproof thanks to robot-assisted welding, punch rivet technology and replaceable seals. And every one of our cases has to prove that in our final quality assurance testing.



The lid can be opened on one side or completely removed

# TRAX ADV

A touring case without compromise: Strength, protection from the elements and ease of use were the focus of the TRAX ADV case development. A practical carrying handle, a completely removable lid, glass fiber reinforced plastic corner caps and a large chamfer for cornering clearance are just some of the smart features. Here, veteran motorcyclists have developed a premium aluminium case that overcomes any challenge.

## INCLUDED IN DELIVERY

TRAX ADV side case, lid limiter, storage bag



37 l 49.0 x 37.0 x 23.0 cm 5,100 g

TRAX ADV M – left, black	ALK.00.733.11000L/B	390 €
TRAX ADV M – right, black	ALK.00.733.11000R/B	390 €
TRAX ADV M – left, silver	ALK.00.733.11000L/S	390 €
TRAX ADV M – right, silver	ALK.00.733.11000R/S	390 €

Will it fit your motorcycle? Use the bike filter on [sw-motech.com](http://sw-motech.com)

45 l 49.0 x 37.0 x 28.0 cm 5,500 g

TRAX ADV L – left, black	ALK.00.733.10000L/B	390 €
TRAX ADV L – right, black	ALK.00.733.10000R/B	390 €
TRAX ADV L – left, silver	ALK.00.733.10000L/S	390 €
TRAX ADV L – right, silver	ALK.00.733.10000R/S	390 €

Will it fit your motorcycle? Use the bike filter on [sw-motech.com](http://sw-motech.com)

## MATERIAL

- Sturdy and watertight side case made from aluminium
- Protection against oxidation and abrasion with powder coating (black model) or anodizing (silver model)

## FUNCTION

- Large cutaways on outer corners for plenty of ground clearance for cornering, additional protection from glass fiber reinforced plastic corner caps
- Robot-guided welding and self-piercing riveting keeps out the wet
- Even when loaded, the lid is completely removable with the quick-release fastener
- 4 large tie-downs integrated into the cover design allow for external lashing of an accessory bag, tent or other gear
- High strength and stability thanks to the embossed patterns, welded edges and pre-installed retaining rail
- Hinges made from stainless steel, handles made from anodized aluminum
- Exchangeable cover gasket

## REQUIRED FOR MOUNTING:

PRO side carrier

> [more on page 150](#)

Adapter kit

> [more on page 154](#)

Accessories

> [more on page 138](#)

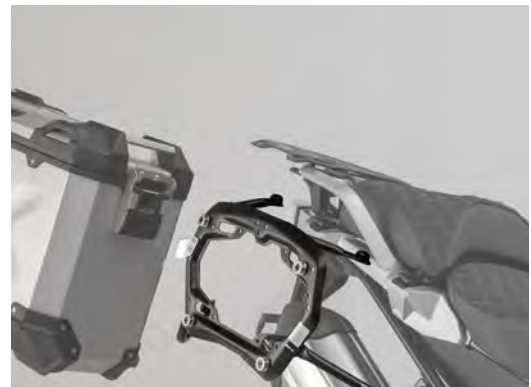

The PRO side cases provide secure support for the side case



The lid can be opened on one side or completely removed

# ACCESSORIES

## TRAX SIDE CASE



## TRAX BOTTLE/CANISTER KIT

For when the bike or the rider needs a refuel. A TRAX bottle kit or TRAX canister kit can be attached using an accessory mount. The TRAX accessory mount (sold separately) is first bolted to the back of the case.

The TRAX bottle kit, available with one or two bottles, or the canister kit holding plate are then easily snapped in place. The stainless-steel bottles or the 2-liter canister are secured by two lashing straps and are quickly at hand when needed.

TRAX canister kit	ALK.00.165.31100/B	50 €
TRAX bottle set. Including bracket, 1 bottle	ALK.00.165.30700/S	35 €
TRAX bottle set. Including bracket, 2 bottles	ALK.00.165.30800/S	50 €



## TRAX M/L EXPANSION BAG

Weatherproof, robust and flexible: The TRAX M/L accessory bag can be lashed to aluminum side cases from SW-MOTECH or other brands. It offers 15 liters of additional waterproof and dustproof storage space that can be reached quickly without opening the cases.

The large compartment with a circumferential, waterproof zipper and an additional overlapping lid allows quick access to the entire contents of the bag. The interior is padded and can be individually organized via dividers.

BC.ALK.00.732.10700/B

80 €





## TRAX M/L INNER BAG

The padded TRAX M/L inner bag protects even delicate luggage from vibrations and wear. A zipped lid compartment offers additional storage space for your wallet, smartphone or vehicle documents. When you arrive at your destination, it can be used as a comfortable travel bag thanks to its long handle bands.

BC.ALK.00.732.10000/B

50 €



## TRAX LOCK SET

The SW-MOTECH locking system consisting of 6 matching locks and 2 keys is suitable for all TRAX aluminum cases from the TRAX ION and TRAX ADV series.

TRAX lock set. 6 locks / 2 keys

ALK.00.165.16303

22 €



## TRAX ADV M/L LID INNER POCKET

Vehicle papers and important documents are safe and sound here. The padded inner lid pocket has mesh compartments and, thanks to the well-designed zipper system, gives quick access to the contents of the bag.

BC.ALK.00.732.10100/B

35 €



# ACCESSORIES

## TRAX SIDE CASE

<b>TRAX</b>			
TRAX lock set	6 locks/2 keys. Matching locks	ALK.00.165.16303	22 €
TRAX lock set	2 locks/2 keys. Matching locks.	ALK.00.165.16503	11 €
TRAX M/L inner bag	For TRAX side case. With volume expansion. Black.	BC.ALK.00.732.10000/B	50 €
TRAX M inner bag	For TRAX M side case. Waterproof. Black.	BCK.ALK.00.165.11000/B	30 €
TRAX L inner bag	For TRAX L side cases. Waterproof. Black.	BCK.ALK.00.165.10000/B	30 €
TRAX M/L expansion bag	For TRAX/BMW/other side cases. Black. 15 l.	BC.ALK.00.732.10700/B	80 €
TRAX accessory mount	For TRAX side case. Silver.	ALK.00.165.30900/S	35 €
TRAX bottle set 1	For TRAX accessory mount. Including 0.6l bottle, bracket.	ALK.00.165.30700/S	35 €
TRAX bottle set 2	For TRAX accessory mount. Including 2x 0.6l bottle, bracket.	ALK.00.165.30800/S	50 €
TRAX bottle	Stainless steel. Silver. 60 l.	ALK.00.165.31000/S	17 €
TRAX canister kit	For TRAX accessory mount. Including 2 l canister, bracket.	ALK.00.165.31100/B	50 €
TRAX canister	Plastic. Black. 2 l.	ALK.00.165.31200/B	20 €
<b>TRAX ADV</b>			
TRAX ADV M lid net	For TRAX ADV M side cases. Black	BC.ALK.00.732.10400/B	15 €
TRAX ADV L lid net	For TRAX ADV L side cases. Black.	BC.ALK.00.732.10500/B	15 €
TRAX ADV M/L inner lid bag	For TRAX ADV side case. 600D polyester. Black.	BC.ALK.00.732.10100/B	35 €



# AERO ABS SIDE CASES

Aerodynamic style, low weight, comfortable details: AERO ABS side cases impress with their streamlined shape and modern, particularly easy-care surface. These side cases made of heavy-duty ABS material offer 25 liters of storage on each side with a net weight of just 1.8 kg. Together with the removable PRO or EVO side carriers, they are the ideal luggage solution for sport motorcycle travelers.

## INCLUDED IN DELIVERY

Set: 2 AERO ABS side cases, 2 waterproof inner bags, 2 locks for motorcycle luggage



 25 l  52.0 x 39.0 x 22.0 cm  1,800 g

AERO ABS side case set BC.HTA.00.675.12000/B **330 €**

AERO ABS side case system including carriers & adapters **starting at 530 €**

**Will it fit your motorcycle? Use the bike filter on [sw-motech.com](http://sw-motech.com)**

## REQUIRED FOR MOUNTING:

PRO side carrier

[> more on page 150](#)

Adapter kit

[> more on page 154](#)



## MATERIAL

- Made of heavy-duty, weather- and UV-resistant 2.5 mm (inner shell) and 2 mm (outer shell) ABS material
- Structured surface is easy to care for, scratch-resistant and lends the AERO ABS side cases a modern look

## FUNCTION

- 25 liter storage per case, weighing just 1.8 kg when empty
- Secure attachment via quick-release fastener to removable PRO or EVO side carriers from SW-MOTECH
- Plush interior: padded textile lining, elastic criss-crossing straps, mesh pocket, dedicated pocket for stowing case lock
- Theft protection: Case locks to carrier, lockable zipper, Case lock is included with purchase
- Reflective details for more safety in traffic
- Waterproof inner bag included in delivery
- Carrying handles allow for carrying two cases with one hand
- Lid limiter with snap closures secures the contents of the case



Integrated anti-theft protection for securing to side carrier



Robust carrying handle

# URBAN ABS SIDE CASES

Hard shell, aerodynamic shape: Thanks to the light yet robust URBAN ABS cases, you can quickly turn a street bike into a touring motorcycle. URBAN ABS cases can be attached securely to the SLC side carrier via the quick-release fastener featuring integrated anti-theft protection in one swift move. These compact cases made of ABS plastic combine low weight with extra load-bearing capacity, underline the bike's dynamic design and only have a minimal impact on the driving characteristics.

## INCLUDED IN DELIVERY

Set: 2 AERO ABS side cases, 2 waterproof inner bags, 2 locks for motorcycle luggage



 25 l  52.0 x 39.0 x 22.0 cm  1,800 g

URBAN ABS side case set BC.HTA.00.67710000/B 280 €

URBAN ABS side case system including carriers & adapters starting at 230 €

Will it fit your motorcycle? Use the bike filter on [sw-motech.com](http://sw-motech.com)

## REQUIRED FOR MOUNTING:

SLC side carrier

[> more on page 152](#)



## MATERIAL

- Durable, robust and lightweight thanks to the 2.5 mm (inner shell) and 2 mm (outer shell) 2.5 mm thick ABS material
- The structured surface is easy to clean and scratch resistant

## FUNCTION

- Lightweight side cases for sport motorcycles
- Secure mounting to the SLC side carrier via a quick-release fastener
- Criss-crossing straps and lid limiter with snap buckles secure case contents
- Removable, waterproof inner bag
- Reflective details for more safety in traffic
- Anti-theft protection thanks to protection on the SLC side carrier and lockable zippers
- Available individually, as a set or as a system including one or two SLC side carriers



Elastic criss-crossing straps with snap buckles



Both cases can be carried in one hand



# SIDE CARRIERS

PRO SIDE CARRIERS	150
TRAX TOOLBOX	151
SLC SIDE CARRIERS	152
SIDE CARRIER ACCESSORIES	154

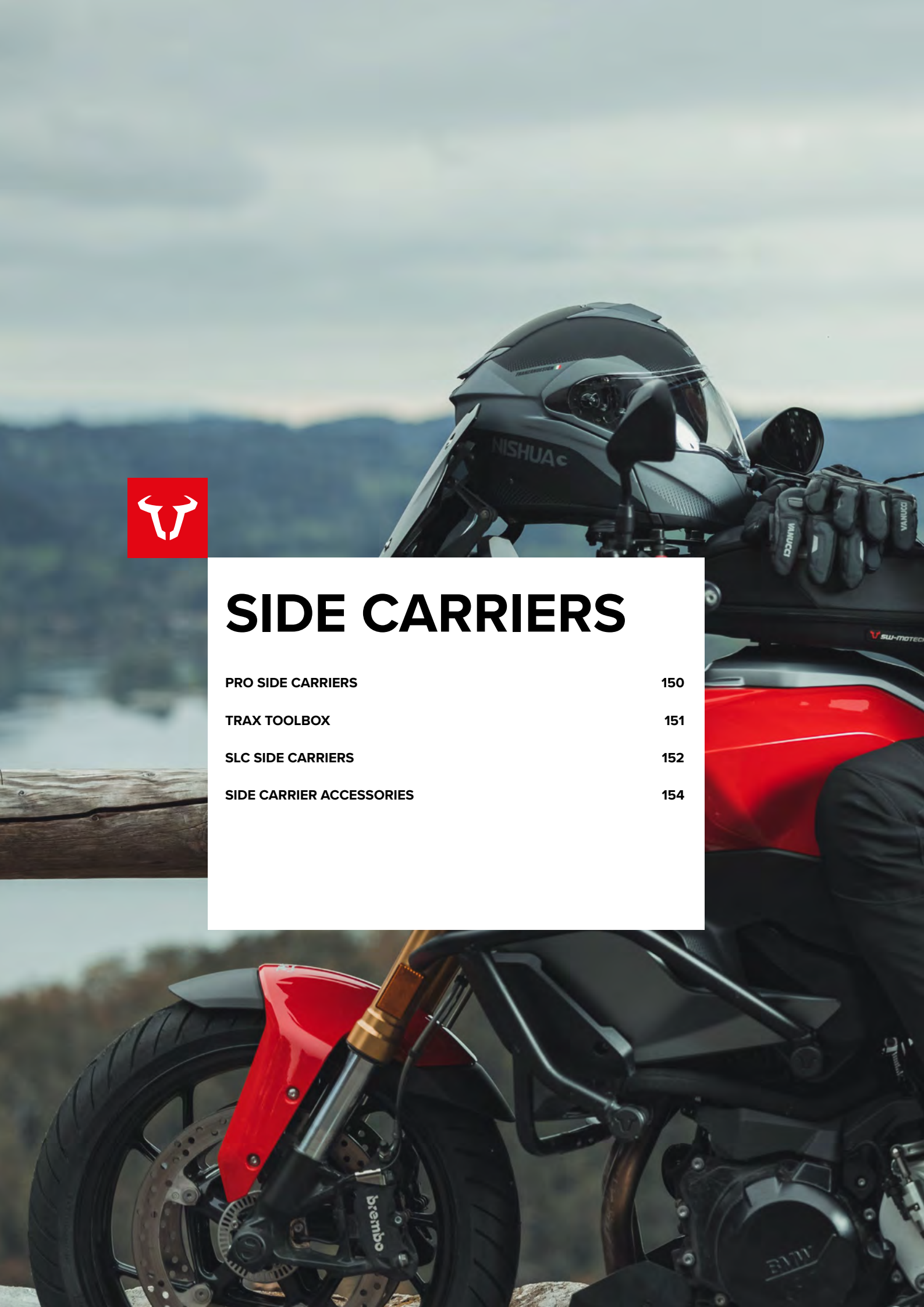

# PASSION FOR INNOVATION

Much has changed since the initial development of QUICK-LOCK: The world's first removable carrier. We've updated to more robust materials, evolved our production technologies and there's even been new names. However, one thing remains the same: The dedication we show in developing every one of our side carriers. This product is a labor of love for us. This is the first product our founders developed, so there is history behind it. Or maybe it's because we go back to the drawing board for every single motorcycle in our workshop: Where are the right mounting points? What is the best shape for the side carrier to fit perfectly? And what type of carrier even makes sense for this motorcycle?

The bike-specific development of side carriers is both a blessing and a curse. It requires additional expertise but also offers many advantages at the same time. With the correct side carrier on your bike, luggage will be mounted exactly the way that works best for you and your specific bike.

Regardless of the type of trip you are on, you'll get the reliability, precision fit and outstanding appearance you expect for your luggage system.



Cases can be secured to the side carrier using a lock.



The side cases clip securely and easily into the four retention spools mounted on the carrier.



The EVO and PRO side carriers can be completely removed in seconds. Simply release the QUICK-LOCKS with a quarter turn, then only the small mounting tab components remain on the bike.



For the past 20 years, our products have progressed alongside increasingly complex and specialized motorcycles. On the street or far from marked roads, discreet or functional—we build side carriers suited for every purpose.

We weld over 250 different steel side carriers at our plant in the Czech Republic and currently offer specific carriers for more than 300 models of motorcycle.

And the journey is not over. Many more motorcycles will be brought to market and we will equip them with the right carriers. We analyze each bike. Then we design, test and develop each bike's carriers. That is how it was 20 years ago and how it still is to this day.



# PRO SIDE CARRIERS

Even more robust, even more adventurous, yet still removable: The bike-specific PRO side carrier made of 2.5 mm thick steel is extremely resilient and designed to fit closer to the bike.

In the course of the new production, the popular QUICK-LOCK quick-release fasteners were redesigned as well. The entire carrier can be removed in a matter of seconds, leaving only the inconspicuous attachment points.

## INCLUDED IN DELIVERY

2 PRO side carrier, mounting material



PRO side carrier

starting at 200 €

Will it fit your motorcycle? Use the bike filter on [sw-motech.com](https://www.sw-motech.com)

## ADAPTER KITS

The PRO side carrier can be combined with TRAX ADV, AERO ABS cases, SysBag WP L and various cases made by other manufacturers. Prepared mounting points makes it easy to attach the correct adapter kit. [> more on page 154](#)

## MATERIAL

- Extremely durable: Optimized shape and 2.5 mm thick steel.
- Black powder coating protects against corrosion.

## FUNCTION

- Simple assembly at the original mounting points.
- Fully removable with all new, even more robust QUICK LOCK fasteners.
- For permanent assembly, the quick-release fasteners can be replaced by conventional hardware.
- Combine with an SW-MOTECH rear rack for even more storage.
- Adapter kits are available for SW-MOTECH hard cases, SysBag WP L, Givi/Kappa, Krauser and Shad.



Designed to fit close as possible to each bike.



Numerous functional holes, various adapter kits available



[Discover more on our YouTube channel!](#)



# TRAX TOOLBOX

Whether a set of keys, warning vest, first aid kit or smaller spare parts: Everything has its place in the massive TRAX Toolbox and is easy to reach if the worst comes to the worst.

The TRAX toolbox is attached to the inside or outside of the PRO side carrier. The position can be variably adjusted using the three attachment points, so the box can be placed under almost any motorcycle rear. The sealed plastic lid can be fixed to the main body with a simple twist lock. .

## INCLUDED IN DELIVERY

1 TRAX Toolbox, mounting material

 3.3 l  28.0 x 19.0 x 11.0 cm  1,110 g

TRAX Toolbox black	KFT.00.152.30300/B	140 €
TRAX Toolbox silver	KFT.00.152.30300/S	140 €

Will it fit your motorcycle? Use the [bike filter on sw-motech.com](https://www.sw-motech.com)

## MATERIAL

- Made from robust 1.5 mm thick aluminium
- Available in natural anodized or black powder coated

## FUNKTION

- For mounting on the PRO side carrier
- Splash-proof
- Sealed plastic lid
- Expandable with TRAX lock set
- Volume: 3.3 liters



## PRO TIP

The TRAX Toolbox is suitable for mounting on the PRO side carrier. The positioning of the toolbox on the side carrier is variably adjustable.



Sealed plastic lid



For mounting on the PRO side carrier

# SLC SIDE CARRIERS

The precise, bike-specific design of the SLC side carriers allows for simple and easy luggage mounting. Side bags can be attached and removed in seconds via the quick-lock system. The SLC carrier provides a secure hold for a range of case options including the Legend Gear LC1/LC2 side bags, the URBAN ABS side cases and the versatile SysBag systems with an adapter plate.

## INCLUDED IN DELIVERY

SLC side carrier (right or left), mounting hardware.



SLC side carrier	starting at 75 €
SLC side carrier set	starting at 140 €
Will it fit your motorcycle? Use the bike filter on <a href="https://www.sw-motech.com">sw-motech.com</a>	

## MATERIAL & FUNCTION

- Made of powder-coated steel tubing.
- Side carrier adapts perfectly to your motorcycle's look.
- Bike-specific shape makes mounting easy on one or both sides.
- Compatible with Legend Gear LC1/LC2 side bags, URBAN ABS side cases, SysBag WP S and M with adapter plate, universal side bracket, number plate.
- Adapter kit included..



Bike-specific design for best fit.



Simple quick lock system.



[Discover more on our YouTube channel!](#)

## LUGGAGE SOLUTIONS FOR THE SLC SIDE CARRIER



### URBAN ABS SIDE CASE

The aerodynamic URBAN ABS side cases blend into the lines of any type of bike. These lightweight and durable rigid plastic bags work great on sportbikes, naked streetfighters or enduro machines.

> [more on page 144](#)

### SYSBAG WP

The Sysbag WP S and M transport your luggage safely protected from water and dust. They are perfectly suited for offroad adventures.

> [more on page 78](#)



### LEGEND GEAR SIDE BAGS LC1/LC2

Designed with a distinctive retro-classic look, these Legend Gear soft bags are made of heavy-duty canvas and Napalon imitation leather.

Stylish, simple, functional and reliable.

Removable inner waterproof liner included. Also available in a Black Edition.

> [more on page 91](#)

# ACCESSORIES

## FOR SIDE CARRIERS



## ADAPTER KIT FOR PRO SIDE CARRIER

The PRO side carrier is also incredibly versatile when combined with adapter kits. Adapter kits are available for TRAX and AERO ABS side cases. With the correct adapter plate, they also work with SysBags 15/30 and even other manufacturers' cases.

Prepared attachment points allow easy mounting of the adapter kit. Four retention lugs and a latch buckle are used to mount TRAX aluminum cases.

Side carrier accessories

starting at 25 €

## ADAPTER KITS FOR OTHER CARRIERS

TRAX aluminum cases can be used in combination with side carriers by SW-MOTECH and many other configurations. Adapter kits were also developed for the original carriers of the BMW R1200 GS LC Adventure and for Givi carriers.

Once the adapter kit is mounted on the carrier, TRAX ADV, ION or EVO aluminum cases can then be attached. When changing motorcycles, all you need is a side carrier set from SW-MOTECH and an adapter kit. The rugged TRAX aluminum cases are true companions and you can just keep on using no matter what bike you may move to.

Adapter kit for orig. BMW carrier	KFT.00.152.10900/S	110 €
Adapter kit for Givi carrier	KFT.00.152.10700/B	70 €

Will it fit your motorcycle? Use the bike filter on [sw-motech.com](http://sw-motech.com)



<b>ADAPTER KITS FOR PRO SIDE CARRIER</b>			
Adapter kit for PRO side carrier	For TRAX ADV/EVO/ION, NANUK side cases. For 2 cases.	KFT.00.152.35100	25 €
Adapter kit for PRO side carrier	For AERO ABS side cases. For 2 cases.	KFT.00.152.35200	25 €
Adapter kit for SysBag	For 1 adapter plate for SysBag 10/15/30. For PRO side carrier, EVO carrier. For STREET-RACK, ADVENTURE-RACK and ALU-RACK.	SYS.00.001.13000	12 €
Adapter kit for PRO side carrier	For Givi/Kappa with Monokey. For 2 cases.	KFT.00.152.35400	30 €
Adapter kit for PRO side carrier	For Krauser K-Wing, Hepco & Becker C-Bow side cases. For 2 cases. C-Bow not included.	KFT.00.152.35600	45 €
Adapter kit for PRO side carrier	For Shad I side cases and top case. Used for mounting 2 cases.	KFT.00.152.35700	45 €
Adapter kit for PRO side carrier	For Shad II side cases and top case. Used for mounting 2 cases.	KFT.00.152.35800	55 €
Adapter kit for PRO side carrier	For Rotopax. For mounting 1 canister. RotopaX bracket not included.	KFT.00.152.35900	35 €
Adapter kit for PRO side carrier	For SLC side carrier. Mounting of 2 bags.	KFT.00.152.36500	50 €
<b>ADAPTER KITS FOR EVO SIDE CARRIER</b>			
Adapter kit for EVO carrier	For TRAX ADV/ EVO/ ION, NANUK. For 2 cases.	KFT.00.152.200	25 €
Adapter kit for EVO carrier	For AERO ABS side cases. For 2 cases.	KFT.00.152.22500/B	25 €
Adapter kit for EVO carrier	For Givi/Kappa Monokey. For 2 cases.	KFT.00.152.205	25 €
Adapter kit for EVO carrier	For Givi Trekker. For 2 cases. Not for the Outback/ V35, Dolomiti.	KFT.00.152.20500/B	25 €
Adapter kit for EVO carrier	For Krauser with K-Wing (Wing not included) For 2 cases.	KFT.00.152.220	45 €
Adapter kit for EVO carrier	For Shad. Mounting for 2 cases. Not for the 3P System.	KFT.00.152.215	45 €
Adapter kit for EVO carrier	For Hepco & Becker. For 2 plastic cases.	KFT.00.152.210	45 €
<b>ADAPTER KITS FOR SIDE CARRIERS BY OTHER MANUFACTURERS</b>			
Adapter kit for orig. carrier R1200/1250GS,F850GS	For TRAX ADV/ION/EVO. For 2 cases.	KFT.00.152.10900/S	110 €
Adapter kit for orig. R1200GS Adv. carrier	For TRAX ADV/EVO. For 2 cases.	KFT.00.152.10801/S	80 €
Adapter kit for Givi carrier	For TRAX ADV/EVO/ION side cases. For 2 cases.	KFT.00.152.10700/B	70 €
<b>ACCESSORIES FOR SLC SIDE CARRIERS</b>			
Universal side bracket left	For SLC side carrier left. Incl. Net.	HTA.00.401.15100	70 €
Universal side bracket right	For SLC side carrier right. Incl. Net.	HTA.00.401.15200	70 €
Number plate	For SLC side carrier left.	HTA.00.401.15300	55 €
Number plate	For SLC side carrier right.	HTA.00.401.15400	55 €
<b>ACCESSORIES FOR PRO/EVO SIDE CARRIERS</b>			
Anti-theft protection for PRO side carrier	QUICK-LOCK. 2 locks and 2 keys. Interchangeable.	QLS.00.095.10000/B	45 €
Anti-theft protection for EVO carrier	QUICK-LOCK. 2 locks and 2 keys. Interchangeable.	QLS.00.046.10100/B	45 €
TRAX Toolbox	Tool box. Aluminum. 3.3 l. Black.	KFT.00.152.30300/B	140 €
TRAX Toolbox	Tool box. Aluminum. 3.3 l. Silver.	KFT.00.152.30300/S	140 €



# TOP CASES

<b>TRAX ADV</b>	<b>158</b>
<b>TOP CASE ACCESSORIES</b>	<b>162</b>
<b>URBAN ABS TOP CASES</b>	<b>164</b>



# TOP OF THE LINE

Some love it, others hate it – the topcase. We build our TRAX ADV top case for everyone who loves it.

It's stable, dust and waterproof, is easy to handle and offers enough storage for long tours. We developed the TRAX ADV top case to go with the TRAX ADV side cases and we build it to the same high standards of quality.

## IT STAYS SEALED

The 1.5-mm aluminum sheet is shaped in our plant in the Czech Republic before it is made into a top case in Rauschenberg. Every top case is welded using robot assistance and tested for 100% tightness. It's not a genuine TRAX ADV top case until that's done. Thanks to a special membrane, opening the top case is child's play, even after significant changes in pressure and temperature.



A lock in the latch buckle secures the top case against theft



The latch buckle lets you quickly and securely attach your top case



Simple attaching to the retaining  
cams of the ADVENTURE-RACK



#### **THAT IS WELL-DESIGNED**

The TRAX ADV top case offers room for 38 liters worth of luggage and you can even comfortably stow your helmet here. We have built in stable aluminum handles into the lid for easier carrying and straightforward mounting. The lashing points directly next to the handles allow for additional luggage to be mounted, and we offer the right matching lock set so you can combine this with the TRAX ADV side cases.

#### **THAT FITS ON THE BIKE**

You can choose from a silver anodized design or the black powder-coated design. The solid ADVENTURE-RACK made from 4-mm thick aluminum alloy is a great choice for mounting it (page 168). When buying, make sure to select the ADVENTURE-RACK that fits your bike model. Or just get the top case in a set with the matching rack.





# TRAX ADV TOPCASE

The TRAX ADV top case is the premium luggage solution for the tail and is roadworthy but also suitable for off-road use. The robust aluminum cases boast the same quality features that distinguish the series' side cases and are ideal counterparts. The lockable top case offers 38 liters of storage and easily holds a motorcycle helmet.

## INCLUDED IN DELIVERY

TRAX ADV top case, lid limiter, storage bag



38 l 41.0 x 34.0 x 33.0 cm 4,800 g

TRAX ADV top case, black ALK.00.733.15000/B 380 €

TRAX ADV top case, silver ALK.00.733.15000/S 380 €

TRAX ADV top case system starting at 500 €

Will it fit your motorcycle? Use the bike filter on [sw-motech.com](http://sw-motech.com)

## REQUIRED FOR MOUNTING:

Racks

> [more on page 168](#)

TRAX lock set

> [more on page 162](#)

TRAX ADV side cases

> [more on page 136](#)



## THE COMPLETE SOLUTION

The TRAX ADV top case system encompasses all products needed for mounting a top case: TRAX ADV top case, bike specific rack, adapters and TRAX lock set.

## MATERIAL

- Premium top case made from 1.5 mm-thick aluminum
- Protection against oxidation and abrasion with powder coating (black model) or anodizing (silver model)
- Additional protection on corners made of glassfiber-reinforced polyamide

## FUNCTION

- Hinged lid with limiter stay, stainless steel latch, sturdy carrying handles and integrated mounting points
- 100% water and dustproof due to robotic welding and punch rivet technology
- Theft protection: Case lid and case can be locked when on the carrier
- High strength thanks to the visually appealing and functional embossed sheet metal



Easy to attach to ADVENTURE-RACK



Separately available cargo net in the case lid

# ACCESSORIES

## FOR TOP CASES



### TRAX ADV TOP CASE LID NET

Everything quickly at hand: Papers or rain suit at the ready when they are stored in the lid net of the TRAX ADV top case. Our aluminium cases offer plenty of storage – so keeping everything organized is more important than ever. The lid net, available for the top case and side cases of the TRAX ADV series, is a proven solution. The highly flexible netting is suspended from the lid interior. This easily accessible storage is now available for gear.

BC.ALK.00.732.10600/B

15 €

## TRAX TOP CASE INNER BAG – PADDED

Who wants to haul luggage after a challenging tour? Thanks to the carrying handle, the padded TRAX top case inner bag can be easily removed from the case and the touring luggage becomes a travel bag. The large opening allows quick access to the bag contents and a non-slip, sturdy underside guarantees secure positioning on any surface.

BC.ALK.00.732.10300/B

50 €



### TRAX TOP CASE INNER BAG

This waterproof inner bag, made of black tarpaulin is specially cut for the TRAX top case 38 liters and offers additional protection from water.

BCK.ALK.00.165.15000/B

30 €

<b>TRAX</b>			
TRAX lock set	6 locks/2 keys. Matching locks	ALK.00.165.16303	<b>22 €</b>
TRAX lock set	2 locks/2 keys. Matching locks.	ALK.00.165.16503	<b>11 €</b>
TRAX top case inner bag	For TRAX top case. Water resistant. Black.	BC.ALK.00.732.10300/B	<b>50 €</b>
TRAX top case inner bag	For TRAX top case. Waterproof. Black.	BCK.ALK.00.165.15000/B	<b>30 €</b>
<b>TRAX ADV</b>			
TRAX ADV top case passenger backrest	For TRAX ADV top case. Black.	ALK.00.732.10200/B	<b>65 €</b>
TRAX ADV top case lid net	For TRAX ADV top case. Black.	BC.ALK.00.732.10600/B	<b>15 €</b>



# URBAN ABS TOP CASES

Sporty, lightweight and robust: The aerodynamic URBAN ABS top case with 16 to 29 liters volume is just the right size for short, everyday trips or leisure rides, and even holds a helmet.

The particularly plush model of the URBAN ABS top case is easily attached to the STREET-RACK using the DHV system, a newly developed quick-release fastener. An adapter kit is required for installing on the ADVENTURE-RACK. Alternatively, the top case is also available as a tie-down model.

## INCLUDED IN DELIVERY

URBAN ABS top case, DHV system for STREET-RACK / ADVENTURE-RACK or bottom insert for tie-down model, waterproof inner bag, lock for motorcycle luggage, 4 loop straps

 16 – 29 l  40.5 x 21.5 x 36.0 cm  2,300 g

URBAN ABS top case for STREET-RACK / ADVENTURE-RACK BC.HTA.00.677.21000/B 200 €

URBAN ABS top case system (incl. STREET-RACK / ADVENTURE-RACK) starting at 265 €

URBAN ABS Topcase lashing version BC.HTA.00.677.22000/B 180 €

Will it fit your motorcycle? Use the bike filter on [sw-motech.com](http://sw-motech.com)

## MATERIAL & FUNCTION

- Durable, robust and lightweight due to the 2.5mm (bottom) and 2mm (top) thick ABS plastic
- Lightweight top case for sport motorcycles, naked bikes and enduros
- Anti-theft protection by securing to the rack (only with DHV system), lockable zipper and lock for motorcycle luggage
- With the volume fully expanded, the URBAN ABS top case holds a helmet
- Reflective details



### TIP:

Simple attachment using quick-release fastener on the bike-specific STREET-RACK

> [more on page 170](#)



Enough space for a helmet



Robust carrying handle

**ANTI-THEFT PROTECTION**

The top case is easily and firmly attached to the carrier with a single push and can be additionally secured with the integrated anti-theft protection.

**FOR STREET-RACK AND ADVENTURE-RACK**

Attaches securely to the STREET-RACK or ADVENTURE-RACK with just one hand movement thanks to a user friendly quick-release fastener.

**URBAN ABS TOP CASE AS TIE-DOWN VARIATION**

A reliable 4-point mount with loop straps gives this variation of the URBAN ABS top cases secure hold on almost any motorcycle tail.

**NON-SLIP BASE INSERT**

The curved base insert made of foam rubber can be perfectly positioned on the seat and simultaneously serves a non-slip and vibration-damping function.



# RACKS

ADVENTURE-RACK	168
STREET-RACK	170
OTHER LUGGAGE SOLUTIONS	172

# ADVENTURE-RACK

Ready for big adventure: Our ADVENTURE-RACK proves itself with its extreme durability and function-oriented shape. More than 15 years of experience producing racks, combined with feedback from customers and test riders, went into the development of this aluminum rack. Material thickness, weight and geometry have been optimized for demanding tours and off-road use.

Developed specifically for enduros, large road and sports touring bikes, the ADVENTURE RACK offers a large contact surface, lots of big lashing eyelets and functional holes for attaching adapter kits for top cases from SW-MOTECH, Givi, Krauser and Shad or SysBags with adapter plate.



## INCLUDED IN DELIVERY

ADVENTURE-RACK, mounting hardware

ADVENTURE-RACK

starting at 120 €

Will it fit your motorcycle? Use the bike filter on [sw-motech.com](http://sw-motech.com)

## MATERIAL

- Made of light but sturdy 4mm-thick aluminum alloy
- Effective corrosion protection from black powder coating

## FUNCTION

- Its extreme durability during vibrations, impacts and heavy loads was tested in the lab and off-road under harshest conditions
- Easy installation on original attachment points with bike-specific attachment elements
- Multiple functional bores, compatible with adapter kits for top cases from SW-MOTECH, Givi/Kappa, Krauser and Shad
- Multiple large tie-down points



Adapter kits for the TRAX ADV top case and many other top cases

# ADAPTER KITS

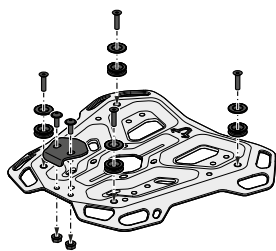

## FOR TOP CASES & SYSBAGS 15/30

The adapter kits are screwed directly onto the rack and thus ensure extremely stable support.

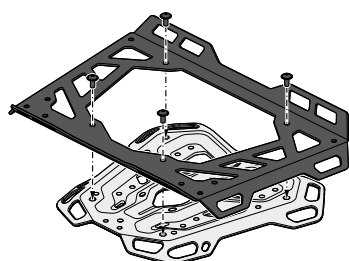

## EXTENSION FOR THE LASHING OF LUGGAGE

The extension further widens the already generous contact surface by around 30 percent to 45 x 30 cm.

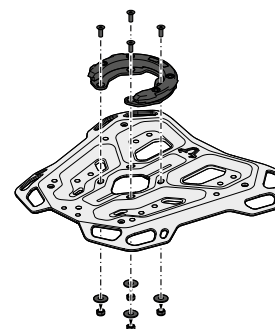

## FOR PRO TANK BAGS

This PRO tank ring also allows you to fasten PRO tank bags with a flat bottom onto the ADVENTURE-RACK.

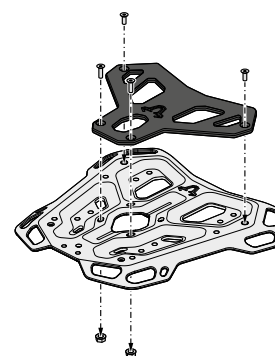

## FOR STREET-RACK ADAPTER PLATE

Simply screw it on and the multifunctional STREET-RACK adapter plate (page 152) can be locked in place.

### ADAPTER FOR PRODUCTS BY SW-MOTECH

For TRAX ADV, ION, EVO. Black/silver.	from page 134	GPT.00.152.35100/B	18 €
For PRO tank bags. Black. Micro, Daypack, Sport, Yukon WP	from page 48	GPT.00.152.36100/B	25 €
45x30 cm. Aluminium. Black. Also for adapter plate for STREET-RACK/ALU-RACK.		GPT.00.152.35500/B	55 €
Mounting the STREET-RACK adapter plate onto the ADVENTURE-RACK. Black.		GPT.00.152.35000/B	30 €

### ADAPTER FOR PRODUCTS FROM OTHER MANUFACTURERS

For Givi, Kappa with Monolock. Black.		GPT.00.152.35300/B	25 €
For Givi/Kappa Monokey. Black. Not compatible with MonoKey side system.		GPT.00.152.35400/B	25 €
For Krauser K-Wing, Hepco & Becker C-Bow. K-Wing/C-Bow not included. Black.		GPT.00.152.35600/B	25 €
For Shad. Black.		GPT.00.152.35700/B	25 €
For Shad 2. Black.		GPT.00.152.35800/B	30 €
For RotopaX. RotopaX mount not included. Black.		GPT.00.152.35900/B	25 €



# STREET-RACK

The compact STREET-RACK was developed specially for sporty motorcycles, naked bikes and smaller street bikes. The URBAN ABS top case or an adapter plate can be fixed to the rack in one step without any tools. The adapter plate offers a sturdy base for top cases from SW-MOTECH, Givi, Krauser and Shad or SysBags 15/30 with adapter plate.

The STREET-RACK is also suitable for lashing luggage when combined with the expansion with extra large contact surface, available separately. With our STREET-RACK, your bike is ready for the next long tour in a few simple steps.

## INCLUDED IN DELIVERY

STREET-RACK, mounting hardware



STREET-RACK

starting at 65 €

Will it fit your motorcycle? Use the bike filter on [sw-motech.com](https://www.sw-motech.com)

## MATERIAL

- Made of 5-mm thick aluminum alloy
- Black powder coating protects against corrosion

## FUNCTION

- Perfect fit due to bike specific attachments and high-precision CNC production processes
- Compact shape complements the lines of sporty motorcycles and small street bikes
- Simple assembly at the original mounting points



The STREET-RACK adapter plate offers mounting points for various adapter kits

# ADAPTER KITS

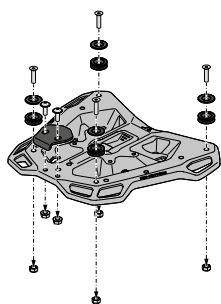

## FOR TOP CASES & SYSBAGS 10/15

The multifunctional adapter plate features functional holes for mounting various adapter kits.

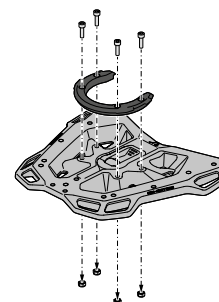

## FOR PRO TANK BAGS

The PRO tank ring for PRO tank bags can also be screwed onto the adapter plate.

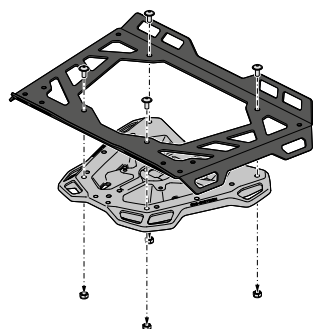

## EXTENSION FOR THE LASHING OF LUGGAGE

Extension with an extra large contact surface (45 x 30cm) for the lashing of tail bags.

Tip: Rackpack tail bag (page 104)

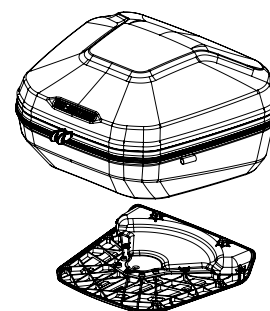

## URBAN ABS TOP CASE

The URBAN ABS top case (page 164) can be pushed directly onto the carrier and locked in place with a swift hand movement.

### ADAPTER FOR PRODUCTS BY SW-MOTECH

For TRAX top case ADV, ION, EVO. Black.	from page 134	GPT.00.152.54100/B	30 €
For PRO tank bags Micro, Daypack, Sport, Yukon WP. Including adapter plate.	from page 48	GPT.00.152.55200/B	50 €
For PRO tank bags Micro, Daypack, Sport, Yukon WP. Without adapter plate	from page 48	GPT.00.152.55300/B	30 €
45x30 cm. Aluminum. Black. With adapter plate.		GPT.00.152.54500/B	65 €
Baseplate. Without adapter kit for top case.		GPT.00.152.50000/B	25 €

### ADAPTER FOR PRODUCTS FROM OTHER MANUFACTURERS



For Givi/Kappa with Monolock. Black.		GPT.00.152.54300/B	30 €
For Givi/Kappa with Monokey. Black.		GPT.00.152.54400/B	30 €
For Krauser K-Wing, Hepco&Becker C-Bow. Black.		GPT.00.152.54600/B	40 €
For Shad. Black.		GPT.00.152.54700/B	40 €
For Shad 2. Black.		GPT.00.152.54800/B	40 €
For RotopaX. RotopaX mount not included. Black.		GPT.00.152.35900/B	25 €

# OTHER LUGGAGE SOLUTIONS



## DRYBAG 300 BACKPACK

The Drybag 300 is a real all-weather backpack: This durable bag protects up to 30 liter luggage from water and dirt and has an ergonomic carrying system. The Drybag is available in grey and signal yellow.

 30 l	 24.0 x 26.0 x 48.0 cm	 1,200 g
Drybag 300, grey	BC.WPB.00.011.10000	70 €
Drybag 300, yellow	BC.WPB.00.011.10000/Y	70 €

### MATERIAL & FUNCTION



- Made of waterproof polyester with coating
- Waterproof roll closure
- Padded shoulder and waist belt for wearing comfort and the best fit
- Splashproof outer pocket with zipper
- Reflective details



## DRYBAG 20 HIP PACK

The hip pack Drybag 20 only weighs 350 g and offers a safe place for valuables and smartphone. Made of rugged and easy-to-clean tarpaulin, this waterproof waist bag offers a compact size and comfortable fit.



 2 l	 350 g	
Drybag 20 hip pack	BC.WPB.00.005.10002	30 €

### MATERIAL & FUNCTION

- Made of waterproof polyester with coating
- Padded hip belt
- Front compartment with zipper
- Reflective details

## TRITON BACKPACK

The waterproof Triton backpack with 20 liters of volume is perfect for all weather conditions and offers a clever partitioning system and volume adjustment. The ergonomic carrier system with strap management makes the backpack a convenient companion for day tours.

 20 l  35.0 x 66.0 x 14.0 cm  1,200 g

Triton backpack

BC.WPB.00.004.10001

75 €





### MATERIAL & FUNCTION

- Made of waterproof polyester with coating
- Adjustable carrying system with padded waist strap
- Roll closure
- Outer pocket with zipper
- Adjustable volume compression
- Organizer compartments, padded laptop holder
- Reflective details

## BARACUDA BACKPACK

The waterproof, multi-functional Baracuda backpack with its easy-to-clean tarpaulin outer shell reliably protects up to 25 liters of luggage from water and dirt. Aside from numerous storage compartments, the padded interior also has a 17" laptop compartment. At the same time, the completely adjustable, padded belt system of the motorcycle backpack increases comfort and reflective details make you more visible in traffic.



 25 l  38.0 x 73.0 x 21.0 cm  1,600 g

Baracuda Backpack

BC.WPB.00.003.10001

90 €

### MATERIAL & FUNCTION

- Made of waterproof polyester with coating
- Adjustable carrying system with padded waist strap
- Roll closure
- Outer pocket with zipper
- Adjustable volume compression
- Organizer pockets, padded laptop compartment
- Reflective details

## FLEXPACK BACKPACK

Folded up, the Flexpack is as big as a fist and fits in a tank bag or under the seat. If required, this little helper can be instantly transformed into a 30-liter backpack that can also hold a helmet



30 l 22.0 x 50.0 x 22.0 cm 200 g

Flexpack backpack	BC.WPB.00.019.10000	20 €
-------------------	---------------------	------

### MATERIAL & FUNCTION

- Made of 75D ripstop polyester with water resistant coating
- Lightweight and extremely compact when folded
- Holds a motorcycle helmet

## LEG BAG-SET WITH LA8

Going for a short ride? What do you do with your wallet, keys and phone if you don't have any luggage? With the retro-style Legend Gear leg bag, you can wear the most important things directly on your body.

### INCLUDED IN DELIVERY

Set: Legend Gear leg bag LA8, Legend Gear holster LA7, rain hood, instructions

1.25 l 13.0 x 19.5 x 5.0 cm 170 g

Legend Gear holster LA7	BC.TRS.00.409.10000	20 €
Legend Gear leg bag LA8	BC.TRS.00.410.10000	30 €
Legend Gear leg bag-set with LA8	BC.TRS.00.409.50000	50 €



### MATERIAL & FUNCTION

- Secure hold of holster with leg strap, optional hip strap and back with anti-slip coating
- Straps of the holster can be individually adjusted to leg length, thigh and hip circumference
- Fast removal using practical snap buckles



# SAFETY

<b>CENTERSTANDS</b>	<b>178</b>
<b>EXTENSIONS FOR SIDE STAND FOOT</b>	<b>180</b>
<b>ADJUSTABLE MIRRORS</b>	<b>182</b>
<b>MIRROR EXTENSIONS</b>	<b>184</b>
<b>EVO LIGHTS</b>	<b>186</b>
<b>ACCESSORIES</b>	<b>188</b>

# CENTERSTANDS

When it comes to new motorcycle models, we're usually the first accessory supplier to put high-quality centerstands models on the market. The lightweight steel-tube centerstands are designed to fit as closely as possible to the motorcycle to preserve ground clearance, all without sacrificing stability or convenience.

In most cases, you no longer need to buy a swingarm stand or spools. During long downtimes in the winter months, the centerstand helps take the load off your tires.

## INCLUDED IN DELIVERY

Centerstand, mounting material

Centerstands

starting at 160 €

Will it fit your motorcycle? Use the bike filter on [sw-motech.com](https://www.sw-motech.com)



## MATERIAL

- Made of robust steel
- Blasting the surface prior to powder coating improves corrosion resistance

## FUNCTION

- Ensures a secure stand on trips with lots of luggage and during maintenance
- Bike-specific design for easy mounting and high cornering clearance
- Easy to lift up the motorcycle
- Outrigger foot pedal for optimal leverage



Constructed to provide the greatest possible cornering clearance



A secure stand during maintenance



# EXTENSIONS FOR SIDE STAND FOOT

This durable foot extension has a large contact surface for enhanced stability, even on uneven ground and soft soil. Accuracy of fit and easy handling for everyday driving were both equally important during product development. The profiled topside of the foot extension makes it easy to fold out the stand - even with heavy boots.

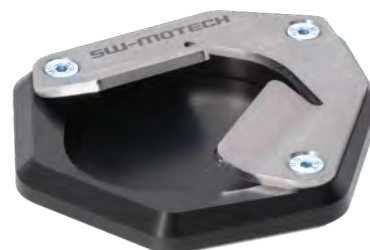

## INCLUDED IN DELIVERY

Extension for side stand foot, mounting material

Extensions for side stand foot

starting at 25 €

Will it fit your motorcycle? Use the bike filter on [sw-motech.com](https://www.sw-motech.com)

## MATERIAL

- High-quality workmanship: CNC milled
- Anodized aluminum alloy

## FUNCTION

- Doubles the foot's surface area (bike specific)
- Provides secure positioning on soft or uneven ground
- Bike-specific sandwich design provides strength and precision fit
- Mounts on original side stand



For a secure stand and greater contact surface on uneven ground

# MIRROR SET SPORT

SW-MOTECH manufactures the adjustable mirrors in a modern and flat design from high-quality black anodised aluminium. Two versions, one with a long and one with a short mirror arm, offer many adjustment options. The mirror arms consist of continuously adjustable elements and can each be extended by 30 millimetres. The various adjustment options of the mirrors give the pilot more safety through a better overview of his surroundings. In addition, the mirrors impress with their modern design made of milled and forged aluminium. They combine high functionality and precision with safety and a sporty look.

## INCLUDED IN DELIVERY

2 mirrors, mounting material

Mirror Set Sport short	250 €
Mirror Set Sport long	250 €
Will it fit your motorcycle? Use the bike filter on <a href="https://www.sw-motech.com">sw-motech.com</a>	



## MATERIAL

- Made from high quality and forged aluminium
- Partial areas and functional surfaces milled
- Black anodized
- Engraved SW-MOTECH logo
- Modern and flat edge design

## FUNCTION

- 4 different adjustment possibilities for best possible alignment
- Stepless rotation and inclination of the mirror arm
- Length of the mirror arm continuously adjustable in the range of 30 mm
- Ball head on mirror housing for optimum fine adjustment
- For the best possible view and precise alignment of the field of vision
- Mounting on existing mirror connection
- Mirrors have an ECE test mark



Length of the mirror arm continuously adjustable in the range of 30 mm



Engraved SW-MOTECH logo

# MIRROR EXTENSIONS

To ensure that your own shoulders aren't the only thing you see in the rear-view mirror, the extension elements provide a significantly improved field of vision by relocating the mirrors to the outside. Once adjusted and screwed on, the sturdy, well-designed extensions provide secure hold for the mirrors, even when riding off-road or at high speeds. The various mounting options for these mirror extensions match the appearance of any motorcycle - whether it's an enduro, naked bike or a fully-faired street bike.

## INCLUDED IN DELIVERY

2 mirror extensions, mounting material

Mirror extensions

starting at 50 €

Will it fit your motorcycle? Use the bike filter on [sw-motech.com](https://www.sw-motech.com)

## VERSIONS

### EXCLUSIVE FOR BMW

Mounts into existing mirror threads. Black powder coated steel. Up to 6.6cm lateral relocation. Unrestricted access to grip switches.



### FOR MIRRORS MOUNTED ON THE HANDLEBAR

Mounts into existing mirror threads. Black anodized aluminium. Up to 4 cm higher, up to 4 cm lateral shift.



### PROFILE EXTENSION

For fairing mirrors. Black milled polyamide. Lateral relocation of up to 4 cm.



# EVO LIGHTS

Increased safety on the road: The extra-wide beam of the EVO fog lights provide increased „see and be seen“ capabilities, especially in fog and bad weather. The powerful, more focused light of the EVO high beams provide excellent long-range illumination. This provides optimal lighting for the rider's view and ensures safety during on- or off-road riding.

## INCLUDED IN DELIVERY

2 EVO lights, cable harness with fuse, handlebar switch



 12 W/1,050 LM ECE R19 F3

EVO fog lights NSW.00.490.10001 325 €

EVO fog lights kits including light mounts starting at 345 €

Will it fit your motorcycle? Use the bike filter on [sw-motech.com](http://sw-motech.com)

 12 W/800 LM ECE R113 Rev.2

EVO high beam NSW.00.490.10101 325 €

Will it fit your motorcycle? Use the bike filter on [sw-motech.com](http://sw-motech.com)

## MATERIAL & FUNCTION EVO LIGHTS

- High-quality aluminum housing, black powder coated
- Water and dustproof (safety class: IP69)
- Voltage: 12V
- LED technology reduces electrical system load and reduces heat output, resulting in greater longevity
- Compact size with a diameter of 7.1 cm
- Lights have an ECE test mark

## FUNCTION EVO FOG LIGHTS

- Power: 12 W / luminous flux: 1,050 LM
- ECE test mark: ECE R19 F3
- Splash-proof and bright green handlebar switch for convenient operation
- Particularly wide light distribution

## FUNCTION EVO HIGH BEAMS

- Power: 12W / luminous flux: 800 LM
- ECE test mark: ECE R113 Rev.2
- Splash-protected, blue glowing handlebar switch for comfortable operation
- Highly concentrated beam with long-distance range

## REQUIRED FOR MOUNTING

Crash bar clamps or bike-specific light brackets.

> [more on page 188](#)

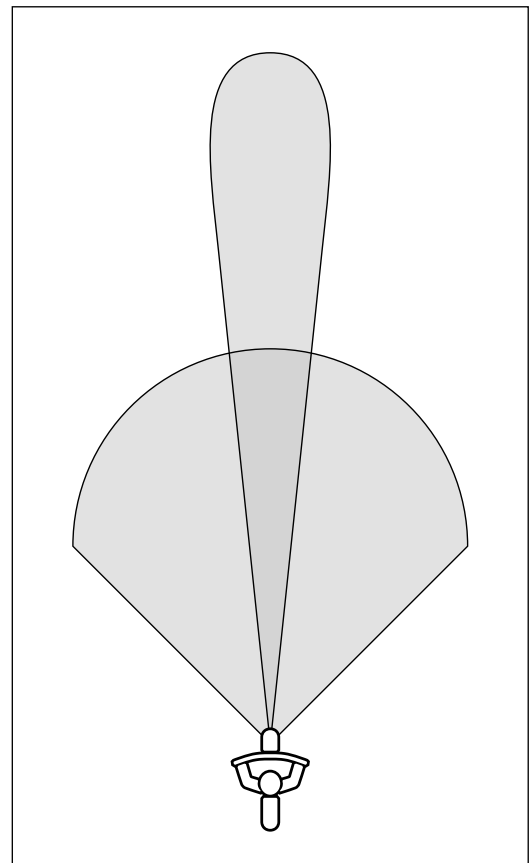

Comparison of light distribution of EVO fog lights and high beams

# ACCESSORIES

## EVO LIGHTS



### LIGHT MOUNTS

These bike specific mounts provide optimal positioning of the EVO lights, because they are developed exclusively for each motorcycle model.

The sturdy brackets are made of powder-coated steel and are screwed onto existing attachment points. They offer a secure hold for the EVO lights, even when riding off-road.

The lights can be mounted upright, hanging down or to the side, depending on the motorcycle model.

EVO fog light and high-beam light kits are available for many motorcycle models; these include the lights, cable harness and switches as well as the corresponding bike specific mounts.

Light mounts

starting at 20 €

### EVO FOG LIGHT SWITCH FOR COCKPIT

The splash-proof and illuminated on/off switch can be mounted on barrel handlebars with a diameter from 22 mm to 1 inch (25.4 mm). The connection is made via an insulated cable with three plug connections, cable length 30 cm, for 12 V motor vehicle operating voltage.

EMA.00.107.12900

20 €

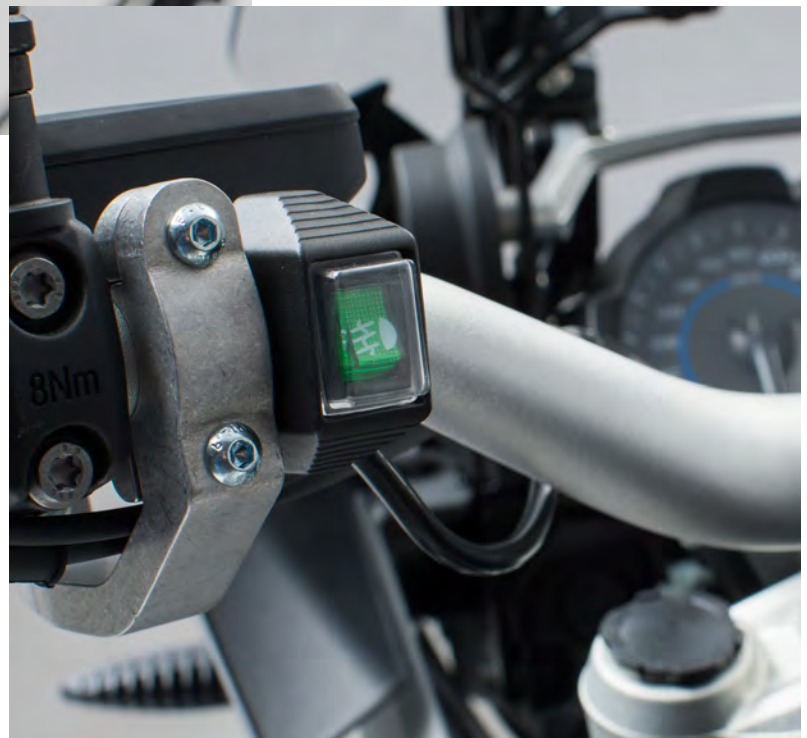

## EVO LIGHT GUARDS

The brushed stainless steel guard protects the housing of the EVO lights while giving your bike an adventurous look. It is attached directly to the lights with only two screws. Looks elegant thanks to the brushed stainless steel and laser-etched SW-MOTECH logo. Two guards as well as the mounting material are included in delivery.

NSW.00.490.10201	40 €
NSW.00.490.10500	40 €



## CRASH BAR CLAMP

With these clamps, EVO lights can be mounted to crash bars or other bike parts of the appropriate diameter. Includes rubber inserts for adapting to 22/25.4/27/27 mm and 28 mm. 2 crash bar clamps for lights, rubber inserts and mounting material are included in delivery.

NSW.00.004.13000/B	35 €
--------------------	------



# PROTECTION

<b>CRASH BARS</b>	<b>194</b>
<b>CRASH PADS</b>	<b>200</b>
<b>ENGINE GUARDS</b>	<b>204</b>
<b>HANDGUARDS &amp; LEVER GUARDS</b>	<b>210</b>



# OFF TO ADVENTURE

You climb onto your bike and ride out into the backcountry. You leave everyday life behind and lose yourself in unknown terrain off the beaten track. It's fun, but there's some respect there, too. Respect for the harm that may come to you or your beloved bike. Whether you're deep in the woods or on a well-traveled highway, the result is the same: no-one wants a break-down. And a damaged engine component or case can not only be expensive, it can leave you stranded. We develop our crash bars, engine guards and crash pads in our workshop in Rauschenberg to prevent that.

All protective parts are carefully adapted by hand to the machine's lines. We work both directly on the bike and with the help of computer-aided design programs.

Take a crash bar, for example: it should fit perfectly and also look good. Ideally, it makes your bike look even better. In addition to the perfect fit, we also make sure that the crash bar can be mounted easily. The challenge here is to achieve a large protection area with as few load-bearing attachment points as possible.

In addition, the dynamics of the machine during travel and in case of a fall must be considered.



Discover more on our  
youtube channel!



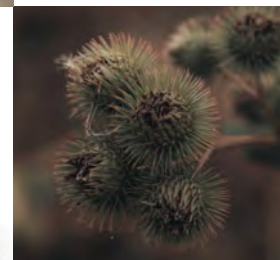

We design the crash bars in such a way that they offer sufficient cornering clearance and in case of a fall the vehicle rolls over the bar onto the handlebars without damaging the fairing or the engine area.

## IT'LL TAKE A BEATING.

Development is followed by production in our plant in the Czech Republic. Experienced metalworkers work here, who for twenty years have proven time and again what solid workmanship looks like. Thanks to modern CNC technologies, the welds and pipe bends in all our products are precise and solid, from the first part in the series, to the last.

The consistently high quality and reliability of the components are also guaranteed by the use of high-quality materials. SW-MOTECH works exclusively with high-quality steel and aluminum alloys. Additional powder coatings or brushing and polishing of the surfaces ensure the corrosion resistance of the protective parts.

For all major motorcycles, we offer a wide range of protection products suitable for the respective model and year of construction. In addition, SW-MOTECH offers a whole package of protection components for the current range of adventure and dual-sport motorcycles: the adventure sets contain crash bars, engine guard, crash pads and handguards.

With SW-MOTECH protection components installed on your bike, the protection of your machine is a given. Now you can focus on the important things, such as getting out on your next adventure!



# CRASH BARS

Whether your bike is a naked sportbike or an adventure touring machine, crash bars from SW-MOTECH provide the necessary extra safety for tank, fairing and other attachments. The elements manufactured specifically for the motorcycle model fit seamlessly into the appearance of the vehicle and at the same time offer optimum cornering clearance. Tailored add-on elements make it possible to attach things easily and reliably to original mounting points. Depending on the motorcycle model the crash bars are available in various design, material and color variations.

## INCLUDED IN DELIVERY

2 crash bars, mounting material

Crash bar

starting at 120 €

Adventure set protection

starting at 360 €

Will it fit your motorcycle? Use the bike filter on [sw-motech.com](https://www.sw-motech.com)

## MATERIAL

- Robust steel construction
- Weather and corrosion-resistant powder coating

## FUNCTION

- Reliable protection for important components
- Highly stable construction
- Model-specific development guarantees precise fit and reliable frame linkage
- Optimized lean angle guaranteed



[Discover more on our youtube channel!](#)



## PRO TIP:

For dual-sport and adventure bikes, we offer an attractively priced all-round carefree package with protectors for the most important components.

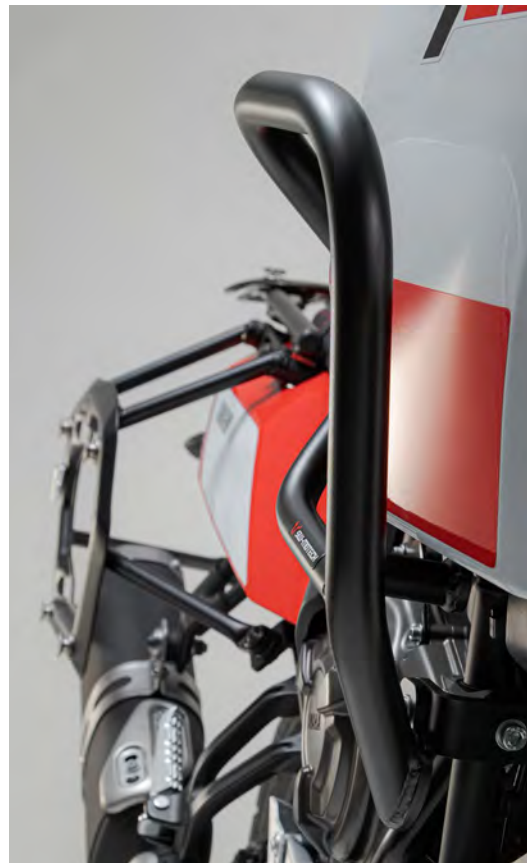

Precision production for the motorcycle.

# UPPER CRASH BARS

The upper crash bars primarily protect the motorcycle's fairing. Depending on the motorcycle model, they are made of powder-coated steel or stainless steel and are mounted as an addition to the SW-MOTECH crash bar or the original crash bar.

## INCLUDED IN DELIVERY

2 upper crash bars, mounting instructions, mounting material

Upper crash bar

starting at 190 €

Will it fit your motorcycle? Use the bike filter on [sw-motech.com](https://www.sw-motech.com)

## MATERIAL

- Robust steel construction
- Weather and corrosion-resistant powder coating

## FUNCTION

- Fairing protection
- Bike-specific development guarantees a snug fit
- Simple, screw-on mounting on original attachment points



## REQUIRED FOR MOUNTING:

Depending on the specific model, installation is only possible with SW-MOTECH crash bars or with the original crash bars of the manufacturer.

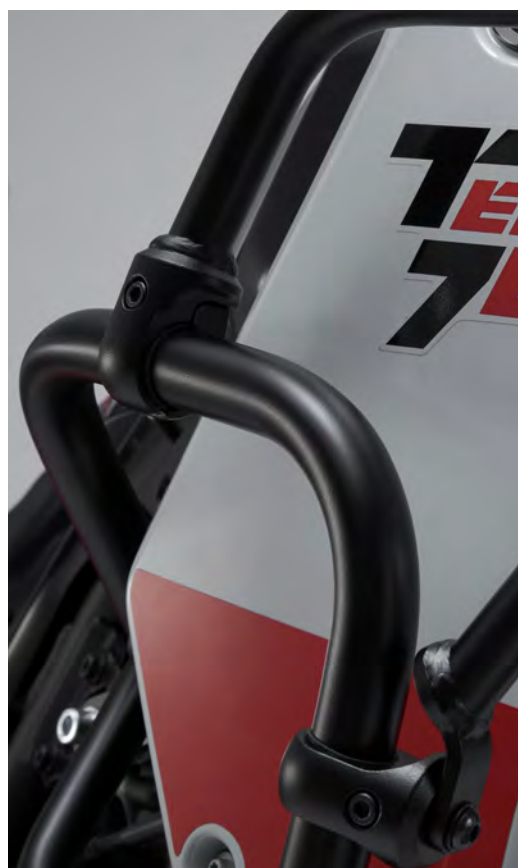

Fitted crash bar clamps for a secure hold.



# VARIOUS TYPES OF CRASH BARS

We always manufacture our crash bars to fit the respective motorcycle model. In doing so, we pay attention to both the best possible protection and optimum cornering clearance as well as a beautiful line. Our range includes over 180 models for naked bikes, enduros, cruisers and café racers.

In addition to the different shapes, SW-MOTECH uses different materials. Crash bar models for KTM motorcycles we offer in the well-known KTM orange and for popular bikes like the big GS 1250 there are models with black powder coating or made of stainless steel.

You can find the right crash bar for your bike by using the bike filter on our website. If you want to learn more about our crash bars, check out our videos. You can find the link here at the bottom of the page.



[Discover more on our youtube channel!](#)



Left: Robust and discreet at the same time - Our crash bars for naked bikes

Below: Crash bars in special colours like KTM Orange

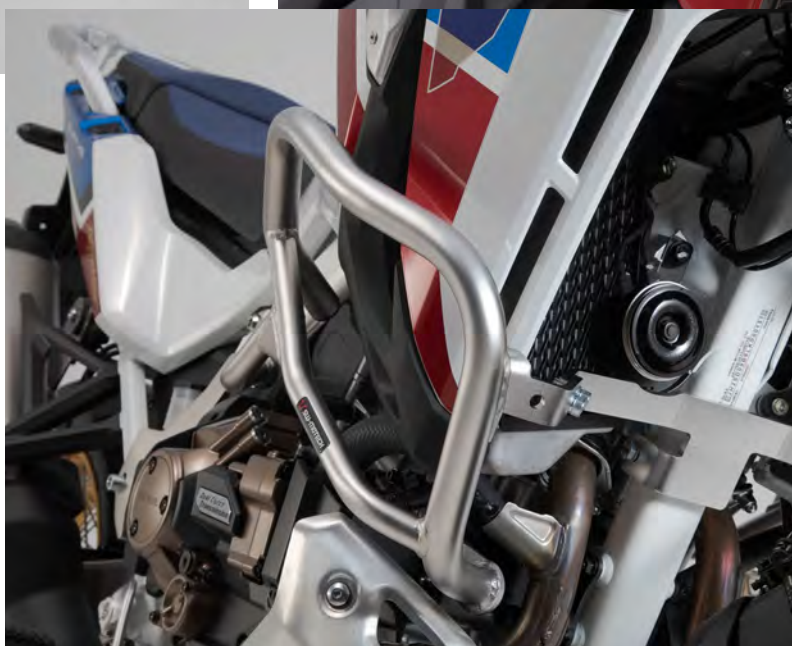

Above: Stainless steel crash bar on the Africa Twin

Right: Protection for the fairing by robust bars made of black powder coated steel



# FRAME SLIDERS

Additional protection in case of a fall is provided by the slider set for attaching to the frame. The shape, surface and material of the pads provide excellent sliding properties to reduce damage to the motorcycle. And if necessary, CNC-milled slider pads made from abrasion-resistant polyamide can be quickly exchanged.

## INCLUDED IN DELIVERY

Crash pads, mounting material



Frame Sliders

starting at 115 €

Will it fit your motorcycle? Use the bike filter on [sw-motech.com](https://www.sw-motech.com)

## PRO TIP:

In combination with the matching axle sliders, the frame sliders are a discreet solution for protecting sportbikes.

## MATERIAL

- Well-shaped, exchangeable (if needed) slider pad made of abrasion-resistant polyamide
- Extremely solid, CNC-milled substructure made of aluminum alloy

## FUNCTION

- Good sliding properties and emergency operating features
- Large contact surface for best-possible force distribution, protection of frame, engine and fairing
- Easy mounting and sturdy frame attachment thanks to bike-specific add-on elements



Good protection and design that fits the bike

# AXLE SLIDERS

The redesigned crash pads for the front and rear axle, made of abrasion-resistant plastic, protect the drive shaft and swing arm from damage in the event of a crash. The plastic core is now even more resistant with 30% glass fiber content. In combination with the TPE sheathing, the crash pads provide additional cushioning in case of unintentional contact with the road. The polished, red bull logo serves as a visual highlight on the motorcycle, and the axles made of high-quality steel with zinc-nickel coating guarantee long durability.

## INCLUDED IN DELIVERY

Crash pad/s, mounting material

Slider set for front axle	starting at 50 €
Slider set for rear axle	starting at 45 €
Will it fit your motorcycle? Use the bike filter on <a href="https://www.sw-motech.com">sw-motech.com</a>	



## PRO TIP:

The bike-specific protectors are available individually or in a set of two for the front and rear axles depending on the motorcycle model.

## MATERIAL

- Robust core of fiberglass-enforced plastic (PA6 GF30) for high mechanical dampening capacity
- Matte black surface with polished bull logo in red
- Axles made of high-quality steel with zinc-nickel coating

## FUNCTION

- Good sliding properties and emergency operating features
- Protects drive shaft and the swing arm
- Large contact surface for best possible force distribution
- Simple mounting on the front and rear axles



Axles with corrosion-resistant coating are included in the delivery



Fiberglass-enforced plastic with TPE sheathing for high mechanical dampening capacity

# ENGINE GUARDS

Additional protection against rocks and contact with obstacles for the engine: the high-quality, aluminium alloy engine guard shows what it's capable of off the street, but provides extra safety and an individualized look on the streets, too. State-of-the-art production gives these bike-specific protectors a secure fit without affecting ground clearance. The installation on frame mounting points lends additional stability and allows for easy installation.

## INCLUDED IN DELIVERY

Engine guard, mounting material

Engine guard

starting at 100 €

Adventure set protection

starting at 360 €

Will it fit your motorcycle? Use the bike filter on [sw-motech.com](https://www.sw-motech.com)

## MATERIAL & FUNCTION

- Durable design made of high quality aluminum alloy
- Underbody protection from rock chips and collision
- Bike specific development for perfect fit
- Reliable and easy installation on original attachment points, modifications to the motorcycle are not required

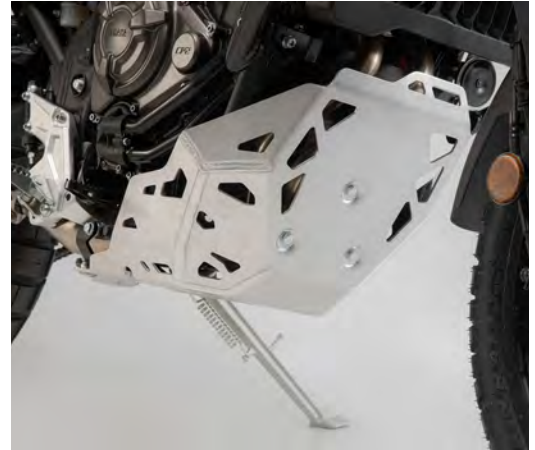

## PRO TIP:

Adventure set protection: for dual-sport and adventure bikes, we offer an all-round carefree package with protectors for the most important components at an attractive price.

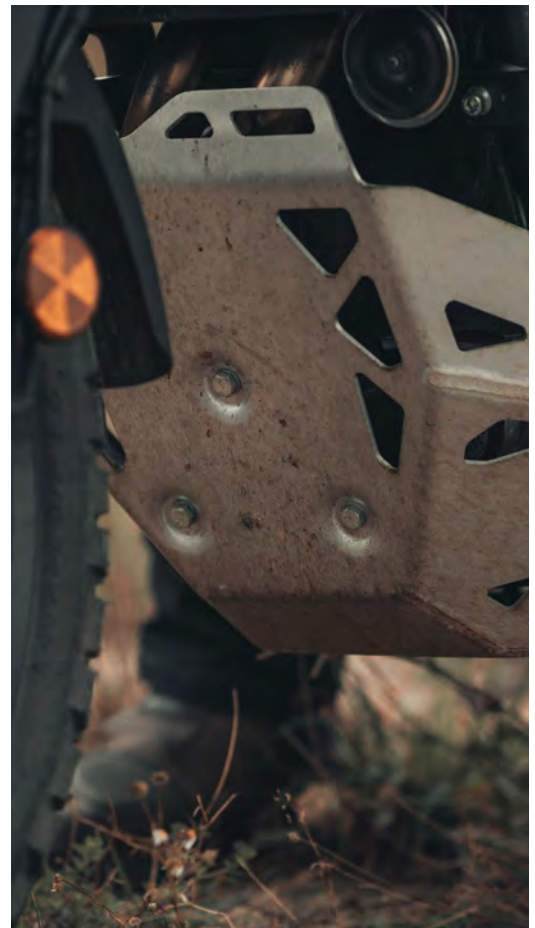





Depending on the motorcycle model, we adapt the engine guard to the shape of the vehicle - for the best possible protection and the greatest possible cornering clearance



Above: Discreet engine guard for the BMW R nineT

Right: Engine guard in two different colors - brushed aluminum and powder coated black



# INDIVIDUALLY DESIGNED FOR YOUR BIKE

## BUILT FOR YOUR NEXT ADVENTURE

Not all engine guards are the same. Just like every motorcycle has its own design, the engine guard has to be developed individually. Since the beginning twenty years ago, when we built the first engine guards for our own motorcycles, we adapt the robust aluminum sheets as exactly as possible to the shape of the respective engine.

That's how we can offer you the right engine guard for over 190 different motorcycle models. Once the protective part is installed, you can relax and go for a ride. The mostly 4 millimeters thick aluminum sheet and the robust screw connections can withstand many impacts and unwanted encounters with stone and wood. So your bike stays intact and you get safely to your destination.

For large enduros there are also extensions for the engine guard for centerstand. We equip smaller naked bikes with matching front spoilers - they look sporty and can also protect the manifold and other engine parts from damage.

**WILL IT FIT YOUR MOTORCYCLE? USE THE BIKE FILTER ON SW-MOTECH.COM**



Water pump protection on the Ténéré 700 (left) and brake reservoir guard on the Africa Twin CRF 1100 (below)



Brake cylinder guard on the Ténéré 700 (right) and heel guard and chain guard on the Tiger 900 (below)





# PROTECTION FOR EVERY DETAIL

Many components vital to the engine's survival are often unprotected. In the event of a crash, damage can occur with serious consequences: Water pump, brake fluid reservoir, brake pumps, alternator cover and the boxer's cylinder all want to reach their destination undamaged.

Damage to clothing and footwear as well as injuries caused by hot exhaust pipes and the drive chain can also be prevented by our protective components. For this we build small and shapely protection parts made of aluminum, mostly milled and anodized, which you can find suitable for your bike in our online store.

# KOBRA HANDGUARDS

The KOBRA handguards' sturdy aluminum frame protects the rider in case of accidents and falls and the exchangeable handguard shells made of impact-resistant Moplen plastic offer additional protection against weather, stone chips and light brush.

## INCLUDED IN DELIVERY

2 KOBRA handguards, mounting material



KOBRA handguard kit

starting at 150 €

Will it fit your motorcycle? Use the bike filter on [sw-motech.com](https://www.sw-motech.com)

## TIP:

Please specify the bike model in the bike filter in the online store when selecting the protectors. For most bikes we offer the protectors with two-point mounting. For some models only protectors with one-point-mounting are awarded.

## MATERIAL & FUNCTION

- Handguard shells made from impact-resistant Moplen plastic
- Easy installation of the handguard shells on the aluminum bars
- Aluminum bar with bike-specific mounting kit for particularly robust two-point mounting
- Also available as a single-point mounting version depending on the model
- Modern design fits seamlessly into the look of the motorcycle



Single-point mounting



Two-point mounting



## LED INDICATOR SET

LED indicators, available separately, offer increased visibility in traffic and can be easily placed in the recesses of the handguards. A resistor set is required for retrofitting the 10 or 20 watt blinkers to 1 watt KOBRA LED

LED indicator set for KOBRA handguards	HPR.00.220.30000/B	50 €
Resistor set for LED indicators	HPR.00.220.30700/B	15 €

Will it fit your motorcycle? Use the bike filter on [sw-motech.com](https://www.sw-motech.com)



## EXTENSION SET FOR KOBRA HANDGUARDS

The protective surface of the KOBRA handguards can be increased if necessary by an expansion made from impact-resistant plastic. The expansion is screwed onto the top edge of the KOBRA handguards. It fits seamlessly into the look of the bike, but still offers the hands considerably more protection from wind and weather, as the protective surface can be increased by 50%.

HPR.00.220.30100/B	20 €
--------------------	------

# LEVER GUARDS

The beautiful lever guards made from black anodized aluminum offer additional protection for brake and clutch levers. The high-quality forged components are available as a pair or inset with the impact-resistant wind protection. Thanks to the high-quality workmanship, they provide a stylish element on the handlebar and also protect during falls and accidents.

## INCLUDED IN DELIVERY

2 lever guards, mounting material

Lever guards	135 €
Lever guards with wind protection	160 €
<b>Will it fit your motorcycle? Use the bike filter on <a href="https://www.sw-motech.com">sw-motech.com</a></b>	

## MATERIAL & FUNCTION

- Lever guards made from black anodized aluminum
- To be attached to the end of the handlebar
- Protection for brake lever and clutch lever
- Additional protection against falls and accidents



### PRO TIP:

In combination with the wind protection, the lever guards offer additional protection from wind.



Protection for brake lever and clutch lever



Lever guards with wind protection for improved protection.

<b>BARKBUSTERS HANDGUARDS</b>			
STORM handguards	Large wraparound guard.	STM-003-00-BK	40 €
JET handguards	Ideal for bikes with long levers.		30 €
VPS handguards	Plastic guard with variable height wind deflector. Ideal for bikes with		35 €
Carbon fiber handguards	Low weight handguard with unique style. Not compatible with EGO frames.	BCF-003-01-CF	180 €
Mounting kits	Including aluminum frame and mounting material. Universal or bike-specific.		starting at 85 €
Handguard kits	Including handguards, aluminum frames and mounting material.		starting at 100 €
<b>BARKBUSTERS ACCESSORIES</b>			
BBZ handguard kit	Sturdy fabric weather protection.	BBZ-001-01-BK	100 €
Bar end weight	Steel. Two-piece set.	B-066	45€
Skid plate	For VPS and JET. Two-piece set.	VPS-002-00-BK	16 €
Bar end plug	Available in different colours. Two-piece set.		16 €
LED indicator light	Yellow. Fits JET, VPS and STORM. Two-piece set. ECE test mark.	LED-001-02-AM	60 €
LED position light	White. Fits JET, VPS and STORM. Two-piece set. ECE test mark.	LED-002-02-WH	60 €





# ERGONOMICS

<b>EXTENSION FOR BRAKE PEDAL</b>	<b>218</b>
<b>FOOTRESTS</b>	<b>220</b>
<b>GEAR LEVER</b>	<b>224</b>
<b>BAR RISERS</b>	<b>226</b>
<b>SEAT MODIFICATIONS</b>	<b>230</b>
<b>CUSHION</b>	<b>232</b>

# EXTENSION FOR BRAKE PEDAL

The extension for brake pedal is ideal for off-road riding, because even when standing, it allows for a more well-controlled application of brakes. It complements the original brake lever appearance and allows both a widening and an increase of the overall contact surface area. This translates to better control and increased safety.

## INCLUDED IN DELIVERY

Extension for brake pedal, mounting material



Extension for brake pedal

90 €

Will it suit your motorcycle? Use the bike filter on [sw-motech.com](https://www.sw-motech.com)

## MATERIAL & FUNCTION

- To supplement the original brake lever appearance
- Raised and wider surface
- Improved grip thanks to ridged surface – even when wet and dirty
- Simple mounting with just two screws on to original brake pedal



Two height settings for contact surface



Widening of the contact surface of the foot

# EVO FOOTPEGS

Is your original footrest impossible to position comfortably? If so, then the new EVO footrest from SW-Motech is the perfect solution. This sophisticated system, consisting of rotating elements with firmly interlocking teeth, gives you 36 options for positioning. The position of the footrest can be adjusted downward, forward and back and its angle is also fully adjustable so as to suit your individual needs.

## INCLUDED IN DELIVERY

2 EVO footrests, 2 joint adapters, mounting material

EVO footrest kit	140 €
Will it suit your motorcycle? Use the bike filter on <a href="http://sw-motech.com">sw-motech.com</a>	

## MATERIAL &

- Made from electropolished, corrosion-resistant cast stainless steel
- Removable, metal-reinforced rubber top surface with anti-slip texture and large contact surface (approx. 8 x 5 cm/3.15 x 2 in) for extra comfort and grip

## FUNCTION

- 36 adjustment options: downward, forward, and back, as well as angle adjustment thanks to the rotating interlocking elements
- A firm hold, thanks to the interlocking, bolted elements
- Markings make it easier to adjust both sides symmetrically
- Profile with rounded edges protects boot soles and provides extra grip at the same time
- Easy mounting on original footrest mount
- Individual height adjustment (highest setting corresponds to the original position, lowering up to max. 15 mm possible)



[Discover more on our youtube channel!](#)



The individual components of the EVO footrest



The EVO footrest without rubber overlay

# ION FOOTRESTS

Our reasonably priced ION footrest kits allow the footrest to be mounted at its original height or lowered by 15 mm. Extremely durable and built to last, these stainless-steel footrests provide plenty of extra grip and are recommended for adventure, offroad and urban motorcycles.

Hinges made from high-strength aluminum alloy ensure that the footrest can fold out of the way if the bike tips over. A removable rubber overlay reduces vibrations and the tread offers good grip even in offroad use.



## INCLUDED IN DELIVERY

2 ION footrests, 2 joints, mounting material

ION footrest kit	110 €
Will it suit your motorcycle? Use the bike filter on <a href="http://sw-motech.com">sw-motech.com</a>	

## MATERIAL & FUNCTION

- Made of corrosion-resistant cast stainless steel with removable rubber pad
- Profiled, anti-slip surface texture
- Easy mounting on original footrest mount
- Install the footrest at original height or 15 mm lower
- Large contact surface



The ION footrest with and without rubber overlay



The ION footrest mounted

# GEAR LEVER

Gear levers by SW-MOTECH combine specially selected materials and innovative design with perfect fit.

Our high-quality, aluminum alloy milled gear levers can be adjusted either freely or at preset lengths depending on your bike model to provide the perfect shifting position.

## INCLUDED IN DELIVERY

Gear lever, mounting hardware



Gear lever		starting at 140 €
Extension for gear lever	FSC.00.127.10000/S	13 €
Will it suit your motorcycle? Use the bike filter on <a href="http://sw-motech.com">sw-motech.com</a>		

## MATERIAL & FUNCTION

- CNC-milled aluminum coated with HART-COAT®
- Gearshift holder is either freely adjustable or can be adjusted in intervals of 1, 2 or 3 centimeters (also beyond the original position)
- Spring mechanism allows the gear lever to fold in and protects against breakage in case of a fall



Laser engraved SW-MOTECH logo



Gear lever extension

# VARIABLE BAR BACKS

The variable bar back allows you to adjust your handlebars. This allows you to bring the handlebar closer to your needs for a more comfortable and upright seating position. You can choose between seven different positions at intervals of 5 millimeters. We offer the variable bar backs of milled and anodized aluminum for handlebars with the following diameters: 22, 28 and 32 millimeters.

Color-wise you have the choice between black, silver and anthracite. A bull logo on the front and a SW-MOTECH lettering - both engraved - make the bar back to a small and fine accessory for your bike.



## INCLUDED IN DELIVERY

2 variable bar backs, mounting hardware

Variable bar back for Ø22 handlebar. Silver.	LEH.00.039.30000/S	170 €
Variable bar back for Ø22 handlebar. Silver.	LEH.00.039.30000/B	170 €
Variable bar back for Ø22 handlebar. Silver.	LEH.00.039.30000/A	170 €
Variable bar back for Ø28 handlebar. Black.	LEH.00.039.31000/S	170 €
Variable bar back for Ø28 handlebar. Black.	LEH.00.039.31000/B	170 €
Variable bar back for Ø28 handlebar. Black.	LEH.00.039.31000/A	170 €
Variable bar back for Ø32 handlebar. Anthracite.	LEH.00.039.32000/S	170 €
Variable bar back for Ø32 handlebar. Anthracite.	LEH.00.039.32000/B	170 €
Variable bar back for Ø32 handlebar. Anthracite.	LEH.00.039.32000/A	170 €

Will it suit your motorcycle? Use the bike filter on [sw-motech.com](http://sw-motech.com)

## MATERIAL

- CNC-milled from high-strength aluminum alloy
- Corrosion protection through anodization
- Available in black, silver or anthracite
- With engraved logo and SW-MOTECH lettering

## FUNCTION

- Handlebars can be moved in seven positions, each 5 millimeters apart
- Available for vehicles with handlebars with 22, 28 or 32 millimeters diameter
- Increase by 25 mm / 28 mm
- For a more relaxed seating position



Variable in seven different positions



Engraved logo



# BAR RISERS IN MANY VARIATIONS

If you can't reach the handlebars comfortably, SW-MOTECH offers you the choice between universal handlebar risers in various designs, bike-specific variants or handlebar relocators that offer a relocation to the rear in addition to raising the handlebars.

Maximum flexibility is offered by our variable handlebar risers with seven different positions as well as the Vario handlebar relocations, which allow stepless adjustment to the front, rear and height. For those who want to replace their 22 mm handlebars with 28 mm handlebars, we offer converters to replace the original.

We manufacture, depending on the model, the components of high quality aluminum alloy - cast or milled and in different colors: black powder coated or anodized in silver, black and anthracite.



Discover more:  
[sw-motech.com](http://sw-motech.com)



Handlebar relocations offer both: an increase of 30 mm and a relocation of 21 or 22 mm closer to the rider



Sit more upright and ride more relaxed: Handlebar risers offer you up to 50 mm higher grip position



The handlebar with 28 mm diameter should be on a 22 mm mount? No problem with our converters!





# NAVIGATION

<b>T-LOCK</b>	<b>238</b>
<b>NAVI- &amp; SMARTPHONE-CASE</b>	<b>240</b>
<b>UNIVERSAL KITS</b>	<b>242</b>
<b>GPS HOLDERS</b>	<b>244</b>



# NAVIGATION WITH T-LOCK

The T-Lock holder has an important function in the SW-MOTECH world: it's now also a fastener for navigation accessories. Up to now, it has mainly been used in the field of soft luggage. The adapter function has undoubtedly proven itself and motivated us to take it one step further. The universal quick connector opens up numerous fastening possibilities and even more flexibility - especially when it comes to navigation.

## ONE T-LOCK - MANY DEVICES

Various GPS devices or smartphones can be quickly and safely attached to the handlebars using a variety of accessory bags, such as the GPS case, Phone Case or Smartphone Drybag. The underside of these accessory bags have the corresponding counterpart for the T-Lock holder. By means of the ball-and-socket joint, the T-Lock holder can be secured to a compatible socket arm and individually aligned on motorcycle's handlebar. The universal Navi kits available in our online store allow you to find a mounting solution for many bikes.





#### **FITS TO YOUR COCKPIT**

Every cockpit, every handlebar is different - the individual needs of riders in any case. The exact positioning and easy attachment of GPS solutions and smartphones are even more important. Thanks to using the T-Lock holder as a universal quick connector, we've added even more flexibility - attach it how and where you like it. And that in the twinkling of an eye.

#### **MOLLE MAKES IT FLEXIBLE**

This flexibility also works when it comes to luggage: once mounted on the MOLLE attachment of tail bags or accessory bags, it serves as a practical attachment point for additional bags. A quarter turn is all it takes to fasten and unfasten, and with the T-Lock, small-scale looping and positioning is a thing of the past. To attach, turn the T-Lock a quarter-turn clockwise. A quarter-turn counter-clockwise is enough to loosen it again.



# T-LOCK HOLDER

Want to attach an accessory bag to the MOLLE system quickly and easily? Just put on the T-Lock, turn 90 degrees clockwise and the case is fixed.

Via a twist lock, the T-Lock holder with MOLLE adapter connects small accessory bags such as the PRO Pocket with tail bags and tank bags that are fitted with a MOLLE system. The MOLLE attachment system is used for all PRO series' tank bags and tail bags, as well as for numerous bags from the Legend Gear series. The T-Lock consists of two parts: The lower part of the T-Lock on your bag's MOLLE attachment is secured by means of a star-shaped adapter. The top is looped once on your accessory bag. After that, you can secure the T-Lock with a swift hand movement.

## INCLUDED IN DELIVERY

1 T-Lock holder

T-Lock holder	TL.00.940.10000	20 €
---------------	-----------------	------



## MATERIAL & FUNCTION

- Solid and durable plastic construction
- Simple attachment via twistlock
- Designed for universal use with the MOLLE system



The T-Lock holder can be secured to a suitable clamping arm and individually aligned on the handlebars of the motorcycle



The T-Lock holder connects accessory bags with the MOLLE system by means of a twist lock

# T-LOCK HOLDER FOR SMARTPHONE

With this holder, various smartphones can be quickly and securely attached to the handlebars of your motorcycle. The smartphone mount is placed on the matching T-Lock holder and secured with a quarter turn clockwise. The silicone straps allow you to flexibly and securely attach devices of different sizes. Various mounting options and universal Navi kits from our online store can be attached to the motorcycle.

## INCLUDED IN DELIVERY

T-Lock holder for smartphone



T-Lock holder for smartphone small	TL.00.940.10100	20 €
T-Lock holder for smartphone large	TL.00.940.10300	20 €

## MATERIAL & FUNCTION

- For quick attachment of smartphones
- Smartphone holder with silicone straps
- Model for small smartphones: For devices with maximum outer dimensions of 150 x 75 x 10 mm and minimum outer dimensions of 130 x 70 x 6 mm
- Model for large smartphones: For devices with maximum outer dimensions of 165 x 80 x 12 mm and minimum outer dimensions of 144 x 71 x 7 mm
- At least two of the three minimum external dimensions must be adhered to for the smartphone to stay in place



Smartphone mount with silicone straps



Universal Navi kit with T-Lock holder for smartphone

# NAVI CASE & PHONE CASE

The Phone Case impresses with practical features and allows you to use your portrait format smartphone as a GPS device. The Navi Case is designed for landscape format GPS devices.

The cover membrane makes it easy to use touchscreen surfaces. Velcro straps hold the hardware in place and the circumferential zipper makes it easy to open. The rubber lining keeps out moisture. With the T-Lock mount on the back, you can quickly and easily attach the case to the appropriate holder. The case is attached to the holder with a simple quarter turn clockwise.

## INCLUDED IN DELIVERY

1 Phone Case or 1 Navi Case

Phone Case	BC.GPS.00.010.10000	20 €
Navi Case	BC.GPS.00.011.10000	20 €



## MATERIAL & FUNCTION

- Phone Case: for devices in portrait format
- Navi Case: for devices in landscape format
- You can find which one suits your device in our online store
- Made of dimensionally stable EVA material
- With T-Lock holder on the back
- Touchscreen-friendly window
- Durable case with reinforced base plate
- Removable inner padding
- Foam rubber inserts and Velcro strips for positioning the device
- Cable feed



Durable shell with reinforced base plate



Phone Case: for devices in portrait format with a touchscreen window

# UNIVERSAL KITS

For conveniently mounting electronic devices like smartphones, GPS devices or GoPros in the cockpit, we offer a range of clever solutions. Our universal kit offers a variety of different attachment options: the provided 1" ball can be mounted on a M6 or M8 thread, on a mirror thread holder or with a mounting clamp. The mounting clamp is designed for handlebars with a diameter of 22.28 mm or 1 in. A pivoted socket arm makes positioning in the cockpit easy - so the display always remains in plain sight, without obstructing instrument view. The T-Lock holder on the clamp arm allows for quick attachment of the Navi Case and Phone Case.

## INCLUDED IN DELIVERY

1 mounting clamp, 1 ball with M8 thread and M6 converter, 1 holder for mounting on mirror thread, 1 2" clamp arm, 1 T-Lock holder, 1 ball joint with mounting plate, depending on the kit additionally a Navi Case / Phone Case or a RAM X-Grip clamp, mounting material



## UNIVERSAL KITS

Universal GPS mount kit with T-Lock	GPS.00.308.35000	50 €
Universal GPS mount kit with Phone Case	GPS.00.308.35100	60 €
Universal GPS mount kit with Navi Case	GPS.00.308.35200	60 €
GPS mount kit with ball clamp and T-Lock	GPS.00.308.35400	50 €
Universal GPS mount kit with Smartphone Drybag	GPS.00.308.35500	60 €
Universal X-Grip-Kit for large Smartphones	GPS.00.308.30500/B	90 €
Universal GoPro camera kit	CPA.00.424.12501/B	50 €

Will it suit your motorcycle? Use the bike filter on [sw-motech.com](http://sw-motech.com)

## MATERIAL & FUNCTION

- Complete set for mounting GPS devices, smartphones or GoPro cameras
- Balls and 2" socket allow for individual positioning
- T-Lock holder for quick mounting of Navi Case / Phone Case Pro
- 1" ball can be mounted on a M6 or M8 thread, on the mirror thread holder or with a mounting clamp
- Mounting clamp for handlebars with a diameter of 22.28 mm or 1"
- Hole pattern for GPS mount is compatible with hardcases and Navi Case Pro from SW-MOTECH and common GPS devices

### TIP:

The T-Lock receptacle on the back of the Navi Case / Phone Case allows for quick attachment to the Universal Navi Kit. A quarter turn clockwise fixes the Navi Case / Phone Case to the clamp arm.



1" ball for M6 or M8 thread



Swiveling clamp arm on the 1" ball holder



**UNIVERSAL GPS KIT WITH PHONE CASE**

This all-round carefree package includes a weatherproof Phone Case, which is attached to the T-Lock. Our universal kit offers a variety of different attachment options: the provided 1" ball can be mounted on a M6 or M8 thread, on a mirror thread holder or with a mounting clamp.

**UNIVERSAL NAVI KIT WITH T-LOCK HOLDER FOR SMARTPHONE**

The T-Lock holder with smartphone mount is included in delivery and allows you to quickly attach smartphones to the Universal Navi kit. The smartphone can be fixed to the socket arm with a simple quarter-turn clockwise. The silicone straps on the smartphone mount are used to attach devices of different sizes. A pivoted socket arm facilitates positioning in the cockpit - thus ensuring the display is always in view.



**UNIVERSAL X-GRIP KIT**

This versatile kit can be used to securely attach a large smartphone to almost any motorcycle. The X-Grip clamp impresses with its versatility - it gives smartphones a secure hold and can be flexibly aligned on a socket arm with the 1" adapter ball.



# MODEL-SPECIFIC GPS HOLDER

Our vehicle-specific GPS mounts combine clever positioning, vibration damping and easy removal. In order to provide the best possible view of your instruments and GPS, the GPS mount is attached to the handlebar mount, to struts or to another position in the cockpit, depending on the motorcycle model. The swiveling mount can be removed in one easy step and, thanks to its universal hole pattern, gives many current GPS devices as secure a hold as our Phone / Navi Case and Navi Case Pro device cases



## INCLUDED IN DELIVERY

1 model-specific GPS mount, mounting material

Model-specific GPS mount/holder

starting at 30 €

Will it suit your motorcycle? Use the bike filter on [sw-motech.com](http://sw-motech.com)

## MATERIAL

- GPS mount made of black powder-coated steel with locking mechanism made of fiberglass-reinforced plastic

## FUNCTION

- Removable and vibration-damping
- Easy mounting on existing mounting points in the cockpit, on the handlebar mounting bolts, the handlebar center brace or other tubes with a diameter of Ø 10/12 mm
- Pivotable for ideal view of devices
- Retaining plate with universal hole pattern gives the usual GPS models and Phone / Navi Case and Navi Case Pro device cases or hard cases from SW-MOTECH a secure hold
- Made to fit each bike model for optimal positioning

## MODEL-SPECIFIC MOUNTING



### GPS MOUNT ON THE HANDLEBAR

In this version, the holder is mounted on the bar mount. The removable GPS mount is pivotable and gives the rider the best view of their GPS device.



### GPS MOUNT FOR COCKPIT

To achieve optimal positioning, a powder-coated steel plate securely attaches the GPS mount to original connection points in the cockpit.



### GPS MOUNT ON TUBE Ø 10/12, 13/16, 17 MM

Crossbars, windshield mounts or other bars in the cockpit can provide the ideal connection point for mounting your GPS device, depending on your bike model. For these models, the removable GPS mount with clamp is available for tubes Ø 10/12 mm, 13/16 mm and 17 mm in diameter.

# INDEX

<b>INTRO</b>	<b>8</b>				
THE PEOPLE BEHIND THE BRAND	8				
THE NEW PACKAGING CONCEPT	14				
EVENTS	22				
WHAT DOES PREMIUM ACTUALLY MEAN?	28				
NEW PRODUCTS 2022	32				
THE RIGHT EQUIPMENT FOR YOUR BIKE	34				
<b>LUGGAGE</b>	<b>40</b>				
<b>TANK BAGS</b>	<b>43</b>				
TANK BAGS					
OVERVIEW	46				
PRO TANK BAGS	48				
PRO MICRO	48				
PRO DAYPACK	49				
PRO ENGAGE	50				
PRO CITY	51				
PRO SPORT	52				
PRO TRIAL	53				
PRO GS	54				
PRO ENDURO	55				
WATERPROOF TANK BAGS	56				
PRO YUKON WP	58				
PRO CITY WP	59				
PRO ENDURO WP	60				
PRO CROSS WP	61				
PRO TANK RING	62				
PRO TANK BAG ACCESSORIES	64				
LEGEND GEAR TANK BAGS	66				
MAGNETIC TANK BAG LT1	66				
STRAP TANK BAG LT2	67				
ION TANK BAGS	68				
ION ONE	68				
ION TWO	69				
ION THREE	70				
ION TANK RING	71				
<b>SADDLEBAGS /</b>					
<b>SIDE BAGS</b>	<b>72</b>				
SYSBAG WP	76				
SYSBAG WP L	76				
SYSBAG WP M	79				
SYSBAG WP S	80				
BLAZE SADDLEBAGS	82				
PRO BLAZE SADDLEBAGS	84				
SIDE BAGS LH	86				
SIDE BAG SYSTEM LH	87				
ASYMMETRICAL	87				
SIDE BAG SYSTEM LH	88				
SYMMETRIC	88				
LEGEND GEAR SIDE- & SADDLEBAGS	90				
SIDE BAG LC1/LC2	91				
LC SIDE BAG SYSTEM	92				
<b>TAIL BAGS</b>					
PRO TAIL BAGS					
PRO ROADPACK					
PRO REARBAG					
PRO RACKPACK					
PRO CARGOBAG					
PRO TRAVELBAG					
PRO SEAT RING					
PRO TAIL BAGS ACCESSORIES					
PRO TENTBAG					
LEGEND GEAR TAIL BAGS					
TAIL BAG LR1					
TAIL BAG LR2					
ACCESSORIES LEGEND GEAR TAIL BAGS					
ION TAIL BAGS					
ION S					
ION M					
ION L					
DRYBAGS					
DRYBAG 700					
DRYBAG 600					
DRYBAG 350					
DRYBAG 180/260					
DRYBAG 80					
ACCESSORIES DRYBAGS					
<b>SIDE CASES</b>	<b>133</b>				
TRAX ADV	134				
ACCESSORIES TRAX SIDE CASE	138				
AERO ABS SIDE CASES	142				
URBAN ABS SIDE CASES	144				
PRO SIDE CARRIERS	150				
TRAX TOOLBOX	151				
SLC SIDE CARRIERS	152				
SIDE CARRIER ACCESSORIES	154				
<b>TOP CASES</b>	<b>157</b>				
TRAX ADV	158				
TOP CASE ACCESSORIES	162				
URBAN ABS TOP CASES	164				
<b>RACKS</b>	<b>167</b>				
ADVENTURE-RACK	168				
STREET-RACK	170				
OTHER LUGGAGE SOLUTIONS	172				
<b>SAFETY</b>	<b>176</b>				
CENTERSTANDS	178				
EXTENSIONS FOR					
SIDE STAND FOOT	180				
ADJUSTABLE MIRRORS	182				
MIRROR EXTENSIONS	184				
EVO LIGHTS	186				
ACCESSORIES	188				
<b>PROTECTION</b>	<b>190</b>				
CRASH BARS	194				
CRASH PADS	200				
ENGINE GUARDS	204				
HANDGUARDS & LEVER GUARDS	210				
KOBRA HANDGUARDS	210				
LEVER GUARDS	212				
BARKBUSTERS HANDGUARDS	214				
<b>ERGONOMICS</b>	<b>216</b>				
EXTENSION FOR BRAKE PEDAL	218				
FOOTRESTS	220				
EVO FOOTPEGS	220				
ION FOOTRESTS	223				
GEAR LEVER	224				
BAR RISERS	226				
SEAT MODIFICATIONS	230				
CUSHION	232				
<b>NAVIGATION</b>	<b>234</b>				
T-LOCK	238				
NAVI- & SMARTPHONE-CASE	240				
UNIVERSAL KITS	242				
GPS HOLDERS	244				
<b>GEAR SHOP</b>	<b>246</b>				