

Invacare® Mirage

en Power Wheelchair User Manual



This manual **MUST** be given to the user of the product.
BEFORE using this product, read this manual and save for future reference.



Yes, you can.®

© 2017 Invacare Corporation

All rights reserved. Reproduction, duplication or modification in whole or in part is prohibited without prior written permission from Invacare. Trademarks are identified by ™ and ®. All trademarks are owned by or licensed to Invacare Corporation or its subsidiaries unless otherwise noted.

Invacare reserves the right to alter product specifications without further notice.

Contents

1 General	5		
1.1 Introduction	5		
1.2 Symbols in this manual	5		
1.3 Intended use	6		
1.4 Indications	6		
1.5 Type classification	6		
1.6 Regulations	6		
1.7 Usability	6		
1.8 Warranty	7		
1.9 Service life	7		
1.10 Limitation of liability	7		
2 Safety	8		
2.1 General safety notes	8		
2.2 Safety information on the electrical system	10		
2.3 Safety information on electromagnetic interference	12		
2.4 Safety information on driving and freewheel mode	13		
2.5 Safety information with regard to care and maintenance	16		
2.6 Safety information regarding changes and modifications to the mobility device	17		
2.7 Labels on product	19		
3 Components	22		
3.1 Main parts of the wheelchair	22		
3.2 Remotes	22		
4 Accessories	23		
4.1 Posture belts	23		
4.1.1 Types of posture belts	23		
4.1.2 Adjusting the posture belt correctly	23		
4.2 Using the cane holder	24		
5 Setup	25		
5.1 General setup information	25		
5.2 Adjustment possibility for remote	26		
5.2.1 Adjusting the remote for the length of the user's arm	27		
5.2.2 Adjusting the height of the remote	27		
5.2.3 Adjusting the height of the remote (only for swing-away remote supports)	27		
5.2.4 Swivelling the remote to the side	27		
5.3 Adjusting the armrests	28		
5.3.1 Adjusting the height of the armrests	28		
5.3.2 Adjusting the width of the armrests	28		
5.4 Adjusting the backrest	29		
5.4.1 Gas spring angle adjustment	29		
5.4.2 Manual angle adjustment	29		
5.4.3 Adjusting the tension adjustable backrest upholstery	30		
5.5 Folding the backrest over	30		
5.6 Adjusting the headrest	31		
5.6.1 Adjust headrest position and height	32		
5.7 Adjusting and removing the tray	32		
5.7.1 Laterally adjusting the tray	32		
5.7.2 Adjusting the depth of the tray / removing the tray	33		
5.7.3 Swinging the tray away to the side	33		
5.8 Standard 80° footrest	33		
5.8.1 Swivel the footrests outwards and/or remove them	33		
5.8.2 Adjusting the length	34		
5.9 Manually height-adjustable legrest	34		
5.9.1 Swivelling the legrest outward and/or removing	34		
5.9.2 Setting the angle	34		
5.9.3 Adjusting the length of the legrest	35		
5.9.4 Adjusting the depth of the calf pad	35		
5.9.5 Adjusting the height of the calf pad	36		
5.9.6 Adjusting the angle- and depth-adjustable foot plate	36		
5.9.7 Adjusting the head light	36		

6 Usage	38
6.1 Driving	38
6.2 Before driving for the first time	38
6.3 Swinging the curb climber rearward to get in and out of the power wheelchair	38
6.4 Parking and stationary	39
6.4.1 Activating and deactivating the manual wheel lock	39
6.5 Getting in and out of the mobility device	39
6.5.1 Removing the standard armrest in order to side transfer	39
6.5.2 Information about getting in and out	39
6.6 Taking Obstacles	40
6.6.1 Maximum obstacle height	40
6.6.2 Safety information when taking obstacles	40
6.6.3 The correct way to take obstacles	41
6.7 Driving up and down gradients	41
6.8 Use on public roads	42
6.9 Pushing the mobility device in freewheel mode	42
6.9.1 Disengaging motors	43
7 Controls system	44
7.1 Controls protection system	44
7.1.1 The main circuit breakers	44
7.2 Batteries	44
7.2.1 General information on charging	44
7.2.2 General instructions on charging	45
7.2.3 How to charge the batteries	45
7.2.4 How to disconnect the mobility device after charging	46
7.2.5 Storage and Maintenance	46
7.2.6 Instructions on using the batteries	46
7.2.7 Transporting batteries	47
7.2.8 General instructions on handling the batteries	47
7.2.9 How to handle damaged batteries correctly	48
7.2.10 Removing the batteries	48

8 Transport	50
8.1 Transport — General information	50
8.2 Transferring the mobility device to a vehicle	50
8.3 Use of the mobility device as a seat in a vehicle	51
8.3.1 How the mobility device is anchored in a vehicle	52
8.3.2 How the user is secured within the mobility device	53
8.4 Transporting the mobility device without occupant	55
8.5 Disassembling the wheelchair for transport	55
8.5.1 Removing the curb climber	56
8.5.2 Removing backrest frame cross strut	56
8.5.3 Folding the wheelchair	57
8.6 Reassembling the wheelchair	58
9 Maintenance	59
9.1 Maintenance introduction	59
9.2 Cleaning the mobility device	59
9.3 Inspection checks	59
9.3.1 Before each use of the mobility device	59
9.3.2 Weekly	60
9.3.3 Monthly	60
9.4 Wheels and tires	61
9.5 Short-term storage	62
9.6 Long-term storage	62
10 After Use	64
10.1 Reconditioning	64
10.2 Disposal	64
11 Technical Data	65
11.1 Technical specifications	65
12 Service	70
12.1 Inspections performed	70

1 General

1.1 Introduction

Thank you for choosing an Invacare product.

This user manual contains important information about the handling of the product. In order to ensure safety when using the product, read the user manual carefully and follow the safety instructions.

Before reading this manual, make sure you have the latest version. You find the latest version as a pdf on the Invacare website (see back page of this manual). If you find that the font size in the print version of the user manual is difficult to read, you can download the pdf from the website. The pdf can then be scaled on screen to a font size that is more comfortable for you.

This mobility device has been constructed for a large circle of users with different requirements.

The decision whether the model is suitable for the user may only be taken by medical specialists with appropriate expertise.

Some maintenance and settings can be performed by the user or his/hers attendants. Certain adjustments do however require technical training and may only be carried out by your Invacare specialist provider. Refer to the Inspection checks chapter in *9 Maintenance, page 59*. Damages and errors caused by nonobservance of the user manual or as a result of incorrect maintenance are excluded from all guarantees.

For more information about the product, for example product safety notices and product recalls, contact your local Invacare representative. For address and website see back page of this manual.

1.2 Symbols in this manual

In this manual, hazard statements are indicated by symbols. The symbols are accompanied by a signal word that indicates the severity of the risk.



WARNING

Indicates a hazardous situation that could result in serious injury or death if it is not avoided.



CAUTION

Indicates a hazardous situation that could result in minor or slight injury if it is not avoided.



IMPORTANT

Indicates a hazardous situation that could result in damage to property if it is not avoided.



Gives useful tips, recommendations and information for efficient, trouble-free use.



This product complies with Directive 93/42/EEC concerning medical devices. The launch date of this product is stated in the CE declaration of conformity.



This symbol identifies a list of various tools, components and items which you will need in order to carry out certain work.

1.3 Intended use

This mobility device was designed for persons whose ability to walk is impaired, but who are still in terms of their eyesight and physically and mentally able to operate an electric mobility device.

1.4 Indications

The use of this power wheelchair is recommended for the following indications:

- The inability or a greatly restricted ability to walk within the scope of the basic requirement to be able to move within one's own four walls.
- The need to leave the dwelling place in order to get some fresh air during a short walk or to reach those places generally to be found at close distance to the dwelling and where everyday business is carried out.

Provision of power wheelchairs for interior and exterior areas is advisable if the use of hand-operated wheelchairs is no longer possible on account of the disability, yet proper operation of an electromotive drive unit is still practicable.

Contraindications

There are no contraindications known.

1.5 Type classification

This vehicle has been classified according to EN 12184 as a **class B mobility product** (for indoor and outdoor areas). It is therefore compact and agile enough for indoor areas, but also able to overcome many obstacles in outdoor areas.

1.6 Regulations

The vehicle was successfully tested according to German and international standards as to its safety. It satisfies the requirements according to RoHS 2011/65/EU, REACH 1907/2006/EC and DIN EN 12184 including EN 1021-2 and ISO 7176-14. It was also tested successfully according to EN 60529 IPX4 as to its resistance to spray water, and is therefore well suited for weather conditions such as typical European weather conditions. When equipped with an appropriate lighting system, the vehicle is suitable for use on public roads.

1.7 Usability

Only use a mobility device when it is in perfect working order. Otherwise, you might put yourself and others at risk.

The following list does not claim to be exhaustive. It is only intended to show some of the situations that could affect the usability of your mobility device.

In certain situations, you should immediately stop using your mobility device. Other situations allow you to use the mobility device to get to your provider.

You should immediately stop using your mobility device if its usability is restricted due to:

- brake failure

You should immediately contact an authorized Invacare provider if the usability of your mobility device is restricted due to:

- the lighting system (if fitted) failing or being defective
- reflectors falling off
- worn thread or insufficient tire pressure

- damage to the armrests (e.g. torn armrest padding)
- damage to the legrest hangers (e.g. missing or torn heel straps)
- damage to the postural belt
- damage to the joystick (joystick cannot be moved into the neutral position)
- cables that are damaged, kinked, pinched or have come loose from the fixation
- the mobility device drifting when braking
- the mobility device pulling to one side when moving
- unusual sounds developing or occurring

Or if you have the feeling that something is wrong with your mobility device.

1.8 Warranty

The terms and conditions of the warranty are part of the general terms and conditions particular to the individual countries in which this product is sold.

1.9 Service life

We estimate a service life of five years for this product, provided it is used in strict accordance with the intended use as set out in this document and all maintenance and service requirements are met. The estimated service life can be exceeded if the product is carefully used and properly maintained, and provided technical and scientific advances do not result in technical limitations. The service life can also be considerably reduced by extreme or incorrect usage. The fact that we estimate a service life for this product does not constitute an additional warranty.

1.10 Limitation of liability

Invacare accepts no liability for damage arising from:

- Non-compliance with the user manual
- Incorrect use
- Natural wear and tear
- Incorrect assembly or set-up by the purchaser or a third party
- Technical modifications
- Unauthorized modifications and/or use of unsuitable spare parts

2 Safety

2.1 General safety notes

**DANGER!****Risk of Death, Serious Injury, or Damage**

Lighted cigarettes dropped onto an upholstered seating system can cause a fire resulting in death, serious injury, or damage. Mobility device occupants are at particular risk of death or serious injury from these fires and resulting fumes because they may not have the ability to move away from the mobility device.

- DO NOT smoke while using this mobility device.

**WARNING!****Risk of injury if mobility device is used in any other way than the purpose described in this manual**

- Only ever use the mobility device in accordance with the instructions in this user manual.
- Pay strict attention to the safety information.

**WARNING!****Risk of injury if the mobility device is driven when ability to operate a vehicle is impaired by medication or alcohol**

- Never drive the mobility device under the influence of medication or alcohol. If necessary, the mobility device must be operated by an attendant who is physically and mentally able.

**WARNING!****Risk of damage or injury if mobility device is accidentally set into motion**

- Switch the mobility device off before you get in, get out or handle unwieldy objects.
- When the drive is disengaged, the brake inside the drive is deactivated. For this reason, pushing the mobility device by an attendant is only recommended on flat surfaces, never on gradients. Never leave your mobility device on a gradient with its motors disengaged. Always re-engage the motors immediately after pushing the mobility device (refer to Pushing the mobility device in freewheel mode).

**WARNING!****Risk of injury if the mobility device is switched off while driving, for example by pressing the On/Off Button or disconnecting a cable, due to it coming to an abrupt, sharp stop**

- If you have to brake in an emergency, simply release the joystick which will bring you to a halt (refer to the remote user manual for more information).

**WARNING!****Risk of injury when transferring mobility device to a vehicle for transport with the occupant seated in it**

- It is always better to transfer the mobility device to a vehicle without the occupant seated in it.
- If the mobility device needs to be loaded up a ramp together with its driver, ensure that the ramp does not exceed the rated slope (refer to *11 Technical Data, page 65*).
- If the mobility device does need to be loaded using a ramp which exceeds the rated slope (refer to *11 Technical Data, page 65*), then you must use a winch. An attendant can safely monitor and assist the loading process.
- As an alternative you can use a platform lift. Ensure that the total weight of the mobility device including the user does not exceed the maximum permissible weight for the platform lift or winch if you are using.

**WARNING!****Risk of falling out of the mobility device**

- Do not slide forward on the seat, do not lean forward between your knees, do not lean backwards out over the top of the backrest, for example to reach an object.
- If a posture belt is installed, it should be correctly adjusted and used each time you use the mobility device.
- When transferring to a different seat, position the mobility device as close as possible to the new seat.

**WARNING!****Risk of Serious Injury or Damage**

- Storing or using the mobility device near open flame or combustible products can result in serious injury or damage.
- Avoid storing or using the mobility device near open flame or combustible products.

**CAUTION!****Risk of injury if maximum permissible load is exceeded**

- Do not exceed the maximum permissible load (refer to *11 Technical Data, page 65*).
- The mobility device is only designed for use by a single occupant whose maximum weight does not exceed the maximum permissible load of the device. Never use the mobility device to transport more than one person.



CAUTION!

Risk of injury due to wrong lifting or dropping of heavy components

- When maintaining, servicing or lifting any part of your mobility device, take into account the weight of the individual components especially the batteries. Be sure at all times to adopt the correct lifting posture and ask for assistance if necessary.



CAUTION!

Risk of injury by moving parts

- Make sure that no injury is incurred by moving parts of the mobility device, like wheels or one of the lifter modules (if fitted), especially when children are around.



CAUTION!

Risk of injury from hot surfaces

- Do not leave the mobility device in direct sunlight for prolonged periods. Metal parts and surfaces such as the seat and armrests can become very hot.



CAUTION!

Risk of fire or breaking down due to electric devices being connected

- Do not connect any electric devices to your mobility device that are not expressly certified by Invacare for this purpose. Have all electrical installations done by your authorized Invacare provider.

2.2 Safety information on the electrical system



WARNING!

Risk of death, serious injury or damage

- Misuse of the mobility device may cause the mobility device to start smoking, sparking, or burning. Death, serious injury, or damage may occur due to fire.
- DO NOT use the mobility device other than its intended purpose.
 - If the mobility device starts smoking, sparking, or burning, discontinue using the mobility device and seek service IMMEDIATELY.



WARNING!

Risk of fire

- Switched on lamps produce heat. If you cover the lamps with fabrics such as clothes, there is a risk that the fabric may catch fire.
- NEVER cover the light system with fabric.

**WARNING!****Risk of death, serious injury or damage when carrying along oxygen systems**

Textiles and other materials that normally would not burn are easily ignited and burn with great intensity in oxygen enriched air.

- Check the oxygen tubing daily, from the cylinder to the delivery site, for leaks and hold away from electrical sparks and any source of ignition.

**WARNING!****Risk of injury or damage due to electrical shorts**

Connector pins on cables connected to the power module can still be live even when the system is off.

- Cables with live pins should be connected, restrained or covered (with non-conductive materials) so that they are not exposed to human contact or materials that could cause electrical shorts.
- When cables with live pins have to be disconnected, for example, when removing the bus cable from the remote for safety reasons, make sure to restrain or cover the pins (with non-conductive materials).

**WARNING!****Risk of death, serious injury, or damage**

Corroded electrical components due to water or liquid exposure can result in death, serious injury, or damage.

- Minimize exposure of electrical components to water and/or liquids.
- Electrical components damaged by corrosion **MUST** be replaced immediately.
- Mobility devices that are frequently exposed to water/liquids may require replacement of electrical components more frequently.

**WARNING!****Risk of death or serious injury**

Failure to observe these warnings can cause an electrical short resulting in death, serious injury, or damage to the electrical system.

- The POSITIVE (+) RED battery cable MUST connect to the POSITIVE (+) battery terminal(s)/post(s). The NEGATIVE (-) BLACK battery cable MUST connect to the NEGATIVE (-) battery terminal(s)/post(s).
- NEVER allow any of your tools and/or battery cable(s) to contact BOTH battery post(s) at the same time. An electrical short may occur and serious injury or damage may occur.
- Install protective caps on positive and negative battery terminals.
- Replace cable(s) immediately if cable(s) insulation becomes damaged.
- DO NOT remove fuse or mounting hardware from POSITIVE (+) red battery cable mounting screw.

**WARNING!****Risk of death or serious injury**

Electric shock can cause death or serious injury

- To avoid electric shock, inspect plug and cord for cuts and/or frayed wires. Replace cut cords or frayed wires immediately.

**Risk of damage to the mobility device**

A failure in the electric system can lead to unusual behavior such as noises from the magnetic brakes.

- If a failure exists, switch off the remote and switch it on again.
- If a failure still exists, then disconnect or remove the power source. Depending on the mobility device model, you can either remove the battery packs or disconnect the batteries from the power module. If in doubt which cable to disconnect, contact your provider.
- In any case, contact your provider.

2.3 Safety information on electromagnetic interference

This electric vehicle was successfully tested in accordance with International standards as to its compliance with Electromagnetic Interference (EMI) regulations. However, electromagnetic fields, such as those generated by radio and television transmitters, and cellular phones can influence the functions of electric vehicles. Also, the electronics used in our vehicles can generate a low level of electromagnetic interference, which however will remain within the tolerance permitted by law. For these reasons we ask you to please observe the following precautions:

**WARNING!****Risk of malfunction due to electromagnetic interference**

- Do not switch on or operate portable transceivers or communication devices (such as radio transceivers or cellular phones) when the vehicle is switched on.
- Avoid getting near strong radio and television transmitters.
- In case the vehicle should be set in motion unintentionally or the brakes are released, switch it off immediately.
- Adding electrical accessories and other components or modifying the vehicle in any way can make it susceptible to electromagnetic interference. Keep in mind that there is no sure way to determine the effect such modifications will have on the overall immunity of the electronic system.
- Report all occurrences of unintentional movement of the vehicle, or release of the electric brakes to the manufacturer.

2.4 Safety information on driving and freewheel mode

**DANGER!****Risk of death, serious injury, or damage**

- Malfunctioning joystick could cause unintended/erratic movement resulting in death, serious injury, or damage
- If unintended/erratic movement occurs, stop using the wheelchair immediately and contact a qualified technician.

**WARNING!****Risk of injury if the mobility device tips over**

- Inclines and declines can only be travelled up to the maximum safe slope (refer to *11 Technical Data, page 65*).
- Always return the backrest of your seat or the seat tilt to an upright position before ascending slopes. We recommend that you position the seat backrest and the seat tilt (if fitted) slightly to the rear before descending slopes.
- Only ever drive downhill at a maximum of 2/3 of the top speed. Avoid abrupt braking or accelerating on gradients.
- If at all possible, avoid driving on wet, slippery, icy, or oily surfaces (such as snow, gravel, ice etc.) where there is a risk of you losing control over the vehicle, especially on a gradient. This may include certain painted or otherwise treated wood surfaces. If driving on such a surface is inevitable, then always drive slowly and with the utmost caution.
- Never attempt to overcome an obstacle when on an uphill or downhill gradient.
- Never attempt to drive up or down a flight of steps with your mobility device.
- When overcoming obstacles, always observe the maximum obstacle height (refer to *11 Technical Data, page 65* and information about overcoming obstacles in *6.6 Taking Obstacles, page 40*).
- Avoid shifting your center of gravity as well as abrupt joystick movements and changes of direction when the mobility device is in motion.

**WARNING!****Risk of injury if the mobility device tips over (continued)**

- Never use the mobility device to transport more than one person.
- Do not exceed the overall maximum permissible load or the maximum load per axle (refer to *11 Technical Data, page 65*).
- Note that the mobility device will brake or accelerate if you change the driving mode whilst the mobility device is in motion.

**WARNING!****Risk of serious injury or damage**

- Improper positioning while leaning or bending could cause the wheelchair to tip forward resulting in serious injury or damage
- To assure stability and proper operation of your mobility device, you must at all times maintain proper balance. Your power wheelchair has been designed to remain upright and stable during normal daily activities as long as you DO NOT move beyond the center of gravity.
 - DO NOT lean forward out of the mobility device any further than the length of the armrests.
 - DO NOT attempt to reach objects if you have to move forward in the seat or pick them up from the floor by reaching down between your knees.

**WARNING!**

Risk of breaking down in adverse weather conditions, i.e. extreme cold, in an isolated area

- If you are a user with severely limited mobility, we advise that in the case of adverse weather conditions DO NOT attempt a journey without an accompanying attendant.

**WARNING!**

Risk of injury if your foot slides off the footrest and gets caught underneath the mobility device when it is in motion

- Make sure each time before you drive the mobility device that your feet are squarely and securely in place on the footplates, and that both legrests are properly locked into place.

**WARNING!**

Risk of injury if you collide with an obstacle when driving through narrow passages such as doorways and entrances

- Drive through narrow passages in the lowest driving mode and with due caution.

**WARNING!**

Risk of injury

- If your mobility device has been fitted with elevating legrests, there is a risk of personal injury and damage to the mobility device if you drive the mobility device with the legrests raised.
- To avoid unwanted displacement of the mobility device center of gravity to the front (especially when travelling downhill) and in order to avoid damage to the mobility device, elevating legrests must always be lowered during normal travelling.

**WARNING!**

Tipping hazard if antitippers are removed, damaged or changed to a position different to the factory settings

- Antitippers should only ever be removed for dismantling the mobility device for transport in a vehicle or for storage.
- The antitippers must always be fitted if the mobility device is being used.



WARNING!

Risk of tipping

Antitippers (stabilizers) are only effective on firm ground. They sink in on soft ground such as grass, snow or mud if the mobility device rests itself on them. They lose their effect and the mobility device can tip over.

- Only drive with extreme care on soft ground, especially during uphill and downhill journeys. In the process pay increased attention to the tip stability of the mobility device.



CAUTION!

Risk of injury from the backrest folding over during use

If the folding backrest has not engaged properly, it may fold backwards unexpectedly when load is placed on it and you may fall from the wheelchair.

- Before using the wheelchair, make sure that the backrest is folded up and the hinges have engaged.

2.5 Safety information with regard to care and maintenance



WARNING!

Risk of death, serious injury, or damage

Incorrect repair and/or servicing of this mobility device performed by users/caregivers or unqualified technicians can result in death, serious injury, or damage.

- DO NOT attempt to carry out maintenance work that is not described in this user manual. Such repair and/or service MUST be performed by a qualified technician. Contact a provider or Invacare technician.

**CAUTION!****Risk of accident and loss of warranty if maintenance is insufficient**

- For reasons of safety and in order to avoid accidents which result from unnoticed wear, it is important that this mobility device undergoes an inspection once every year under normal operating conditions (see inspection plan contained in service instructions).
- Under difficult operating conditions such as daily travel on steep slopes, or in the case of use in medical care cases with frequently changing mobility device users, it would be expedient to carry out intermediate checks on the brakes, accessories and running gear.
- If the mobility device is to be operated on public roads, the vehicle driver is responsible for ensuring that it is in an operationally reliable condition. Inadequate or neglected care and maintenance of the mobility device will result in a limitation of the manufacturer's liability.

2.6 Safety information regarding changes and modifications to the mobility device

**WARNING!****Risk of serious injury or damage**

Use of incorrect or improper replacement (service) parts may cause injury or damage

- Replacement parts **MUST** match original Invacare parts.
- Always provide the wheelchair serial number to assist in ordering the correct replacement parts.



CAUTION!

Risk of injuries and damage to mobility device due to unapproved components and accessory parts

Seating systems, additions and accessory parts which have not been approved by Invacare for use with this mobility device can affect the tipping stability and increase tipping hazards.

- Only ever use seating systems, additions and accessory parts which have been approved by Invacare for this mobility device.

Seating systems which are not approved by Invacare for use with this mobility device do not, under certain circumstances, comply with the valid standards and could increase the flammability and the risk of skin irritation.

- Only use seating systems that have been approved by Invacare for this mobility device.

Electrical and electronic components which have not been approved by Invacare for use with this mobility device can cause fire hazards and lead to electromagnetic damage.

- Only ever use electrical and electronic components which have been approved by Invacare for this mobility device.

Batteries which have not been approved by Invacare for use with this mobility device can cause chemical burns.

- Only ever use batteries which have been approved by Invacare for this mobility device.



CAUTION!

Risk of injuries, and damage to the mobility device, if unapproved backrests are used

A retrofitted backrest which is not approved by Invacare for use with this mobility device may overload the backrest tube and thus increase the risk of injuries and of damage to the mobility device.

- Please contact your Invacare specialist provider who will perform risk analyses, calculations, stability checks etc. to ensure that the backrest can be used safely.



CE marking of the mobility device

- The conformity assessment/CE marking was carried out in accordance with Directive 93/42 EEC and only applies to the complete product.
- The CE marking is invalidated if components or accessories are replaced or added that have not been approved for this product by Invacare.
- In this case, the company that adds or replaces the components or accessories is responsible for the conformity assessment/CE marking or for registering the mobility device as a special design and for the relevant documentation.







Important information about maintenance work tools

– Some maintenance work which is described in this manual and can be carried out by the user without problems require the correct tools for proper work. If you do not have the correct tool available we do not recommend that you try to carry out the relevant work. In this case, we urgently recommend that you contact an authorized specialist workshop.

2.7 Labels on product







A		<p>If the mobility device is fitted with a tray, it is imperative that it is removed and safely stowed when transporting the mobility device in a vehicle.</p>
B	<p>Identification of the tie-down points at the front and back:</p>	<p>If the symbol appears on a bright yellow sticker, the tie-down point is suitable for fixation of the mobility device in a vehicle for use as a vehicle seat.</p>
C		<p>Warning that the mobility device may not be used as a vehicle seat</p> <p>This mobility device does not satisfy the requirements of ISO 7176-19.</p>
		<p>Identification label sticker on the chassis at the right.</p> <p>For details see below.</p>

D		<p>Identification of the position of the coupling lever for driving and push operation (only the right side visible in the picture).</p>
E		<p>Indication of service-free wheel hub screw</p>
F		<p>Indication of the maximum width to which the armrest can be set</p>
G		<p>Maximum speed label on the remote. The maximum speed is reduced to 3 km/h.</p>
H		<p>Indication of pinch points that could occur on the mobility device</p>

	<p>This product has been supplied from an environmentally aware manufacturer. This product may contain substances that could be harmful to the environment if disposed of in places (landfills) that are not appropriate according to legislation.</p> <ul style="list-style-type: none"> • The 'crossed out wheellie bin' symbol is placed on this product to encourage you to recycle wherever possible. • Please be environmentally responsible and recycle this product through your recycling facility at its end of life.
--	---

Explanation of symbols on labels

	<p>Date of manufacture</p>
	<p>This product complies with Directive 93/42/EEC concerning medical devices. The launch date of this product is stated in the CE declaration of conformity.</p>

 <p>A warning symbol consisting of a rectangular box. At the top, the word "WARNING" is written in a small font. Below it, the word "DISENGAGE" is written above a diagram of a coupling lever in its horizontal position. Below the diagram, the word "ENGAGE" is written above the same lever in its vertical position.</p>	<p>This symbol indicates the “Drive” and “Push” position of the coupling lever:</p> <ul style="list-style-type: none">• ENGAGE: In this position the motor is engaged and the motor brakes are operational. You can drive the mobility device.<ul style="list-style-type: none">– Note that for driving purposes both motors must always be engaged.• DISENGAGE: In this position the motor is disengaged and the motor brakes are not operational. The mobility device can be pushed by an attendant and the wheels turn freely.<ul style="list-style-type: none">– Note that the remote must be switched off.– Also note the information provided in section 6.9 <i>Pushing the mobility device in freewheel mode</i>, page 42.
 <p>A circular icon with a black background and a white silhouette of a person sitting and reading a book or manual.</p>	<p>Read the user manual</p>

3 Components

and how to operate a particular remote, refer to its corresponding user manual (enclosed).

3.1 Main parts of the wheelchair



- 1 Push handle cross-strut
- 2 Locking screw for adjusting armrest height
- 3 Locking screw for adjusting backrest angle
- 4 Manual wheel lock (only right side visible in the picture)
- 5 Disengaging lever (not visible in the picture, located on both sides on each motor)
- 6 Remote
- 7 Legrest unlocking lever

3.2 Remotes

Your mobility device may be fitted with one of several different remotes. For information on the different functions

4 Accessories

4.1 Posture belts

A posture belt is an option which can either be fixed to the mobility device ex-works or can be retrofitted by your specialist provider. If your mobility device is fitted with a posture belt, your specialist provider will have informed you about fitting and usage.

The posture belt is used to help the mobility device user keep an optimum seating position. Correct use of the belt assists the user in sitting securely, comfortably and well-positioned in the mobility device, especially for such users who do not have such a good sense of balance while sitting.



We recommend using the posture belt whenever the mobility device is used.

4.1.1 Types of posture belts

Your mobility device can be fitted with the following posture belt types ex-works. If your mobility device has been fitted with a different belt to those listed below, please ensure that you have received the manufacturer's documentation with regard to correct fitting and use.

Belt with metal buckle, adjustable one side



Belt can only be adjusted on one side which can result in the buckle not sitting centrally.

Belt with metal buckle, adjustable both sides



Belt can be adjusted on both sides. This means that the buckle can be centrally positioned.

4.1.2 Adjusting the posture belt correctly



The belt should be tight enough to ensure that you are sitting comfortably and that your body is in the correct sitting position.

1. Ensure that you are sitting correctly, which means that you are sitting right at the back of the seat, your pelvis is positioned erect and as symmetrically as possible, not to the front, to the side or at one edge of the seat.
2. Position the posture belt so that your hipbones can be easily felt above the belt.
3. Adjust the belt length using one of the adjustment aids described above. The belt should be adjusted so that you can fit a flat hand between the belt and your body.

4. The buckle should be positioned as centrally as possible. In doing so, carry out adjustments on both sides as much as possible.
5. Check your belt every week to ensure that it is still in good working condition, to ensure it has no damage or wear, and that it is fixed properly to the mobility device. If the belt is only fastened with a bolted connection, ensure that the connection has not loosened or come undone. You can find more information about maintenance work on belts in the service manual, which is available from Invacare.

4.2 Using the cane holder

If your mobility device is fitted with a cane holder, it can be used for the safe transport of a walking cane, underarm or forearm crutches. The cane holder consists of a plastic container (bottom) and a hook-and-loop fastener (top).



CAUTION!

Risk of injury

A walking cane or crutches that are not secured during transport (on the user's lap, for example) can cause injury to the user or other persons.

- During transport, walking canes or crutches should always be secured using a cane holder.

1. Open the upper hook-and-loop fastener.
2. Place the lower end of the walking cane or the crutches in the container at the bottom.
3. The walking cane or the crutches can be secured at the upper end using the hook-and-loop fastener.

5 Setup

5.1 General setup information



WARNING!

Risk of death, serious injury, or damage

Continued use of the mobility device that is not set to the correct specifications may cause erratic behavior of the mobility device resulting in death, serious injury, or damage.

- Performance adjustments should only be made by professionals of the healthcare field or persons fully conversant with this process and the driver's capabilities.
- After the mobility device has been set-up/adjusted, check to make sure that the mobility device performs to the specifications entered during the set-up procedure. If the mobility device does not perform to specifications, IMMEDIATELY turn the mobility device Off and re-enter set-up specifications. Contact Invacare, if mobility device still does not perform to correct specifications.



WARNING!

Risk of death, serious injury, or damage

Attaching hardware that is loosely secured or missing could cause instability resulting in death, serious personal injury, or property damage.

- After ANY adjustments, repair or service and before use, make sure that all attaching hardware is present and tightened securely.



WARNING!

Risk of injury or damage

Incorrect set up of this mobility device performed by users/caregivers or unqualified technicians can result in injury or damage.

- DO NOT attempt to set up this mobility device. Initial set up of this mobility device MUST be performed by a qualified technician.
- Adjustment by the user is only recommended after they have been given appropriate guidance by the healthcare professional.
- DO NOT attempt to carry out the work if you do not have the listed tools available.





CAUTION!

Damage to mobility device and accident hazard

It is possible that collisions can occur between mobility device components due to various combinations of adjustment options and their individual settings

- The mobility device is fitted with an individual, multiply adjustable seating system including adjustable legrests, armrests, a headrest or other options. These adjustment options are described in the following chapters. They are used to adapt the seat to the physical requirements and the condition of the user. When adapting the seating system and the seat functions to the user, ensure that no mobility device components collide.

 Initial setup should always be done by a healthcare professional. Adjustment by the user is only recommended after they have been given appropriate guidance by the healthcare professional.

 Note that there may be sections in this user manual, which are not relevant to your product, since this manual applies to all existing modules (on the date of printing).

Electrical adjustment options

 Refer to the user manual for your remote for more information on operating electrical adjustment options.

5.2 Adjustment possibility for remote

The following information is valid for all seating systems.



CAUTION!

Risk of the remote being pushed backwards during an accidental collision with an obstacle, such as a doorframe or table, and the joystick being jammed against the armpad if the position of the remote is adjusted and all screws are not completely tightened

This will cause the mobility device to drive forward uncontrollably and potentially injure the mobility device user and any person standing in the way.

- When adjusting the position of the remote, always make sure to tighten all screws securely.
- If this should accidentally happen, immediately switch the mobility device electronics OFF at the remote.



CAUTION!

Risk of injury

When leaning on the remote, for example, when transferring into or out of the wheelchair, the remote holder may break and the user may fall out of the chair.

- Never lean on the remote as a support for, for example, transfer.

5.2.1 Adjusting the remote for the length of the user's arm

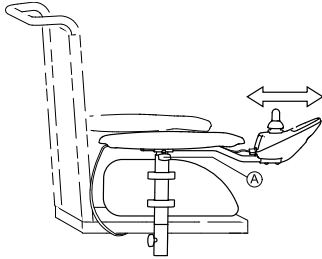

1. Loosen wing bolt (A).
2. Shift the remote forwards or backwards to the desired distance.
3. Retighten the bolt.

5.2.2 Adjusting the height of the remote

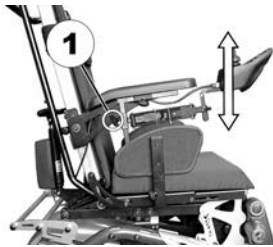

1. Loosen the wing screw (1).
2. Adjust remote to desired height.
3. Re-tighten the screw.

5.2.3 Adjusting the height of the remote (only for swing-away remote supports)



- 6 mm Allen key

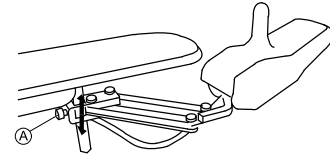

1. Loosen Allen screw (A).
2. Adjust remote to desired height.
3. Re-tighten Allen screw.

5.2.4 Swivelling the remote to the side

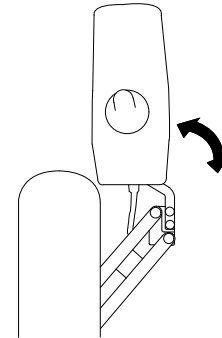

If your mobility device is fitted with a swing-away remote holder, then the remote can be moved away to the side, for example, to drive up close to a table.

5.3 Adjusting the armrests

5.3.1 Adjusting the height of the armrests

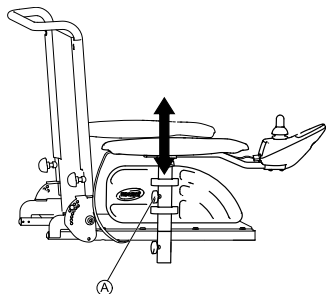

1. Loosen wing screw (A).
2. Adjust armrest to desired height.
3. Re-tighten wing screw.

5.3.2 Adjusting the width of the armrests

The distance between the armrests can be adjusted by 40 mm on both sides (80 mm in total).



WARNING!

Serious injury hazard if one of the armrests falls out of its bracket because they have been adjusted to a width which exceeds the permissible value

- The width adjustment is fitted with small stickers with markings and the word "STOP". The armrests must never be pulled out further than the point at which the word "STOP" is completely legible.
- Always tighten the fixing screws properly once adjustments have been completed.



- 5 mm Allen key



1. Loosen screw (1).
2. Adjust armrest to required position.
3. Retighten the screw.
4. Repeat this procedure for the second armrest.

5.4 Adjusting the backrest



CAUTION!

Adjusting the seat tilt or the backrest angle changes the geometry of the mobility device and directly influences its dynamic stability!

– For details regarding dynamic stability, negotiating gradients and obstacles and the correct adjustment of seat tilt or backrest angle, refer to *6.6 Taking Obstacles, page 40* and *6.7 Driving up and down gradients, page 41*.

5.4.1 Gas spring angle adjustment

The levers for adjusting the backrest are located on the push handles.

The inclination can be infinitely adjusted within a range of + 3° and + 38°.



1. Pull both levers (1) upwards.
2. Adjust backrest by moving it forward or backwards.
3. Release levers. The backrest engages.

5.4.2 Manual angle adjustment

The levers for adjusting the backrest are located on the push handles.

The inclination can be adjusted to four positions 3°, 13°, 23° and 33°.



1. Pull both levers (1) upwards.
2. Adjust backrest by moving the backrest forward or backwards.
3. Release levers. Move backrest very slightly forward or backwards till it locks in place.

5.4.3 Adjusting the tension adjustable backrest upholstery

1.



Remove the backrest cushion (attached with hook-and-loop straps) by pulling it up and off to access the adjustment straps.

2.



Adjust the tension of the individual straps as desired.

3. Replace the backrest cushion.

5.5 Folding the backrest over



WARNING!

Risk of most severe injury or death, if a wheelchair with a folding backrest is used as a vehicle seat

A wheelchair with a folding backrest does not fulfil the requirements of ISO 7176-19. Using a wheelchair that does not fulfil these requirements as a vehicle seat can lead to the most severe injuries and even death in the event of a traffic accident.

- Never use a wheelchair with a folding backrest as a vehicle seat or to transport the user in a vehicle.



CAUTION!

Risk of injury from the backrest folding over during use

If the folding backrest has not engaged properly, it may fold backwards unexpectedly when load is placed on it and you may fall from the wheelchair.

- Before using the wheelchair, make sure that the backrest is folded up and the hinges have engaged.



CAUTION!

Risk of getting fingers caught

When folding up the backrest, it is possible that you might catch your fingers in the hinges.

- Keep your fingers away from the hinges to avoid injuries.

With the folding backrest, you can fold over the top half of the backrest backwards.

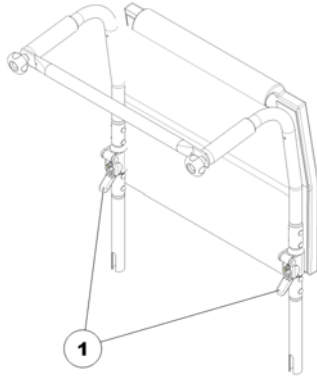

Folding the backrest over

1. Pull both levers (1) upwards.
2. Fold the upper half of the backrest backwards.

Folding the backrest up

1. Fold the upper half of the backrest up. The hinges engage audibly.

5.6 Adjusting the headrest



WARNING!

Risk of injury if the mobility device is used as a vehicle seat without a headrest

This can cause the neck to be hyperextended during collisions.

- It is recommended to use a headrest during transport. The Invacare headrest for this mobility device (available as an option) is the perfect solution for use during transport.
- The headrest must be adjusted to the user's ear height.



5.6.1 Adjust headrest position and height

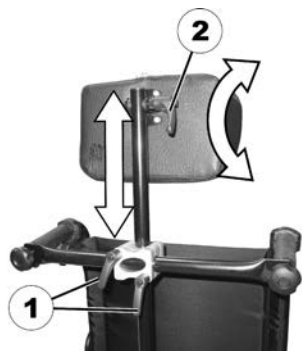

1. Loosen clamping levers (1).
2. Adjust headrest to required height.
3. Re-tighten clamping levers.
4. Loosen clamping lever (2).
5. Adjust headrest angle to required position.
6. Re-tighten clamping lever.

5.7 Adjusting and removing the tray



CAUTION!

Risk of injury or material damage if a mobility device which is fitted with a tray is transported in a vehicle

– If a tray is fitted, always remove it before transporting the mobility device.



5.7.1 Laterally adjusting the tray

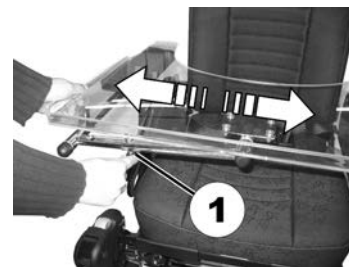

1. Loosen wing-screw (1).
2. Adjust tray towards the left or right.
3. Re-tighten wing-screw.

5.7.2 Adjusting the depth of the tray / removing the tray

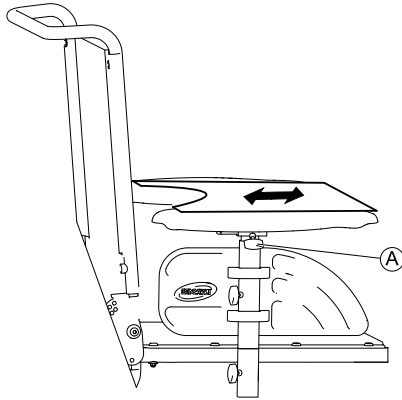

1. Loosen wing-screw (A).
2. Adjust tray to desired depth (or remove it entirely).
3. Re-tighten screw.

5.7.3 Swinging the tray away to the side

The tray can be swivelled up and away to the side to allow the user to get in and out of the mobility device.



CAUTION!

Risk of injury! When the tray is raised it does not lock in place in this position!

- Do not tilt the tray up and leave it leaning in this position.
- Never attempt to drive with the tray tilted up.
- Always lower the tray in a controlled manner.

5.8 Standard 80° footrest

5.8.1 Swivel the footrests outwards and/or remove them

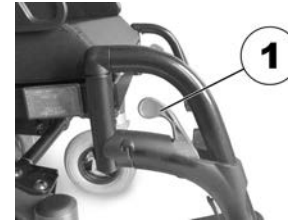

The small release lever is to be found in the upper part of the legrest (1). When the legrest is released it can be swivelled inward or outward to facilitate access and also be removed completely.



1. Push the release lever inward or outward. The legrest is released.
2. Swivel the legrest inward or outward.
3. To remove the legrest simply pull upward.

5.8.2 Adjusting the length



- 5 mm Allen key



1. Loosen the screw (1) using the Allen key, but do not remove completely.
2. Set the legrest to the desired length.
3. Re-tighten the screw.

5.9 Manually height-adjustable legrest

5.9.1 Swivelling the legrest outward and/or removing

The unlocking knob is located on the top section of the legrests. When the legrest is unlocked, it can be swivelled to the inside or outside to facilitate getting in, or can be completely removed.

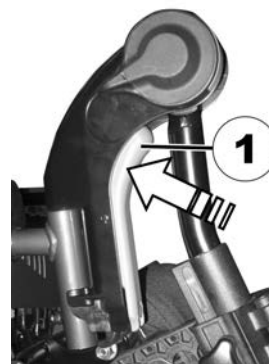

1. Press unlocking knob (1) and remove legrests upwards.

5.9.2 Setting the angle



CAUTION!

Risk of crushing

- Do not reach inside the swivelling range of the legrest.



CAUTION!

Risk of injury due to incorrect adjustment of the footrests and legrests

- Before and during every journey it is imperative to ensure that the legrests contact neither the caster wheels nor the ground.



1. Press the unlocking lever (1) down. Adjust the legrest to the required angle.
2. Release the unlocking lever. The legrest engages.

5.9.3 Adjusting the length of the legrest



CAUTION!

Risk of injury due to incorrect adjustment of the footrests and legrests

– Before and during every journey it is imperative to ensure that the legrests contact neither the caster wheels nor the ground.



- 5 mm Allen key

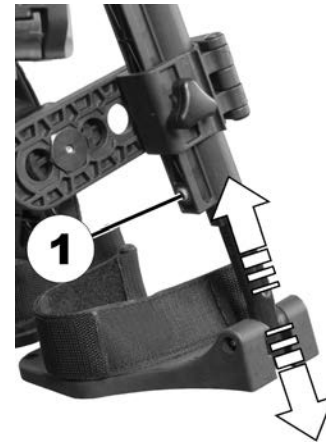

1. Loosen bolt (1) with the Allen key.
2. Adjust to required length.
3. Retighten screw.

5.9.4 Adjusting the depth of the calf pad

The calf pad has four depth settings.



- 4 mm Allen key



1. Swivel the calf pad to the front.
2. Release bolt (1) with the Allen key and remove.
3. Set the nut on the other side to the required depth.
4. Adjust the calf pad to match the depth of the nut, put the screw back in and tighten.

5.9.5 Adjusting the height of the calf pad



1. Loosen the hand screw (1).
2. Adjust to required position.
3. Retighten the wing nuts.

5.9.6 Adjusting the angle- and depth-adjustable foot plate



- 5 mm Allen key



1. Use the Allen key to loosen the set screw on the foot plate (1).
2. Adjust the foot plate to the desired angle or depth.
3. Re-tighten the screw.

5.9.7 Adjusting the head light

If your mobility device is fitted with optional light, refer to the user manual of the lights for information about usage.



The light must be used in bad visibility conditions like darkness or fog.

Before first usage you have to adjust the head light to prevent safety issues. Adjust the head light so that you are seen well but do not dazzle other traffic.

Adjusting the head light correctly

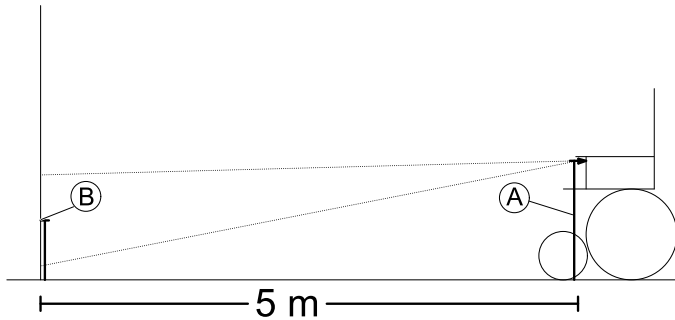

1. Adjust the head light straight ahead.
2. Measure distance between middle of head light and floor (A).
3. Mark vertical surface, e.g. a wall, which corresponds to half of determined value (A).
4. Distance between marking (B) and head light must be five meters.
5. Adjust middle of light cone to marking (B).

6 Usage

6.1 Driving



CAUTION!

Risk of unexpected driving behavior due to locked casters

If your mobility device is fitted with caster locks and these are locked, the casters cannot move freely and the mobility device might therefore not react to your steering as it should.

- Make sure the caster locks are unlocked before driving.



The maximum load capacity that is stated in the technical data only states that the system is designed for this mass in total. However, this does not mean that one can sit a person with this body weight in the mobility device without restrictions. Attention must be paid to the body proportions, such as height, weight distribution, abdominal belt, leg and calf strap and seat depth. These factors have a strong influence on driving features such as tilt stability and traction. The permissible axle loads in particular must be adhered to (refer to *11 Technical Data, page 65*). It may possibly be necessary to carry out adaptations to the seat system.

6.2 Before driving for the first time

Before you take your first trip, you should familiarize yourself well with the operation of the mobility device and with all

operating elements. Take your time to test all functions and driving modes.



If installed, make sure to properly adjust and use the posture belt each time you use the mobility device.

Sitting comfortably = Driving safely

Before each trip, make sure that:

- You are within easy reach of all operating controls.
- The battery charge is sufficient for the distance intended to be covered.
- The posture belt (if installed) is in perfect order.
- The rear mirror (if installed) is adjusted so you can look behind at all times without having to bend forward or shift your seating position.

6.3 Swinging the curb climber rearward to get in and out of the power wheelchair

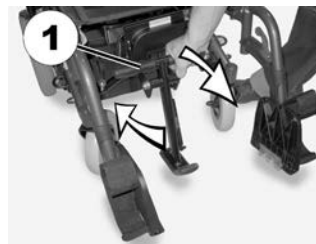

1. Pull the handle (1) all the way forward. The curb climber swings away towards the back and locks in place in this position.
2. To bring the curb climber back towards the front, push the handle (1) rearward.

6.4 Parking and stationary

When parking your vehicle or if your vehicle is stationary for a prolonged period:

1. Switch the vehicle's power system off (ON-/OFF key).
2. Activate your anti-theft lock, if existing.

6.4.1 Activating and deactivating the manual wheel lock

The manual wheel locks are located on the left and right sides above the wheels.

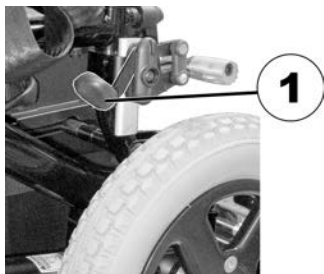

1. Pull the lever (1) upwards and backwards till it audibly locks in place. The manual wheel lock is activated.
2. To release the wheel lock, push the lever (1) completely forward and downward again.

6.5 Getting in and out of the mobility device



– The armrest must be removed or swiveled up in order to get into or out of the mobility device from the side.

6.5.1 Removing the standard armrest in order to side transfer

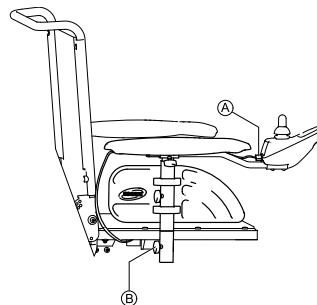

1. Pull the plug Ⓐ of the remote cable to disconnect the remote.
2. Loosen wing nut Ⓑ.
3. Remove the armrest from the holder.

6.5.2 Information about getting in and out



**WARNING!****Risk of serious injury or damage**

Improper transfer techniques may cause serious injury or damage

- Before attempting transfers, consult a healthcare professional to determine proper transfer techniques for the user and type of wheelchair.
- Follow the instructions below.



If you do not have sufficient muscle strength, you should ask other persons for help. Use a sliding board, if possible.

Getting into the mobility device:

1. Position your mobility device as close as possible to your seat. This might have to be done by an attendant.
2. Align casters parallel to the drive wheels to improve stability during transfer.
3. Always switch your mobility device off.
4. Always engage both motor locks/clutches and free wheel hubs (if fitted) to prevent the wheels from moving.
5. Depending on the armrest type of your mobility device, detach the armrest or swivel it up.
6. Now slide into the mobility device.

Getting out of the mobility device:

1. Position your mobility device as close as possible to your seat.
2. Align casters parallel to the drive wheels to improve stability during transfer.
3. Always switch your mobility device off.

4. Always engage both motor locks/clutches and free wheel hubs (if fitted) to prevent the wheels from moving.
5. Depending on the armrest type of your mobility device, detach the armrest or swivel it up.
6. Now slide onto your new seat.

6.6 Taking Obstacles**6.6.1 Maximum obstacle height**

You can find information about maximum obstacle heights in the chapter entitled *11 Technical Data*, page 65.

6.6.2 Safety information when taking obstacles**CAUTION!****Risk of tipping over**

- Never approach obstacles at an angle but at 90 degrees as shown below.
- Approach obstacles followed by a gradient with caution. If unsure whether the gradient is too steep or not, move away from the obstacle and if possible try to find another location.
- Never approach obstacles on an uneven and/or loose ground.
- Never drive with too low tire pressure.
- Put your backrest into an upright position before ascending an obstacle.

**CAUTION!**

Risk of falling out of the mobility device and damage to the mobility device such as broken casters

- Never approach obstacles that are higher than the maximum climbable obstacle height.
- Never let the footrest/legrest touch the ground when descending an obstacle.
- If unsure whether taking an obstacle is possible or not, move away from the obstacle and if possible find another location.

6.6.3 The correct way to take obstacles



The following instructions how to take obstacles also apply for attendants if the mobility device is fitted with an attendant control.

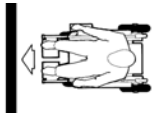

Fig. 6-1 Right



Fig. 6-2 Wrong

Ascending

1. Approach the obstacle or the curb slowly, head-on and at a right angle.
2. Depending on the wheel drive type, stop in one of the following positions:
 - a. In the case of centrally driven mobility devices: 5 - 10 cm before the obstacle.
 - b. For all other drives: approx. 30 - 50 cm in front of the obstacle.

3. Check the position of the front wheels. They must be in driving direction and at right angles to the obstacle.
4. Approach slowly and keep at a consistent speed until the rear wheels have also passed over the obstacle.

Ascending obstacles with a curb climber

1. Approach the obstacle or the curb slowly, head-on and at a right angle.
2. Stop in the following position: 30 – 50 cm in front of the obstacle.
3. Check the position of the front wheels. They must be in driving direction and at right angles to the obstacle.
4. Approach with full speed until the curb climber makes contact with the obstacle. The impetus will lift both front wheels over the obstacle.
5. Keep at a consistent speed until the rear wheels have also passed over the obstacle.

Descending

The approach to descend an obstacle is the same as to ascend it with the difference that you need not to stop before descending.

1. Descend the obstacle with medium speed.



When descending an obstacle too slowly it could happen that the antitippers get stuck and lift the drive wheels off the ground. Driving the mobility device is then no longer possible.

6.7 Driving up and down gradients

For information concerning the maximum safe slope, refer to *11 Technical Data, page 65*.

**CAUTION!****Risk of tipping over**

- Only ever drive downhill at a maximum of 2/3 of the top speed. Avoid sudden changes of direction or abrupt braking when driving on slopes.
- Always return the backrest of your seat or the seat tilt (if adjustable seat tilt is available) to an upright position before ascending slopes. We recommend that you position the seat backrest or the seat tilt slightly to the rear before descending slopes.
- Always lower the lifter (if fitted) to its lowest position before ascending or descending a slope.
- Never attempt to ascend or descend a slope on slippery surfaces or where there is a risk of skidding (such as wet pavement, ice etc).
- Avoid trying to get out of the vehicle on an incline or a gradient.
- Always drive straight in the direction the road or path you are on goes, rather than attempting to zigzag.
- Never attempt to turn around on an incline or a slope.

**CAUTION!****Braking distance is much longer on a downhill slope than on even terrain**

- Never drive down a slope that exceeds the rated slope (refer to *11 Technical Data, page 65*).

6.8 Use on public roads

If you wish to use your mobility device on public roads and lighting is required by national legislation, then your mobility device needs to be fitted with an appropriate lighting system.

Contact your Invacare provider if you have any questions.

6.9 Pushing the mobility device in freewheel mode

The motors of the mobility device are equipped with automatic brakes, preventing that the mobility device starts rolling out of control when the remote is switched off. When pushing the mobility device manually whilst freewheeling, the magnetic brakes must be disengaged.



Pushing the mobility device by hand may require more physical force than expected (more than 100 N). The necessary force nevertheless complies with the requirements of ISO 7176-14.



The intended use of the freewheel mode is to maneuver the mobility device over short distances. The push handles or push bars support this function, but be aware that there might be some impairment between the feet of the assistant and the rear part of the mobility device.

6.9.1 Disengaging motors



CAUTION!

Risk of the mobility device running away

– When the motors are disengaged (for push operation whilst freewheeling), the electromagnetic motor brakes are deactivated. When the mobility device is parked, the levers for engaging and disengaging the motors must without fail be locked firmly into the "DRIVE" position (electromagnetic motor brakes activated).



The motors may only be disengaged by an attendant, not by the user.

This ensures that the motors are only disengaged if an attendant is available to secure the mobility device and prevent unintended rolling.

The levers for disengaging the motors are located at the rear on the motors.



Disengaging motor

1. Switch off remote.
2. Rotate engaging lever (1) to the side (position B).
The motor is now disengaged.

Re-engaging motor

1. Rotate the engaging lever (1) to the rear (position A).
The motor is now re-engaged.

7 Controls system

7.1 Controls protection system

The wheelchair controls system is fitted with an overload protection.

If the drive is severely overloaded over a long period of time (for example, when driving up a steep hill) and especially when the ambient temperature is high, the controls system could overheat. In this case, the wheelchair performance is gradually reduced until it comes to a halt. The status display shows a corresponding error code (refer to the user manual for your remote). By switching the power supply off and back on again, the error code is cleared and the controls system is switched back on. It can however take up to five minutes until the controls system has cooled down enough for the drive to restore full performance again.

If the drive is stalled by an insurmountable obstacle, for example, a curb or similar which is too high, and the driver attempts driving for more than 20 seconds against this obstacle, the controls system automatically switches off to prevent the motors from being damaged. The status display shows a corresponding error code (refer to the user manual of your remote). By switching off and back on again, the error code is cleared and the controls system is switched back on.



A defective main fuse may be replaced only after checking the entire controls system. A specialized Invacare provider must perform the replacement. You can find information on the fuse type in *11 Technical Data, page 65*.

7.1.1 The main circuit breakers



The circuit breakers (1) are located on the left sides of the battery boxes as shown above. If the controls system draws too much power for a period of time, one or both may overheat and pop out.

1. To reactivate the controls system, wait a few minutes until the circuit breakers have cooled down a bit, then push them back in.

7.2 Batteries

Power is supplied by two 12 V batteries. The batteries are maintenance-free and only need regular charging.

In the following, you find information on how to charge, handle, transport, store, maintain, and use batteries.

7.2.1 General information on charging

New batteries should always be fully charged once before their first use. New batteries will be at their full capacity after having run through approx. 10 - 20 charging cycles (break-in period). This break-in period is necessary to fully activate the battery for maximum performance and longevity. Thus, range and running time of your mobility device could initially increase with use.

Gel/AGM lead acid batteries do not have a memory effect as NiCd batteries.

7.2.2 General instructions on charging

Follow the instructions listed below to ensure safe use and longevity of the batteries:

- Charge 18 hours prior to initial usage.
- We recommend charging the batteries daily after every discharge even after partly discharge, as well as each night over night. Depending on the level of discharge, it can take up to 12 hours until the batteries are fully charged again.
- When the battery indicator reached the red LED range, charge the batteries for 16 hours minimum, neglecting the charge complete display!
- Try to provide a 24 hour charge once a week to make sure that both batteries are fully charged.
- Do not cycle your batteries at a low state of charge without regularly recharging them fully.
- Do not charge your batteries under extreme temperatures. High temperatures above 30 °C are not recommended for charging as well as low temperatures below 10 °C.
- Use only charging devices in Class 2. This class of chargers may be left unattended during charging. All charging devices which are supplied by Invacare comply with these requirements.
- You cannot overcharge the batteries when using the charger supplied with your mobility device, or a charger that has been approved by Invacare.

- Protect your charger from sources of heat such as heaters and direct sunlight. If the battery charger overheats, charging current will be reduced and the charging process delayed.

7.2.3 How to charge the batteries

Refer to the user manuals for your remote and battery charger for the position of the charging socket and further information about charging the batteries.



WARNING!

Risk of explosion and destruction of batteries if the wrong battery charger is used

- Only ever use the battery charger supplied with your mobility device, or a charger that has been approved by Invacare.



WARNING!

Risk of electric shock and damage to the battery charger if it gets wet

- Protect the battery charger from water.
- Always charge in a dry environment.



WARNING!

Risk of short circuit and electric shock if the battery charger has been damaged

- Do not use the battery charger if it has been dropped or damaged.



WARNING!

Risk of electric shock and damage to the batteries

- NEVER attempt to recharge the batteries by attaching cables directly to the battery terminals.



WARNING!

Risk of fire and electric shock if a damaged extension cable is used

- Only ever use an extension cable if it is absolutely necessary. In case you must use one, make sure it is in good condition.



WARNING!

Risk of injury if using the mobility device during charging

- DO NOT attempt to recharge the batteries and operate the mobility device at the same time.
- DO NOT sit in the mobility device while charging the batteries.

1. Switch off the mobility device.
2. Connect the battery charger to the charger socket.
3. Connect the battery charger to the power supply.

7.2.4 How to disconnect the mobility device after charging

1. Once charging is complete, first disconnect the battery charger from the power supply, then disconnect the plug from the remote.

7.2.5 Storage and Maintenance

Follow the instructions listed below to ensure safe use and longevity of the batteries:

- Always store the batteries fully charged.
- Do not leave the batteries in a low state of charge for an extended length of time. Charge a discharged battery as soon as possible.
- In case your mobility device is not used for a longer period of time (that is more than two weeks), the batteries must be charged at least once a month to maintain a full charge and always be charged before use.
- Avoid hot and cold extremes when storing. We recommend to store batteries at a temperature of 15 °C.
- Gel and AGM batteries are maintenance-free. Any performance issues should be handled by a properly trained mobility device technician.

7.2.6 Instructions on using the batteries



CAUTION!

Risk of damaging the batteries.

- Avoid ultra-deep discharges and never drain your batteries completely.

- Pay attention to the Battery Charge Indicator! Charge the batteries when the Battery Charge Indicator shows that battery charge is low. How fast the batteries discharge depends on many circumstances, such as ambient temperature, condition of the surface of the road, tire pressure, weight of the driver, way of driving and utilisation of lighting, if fitted.

- Try to charge the batteries always before you reach the red LED range.
The last 3 LED (two red and one orange) mean a remaining capacity of about 15 %.
- Driving with flashing red LED's means an extreme stress for the battery and should be avoided under normal circumstances.
- When only one red LED is flashing, the Battery Safe feature is enabled. From this time, speed and acceleration is reduced drastically. It will allow you to move the mobility device slowly out of a dangerous situation before the electronic finally cuts off. This is deep discharging and should be avoided.
- Be aware that for temperatures below 20 °C, the nominal battery capacity starts to decline. For example, at -10 °C the capacity is reduced to about 50 % of the nominal battery capacity.
- To avoid damaging the batteries, never allow them to be fully discharged. Do not drive on heavily discharged batteries if it is not absolutely necessary, as this will strain the batteries unduly and shorten their life expectancy.
- The earlier you recharge the batteries, the longer they live.

- The depth of discharge affects the cycle life. The harder a battery has to work, the shorter is its life expectancy. Examples:
 - One deep discharge stresses the same as 6 normal cycles (green /orange display off).
 - The battery life is about 300 cycles at 80 % discharge (first 7 LED off), or about 3000 cycles at 10 % discharge (one LED off).
-  The number of LED can vary depending on the remote type.
- Under normal operation, once a month the battery should be discharged until all green and orange LED are off. This should be done within one day. A 16 hour charge afterwards is necessary as reconditioning.

7.2.7 Transporting batteries

The batteries supplied with your mobility device are not hazardous goods. This classification is based on the German GGVS Hazardous Goods Road Transport Ordinances, and the IATA/DGR Hazardous Goods Rail Transport / Air Transport Ordinances. Batteries may be transported without restrictions, whether by road, rail or by air. Individual transport companies have, however, guidelines which can possibly restrict or forbid certain transport procedures. Please ask the transport company regarding each individual case.

7.2.8 General instructions on handling the batteries

- Never mix and match different battery manufactures or technologies, or use batteries that do not have similar date codes.
- Never mix gel with AGM batteries.

- The batteries reach their end of life when the drive range is significantly smaller than usual. Contact your provider or service technician for details.
- Always have your batteries installed by a properly trained mobility device technician or a person with adequate knowledge. They have the necessary training and tools to do the job safely and correctly.

7.2.9 How to handle damaged batteries correctly



CAUTION!

Corrosion and burns from acid leakage if batteries are damaged

- Remove clothes that have been soiled by acid immediately.

After contact with skin:

- Immediately wash affected area with lots of water.

After contact with eyes:

- Immediately rinse eyes under running water for several minutes; consult a physician.

- Always wear safety goggles and appropriate safety clothing when handling damaged batteries.
- Place damaged batteries in an acid-resistant receptacle immediately after removing them.
- Only ever transport damaged batteries in an appropriate acid-resistant receptacle.
- Wash all objects that have come into contact with acid with lots of water.

Disposing of dead or damaged batteries correctly

Dead or damaged batteries can be given back to your provider or directly to Invacare.

7.2.10 Removing the batteries



CAUTION!

Risk of fire and burns if battery poles are bridged

- When replacing the batteries the battery poles **MUST NOT** come into contact with metal parts of the wheelchair causing bridging.
- Be sure to replace the battery pole caps after the batteries have been replaced.



CAUTION!

Risk of fire and burns due to damage to the battery cables

- The battery cables and other cables are positioned in a cable duct above the batteries. The cable duct protects the cables against crushing and other damage. It may not be removed.

1.



Open buckle of battery fixing strap.

2.



Remove battery cable connecting plugs on both sides (the figure only shows the right-hand side).

3.



Pull the rear battery box out towards the back.

8 Transport

8.1 Transport — General information



WARNING!

Risk of death or serious injury to the mobility device user and potentially any other nearby occupant of the vehicle, if a mobility device is secured using a 4-point tie-down system available from a third party supplier and the unladen weight of the mobility device exceeds the maximum weight for which the tie-down system is certified

- Make sure the weight of the mobility device does not exceed the weight for which the tie-down system is certified. Consult the tie-down manufacturer's documentation.
- If you are unsure how much your mobility device weighs, then you must have it weighed using calibrated scales.



CAUTION!

Risk of injury or material damage if a mobility device which is fitted with a tray is transported in a vehicle

- If a tray is fitted, always remove it before transporting the mobility device.



8.2 Transferring the mobility device to a vehicle



WARNING!

The mobility device is at risk of tipping over if it is transferred to a vehicle while the user is still seated in the mobility device

- Transfer the mobility device without the user whenever possible.
- If the mobility device with the user has to be transferred to a vehicle using a ramp, ensure that the ramp does not exceed the rated slope (refer to *11 Technical Data, page 65*).
- If the mobility device has to be transferred to a vehicle using a ramp that does exceed the rated slope (refer to *11 Technical Data, page 65*), a winch must then be used. An attendant can then safely monitor and assist the transfer process.
- Alternatively, a platform lift may be used.
- Ensure that the total weight of the mobility device including the user does not exceed the maximum permitted total weight for the ramp or platform lift.
- The mobility device should always be transferred to a vehicle with the backrest in an upright position, the seat lifter lowered and the seat tilt in the upright position (refer to *6.7 Driving up and down gradients, page 41*).

**WARNING!****Risk of injury and damage to the mobility device**

If the mobility device is to be transferred to a vehicle via a lift, when the remote is turned on, there is a risk that the device may act erratically and fall off the lift.

- Before transferring the mobility device via a lift, turn off the product and disconnect either the bus cable from the remote or the batteries from the system.

1. Drive or push your mobility device into the transport vehicle using a suitable ramp.

8.3 Use of the mobility device as a seat in a vehicle



The following section does not apply to models or configurations which may not be used as a vehicle seat. These are identified by the following label on the mobility device:

**WARNING!****Risk of injury**

Safety restraint devices must only be used when the wheelchair user's weight is 22 kg or more.

- When the user weight is lower than 22 kg, do not use the wheelchair as a seat in a vehicle.

**CAUTION!****Risk of injury if the mobility device is not properly secured during use as a vehicle seat.**

- If possible, the user should always leave the mobility device to use a vehicle seat and the safety belts provided with the vehicle.
- The mobility device should always be anchored facing in the transport vehicle's intended direction of travel.
- The mobility device must always be secured in accordance with the mobility device and anchoring system manufacturers' user manual.
- Always remove and secure any accessory parts fixed to the mobility device such as chin controls or tables.
- If your mobility device is fitted with an angle adjustable backrest, then it must be placed in an upright position.
- Fully lower elevated legrests, if fitted.
- Fully lower the seat lifter, if fitted.

**CAUTION!****Risk of injury if a mobility device that is not fitted with leak-proof batteries is transported in a vehicle.**

- Only ever use leak-proof batteries.



CAUTION!

Risk of injury or damage to the mobility device or to the transporting vehicle, if the legrests are in a raised position while the mobility device is used as a vehicle seat.

- Always completely lower height-adjustable legrests, if fitted.



In order to use a mobility device as a motor vehicle seat, it needs to be fitted with tie-down points to enable anchoring in the motor vehicle. These accessories may be included in the standard scope of mobility device order and delivery in some countries (UK for example), but may also be obtained from Invacare as an option in other countries.

This mobility device complies with the requirements of ISO 7176-19 and may be used as a vehicle seat in connection with an anchoring system that has been checked and approved in accordance with ISO 10542. The transporting vehicle must be professionally converted to anchor the mobility device. Contact your vehicle's manufacturer for more information.

The mobility device has undergone a crash test in which it was anchored in the transporting vehicle's direction of travel. Other configurations were not tested. The crash test dummy was secured using pelvic and upper body safety belts. Both types of safety belt should be used in order to minimize the risk of injuries to head or upper body.



Invacare tests with a 4-point tie-down system from Unwin Safety Systems.

- Contact Unwin for more information on how to obtain such a system for your country and vehicle type. For information concerning the curb weight, refer to *11 Technical Data, page 65*.

It is imperative that the mobility device is inspected by an authorized dealer before being used again after being involved in a crash. Alterations to the mobility device anchoring points may not be carried out without the manufacturer's permission.

8.3.1 How the mobility device is anchored in a vehicle

The mobility device is fitted with four tie-down points. Snap hooks or belt loops can be used for fixation. If the wheelchair can be used as a vehicle seat, these tie-down points are labelled with the symbol shown on the right.

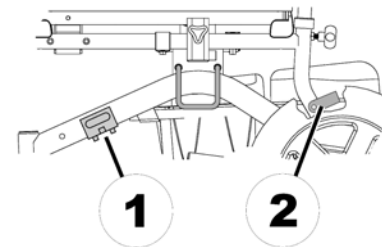



Fig. 8-1 Front



Fig. 8-2 Rear

1. Secure the mobility device at the front (1) and at the rear (2) with the tie-down system belts. The curb climber does not have to be removed.
2. Secure the mobility device by tensioning the belts in accordance with the tie-down system manufacturer's user manual.

8.3.2 How the user is secured within the mobility device



CAUTION!

Risk of injury if the user is not properly secured within the mobility device

- Even if the mobility device is fitted with a posture belt, this is no substitute for a proper safety belt which complies with ISO 10542 in the transport vehicle. Always use the safety belt installed in the transport vehicle.
- Safety belts must be in contact with the user's body. They must not be held at a distance from the user's body using parts of the mobility device such as armrests or wheels.
- Safety belts must be pulled as tightly as possible without causing the user discomfort.
- Safety belts must not be positioned while twisted.
- Ensure that the third seat belt anchorage point is not fixed directly to the vehicle floor, but to one of the vehicle uprights.



CAUTION!

Risk of injury during use of the mobility device as a vehicle seat if a headrest is wrongly adjusted or not installed

This can cause the neck to be hyperextended during collisions.

- A headrest must be installed. The headrest optionally supplied for this mobility device by Invacare is perfectly suitable for use during transport.
- The headrest must be adjusted to the user's ear height.

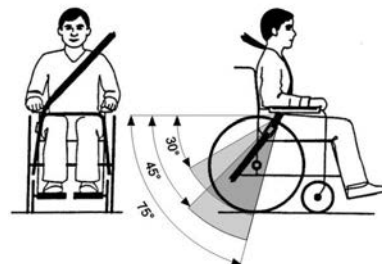

The pelvic belt should be positioned in the area between the user's pelvis and thighs so that it is unobstructed and not too loose. The ideal angle of the pelvic belt to the horizontal is between 45° and 75°. The maximum permissible angle is between 30° and 75°. The angle should never be less than 30°!

Seat belts may not be held at a distance from the user's body using parts of the mobility device such as armrests or wheels.

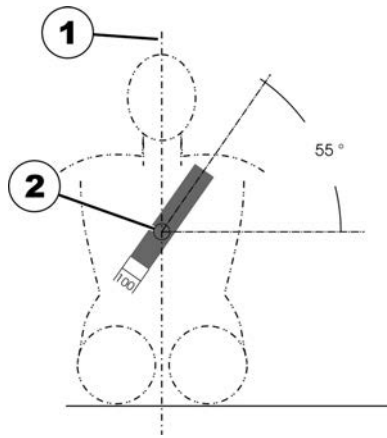

The safety belt installed in the transporting vehicle should be applied as shown in the illustration above.

- 1) Center line of the body
- 2) Center of the sternum

8.4 Transporting the mobility device without occupant



CAUTION! Risk of injury

– If you are unable to fasten your mobility device securely in a transport vehicle, Invacare recommends that you do not transport it.

Your mobility device may be transported without restrictions, whether by road, rail or by air. Individual transport companies have, however, guidelines which can possibly

restrict or forbid certain transport procedures. Please ask the transport company regarding each individual case.

- Before transporting your mobility device, make sure the motors are engaged and that the remote is switched off. Invacare strongly recommends that you additionally disconnect or remove the batteries. Refer to Removing the batteries.
- Invacare strongly recommends securing the mobility device to the floor of the transporting vehicle.

8.5 Disassembling the wheelchair for transport

To disassemble and fold the wheelchair together for transport, proceed as follows:

1. Remove legrests. Refer to the corresponding legrest chapters.
2. Remove the curb climber (available as option and not always fitted). Refer to *8.5.1 Removing the curb climber, page 56*.
3. Remove the batteries. Refer to *7.2.10 Removing the batteries, page 48*.
4. Remove the backrest frame cross strut. Refer to *8.5.2 Removing backrest frame cross strut, page 56*.
5. Fold the wheelchair together and load it. Refer to *8.5.3 Folding the wheelchair, page 57*.

8.5.1 Removing the curb climber



The curb climber is fitted with quick release axles.

The quick release axles are fitted with securing balls (1) which prevent the quick release axles sliding out of the mounting. The securing balls are released by pressing in the unlocking knob (2). This means that the curb climber can be quickly removed and refitted.



1. Press the unlocking knobs and pull the quick release axles (1) out of the mountings.
2. Remove the curb climber from the mountings.

8.5.2 Removing backrest frame cross strut

- 1.

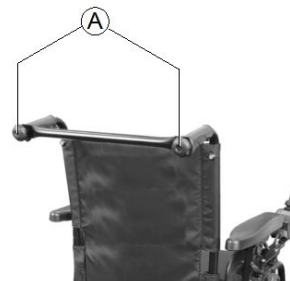

Loosen the knobs on both sides (A) of the cross strut.

- 2.



Unhook the cross strut at the right-hand knob.

8.5.3 Folding the wheelchair

1.



Remove seat cushion (1).

2. If the armrests are set to a smaller width than the seat frame, you need to remove them. Otherwise, the armrests will collide with the seat frame when folding it. Refer to *6.5.1 Removing the standard armrest in order to side transfer, page 39*.

3.



There are two locks (1) located right and left under the seat which need to be opened in order to fold the chair together.



Press locking lever (1) inwards and downwards.

4.



Open lock inwards.

5. Repeat steps two and three on the other side.

6.



Tilt the wheelchair slightly to the side and press it together.



8.6 Reassembling the wheelchair

Reassembly of the wheelchair takes place in reverse order to disassembly. Proceed as follows:

1. Unfold the wheelchair. Refer to *8.5.3 Folding the wheelchair, page 57*.
2. Install the backrest frame cross strut. Refer to *8.5.2 Removing backrest frame cross strut, page 56*.
3. Install the batteries. Refer to *7.2.10 Removing the batteries, page 48*.
4. Install the curb climber, if fitted.. Refer to *8.5.1 Removing the curb climber, page 56*.
5. Install the legrests. Refer to the corresponding legrest chapters.

9 Maintenance

9.1 Maintenance introduction

The term “Maintenance“ means any task performed to ensure that a medical device is in good working order and ready for use as intended. Maintenance encompasses different areas, such as everyday care and cleaning, inspection checks, repair tasks and refurbishment.



Have your vehicle checked once a year by an authorized Invacare provider in order to maintain its driving safety and roadworthiness.

9.2 Cleaning the mobility device

When cleaning the mobility device, pay attention to the following points:

- Only use a damp cloth and gentle detergent.
- Do not use any abrasive or scouring agents.
- Do not subject the electronic components to any direct contact with water.

9.3.1 Before each use of the mobility device

Item	Inspection check	If inspection is not passed
Signal horn	Check for correct function.	Contact your provider.
Lighting system	Check that all lights, such as turn indicators, head lamps and tail lights, are functioning correctly.	Contact your provider.
Batteries	Make sure the batteries are charged. See the user manual provided with your remote for a description of the Battery Charge Indicator.	Charge the batteries (refer to 7.2.3 <i>How to charge the batteries, page 45</i>).

- Do not use any high-pressure cleaning devices.

Disinfection

Spray or wipe disinfection using a tested and recognised product is permitted. A list of the current permitted disinfectants is available from the Robert Koch Institute at <http://www.rki.de>.

9.3 Inspection checks

The following table lists inspection checks that should be performed by the user and their intervals. If the mobility device fails to pass one of the inspection checks, refer to the chapter indicated or contact your authorized Invacare provider. A more comprehensive list of inspection checks and instructions for maintenance work can be found in the service manual for this device, which can be obtained from Invacare. That manual, however, is intended to be used by trained and authorized service technicians, and describes tasks which are not intended to be performed by the user.

9.3.2 Weekly

Item	Inspection check	If inspection is not passed
Armrests/side parts	Check that armrests are firmly attached in their holders and do not wobble.	Tighten the screw or clamping lever that holds the armrest (see chapter 5.2 <i>Adjustment possibility for remote</i> , page 26). Contact your provider.
Tires (pneumatic)	Check that the tires are undamaged.	Contact your provider.
	Check that the tires are inflated to the correct pressure.	Inflate the tire to the correct pressure (see chapter 9.4 <i>Wheels and tires</i> , page 61 and 11 <i>Technical Data</i> , page 65).
Tires (puncture-proof)	Check that the tires are undamaged.	Contact your provider.
Antitippers	Check that antitippers are firmly attached and do not wobble. Check that the spring clips of the antitippers are in good order and secure the antitippers correctly.	Contact your provider.

9.3.3 Monthly

Item	Inspection check	If inspection is not passed
All upholstered parts	Check for damage and wear.	Contact your provider.
Manually angle adjustable backrest	Is the ratchet mechanism of the angle adjustment undamaged and in good working order?	Contact your provider.
	Do the different adjustment functions work without any problem?	Contact your provider.

Item	Inspection check	If inspection is not passed
Removable legrests	Check whether the legrests can be fixed securely and whether the loosening mechanism is properly operable.	Contact your provider.
	Check that all adjustment options function properly.	Contact your provider.
Casters	Check that casters rotate and swivel freely.	Contact your provider.
Drive wheels	Check that the drive wheels rotate without wobbling. It is easiest to have someone stand behind the mobility device and observe the drive wheels as you drive away from them to do this.	Contact your provider.
Electronics and connectors	Check all cables for damage and all connecting plugs for snug fit.	Contact your provider.

9.4 Wheels and tires

Dealing with wheel damages

In case of having a damaged wheel, contact your provider. Because of safety reasons do not have the wheel repaired by yourself or by not authorized persons.

Dealing with pneumatic tires

- 
Risk of damage to tire and rim
 Never drive with too low tire pressure, this could result in damage to tire.
 If tire pressure is exceeded rim could be damaged.
 – Inflate tires to recommended pressure.

 Use tire gauge to check pressure.

Check weekly that the tires are inflated to the correct pressure, see chapter 9.3 *Inspection checks*, page 59.

For recommended tire pressure see inscription on tire/rim or contact Invacare. Compare table below for conversion.

psi	bar
22	1.5
23	1.6
25	1.7
26	1.8
28	1.9
29	2.0
30	2.1

psi	bar
32	2.2
33	2.3
35	2.4
36	2.5
38	2.6
39	2.7
41	2.8
44	3.0

9.5 Short-term storage

In case a serious fault is detected, a number of safety mechanisms are built into your mobility device and will protect it. The power module prevents your mobility device from driving.

When the mobility device is in such a condition and while waiting for repair:

1. Switch off power.
2. Disconnect the batteries.
Depending on the mobility device model, you can either remove the battery packs or disconnect the batteries from the power module. Refer to the corresponding chapter about disconnecting the batteries.
3. Contact your provider.

9.6 Long-term storage

In case your mobility device is not used for a longer period of time, you need to prepare it for storage to ensure a longer life for your mobility device and batteries.

Storing mobility device and batteries

- We recommend to store the mobility device at a temperature of 15° C, avoid hot and cold extremes when storing to ensure a long service life of the product and batteries.
- The components are tested and approved for greater temperature ranges as detailed below:
 - Allowable temperature range to store the mobility device is -40° up to 65° C.
 - Allowable temperature range to store batteries is -25° up to 65° C.
- Even not being used, batteries discharge themselves. Best practice is to disconnect the battery supply from the power module if storing the mobility device longer than two weeks. Depending on the mobility device model, you can either remove the battery packs or disconnect the batteries from the power module. Refer to the corresponding chapter about disconnecting the batteries. If in doubt which cable to disconnect, contact your provider.
- Batteries should always be fully charged before storing.
- If storing the mobility device longer than four weeks, check the batteries once a month and recharge as needed (before gauge reads half full) to avoid damage.
- Store in a dry, well-ventilated environment protected from outer influences.
- Slightly overinflate pneumatic tires.

- Position the mobility device on flooring that is not discolored by contact with tire rubber.

Preparing mobility device for use

- Re-connect the battery supply to the power module.
- The batteries must be charged before use.
- Have the mobility device checked by an authorized Invacare provider.

10 After Use

10.1 Reconditioning

The product is suitable for reuse. To recondition the product for a new user, carry out the following actions:

- Cleaning and disinfection. Refer to *9 Maintenance, page 59*.
- Inspection according to service plan. Consult service instructions, available from Invacare.
- Adaptation to the user. Refer to *5 Setup, page 25*.

10.2 Disposal

- The equipment wrapping is potentially recyclable.
- The metal parts are used for scrap metal recycling.
- The plastic parts are used for plastic recycling.
- Electric components and printed circuit boards are disposed of as electronic scrap.
- Exhausted or damaged batteries can be returned to your medical equipment supplier or Invacare.
- Disposal must be carried out in accordance with the respective national legal provisions.
- Ask your city or district council for details of the local waste management companies.

11 Technical Data

11.1 Technical specifications

The technical information provided hereafter applies to a standard configuration or represents maximum achievable values. These can change if accessories are added. The precise changes to these values are detailed in the sections for the respective accessories.

 Note that in some cases the measured values may vary up to ± 10 mm.

Permissible operating and storage conditions	
Temperature range for operation according to ISO 7176-9:	<ul style="list-style-type: none"> -25° ... +50 °C
Recommended storage temperature:	<ul style="list-style-type: none"> 15 °C
Temperature range for storage according to ISO 7176-9:	<ul style="list-style-type: none"> -25° ... +65 °C with batteries -40° ... +65 °C without batteries

Electrical system	
Motors	<ul style="list-style-type: none"> 2 x 110 W (3 km/h) 2 x 180 W (6 km/h)
Batteries	<ul style="list-style-type: none"> 2 x 12 V/30 Ah, leakproof/gel 2 x 12 V/40 Ah, leakproof/gel 2 x 12 V/48.2 Ah, leakproof/gel
Main fuse	<ul style="list-style-type: none"> 2 x 35 A
Degree of protection	IPX4 ¹

Charging device	
Output current	<ul style="list-style-type: none"> • 8 A \pm 8 %
Output voltage	<ul style="list-style-type: none"> • 24 V nominal (12 cells)
Drive wheel tires	
Tire type	<ul style="list-style-type: none"> • 330 mm (12½" x 2¼") pneumatic or puncture-proof
Tire pressure	<p>The recommended maximum tire pressure in bar or kpa is marked on the side wall of the tire or the rim. If more than one value is listed, the lower one in the corresponding units applies.</p> <p>(Tolerance = -0.3 bar, 1 bar = 100 kpa)</p>
Caster tires	
Tire type	<ul style="list-style-type: none"> • 200 x 50 mm pneumatic or puncture-proof
Tire pressure	<p>The recommended maximum tire pressure in bar or kpa is marked on the side wall of the tire or the rim. If more than one value is listed, the lower one in the corresponding units applies.</p> <p>(Tolerance = -0.3 bar, 1 bar = 100 kpa)</p>
Driving characteristics	
Speed	<ul style="list-style-type: none"> • 3 km/h • 6 km/h
Min. braking distance	<ul style="list-style-type: none"> • 400 mm (3 km/h) • 1000 mm (6 km/h)
Rated slope ²	<ul style="list-style-type: none"> • 6° (10.5 %) according to manufacturer's specifications with 120 kg payload, 4° seat angle, 20° backrest angle

Driving characteristics	
Max. climbable obstacle height	<ul style="list-style-type: none"> • 60 mm (without curb climber) • 100 mm (with curb climber)
Turning diameter	<ul style="list-style-type: none"> • 1800 mm
Pivot width	<ul style="list-style-type: none"> • 1000 mm
Drive range in accordance with ISO 7176-4 ³	<ul style="list-style-type: none"> • 20 km (30 Ah batteries) • 25 km (40 Ah batteries) • 27 km (48.2 Ah batteries)

Dimensions according to ISO 7176-15	
Total height	<ul style="list-style-type: none"> • 930 mm
Drive unit width	<ul style="list-style-type: none"> • 530/570/610/625/680 mm
Total length (incl. standard legrests)	<ul style="list-style-type: none"> • 1095 mm
Stowage length	<ul style="list-style-type: none"> • 830 mm
Stowage width	<ul style="list-style-type: none"> • 435 mm
Stowage height	<ul style="list-style-type: none"> • 930 mm
Ground clearance	<ul style="list-style-type: none"> • 90 mm
Seat height ⁴	<ul style="list-style-type: none"> • 510 mm
Seat width (armrest adjustment range in brackets)	<ul style="list-style-type: none"> • 350 mm (350 - 430 mm⁵) • 400 mm (400 - 480 mm⁵) • 475 mm (475 - 550 mm⁵) • 500 mm (500 - 580 mm⁵)
Seat depth	<ul style="list-style-type: none"> • 400/450/500/535 mm
Backrest height ⁴	<ul style="list-style-type: none"> • 435/450/530 mm

Dimensions according to ISO 7176-15	
Seat cushion thickness	<ul style="list-style-type: none"> • 50 mm
Backrest angle	<ul style="list-style-type: none"> • 93° ... 125° (gas spring) • 103° (fixed) • 93°, 103°, 113°, 123° (manual)
Armrest height (standard armrest)	<ul style="list-style-type: none"> • 250 ... 310 mm
Armrest depth ⁶	<ul style="list-style-type: none"> • 375 mm
Horizontal location of axle ⁷	<ul style="list-style-type: none"> • 65 mm
Legrest length	<ul style="list-style-type: none"> • 350 ... 460 mm
Seat angle	<ul style="list-style-type: none"> • 1.85°

Weight⁸	Seat width 400 mm	Seat width 450 mm
Curb weight	<ul style="list-style-type: none"> • 64 kg (30 Ah batteries) • 72 kg (40 Ah batteries) 	<ul style="list-style-type: none"> • 78 kg (48.2 Ah batteries)

Component weights	
Batteries 30 Ah	<ul style="list-style-type: none"> • approx. 11 kg per battery
Batteries 40 Ah	<ul style="list-style-type: none"> • approx. 15 kg per battery
Batteries 48.2 Ah	<ul style="list-style-type: none"> • approx. 15 kg per battery

Payload	
Max. payload	<ul style="list-style-type: none"> • 120 kg

Axle loads	
Max. front axle load	<ul style="list-style-type: none"> • 96 kg
Max. rear axle load	<ul style="list-style-type: none"> • 123 kg

- 1 IPX4 classification means that the electrical system is protected against spray water.
- 2 Static stability according to ISO 7176-1 = 9° (15.8 %)
Dynamic stability according to ISO 7176-2 = 6° (10.5 %)
- 3 Note: The drive range of a mobility device is strongly influenced by external factors, such as the speed setting of the wheelchair, the charging state of the batteries, surrounding temperature, local topography, road surface characteristics, tire pressure, weight of user, drive style and use of batteries for lighting, servos etc.
The specified values are theoretical maximum achievable values measured according to ISO 7176-4.
- 4 Measured without seat cushion
- 5 Width adjustable for side panel adjustment
- 6 Distance between backrest reference plane and most forward part of armrest assembly
- 7 Horizontal distance of wheel axle from intersection of loaded seat and backrest reference planes
- 8 The actual curb weight depends on the fittings your mobility device has been supplied with. Every Invacare mobility device is weighed when leaving the works. Refer to the nameplate for the curb weight (including batteries) measured.

12 Service

12.1 Inspections performed

It is confirmed by stamp and signature that all jobs listed in the inspection schedule of the service and repair instructions have been properly performed. The list of the inspection jobs to be performed can be found in the service manual which is available through Invacare.

Delivery Inspection	1st Annual Inspection
Stamp of authorized provider / Date / Signature	Stamp of authorized provider / Date / Signature
2nd Annual Inspection	3rd Annual Inspection

Stamp of authorized provider / Date / Signature	Stamp of authorized provider / Date / Signature
4th Annual Inspection	5th Annual Inspection
Stamp of authorized provider / Date / Signature	Stamp of authorized provider / Date / Signature

Invacare Sales Companies

Australia:

Invacare Australia PTY. Ltd.
1 Lenton Place, North Rocks NSW
2151

Australia

Phone: 1800 460 460

Fax: 1800 814 367

orders@invacare.com.au

www.invacare.com.au

United Kingdom:

Invacare Limited

Pencoed Technology Park, Pencoed

Bridgend CF35 5AQ

Tel: (44) (0) 1656 776 222

Fax: (44) (0) 1656 776 220

uk@invacare.com

www.invacare.co.uk

Canada:

Invacare Canada LP
570 Matheson Blvd E. Unit 8
Mississauga Ontario

L4Z 4G4, Canada

Phone: (905) 890 8300

Fax: (905) 501 4336

Eastern Europe, Middle East & CIS:

Invacare EU Export

Kleiststraße 49

D-32457 Porta Westfalica / Germany

Tel: (49) (0)57 31 754 540

Fax: (49) (0)57 31 754 541

webinfo-eu-export@invacare.com

www.invacare-eu-export.com

Ireland:

Invacare Ireland Ltd,
Unit 5 Seatown Business Campus
Seatown Road, Swords, County Dublin

Tel : (353) 1 810 7084

Fax: (353) 1 810 7085

ireland@invacare.com

www.invacare.ie

New Zealand:

Invacare New Zealand Ltd
4 Westfield Place, Mt Wellington 1060
New Zealand

Phone: 0800 468 222

Fax: 0800 807 788

sales@invacare.co.nz

www.invacare.co.nz



Manufacturer:

Invacare Deutschland GmbH

Kleiststraße 49

D-32457 Porta Westfalica

Germany

1513283-0 2017-07-18



Making Life's Experiences Possible®



Yes, you can.®