

# FADER

## USER GUIDE





# Welcome to the world of TRNDlabs products!

TRNDlabs products are design focused electronics, engineered to combine ultimate performance and aesthetics.

## Learn how to fly!

TRNDlabs Drone Academy is a video platform where you can get your drone up and running in minutes!

[www.trndlabs.academy](http://www.trndlabs.academy)

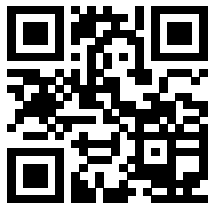

DRONE

**ACADEMY**

# Table of Contents

	<b>6</b>	<b>Parts Identification</b>
Drone Functions	<b>7</b>	<b>7</b> <b>Functions</b>
Controller Functions	<b>7</b>	
<b>Setup</b>	<b>8</b>	<b>8</b> <b>Charging FADER</b>
	<b>9</b>	<b>9</b> <b>Controller Battery Installation</b>
	<b>9</b>	<b>9</b> <b>Mobile Phone Holder Preparation</b>
	<b>10</b>	<b>10</b> <b>Pairing</b>
Take-Off & Land	<b>11</b>	<b>11</b> <b>Piloting</b>
Flight Controls	<b>12</b>	
<b>Setup App</b>	<b>14</b>	<b>14</b> <b>App Installation</b>
	<b>15</b>	<b>15</b> <b>Connecting</b>
	<b>15</b>	<b>15</b> <b>App Functions</b>
	<b>16</b>	<b>16</b> <b>Back to Home</b>
	<b>16</b>	<b>16</b> <b>Show/Hide Buttons</b>
Taking a Photo	<b>17</b>	<b>17</b> <b>Photo &amp; Video</b>
Recording a Video	<b>17</b>	
Playing Back Videos/ Viewing Photos	<b>18</b>	
Saving & Deleting Photos/Videos	<b>18</b>	
SD Card	<b>19</b>	
<b>VR &amp; Preview Mode</b>	<b>20</b>	<b>20</b> <b>Switching VR Mode ON/OFF</b>
	<b>20</b>	<b>20</b> <b>720p Preview Mode</b>

Tips & Tricks **21** **21** Sensitivity Control

**22** Advanced Flight: Performing  
360° Flips

**25** Switching Modes

Direction Trim **26** **26** Troubleshooting

Rotation Trim **26**

Calibration **27**

Rotor Protector Installation **27**

Replacing Rotor Blades **28**

FAQ **29**

Safety Precautions **30** **31** Additional Safety Precautions

**32** Battery Safety Instructions

**32** FCC Compliance Information  
(USA only)

Limited 1-Year Warranty **33** **33** Warranty

Repair/Replace Product **33**

Preparation For Shipping  
Your Product **33**

# Parts Identification



USB  
Charging  
Cable

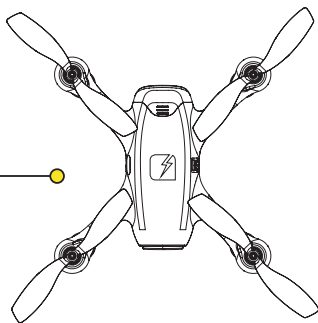

FADER

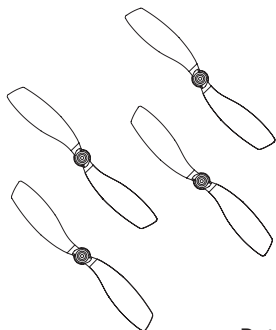

Replacement Rotor Blades (4x)

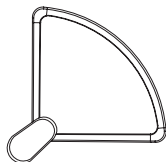

Rotor Protectors (4x)

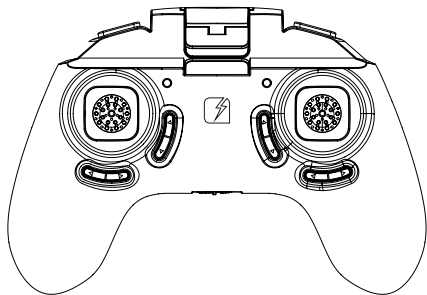

Controller

Screwdriver



# Functions

## Drone Functions

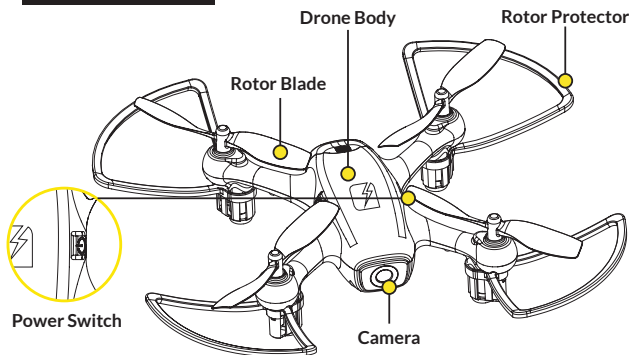

## Controller Functions

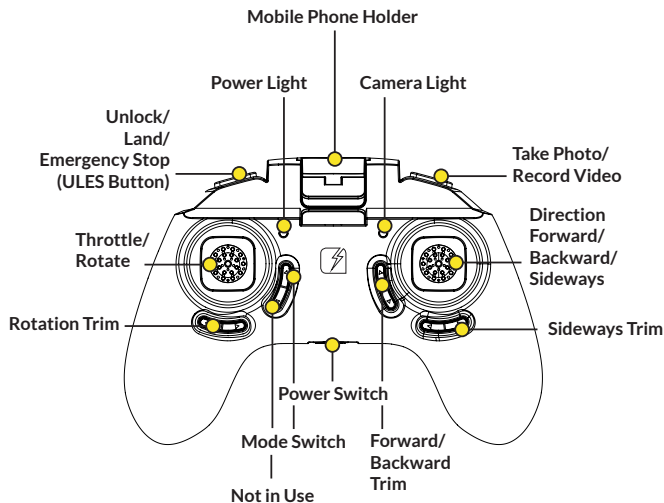

# Setup

## Charging FADER



Slide the battery out of the drone by pulling it gently.

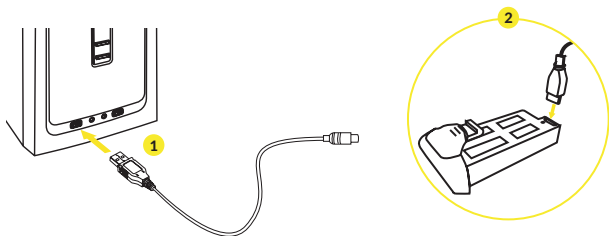

Connect the Micro USB Charging Cable to a USB port **1** and the battery of the drone. **2** A LED light on the battery will indicate it is charging. When the battery is fully charged, the LED light on the battery turns off. It takes about 30 minutes to recharge a discharged battery.



Make sure you only charge the rechargeable battery with the supplied USB Charging Cable. If you try to charge the rechargeable battery with a different battery charger, this might cause serious damage.



## Controller Battery Installation

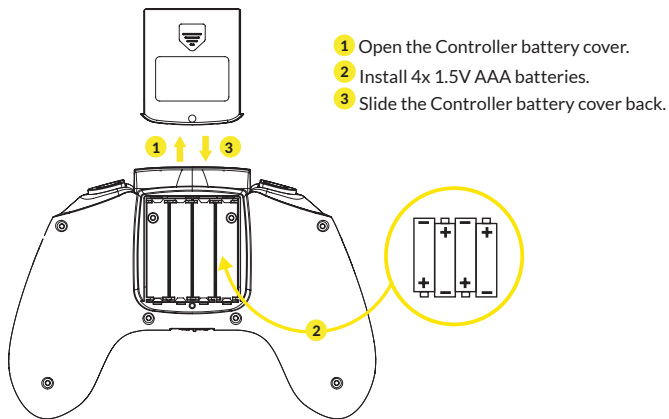

## Mobile Phone Holder Preparation

Slide the Mobile Phone Holder from closed position to open position. You can now place a mobile phone.

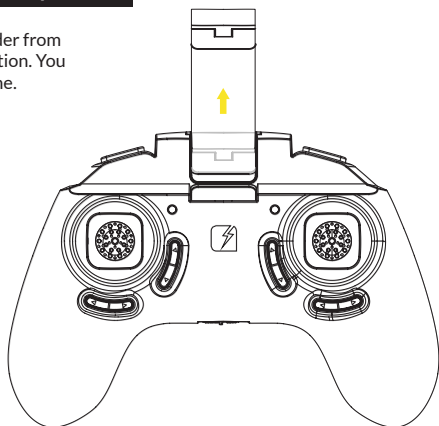

# Pairing

Place the drone on a flat and level surface.

- 1 Slide the Power Switch to turn on the Controller. The Red Indicator Light on the Controller starts flashing slowly.
- 2 Press the Power Switch to switch the drone ON. The LED lights of the drone starts flashing fast.
- 3 Push the Throttle/Rotate stick to the full up position, then to the full down position. The Red Indicator Light on the controller turns off and the LED lights on the drone turn solid.
- 4 The drone is ready to fly.

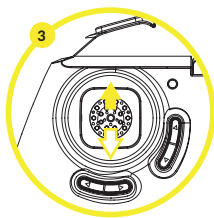
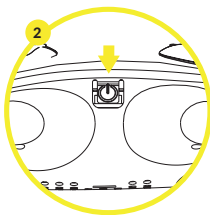
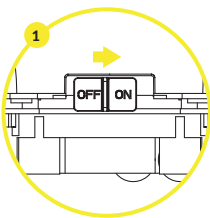

# Piloting

## Take-Off & Land

- 1 Pushing the ULES Button will cause the rotors of the drone to spin without taking off.
- 2 To take off the drone push the Throttle/Rotate button. The drone will hover at approximately 1.5 meter.
- 3 When flying, push the ULES Button again to land the drone.
- 4 In case of an emergency, press and hold the ULES Button for 3 seconds. This will stop the rotors and cause the drone to fall out of the sky.

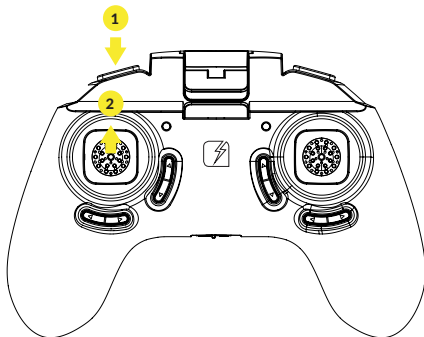

## Throttle Control

To fly higher, push the Throttle/Rotate stick cautiously forward. To fly lower, push the Throttle/Rotate stick cautiously backward.

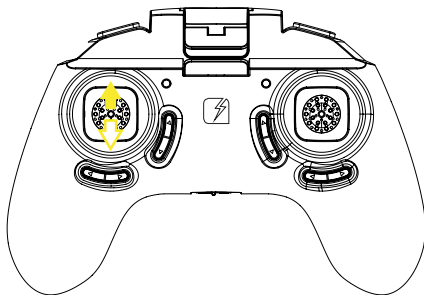

## Flight Controls

### Direction Control

To fly the drone forward or backward, push the Direction stick cautiously forward or backward.

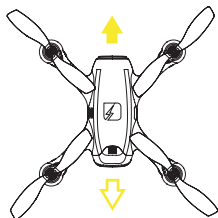
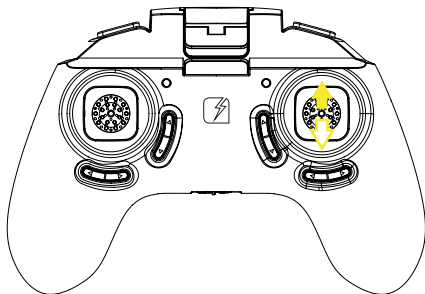

To fly the drone to the left or the right, push the Direction stick cautiously to the left or the right.

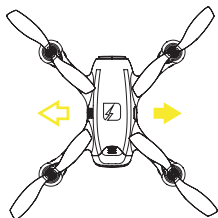
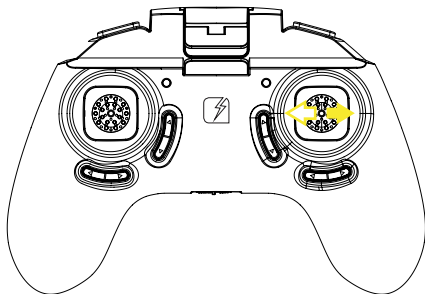

## Rotation Control

To make the drone circle to the left or the right, push the Throttle/Rotate stick cautiously to the left or right.

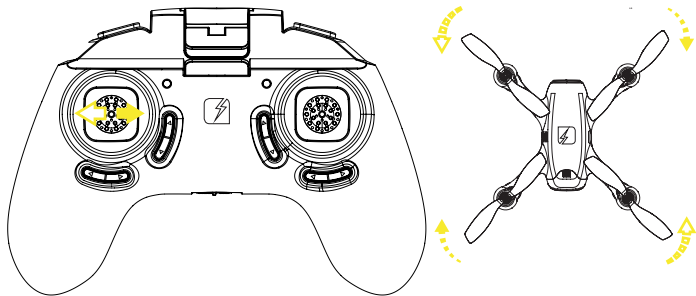

# Setup App

## App Installation

The App is suitable for mobile phones with iOS or Android. The App can be downloaded from the App Store or Google Play.

Scan the QR code to download the App: TRNDlabs FADER



For mobile phones with iOS, search TRNDlabs FADER in the App Store.



For mobile phones with Android, search TRNDlabs FADER in Google Play.

## Connecting

- 1 Pair the drone and controller, see chapter "Pairing" (page 10)
- 2 Enter the settings of your mobile phone and turn on the WiFi.
- 3 Select "FADER-XXXX" in the list of networks.
- 4 Go back and select the FADER App.
- 5 Tap on the FLY button to enter the Live Video interface.

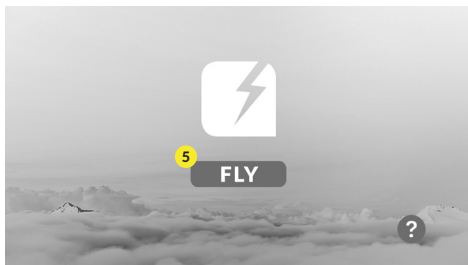

## App Functions

- |                      |                                       |
|----------------------|---------------------------------------|
| 1 Back to Home       | 5 VR Mode                             |
| 2 Take a Photo       | 6 720p preview                        |
| 3 Record a Video     | 7 Help                                |
| 4 View Photos/Videos | 8 Tap on screen to hide/show buttons. |

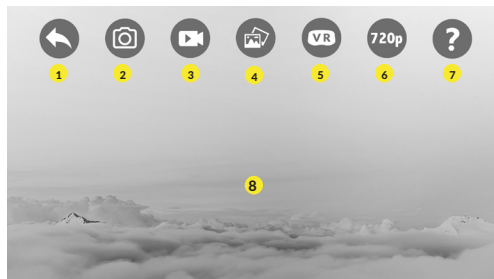

## Back to Home

Tap the back icon to return to the home screen.

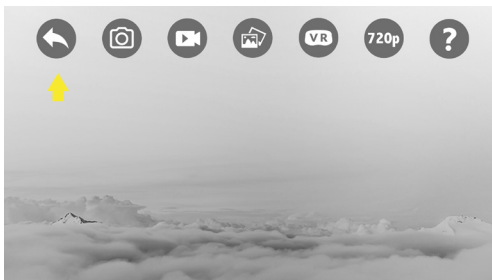

## Show/Hide Buttons

Tap anywhere on the screen to hide the buttons. Tap again to bring up the buttons again.

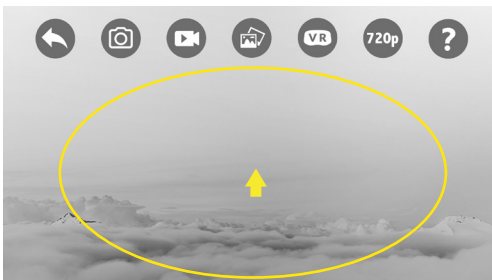



# Photo & Video

## Taking a Photo

Tap the photo icon to take a photo. The icon will flash yellow momentarily, to notify a picture is taken. You can also take a picture with the Photo Button on the controller. Press the Photo Button once to take a photo.

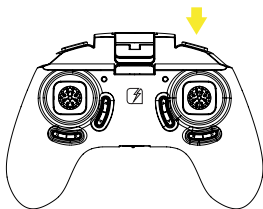
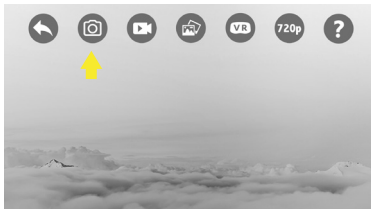

## Recording a Video

Tap the video icon to record a video. The icon will turn yellow when it's recording. Tap the icon again to stop recording, the icon will turn grey again. You can also record a video by pressing the Video Button on the controller for 3 seconds. Press the button again for 3 seconds to stop recording.

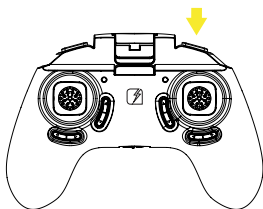
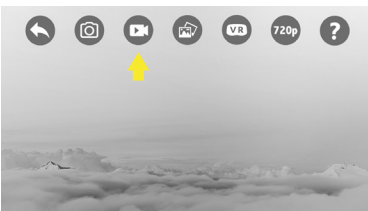

## Playing Back Videos/Viewing Photos

Tap the gallery icon to view photo and video galleries.

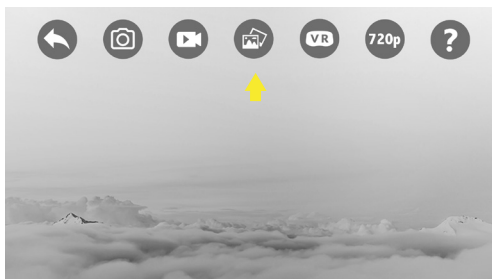

## Saving & Deleting Photos/Videos

In the photo or video gallery tap the selection icon **1** to enter selection mode.

Now select the file(s) you want to save to your phone's gallery **2** or delete entirely **3**. Files that are saved show up in your phone's gallery or camera roll.

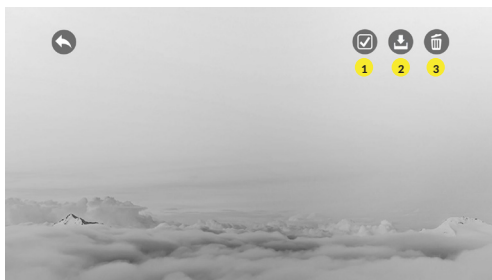

## SD Card

The SD card is mounted at the bottom of FADER. You can remove the SD card and connect it to your computer via the microSD Card USB Reader. You will find the video and photo files on the SD card. Make sure the drone is turned off before extracting the SD card from the drone.

When reinstalling the SD card, make sure the drone is turned off and the metal contacts on the SD card are facing in the right direction when inserting the SD card. Now you can safely turn on FADER and all new photo and video files will be saved to the installed SD card.

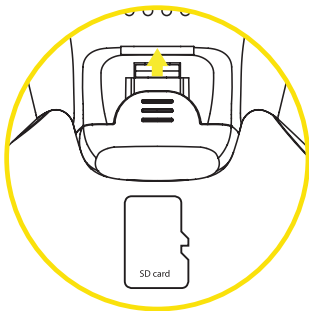

# VR & Preview Mode

## Switching VR Mode ON/OFF

Tap the VR Mode button to activate VR Mode. The button will turn yellow and the live feed from the drone will be visible as split screen. Press the button again to switch back to normal view.

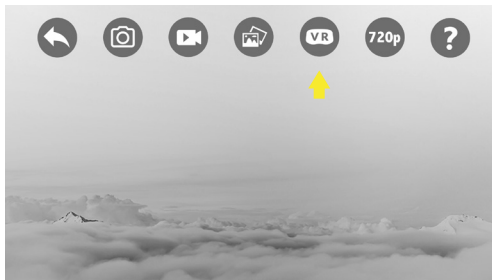

## 720p Preview Mode

Tap the 720p Button to switch to 720p preview mode. The button turns yellow to indicate the Preview Mode is switched ON. Tap the button again to switch the 720p Preview Mode OFF. The button will turn grey again to indicate the Preview Mode is turned OFF. By default the 720P preview mode is ON.

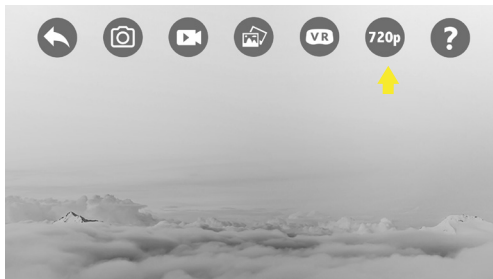

# Tips & Tricks

## Sensitivity Control

The drone has three sensitivity settings: Low, Medium and High. A higher sensitivity makes the drone faster and more responsive.

### Controller Sensitivity Control

Press the Throttle/Rotate stick to change the sensitivity:

- 1 When the Controller emits 1 tone = Low sensitivity mode.
- 2 When the Controller emits 2 tones = Medium sensitivity mode.
- 3 When the Controller emits 3 tones = High sensitivity mode.

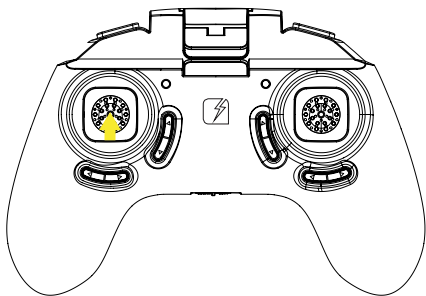

## Advanced Flight: Performing 360° Flips

- 1 Press the Direction stick to enter flip mode. The Controller will start to beep.

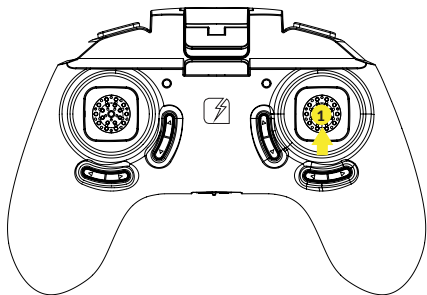

- 2 Push the Direction stick forward, backward, right or left to perform flips. The drone carries out the flip in the respective direction.

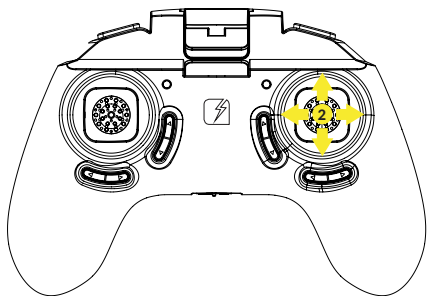

WARNING

Do not attempt these stunts until you are able to fly confidently. Choose an area that will provide a soft landing (carpet or grass) and maintain an altitude of at least 10 feet/3 meter to allow room to recover control as you practice flipping the drone.

### Left Side 360° Flip

Press the Direction stick and push it to the left.

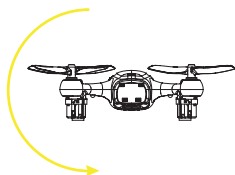
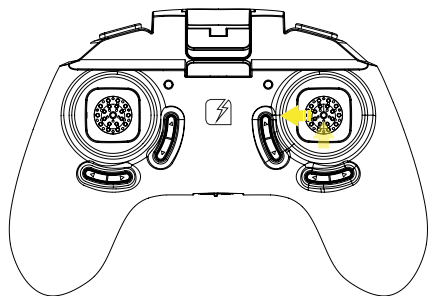

### Right Side 360° Flip

Press the Direction stick and push it to the right.

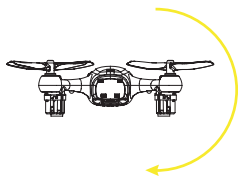
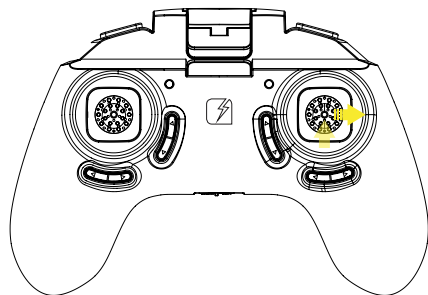

## Forward 360° Flip

Press the Direction stick and push it forward.

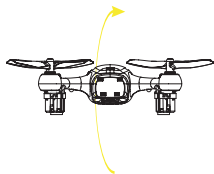
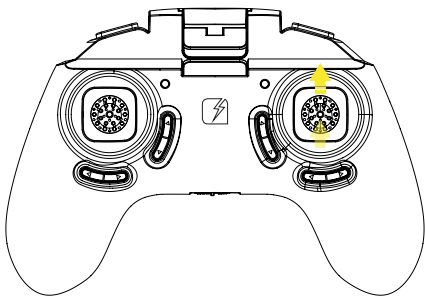

## Backward 360° Flip

Press the Direction stick and push it backward.

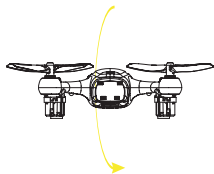
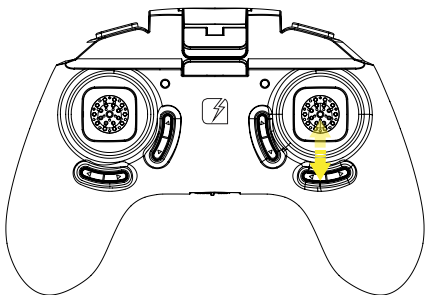



## Switching Modes

The drone can be switched from Normal Mode **A** to Headless Mode **B**. Headless Mode does not require the pilot to differentiate the front (head) position of the drone, but simply use the Direction Stick for the drone to respond correctly to the given input relative to the position of the controller.

To enter Headless Mode, press button **1**. The controller will emit a beeping sound to confirm the drone is now in headless mode. Press button **1** again to exit Headless Mode. The controller emits a beep tone again to confirm return to Normal Mode.

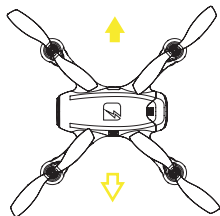
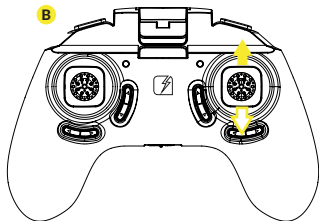
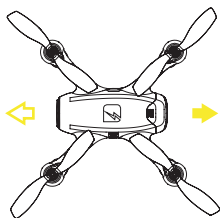
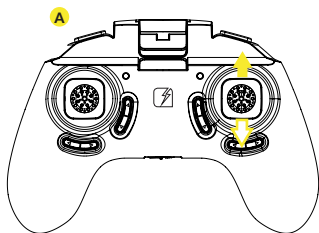
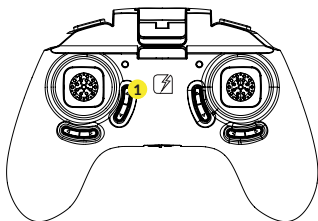

# Troubleshooting

## Direction Trim

When hovering, if the drone flies forward or backward without moving the Direction stick, proceed as follows:

- 1 If the drone moves on its own forward, tap the Backward Trim arrow in steps.
- 2 If the drone moves on its own backward, tap the Forward Trim arrow in steps.

When hovering, if the drone flies to the left or right without moving the Direction stick, proceed as follows:

- 3 If the drone moves on its own sideways to the left, tap the Right Trim arrow in steps.
- 4 If the drone moves on its own sideways to the right, tap the Left Trim arrow in steps.

## Rotation Trim

When hovering, if the drone rotates to the left or right without you moving the Throttle/Rotate stick, proceed as follows:

- 5 If the drone rotates on its own to the left, tap the right Rotate Trim arrow in steps.
- 6 If the drone rotates on its own to the right, tap the left Rotate Trim arrow in steps.

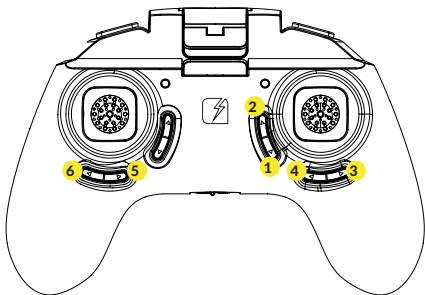

## Calibration

The drone needs to be calibrated if it flies unstable.

Place the drone on a flat and level surface. Now, at the same time, push both the left and right joystick to the lower left corners and hold for 2 to 3 seconds. The LED lights on the drone will start blinking rapidly, indicating the drone is calibrating. After 2 to 3 seconds the LED lights will return back to normal, indicating the calibration was successful.

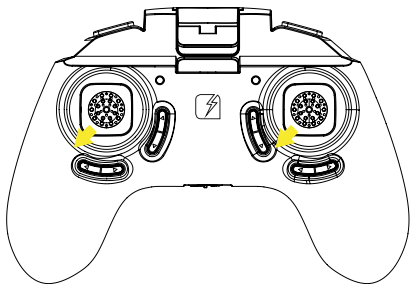

## Rotor Protector Installation

Gently slide the Rotor Protectors from below onto the landing feet of the drone.

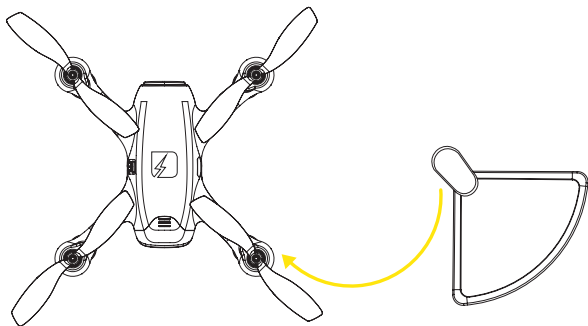

## Replacing Rotor Blades

To replace a rotor blade, follow the steps below:

- 1 Put the Screwdriver onto the screw in the top of the rotor blade. Gently turn the Screw Driver counter clockwise.
- 2 Remove the Rotor Blade from the drone.
- 3 Press the new rotor blade onto the motor axis and fasten it using the screwdriver.

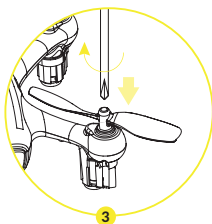
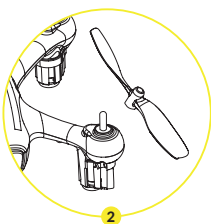
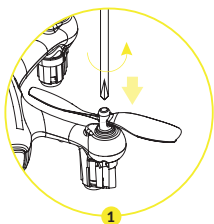

Each rotor blade is marked with a "A" or "B". Be sure to note the marking and the tilt angle of the rotor blades. When replacing the rotor blades, please install the right type of blade on the correct position on the drone.

Front left: marking "A"  
Front right: marking "B"  
Rear left: marking "B"  
Rear right: marking "A"

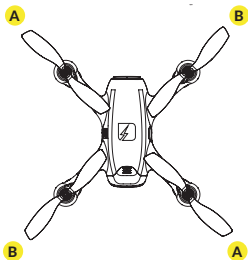

## FAQ



**Problem:** Controller does not work.



**Cause:** The batteries have been incorrectly inserted.  
**Solution:** Check if the batteries have been correctly inserted.

**Cause:** The batteries do not have enough power.  
**Solution:** Insert new batteries.



**Problem:** The drone cannot be controlled with the controller.



**Cause:** The controller is possibly not correctly paired with the drone.  
**Solution:** Carry out the pairing procedure as described in "Pairing" (page 10).



**Problem:** The Drone does not lift.



**Cause:** The battery power is not sufficient.  
**Solution:** Charge the battery as described in "Charging FADER" (page 8).



**Problem:** During flight, the Drone loses speed and height without any obvious reason.



**Cause:** The battery is too weak.  
**Solution:** Charge the battery as described in "Charging FADER" (page 8).



**Problem:** The drone only flies in a circle or flips over before taking off.



**Cause:** Rotor blades incorrectly mounted or damaged.  
**Solution:** Fit rotor blades/replace rotor blades as described in "Replacing Rotor Blades" (page 27).



**Problem:** Unable to find photos and videos in App Gallery.



**Solution:** Photos and videos taken with the App are stored on the mobile device and on the SD card of the drone. Photos and videos taken with the controller are stored on the SD card of the drone only.

# Safety Precautions

Carefully follow the instructions below. Make sure you fly the drone safely, and you mind the warnings. The drone is not intended for use by children under fourteen years old, unless directly supervised by a competent adult at all times.

Always ensure the safety of yourself, others and the drone. The drone has rotating blades that move at high speed and might cause damage or danger. Pilots are responsible for any actions that result in damage or injury due to improper operation of the drone.

Make sure you use the drone in a proper environment. Choose an adequate flying space without obstacles.

Keep your hands, face, hair or loose clothes away from the rotating blades. Hair getting into the rotor might cause serious damage of the drone.

Never lose sight of the drone. If the drone flies out of your field of view, immediately stop operating it.

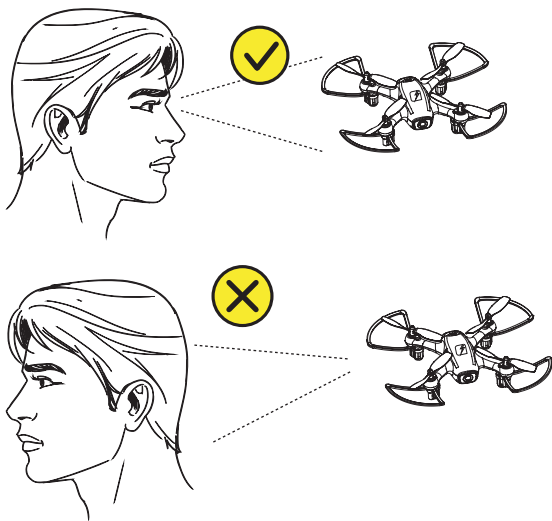

Do not fly near buildings. Do not fly over stations, railways or highways. Do not fly near trees, or crowds of people. Do not fly in rain, snow, fog, storm, wind or in unclear weather conditions at night.

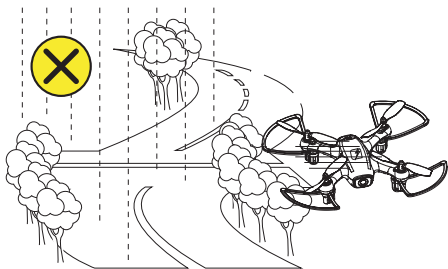

Do not approach or film people without their consent. Be mindful of privacy.

Avoid ceiling fans, hanging light fixtures, heating or air conditioning.

### Additional Safety Precautions

- This drone has small parts that may pose a choking hazard. Keep all small parts and electrical devices out of the reach of children and animals. Pets can become excited by radio-controlled drones.
- The drone is controlled by radio, therefore it is subject to radio interference from many sources that are beyond your control. Radio interference can cause momentary loss of radio control. Always allow a safety margin in all directions around the drone in order to prevent collisions.
- The controller and the charger are specially designed to charge this model. Never use other charging equipments.
- Regularly examine the drone and controller for any damage to the plugs, enclosure, rotor blades, battery covers and other parts. In the event of any damage, neither the drone nor the controller should be used.
- When cleaning the drone or controller, use a damp cloth and wipe gently. Avoid using chemicals, it can damage the plastic components.

## Battery Safety Instructions

- For the best performance, only use fresh 1.5V Alkaline “AAA” batteries in the controller.
- Never operate the drone with low controller batteries
- The drone automatically switches off if the rotors are unable to rotate. Switch the power to restart the drone.
- When not in use, store the drone in the original packaging with the batteries removed from the controller.
- Always recharge the battery after use in order to prevent it becomes deep discharged. Make sure to allow a pause of about 20 minutes between finishing the flight and recharging the battery.
- Even if the drone is not in regular use, recharge the battery occasionally, suggested at least once every 2-3 months.
- When transporting or temporarily storing the rechargeable battery, the temperature should be between 5-50 C. Do not store the battery or the drone in a car and do not expose it to direct sunlight. In case the battery is overheated it can be damaged or catch fire.
- Do not submerge the drone or the controller in water. This will damage the electronic components and could pose a severe risk to the built-in battery.

## FCC Compliance Information (USA only)

This device complies with part 15 of the FCC Rules. Operation is subject to the following two conditions: (1) This device may not cause harmful interference, and (2) This device must accept any interference received, including interference that may cause undesired operation. Changes or modifications not expressly approved by the party responsible for compliance could void the user's authority to operate the equipment.



# Warranty

## Limited 1-Year Warranty

TRNDlabs warrants to the original consumer that this product is free from any electrical or mechanical defects for a period of one year from the date of purchase. If any such defect is discovered within the warranty period, TRNDlabs will repair or replace the unit free of charge upon receipt of the unit, send it prepaid and insured to us. The warranty covers normal consumer use and does not cover damage that occurs in shipment or failure that results from alterations, accident, misuse, abuse, neglect, wear and tear, in adequate maintenance, commercial use or unreasonable use of the unit. Removal of any parts/components voids all warranties. This warranty does not cover the cost of repairs made or attempted outside by third-party individuals or companies. Any applicable implied warranties, including warranties of merchantability and fitness, are hereby excluded. Some states not allow limitations on the duration of implied warranties and do not allow exclusions of the incidental or consequential damages, so the above limitations and exclusions in these instances may not apply.

## Repair/Replace Product

If your product begins to malfunction or stop working, immediately email us at [hello@trndlabs.com](mailto:hello@trndlabs.com). If it is determined that a return is necessary, our warranty department will issue you an RMA number/form and the address to the nearest return center for shipping the product too. **IMPORTANT NOTICE:** We will reject all returns that are not accompanied by an issued RMA number, so make sure to contact us before attempting to return your product!

## Preparation For Shipping Your Product

Please repack your product in a durable box, preferably in the original carton. Include the RMA form that was issued by us along with your daytime telephone number and email address inside the shipping carton. If your warranty has expired and you want an estimated fee for service, you may do so by simply emailing us and specifying the model and the problem.





The contents of this document are subject to change.  
Download the latest version from  
[www.trndlabs.com](http://www.trndlabs.com).

If you have any questions about this document, please contact TRNDlabs  
by sending a message to [hello@trndlabs.com](mailto:hello@trndlabs.com).

© 2020 TRNDlabs. All rights reserved.



 **TRNDlabs**