

Approval body for construction products
and types of construction

Bautechnisches Prüfamt

An institution established by the Federal and
Laender Governments



European Technical Assessment

ETA-15/0514
of 28 May 2019

English translation prepared by DIBt - Original version in German language

General Part

Technical Assessment Body issuing the
European Technical Assessment:

Deutsches Institut für Bautechnik

Trade name of the construction product

TSM high performance, TSM high performance A4, TSM
high performance HCR

Product family
to which the construction product belongs

Mechanical fasteners for use in concrete

Manufacturer

TOGE Dübel GmbH & Co. KG
Illesheimer Straße 10
90431 Nürnberg
DEUTSCHLAND

Manufacturing plant

TOGE Dübel GmbH & Co. KG

This European Technical Assessment
contains

22 pages including 3 annexes which form an integral part
of this assessment

This European Technical Assessment is
issued in accordance with Regulation (EU)
No 305/2011, on the basis of

EAD 330232-00-0601

This version replaces

ETA-15/0514 issued on 2 December 2016

The European Technical Assessment is issued by the Technical Assessment Body in its official language. Translations of this European Technical Assessment in other languages shall fully correspond to the original issued document and shall be identified as such.

Communication of this European Technical Assessment, including transmission by electronic means, shall be in full. However, partial reproduction may only be made with the written consent of the issuing Technical Assessment Body. Any partial reproduction shall be identified as such.

This European Technical Assessment may be withdrawn by the issuing Technical Assessment Body, in particular pursuant to information by the Commission in accordance with Article 25(3) of Regulation (EU) No 305/2011.

Specific Part

1 Technical description of the product

The TOGE Concrete screw TSM high performance is an anchor in size 6, 8, 10, 12 and 14 mm made of galvanised steel respectively steel with zinc flake coating, made of stainless or high corrosion resistant steel. The anchor is screwed into a predrilled cylindrical drill hole. The special thread of the anchor cuts an internal thread into the member while setting. The anchorage is characterised by mechanical interlock in the special thread.

Product and product description is given in Annex A.

2 Specification of the intended use in accordance with the applicable European Assessment Document

The performances given in Section 3 are only valid if the anchor is used in compliance with the specifications and conditions given in Annex B.

The verifications and assessment methods on which this European Technical Assessment is based lead to the assumption of a working life of the anchor of at least 50 years. The indications given on the working life cannot be interpreted as a guarantee given by the producer, but are to be regarded only as a means for choosing the right products in relation to the expected economically reasonable working life of the works.

3 Performance of the product and references to the methods used for its assessment

3.1 Mechanical resistance and stability (BWR 1)

Essential characteristic	Performance
Characteristic resistance to tension load (static and quasi-static loading)	See Annex C 1 and C 2
Characteristic resistance to shear load (static and quasi-static loading)	See Annex C 1 and C 2
Displacements (static and quasi-static loading)	See Annex C 7
Characteristic resistance and displacements for seismic performance categories C1 and C2	See Annex C 3, C 4, C 5 and C 8

3.2 Safety in case of fire (BWR 2)

Essential characteristic	Performance
Reaction to fire	Class A1
Resistance to fire	See Annex C 6

4 Assessment and verification of constancy of performance (AVCP) system applied, with reference to its legal base

In accordance with European Assessment Document EAD No. 330232-00-0601 the applicable European legal act is: [96/582/EC].

The system to be applied is: 1

5 Technical details necessary for the implementation of the AVCP system, as provided for in the applicable European Assessment Document

Technical details necessary for the implementation of the AVCP system are laid down in the control plan deposited at Deutsches Institut für Bautechnik.

Issued in Berlin on 28 May 2019 by Deutsches Institut für Bautechnik

Dr.-Ing. Lars Eckfeldt
p. p. Head of Department

beglaubigt:
Tempel

Product in installed condition

TOGE concrete screw TSM high performance

- Galvanized carbon steel
- Zinc flakes coated carbon steel

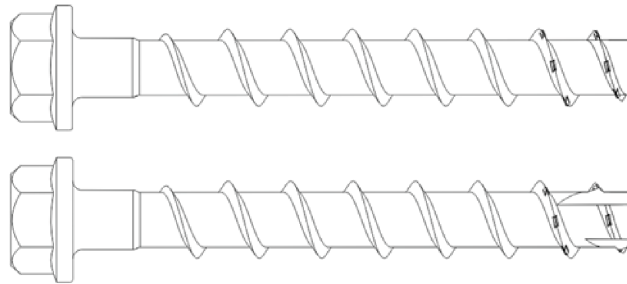

- Stainless steel A4
- Stainless steel HCR

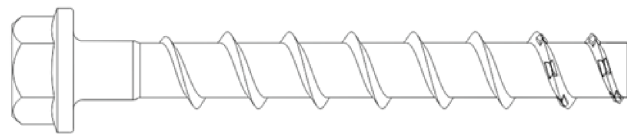

e.g. TOGE concrete screw, zinc flakes coated, with hexagon head and fixture

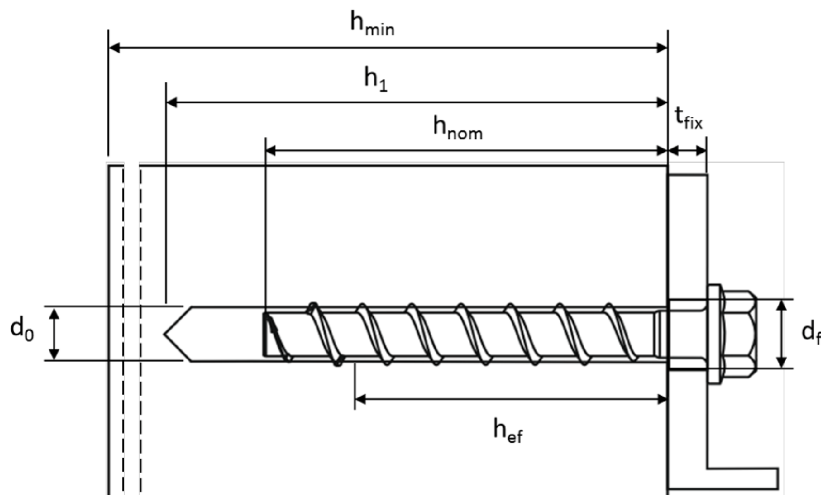











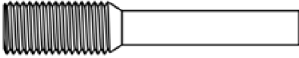

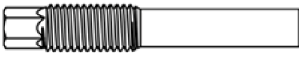

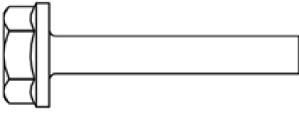

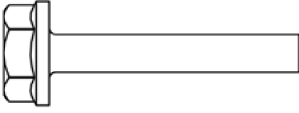

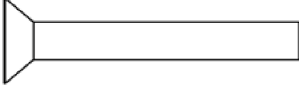

d_0 = nominal drill hole diameter
 t_{fix} = thickness of fixture
 d_f = clearance hole diameter

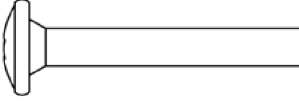
h_{min} = minimum thickness of member
 h_{nom} = nominal embedment depth
 h_1 = drill hole depth
 h_{ef} = effective embedment depth

TOGE concrete screw TSM High Performance

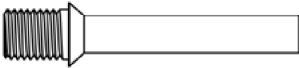
Product description
Product in installed condition

Annex A1

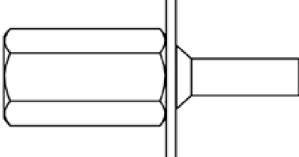
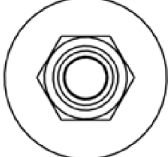
		1. Configuration with metric connection thread and hexagon socket e.g. TSM 8x105 M10 SW5
		2. Configuration with metric connection thread and hexagon drive e.g. TSM 8x105 M10 SW7
		3. Configuration with washer and hexagon head e.g. TSM 8x80 SW13 VZ 40
		4. Configuration with washer, hexagon head and TORX drive e.g. TSM 8x80 SW13
		5. Configuration with hexagon head e.g. TSM 8x80 SW13 OS
		6. Configuration with countersunk head and TORX drive e.g. TSM 8x80 C VZ 40
		7. Configuration with pan head and TORX drive e.g. TSM 8x80 P VZ 40
		8. Configuration with large pan head and TORX drive e.g. TSM 8x80 LP VZ 40
		9. Configuration with countersunk head and connection thread e.g. TSM 6x55 AG M8
		10. Configuration with hexagon drive and connection thread e.g. TSM 6x55 M8 SW10
		11. Configuration with internal thread and hexagon drive e.g. TSM 6x55 IM M8/10

TOGE concrete screw TSM High Performance

Product description
Screw types

Annex A2

English translation prepared by DIBt

Table 1: Material

Part	Product name	Material
all types	TSM high performance	- Steel EN 10263-4:2017 galvanized acc. to EN ISO 4042:2018 - Zinc flake coating according to EN ISO 10683:2018 ($\geq 5\mu\text{m}$)
	TSM high performance A4	1.4401; 1.4404; 1.4571; 1.4578
	TSM high performance HCR	1.4529

Part	Product name	Nominal characteristic steel		Rupture elongation A_5 [%]
		Yield strength f_{yk} [N/mm ²]	Ultimate strength f_{uk} [N/mm ²]	
all types	TSM high performance	560	700	≤ 8
	TSM high performance A4			
	TSM high performance HCR			

Table 2: Dimensions

Anchor size		6		8			10			12			14		
Nominal embedment depth	h_{nom}	1	2	1	2	3	1	2	3	1	2	3	1	2	3
	[mm]	40	55	45	55	65	55	75	85	65	85	100	75	100	115
Screw length	$\leq L$	[mm] 500													
Core diameter	d_k	5,1		7,1			9,1			11,1			13,1		
Thread outer diameter	d_s	7,5		10,6			12,6			14,6			16,6		
Shaft diameter	d_p	5,7		7,9			9,9			11,7			13,7		

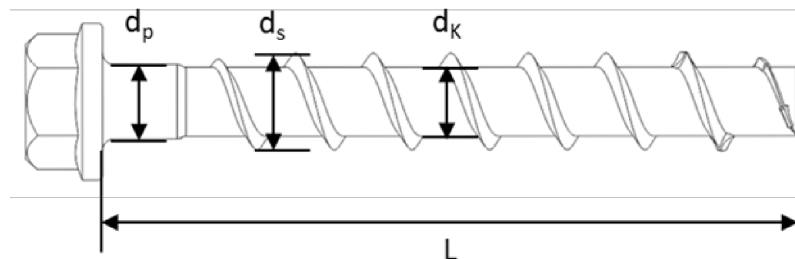

Marking:

TSM high performance

Screw type: TSM
Screw size: 10
Screw length: 100

TSM high performance A4

Screw type: TSM
Screw size: 10
Screw length: 100
Material: A4

TSM high performance HCR

Screw type: TSM
Screw size: 10
Screw length: 100
Material: HCR

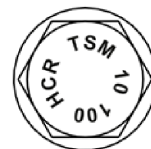
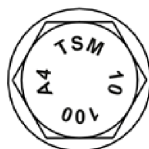

TOGE concrete screw TSM High Performance

Product description

Material, Dimensions and markings

Annex A3

Specification of Intended use

Table 3: Anchorages subject to

TSM concrete screw size		6		8			10			12			14					
Nominal embedment depth		h_{nom1}	h_{nom2}	h_{nom1}	h_{nom2}	h_{nom3}	h_{nom1}	h_{nom2}	h_{nom3}	h_{nom1}	h_{nom2}	h_{nom3}	h_{nom1}	h_{nom2}	h_{nom3}			
	[mm]	40	55	45	55	65	55	75	85	65	85	100	65	85	115			
Static and quasi-static loads		All sizes and all embedment depths																
Fire exposure		All sizes and all embedment depths																
C1 category - seismic																		
C2 category – seismic (A4 and HCR unsuitable)		x		x		ok		x		ok		x		ok		x		ok

Base materials:

- Reinforced and unreinforced concrete without fibers according to EN 206:2013.
- Strength classes C20/25 to C50/60 according to EN 206:2013.
- Cracked and uncracked concrete.

Use conditions (Environmental conditions):

- Concrete screws subject to dry internal conditions: all screw types.
- Structural subject to external atmospheric exposure (including industrial and marine environment) and to permanently damp internal condition no particular aggressive conditions exists: screw types made of stainless steel with marking A4.
- Structural subject to external atmospheric exposure (including industrial and marine environment) and to permanently damp internal condition if particular aggressive conditions exists: screw types made of stainless steel with marking HCR.

Note: Such particular aggressive conditions are e.g. permanent, alternating immersion in seawater or splash zone of seawater, chloride atmosphere of indoor swimming pools or atmosphere with chemical pollution (e.g. in desulphurization plants or road tunnels where de-icing materials are used).

TOGE concrete screw TSM High Performance

**Intended use
Specification**

Annex B1

Specification of Intended use - continuation

Design:

- Anchorages are to be designed under the responsibility of an engineer experienced in anchorages and concrete work.
- Verifiable calculation notes and drawings are to be prepared taking account of the loads to be anchored. The position of the anchor is indicated on the design drawings (e.g. position of the anchor relative to reinforcement or to supports, etc.).
- Anchorages are designed according to EN 1992-4:2018 and EOTA Technical Report TR 055. The design for shear load according to EN 1992-4:2018, Section 6.2.2 applies for all specified diameters d_f of clearance hole in the fixture in Annex B3, Table 4.

Installation:

- Hammer drilling or hollow drilling; hollow drilling only for sizes 8-14.
- Anchor installation carried out by appropriately qualified personnel and under the supervision of the person responsible for technical matters on site.
- In case of aborted hole: new drilling must be drilled at a minimum distance of twice the depth of aborted hole or closer, if the aborted hole is filled with high strength mortar and only if the hole is not in the direction of the oblique tensile or shear load.
- After installation further turning of the anchor must not be possible. The head of the anchor is supported in the fixture and is not damaged.
- The borehole may be filled with injection mortar Chemofast C-FT 300V or ATA 2004C.
- Adjustability according to Annex B6 for sizes 8-14, all embedment depths, but not for seismic loading
- Cleaning of borehole is not necessary, if using a hollow drill

TOGE concrete screw TSM High Performance

Intended use
Specification continuation

Annex B2

Table 4: Installation parameters

TSM concrete screw size		6		8			10		
Nominal embedment depth	h_{nom}	h_{nom1}	h_{nom2}	h_{nom1}	h_{nom2}	h_{nom3}	h_{nom1}	h_{nom2}	h_{nom3}
	[mm]	40	55	45	55	65	55	75	85
Nominal drill hole diameter	d_0	6		8			10		
Cutting diameter of drill bit	$d_{cut} \leq$	6,40		8,45			10,45		
Drill hole depth	$h_1 \geq$	45	60	55	65	75	65	85	95
Clearance hole diameter	$d_f \leq$	8		12			14		
Installation torque (version with connection thread)	T_{inst}	10		20			40		
Torque impact screw driver	[Nm]	Max. torque according to manufacturer's instructions							
		160		300			400		

TSM concrete screw size		12			14		
Nominal embedment depth	h_{nom}	h_{nom1}	h_{nom2}	h_{nom3}	h_{nom1}	h_{nom2}	h_{nom3}
	[mm]	65	85	100	75	100	115
Nominal drill hole diameter	d_0	12			14		
Cutting diameter of drill bit	$d_{cut} \leq$	12,50			14,50		
Drill hole depth	$h_1 \geq$	75	95	110	85	110	125
Clearance hole diameter	$d_f \leq$	16			18		
Installation torque (version with connection thread)	T_{inst}	60			80		
Torque impact screw driver	[Nm]	Max. torque according to manufacturer's instructions					
		650			650		

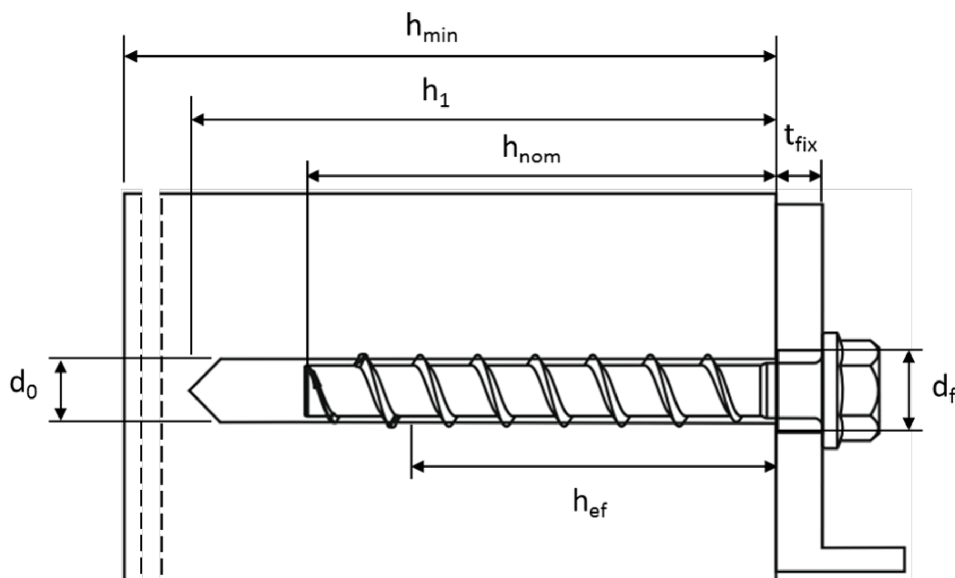

TOGE concrete screw TSM High Performance

Intended use
Installation parameters

Annex B3

Table 5: Minimum thickness of member, minimum edge distance and minimum spacing

TSM concrete screw size		6			8			10		
Nominal embedment depth	h_{nom}	h_{nom1}	h_{nom2}	h_{nom1}	h_{nom2}	h_{nom3}	h_{nom1}	h_{nom2}	h_{nom3}	
	[mm]	40	55	45	55	65	55	75	85	
Minimum thickness of member	h_{min}	[mm]	100	100		120	100	130		
Minimum edge distance	c_{min}	[mm]	40	40	50		50			
Minimum spacing	s_{min}	[mm]	40	40	50		50			

TSM concrete screw size		12			14			
Nominal embedment depth	h_{nom}	h_{nom1}	h_{nom2}	h_{nom3}	h_{nom1}	h_{nom2}	h_{nom3}	
	[mm]	65	85	100	75	100	115	
Minimum thickness of member	h_{min}	[mm]	120	130	150	130	150	170
Minimum edge distance	c_{min}	[mm]	50		70	50	70	
Minimum spacing	s_{min}	[mm]	50	70	50	70		

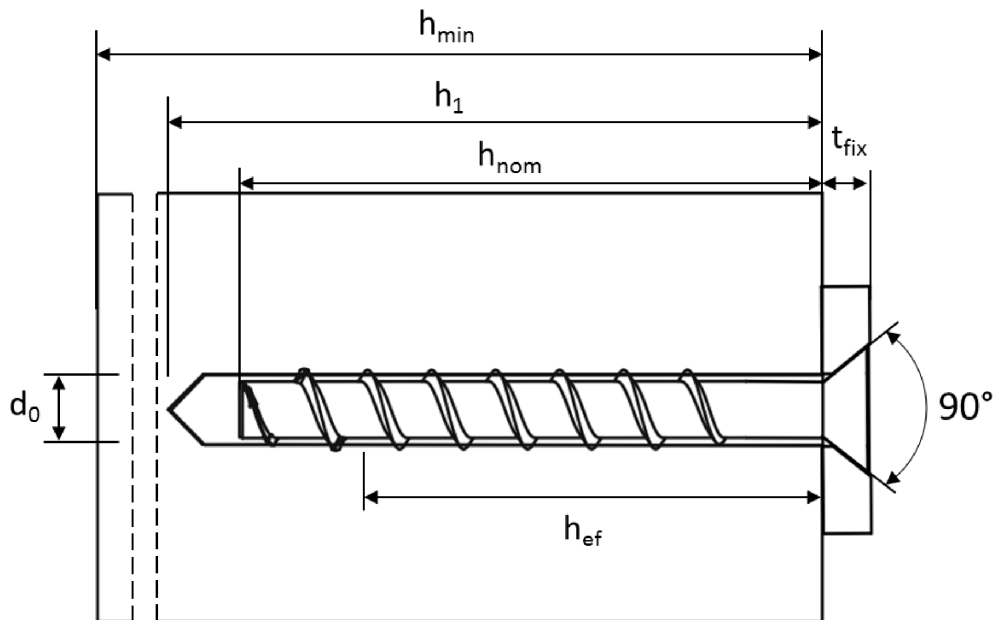

TOGE concrete screw TSM High Performance

Intended use

Minimum thickness of member, minimum edge distance and minimum spacing

Annex B4

Installation Instructions

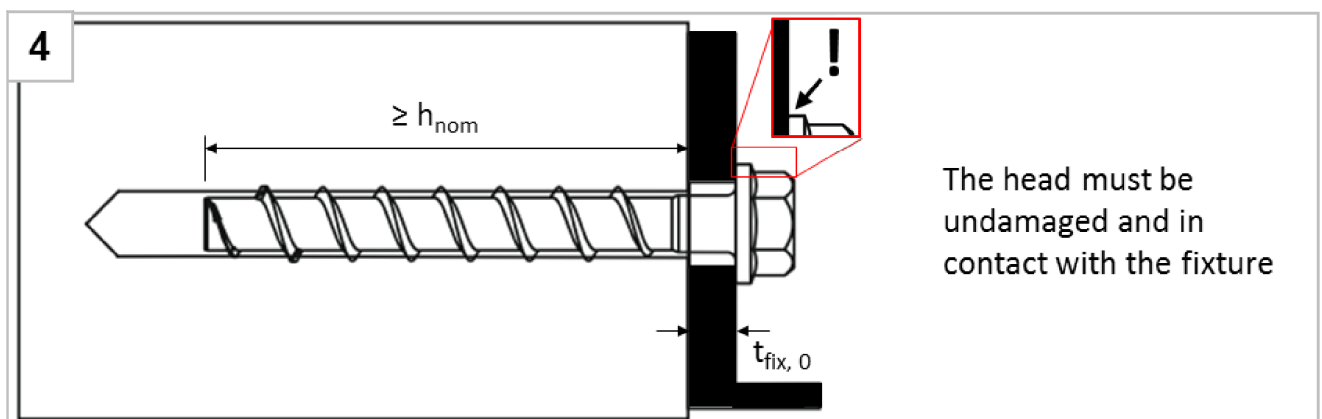
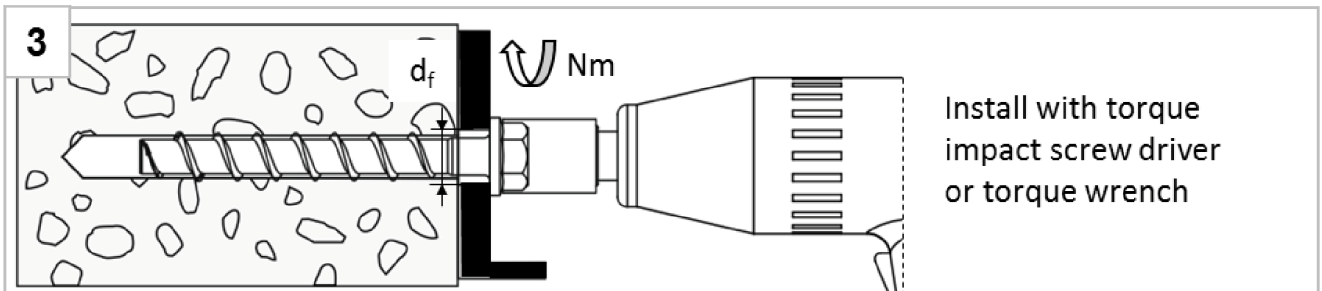
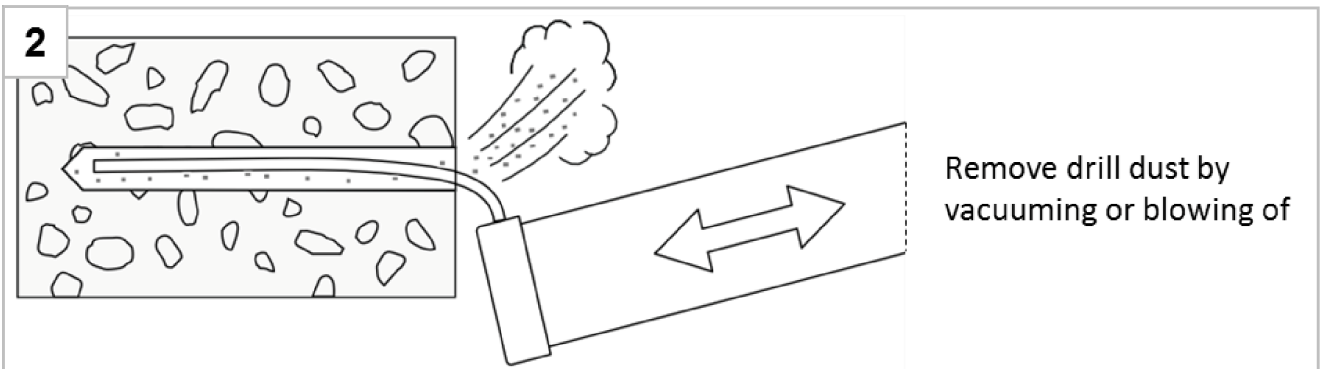
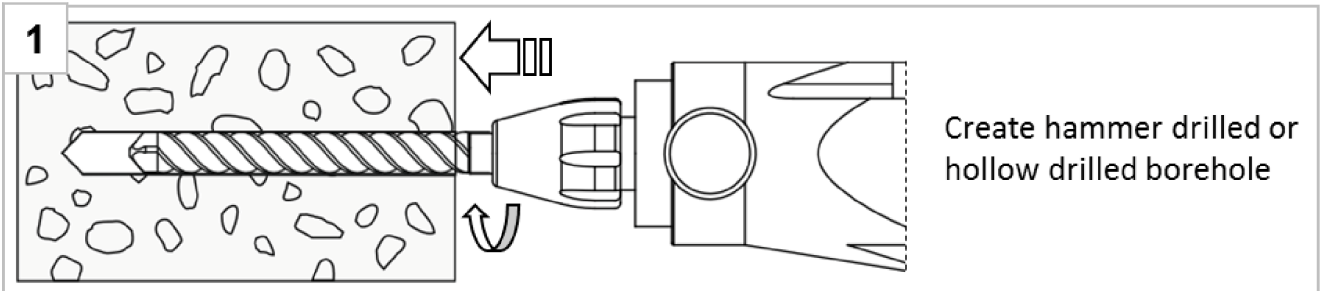

Note:

Cleaning of borehole is not necessary when using a hollow drill

TOGE concrete screw TSM High Performance

Intended use
Installation instructions

Annex B5

Installation Instructions – Adjustment

1. Adjustment

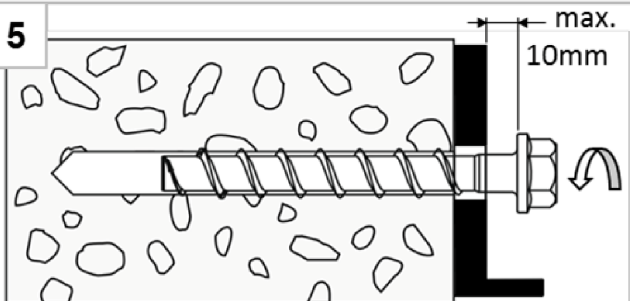

Screw may be untightened maximum 10mm

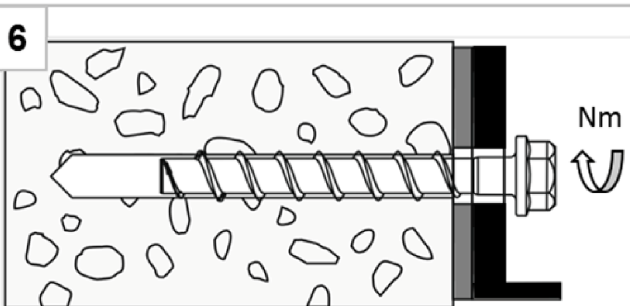

After adjustment, tighten the screw again

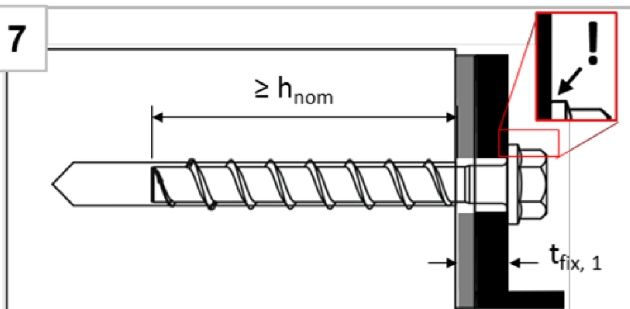

The head must be undamaged and in contact with the fixture

2. Adjustment

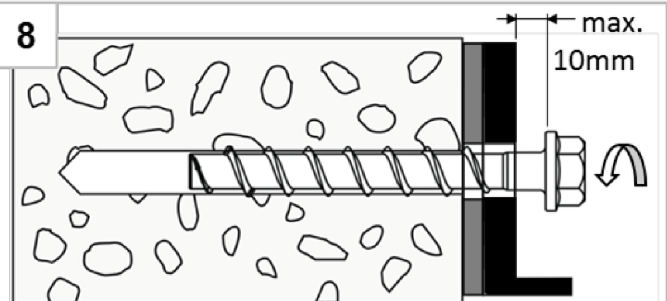

Screw may be untightened maximum 10mm

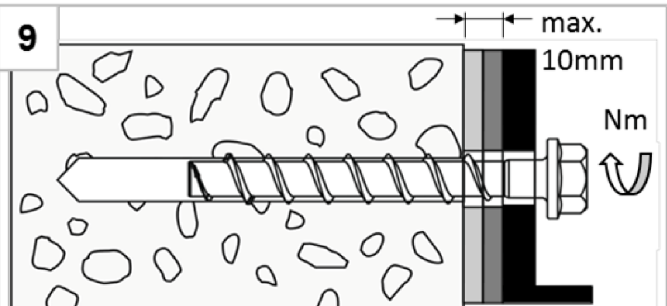

After adjustment, tighten the screw again

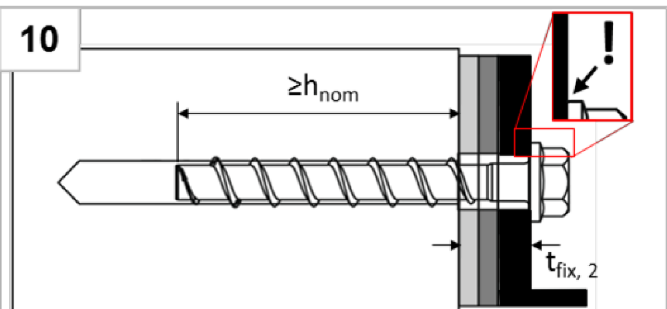

The head must be undamaged and in contact with the fixture

Notes:

1. Adjustment for seismic loading is not allowed
2. The fastener can be adjusted maximum two times. The total allowed thickness of shims added during the adjustment process is 10mm. The final embedment depth after adjustment process must be larger or equal than h_{nom} .

TOGE concrete screw TSM High Performance

Intended use
Installation instructions - Adjustment

Annex B6

Installation Instructions – Filling annular gap

Positioning of fixture and filling washer



After preparing borehole (Annex B5, figure 1+2), position first fixture (1), than filling washer (2)

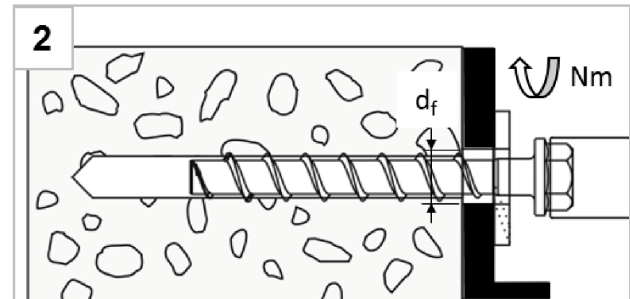

Install with torque impact screw driver or torque wrench

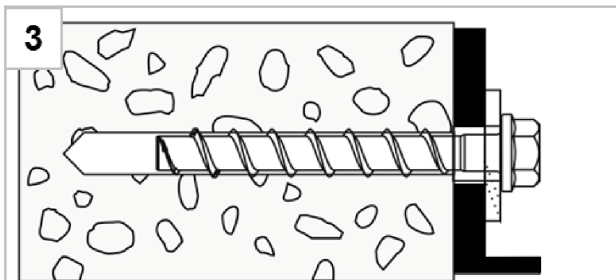

Installed condition without injected mortar in the filling washer

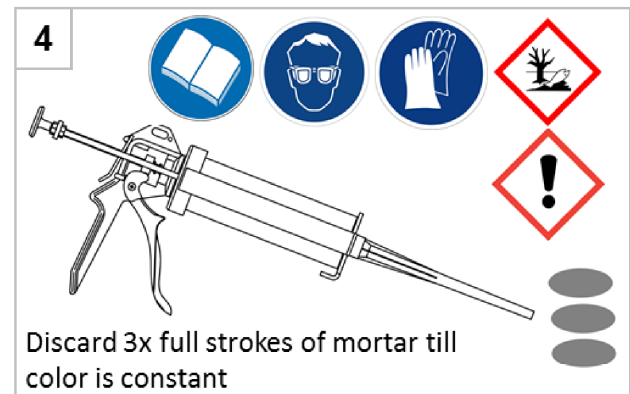

Discard 3x full strokes of mortar till color is constant

Filling the annular gap

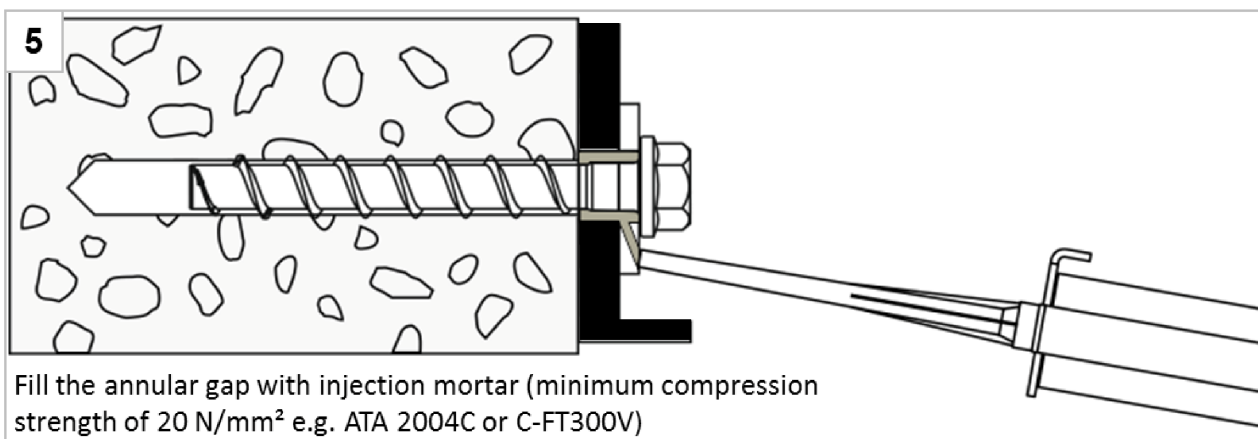

Fill the annular gap with injection mortar (minimum compression strength of 20 N/mm² e.g. ATA 2004C or C-FT300V)

Notes:

1. For seismic loading the installation with filled and without filled annular gap is approved. Differences in performance can be found in Annex C5 - C7.
2. No consideration of curing time is necessary.

TOGE concrete screw TSM High Performance

Intended use

Installation instructions - Filling annular gap

Annex B7

Table 6: Characteristic values for static and quasi-static loading, sizes 6-10

TSM concrete screw size			6			8			10		
Nominal embedment depth	h_{nom}		h_{nom1}	h_{nom2}	h_{nom1}	h_{nom2}	h_{nom3}	h_{nom1}	h_{nom2}	h_{nom3}	
	[mm]		40	55	45	55	65	55	75	85	
Steel failure for tension and shear loading											
Characteristic tension load	$N_{Rk,s}$	[kN]	14,0			27,0			45,0		
Partial factor tension load	$\gamma_{Ms,N}$	[-]	1,5								
Characteristic shear load	$V_{Rk,s}$	[kN]	7,0		13,5		17,0	22,5	34,0		
Partial factor shear load	$\gamma_{Ms,V}$	[-]	1,25								
Ductility factor	k_7	[-]	0,8								
Characteristic bending load	$M^0_{Rk,s}$	[Nm]	10,9			26,0			56,0		
Pull-out failure											
Character- istic tension load C20/25	cracked	$N_{Rk,p}$	[kN]	2,0	4,0	5,0	9,0	12,0	9,0	$\geq N^0_{Rk,c}$	
	uncracked	$N_{Rk,p}$	[kN]	4,0	9,0	7,5	12,0	16,0	12,0	20,0	26,0
Increasing factor for $N_{Rk,p}$	C20/25	Ψ_c	[-]	1,12							
	C30/37			1,22							
	C40/50			1,41							
	C50/60			1,58							
Concrete failure: Splitting failure, concrete cone failure and pry-out failure											
Effective embedment depth	h_{ef}	[mm]	31	44	35	43	52	43	60	68	
k-factor	cracked	$k_1 = k_{cr}$	[-]	7,7							
	uncracked	$k_1 = k_{ucr}$	[-]	11,0							
Concrete cone failure	spacing	$s_{cr,N}$	[mm]	$3 \times h_{ef}$							
	edge distance	$c_{cr,N}$	[mm]	$1,5 \times h_{ef}$							
Splitting failure	spacing	$s_{cr,Sp}$	[mm]	120	160	120	140	150	140	180	210
	edge distance	$c_{cr,Sp}$	[mm]	60	80	60	70	75	70	90	105
Factor for pry-out failure	k_8	[-]	1,0						2,0		
Installation factor	γ_{inst}	[-]	1,0								
Concrete edge failure											
Effective length in concrete	$l_f = h_{ef}$	[mm]	31	44	35	43	52	43	60	68	
Nominal outer diameter of screw	d_{nom}	[mm]	6			8			10		

TOGE concrete screw TSM High Performance

Performances

Characteristic values for static and quasi-static loading, sizes 6-10

Annex C1

Table 7: Characteristic values for static and quasi-static loading, sizes 12-14

TSM concrete screw size			12			14			
Nominal embedment depth	h_{nom}		h_{nom1}	h_{nom2}	h_{nom3}	h_{nom1}	h_{nom2}	h_{nom3}	
	[mm]		65	85	100	75	100	115	
Steel failure for tension and shear loading									
Characteristic tension load	$N_{Rk,s}$	[kN]	67,0			94,0			
Partial factor tension load	$\gamma_{Ms,N}$	[-]	1,5						
Characteristic shear load	$V_{Rk,s}$	[kN]	33,5	42,0		56,0			
Partial factor shear load	$\gamma_{Ms,V}$	[-]	1,25						
Ductility factor	k_7	[-]	0,8						
Characteristic bending load	$M^0_{Rk,s}$	[Nm]	113,0			185,0			
Pull-out failure									
Characteristic tension load C20/25	cracked	$N_{Rk,p}$	[kN]	12,0	$\geq N^0_{Rk,c}$				
	uncracked	$N_{Rk,p}$	[kN]	16,0					
Increasing factor for $N_{Rk,p}$	C20/25	Ψ_c	[-]	1,12					
	C30/37			1,22					
	C40/50			1,41					
	C50/60			1,58					
Concrete failure: Splitting failure, concrete cone failure and pry-out failure									
Effective embedment depth	h_{ef}	[mm]	50	67	80	58	79	92	
k-factor	cracked	$k_1 = k_{cr}$	[-]	7,7					
	uncracked	$k_1 = k_{ucr}$	[-]	11,0					
Concrete cone failure	spacing	$s_{cr,N}$	[mm]	$3 \times h_{ef}$					
	edge distance	$c_{cr,N}$	[mm]	$1,5 \times h_{ef}$					
Splitting failure	spacing	$s_{cr,Sp}$	[mm]	150	210	240	180	240	280
	edge distance	$c_{cr,Sp}$	[mm]	75	105	120	90	120	140
Factor for pry-out failure	k_8	[-]	1,0	2,0		1,0	2,0		
Installation factor	γ_{inst}	[-]	1,0						
Concrete edge failure									
Effective length in concrete	$l_f = h_{ef}$	[mm]	50	67	80	58	79	92	
Nominal outer diameter of screw	d_{nom}	[mm]	12			14			

TOGE concrete screw TSM High Performance

Performances

Characteristic values for static and quasi-static loading, sizes 12-14

Annex C2

Table 8: Seismic category C1 – Characteristic load values

TSM concrete screw size			8	10	12	14
Nominal embedment depth	h_{nom}		h_{nom3}			
	[mm]		65	85	100	115
Steel failure for tension and shear load						
Characteristic load	$N_{Rk,s,eq}$	[kN]	27,0	45,0	67,0	94,0
Partial factor tension load	γ_{Ms}	[-]	1,5			
Characteristic load	$V_{Rk,s,eq}$	[kN]	8,5	15,3	21,0	22,4
Partial factor shear load	γ_{Ms}	[-]	1,25			
With filling of the annular gap ¹⁾	α_{gap}	[-]	1,0			
Without filling of the annular gap	α_{gap}	[-]	0,5			
Pull-out failure						
Characteristic tension load in cracked concrete C20/25	$N_{Rk,p,eq}$	[kN]	12,0	$\geq N_{Rk,c}^0$		
Concrete cone failure						
Effective embedment depth	h_{ef}	[mm]	52	68	80	92
Edge distance	$c_{cr,N}$	[mm]	$1,5 \times h_{ef}$			
Spacing	$s_{cr,N}$	[mm]	$3 \times h_{ef}$			
Installation safety factor	γ_{inst}	[-]	1,0			
Concrete pry-out failure						
Factor for pry-out failure	k_8	[-]	1,0	2,0		
Concrete edge failure						
Effective length in concrete	$l_f = h_{ef}$	[mm]	52	68	80	92
Nominal outer diameter of screw	d_{nom}	[mm]	8	10	12	14

1) Filling of the annular gap according to annex B7, figure 5

TOGE concrete screw TSM High Performance

Performances
Seismic category C1 – Characteristic load values

Annex C3

Table 9: Seismic category C2 ¹⁾ – Characteristic load values with filled annular gap according to annex B7, figure 5

TSM concrete screw size			8	10	12	14
Nominal embedment depth	h_{nom}		h_{nom3}			
	[mm]		65	85	100	115
Steel failure for tension						
Characteristic load	$N_{Rk,s,eq}$	[kN]	27,0	45,0	67,0	94,0
Partial factor tension load	γ_{Ms}	[-]	1,5			
With filling of the annular gap	α_{gap}	[-]	1,0			
Pull-out failure						
Characteristic load in cracked concrete	$N_{Rk,p,eq}$	[kN]	2,4	5,4	7,1	10,5
Steel failure for shear load						
Characteristic load	$V_{Rk,s,eq}$	[kN]	9,9	18,5	31,6	40,7
Partial factor shear load	γ_{Ms}	[-]	1,25			
With filling of the annular gap	α_{gap}	[-]	1,0			
Concrete cone failure						
Effective embedment depth	h_{ef}	[mm]	52	68	80	92
Edge distance	$c_{cr,N}$	[mm]	$1,5 \times h_{ef}$			
Spacing	$s_{cr,N}$	[mm]	$3 \times h_{ef}$			
Installation safety factor	γ_{inst}	[-]	1,0			
Concrete pry-out failure						
Factor for pry-out failure	k_g	[-]	2,0			
Concrete edge failure						
Effective length in concrete	$l_f = h_{ef}$	[mm]	52	68	80	92
Nominal outer diameter of screw	d_{nom}	[mm]	8	10	12	14

1) A4 and HCR not suitable

TOGE concrete screw TSM High Performance

Performances

Seismic category C2 – Characteristic load values with filled annular gap

Annex C4

Table 10: Seismic category C2 ¹⁾ – Characteristic load values **without filled annular gap according to annex B7, figure 3**

TSM concrete screw size			8	10	12	14
Nominal embedment depth	h_{nom}		h_{nom3}			
	[mm]		65	85	100	115
Steel failure for tension (hexagon head type)						
Characteristic load	$N_{Rk,s,eq}$	[kN]	27,0	45,0	67,0	94,0
Partial factor tension load	γ_{Ms}	[-]	1,5			
Pull-out failure (hexagon head type)						
Characteristic load in cracked concrete	$N_{Rk,p,eq}$	[kN]	2,4	5,4	7,1	10,5
Steel failure for shear load (hexagon head type)						
Characteristic load	$V_{Rk,s,eq}$	[kN]	10,3	21,9	24,4	23,3
Partial factor shear load	γ_{Ms}	[-]	1,25			
Without filling of the annular gap	α_{gap}	[-]	0,5			
Steel failure for tension (countersunk head type)						
Characteristic load	$N_{Rk,s,eq}$	[kN]	27,0	45,0	-	
Partial factor tension load	γ_{Ms}	[-]	1,5			-
Pull-out failure (countersunk head type)						
Characteristic load in cracked concrete	$N_{Rk,p,eq}$	[kN]	2,4	5,4	-	
Steel failure for shear load (countersunk head type)						
Characteristic load	$V_{Rk,s,eq}$	[kN]	3,6	13,7	-	
Partial factor shear load	γ_{Ms}	[-]	1,25			-
Without filling of the annular gap	α_{gap}	[-]	0,5			-
Concrete cone failure						
Effective embedment depth	h_{ef}	[mm]	52	68	80	92
Edge distance	$c_{cr,N}$	[mm]	1,5 x h_{ef}			
Spacing	$s_{cr,N}$	[mm]	3 x h_{ef}			
Installation safety factor	γ_{inst}	[-]	1,0			
Concrete pry-out failure						
Factor for pry-out failure	k_g	[-]	2,0			
Concrete edge failure						
Effective length in concrete	$l_f = h_{ef}$	[mm]	52	68	80	92
Nominal outer diameter of screw	d_{nom}	[mm]	8	10	12	14

1) A4 and HCR not suitable

TOGE concrete screw TSM High Performance

Performances

Seismic category C2 – Characteristic load values without filled annular gap

Annex C5

Table 11: Fire exposure – characteristic values of resistance

TSM concrete screw size			6			8			10			12			14			
Nominal embedment depth	h_{nom}		1	2	1	2	3	1	2	3	1	2	3	1	2	3		
	[mm]		40	55	45	55	65	55	75	85	65	85	100	75	100	115		
Steel failure for tension and shear load ($F_{Rk,s,fi} = N_{Rk,s,fi} = V_{Rk,s,fi}$)																		
characteristic Resistance	R30	$F_{Rk,s,fi30}$	[kN]	0,9			2,4			4,4			7,3			10,3		
	R60	$F_{Rk,s,fi60}$	[kN]	0,8			1,7			3,3			5,8			8,2		
	R90	$F_{Rk,s,fi90}$	[kN]	0,6			1,1			2,3			4,2			5,9		
	R120	$F_{Rk,s,fi120}$	[kN]	0,4			0,7			1,7			3,4			4,8		
	R30	$M^0_{Rk,s,fi30}$	[Nm]	0,7			2,4			5,9			12,3			20,4		
	R60	$M^0_{Rk,s,fi60}$	[Nm]	0,6			1,8			4,5			9,7			15,9		
	R90	$M^0_{Rk,s,fi90}$	[Nm]	0,5			1,2			3,0			7,0			11,6		
	R120	$M^0_{Rk,s,fi120}$	[Nm]	0,3			0,9			2,3			5,7			9,4		
Pull-out failure																		
Characteristic Resistance	R30-R90	$N_{Rk,p,fi}$	[kN]	0,5	1,0	1,3	2,3	3,0	2,3	4,0	4,8	3,0	4,7	6,2	3,8	6,0	7,6	
	R120	$N_{Rk,p,fi}$	[kN]	0,4	0,8	1,0	1,8	2,4	1,8	3,2	3,9	2,4	3,8	4,9	3,0	4,8	6,1	
Concrete cone failure																		
Characteristic Resistance	R30-R90	$N^0_{Rk,c,fi}$	[kN]	0,9	2,2	1,2	2,1	3,4	2,1	4,8	6,6	3,0	6,3	9,9	4,4	9,6	14,0	
	R120	$N^0_{Rk,c,fi}$	[kN]	0,7	1,8	1,0	1,7	2,7	1,7	3,8	5,3	2,4	5,1	7,9	3,5	7,6	11,2	
Edge distance																		
R30 bis R120	$c_{cr,fi}$	[mm]	2 x h_{ef}															
In case of fire attack from more than one side, the minimum edge distance shall be ≥ 300 mm.																		
Spacing																		
R30 bis R120	$s_{cr,fi}$	[mm]	4 x h_{ef}															
Pry-out failure																		
R30 bis R120	k_8	[-]	1,0			2,0			1,0	2,0			1,0	2,0				
The anchorage depth has to be increased for wet concrete by at least 30 mm compared to the given value.																		
TOGE concrete screw TSM High Performance														Annex C6				
Performances Fire exposure – characteristic values of resistance																		

Table 12: Displacements under static and quasi-static tension load

TSM concrete screw size				6			8			10		
Nominal embedment depth			h_{nom}	h_{nom1}	h_{nom2}	h_{nom1}	h_{nom2}	h_{nom3}	h_{nom1}	h_{nom2}	h_{nom3}	
			[mm]	40	55	45	55	65	55	75	85	
Cracked concrete	tension load	N	[kN]	0,95	1,9	2,4	4,3	5,7	4,3	7,9	9,6	
	displacement	δ_{N0}	[mm]	0,3	0,6	0,6	0,7	0,8	0,6	0,5	0,9	
		$\delta_{N\infty}$	[mm]	0,4	0,4	0,6	1,0	0,9	0,4	1,2	1,2	
Uncracked concrete	tension load	N	[kN]	1,9	4,3	3,6	5,7	7,6	5,7	9,5	11,9	
	displacement	δ_{N0}	[mm]	0,4	0,6	0,7	0,9	0,5	0,7	1,1	1,0	
		$\delta_{N\infty}$	[mm]	0,4	0,4	0,6	1,0	0,9	0,4	1,2	1,2	

TSM concrete screw size				12			14		
Nominal embedment depth			h_{nom}	h_{nom1}	h_{nom2}	h_{nom3}	h_{nom1}	h_{nom2}	h_{nom3}
			[mm]	65	85	100	75	100	115
Cracked concrete	tension load	N	[kN]	5,7	9,4	12,3	7,6	12,0	15,1
	displacement	δ_{N0}	[mm]	0,9	0,5	1,0	0,5	0,8	0,7
		$\delta_{N\infty}$	[mm]	1,0	1,2	1,2	0,9	1,2	1,0
Uncracked concrete	tension load	N	[kN]	7,6	13,2	17,2	10,6	16,9	21,2
	displacement	δ_{N0}	[mm]	1,0	1,1	1,2	0,9	1,2	0,8
		$\delta_{N\infty}$	[mm]	1,0	1,2	1,2	0,9	1,2	1,0

Table 13: Displacements under static and quasi-static shear load

TSM concrete screw size				6			8			10		
Nominal embedment depth			h_{nom}	h_{nom1}	h_{nom2}	h_{nom1}	h_{nom2}	h_{nom3}	h_{nom1}	h_{nom2}	h_{nom3}	
			[mm]	40	55	45	55	65	55	75	85	
Cracked and uncracked concrete	shear load	V	[kN]	3,3			8,6			16,2		
	displacement	δ_{V0}	[mm]	1,55			2,7			2,7		
		$\delta_{V\infty}$	[mm]	3,1			4,1			4,3		

TSM concrete screw size				12			14		
Nominal embedment depth			h_{nom}	h_{nom1}	h_{nom2}	h_{nom3}	h_{nom1}	h_{nom2}	h_{nom3}
			[mm]	65	85	100	75	100	115
Cracked and uncracked concrete	shear load	V	[kN]	20,0			30,5		
	displacement	δ_{V0}	[mm]	4,0			3,1		
		$\delta_{V\infty}$	[mm]	6,0			4,7		

TOGE concrete screw TSM High Performance

Performances
Displacements under static and quasi-static loads

Annex C7

Table 14: Seismic category C2 ¹⁾ – Displacements **with filled annular gap**
according to annex B7, figure 5

TSM concrete screw size			8	10	12	14
Nominal embedment depth	h_{nom}		h_{nom3}			
	[mm]		65	85	100	115
Displacements under tension loads (hexagon head type)						
Displacement DLS	$\delta_{N,eq(DLS)}$	[mm]	0,66	0,32	0,57	1,16
Displacement ULS	$\delta_{N,eq(ULS)}$	[mm]	1,74	1,36	2,36	4,39
Displacements under shear loads (hexagon head type with hole clearance)						
Displacement DLS	$\delta_{V,eq(DLS)}$	[mm]	1,68	2,91	1,88	2,42
Displacement ULS	$\delta_{V,eq(ULS)}$	[mm]	5,19	6,72	5,37	9,27

Table 15: Seismic category C2 ¹⁾ – Displacements **without filled annular gap**
according to annex B7, figure 3

TSM concrete screw size			8	10	12	14
Nominal embedment depth	h_{nom}		h_{nom3}			
	[mm]		65	85	100	115
Displacements under tension loads (hexagon head type)						
Displacement DLS	$\delta_{N,eq(DLS)}$	[mm]	0,66	0,32	0,57	1,16
Displacement ULS	$\delta_{N,eq(ULS)}$	[mm]	1,74	1,36	2,36	4,39
Displacements under tension loads (countersunk head type)						
Displacement DLS	$\delta_{N,eq(DLS)}$	[mm]	0,66	0,32	-	
Displacement ULS	$\delta_{N,eq(ULS)}$	[mm]	1,74	1,36		
Displacements under shear loads (hexagon head type with hole clearance)						
Displacement DLS	$\delta_{V,eq(DLS)}$	[mm]	4,21	4,71	4,42	5,60
Displacement ULS	$\delta_{V,eq(ULS)}$	[mm]	7,13	8,83	6,95	12,63
Displacements under shear loads (countersunk head type with hole clearance)						
Displacement DLS	$\delta_{V,eq(DLS)}$	[mm]	2,51	2,98	-	
Displacement ULS	$\delta_{V,eq(ULS)}$	[mm]	7,76	6,25		

1) A4 and HCR not suitable

TOGE concrete screw TSM High Performance

Performances
Displacements under seismic loads

Annex C8