

AUTOMATIC PILL DISPENSER

User Guide

LVFRAPD5

Thank you for purchasing the LiveFine® Automatic Pill Dispenser. This User Guide is intended to provide you with guidelines to ensure that operation of this product is safe and does not pose risk to the user. Any use that does not conform to the guidelines described in this User Guide may void the limited warranty.

Please read all directions before using the product and retain this guide for reference. This product is intended for household use only. It is not intended for commercial use.

This product is covered by a limited one-year warranty. Coverage is subject to limits and exclusions. See warranty for details.

Tips and Precautions

- Do not let children use or play with this device.
- Do not use any attachments not supplied or recommended by the manufacturer.
- Do not place the appliance near open flames or heat sources. Fire, electric shock, product damage, or injury might occur.
- Make sure to keep the pill dispenser on a flat, stable surface. Do not flip it upside down unless you are removing pills from their compartment. Please note, the internal pill container is removable for easy filling.
- Be careful not to drop the pill dispenser, as this could damage the product or the pills inside.
- Water can damage the dispenser, cause issues with the batteries, or otherwise adversely affect the medication contained inside. Do not immerse this pill dispenser in water or other liquids, or expose it to liquids that might get splashed on it. Do not place it in an environment where there is excessive moisture or humidity.
- Do not fill the internal pill container unless it is completely dry.
- Never force the locking cover open.
- Never use mismatched batteries, or batteries with wrappings that have been torn or damaged in any way.
- Do not mix old and new batteries.
- Organizing medications correctly and assigning quantities and times is the sole responsibility of the user and/or their caregiver or healthcare provider. LiveFine® is not liable for missed medications.
- If you do miss a dose for any reason, please contact your healthcare provider and/or follow the directions provided by your physician or pharmacist.

- Some medications should be stored tightly sealed and not exposed to the air. If you are uncertain about whether this dispenser is appropriate for storing your medications, please check with your healthcare provider or pharmacist.
- A low battery symbol  will appear in the upper right corner of the LCD display when battery power is low. Be sure to change the batteries promptly to ensure the proper operation of the pill dispenser.

Product Features

1. **Automatic Pill Alerts:** The system will repeatedly flash the light indicator ring, rotate the internal pill container, and sound a beeping alarm every seven (7) seconds, until the unit has been fully inverted, for a period of up to 30 minutes, according to the schedule you set.
2. **Automatic Dispensing System:** Automatically rotates the carousel at the designated pill times to prevent forgotten or double doses. Displays the time on an LCD display for further accuracy in dosage monitoring.
3. **28 Spacious Pill Compartments:** The internal pill container features ample space in each compartment to accommodate multiple pills or tablets, so you can fit all the pills you need to take at a designated time in the same slot.
4. **Clear, Removable Carousel:** Lift the internal pill container out of the main body of the device for easy refilling. The container automatically rotates according to the schedule you set.
5. **Interchangeable Daily Dosage Rings:** The six (6) interchangeable rings included help you keep track of the medications you take per day, and guide you through which pills go in which slots.
6. **Locking Cover:** The powerful latch and the manual locking key help keep your medications secure and prevent messes or spills, unwanted tampering, accidental removal, or theft.
7. **Mini Magnifying Glass:** The magnifying glass above the dosage window helps you get a closer look at your corresponding dosage information, and see pills clearly.
8. **Pill Delivery Door:** The easy-slide window to access your pills at dosage times is much easier on fingers and joints than traditional “flip-open” pill containers. Once the internal pill container rotates into the correct position, simply slide open the door and invert the unit to receive your medication and simultaneously stop the alarm.

9. **Easy-to-Read LCD Display:** The large numbers on the LCD display show the clock time in either 12- or 24-hour times for your convenience. The three touch buttons underneath allow you to set alarms, adjust the volume, switch between 12/24-hour time display, and choose between the two types of alarms.
10. **Battery Operation:** The automatic pill dispenser runs on four (4) AA alkaline batteries, and never needs to be plugged in or charged. (But make sure you have extra batteries on hand!) You can stay on track with your medications wherever you may go, without needing to worry about charging cables or outlet access.

Package Contents

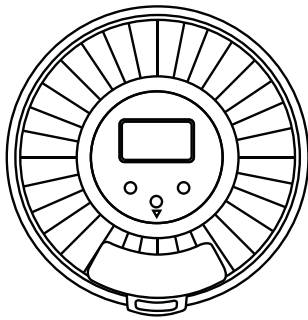

LiveFine[®] Automatic
Pill Dispenser

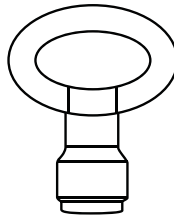

Locking key

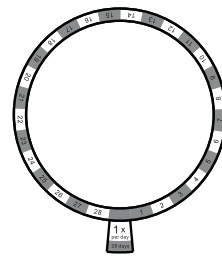

Dosage rings

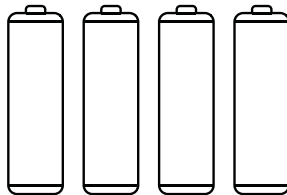

AA alkaline
batteries (4)

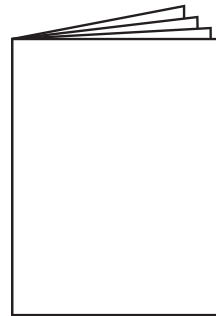

User guide

Parts and Controls

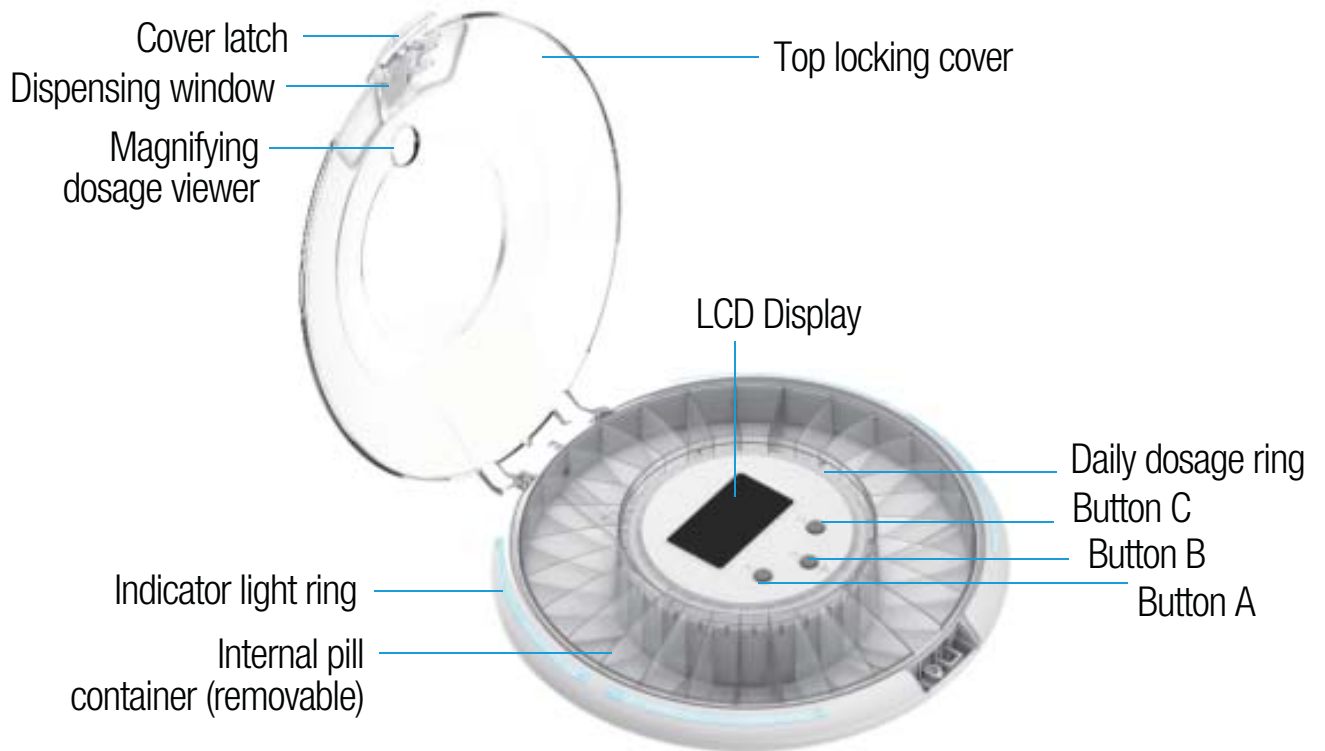

Understanding the Daily Dosage Rings

Your automatic pill dispenser comes with 6 different rings, corresponding to the number of times per day that medication needs to be dispensed. The rings are designed to help you in laying out medication in the internal pill container so it is properly dispensed. The internal pill compartment has 28 slots for medication.

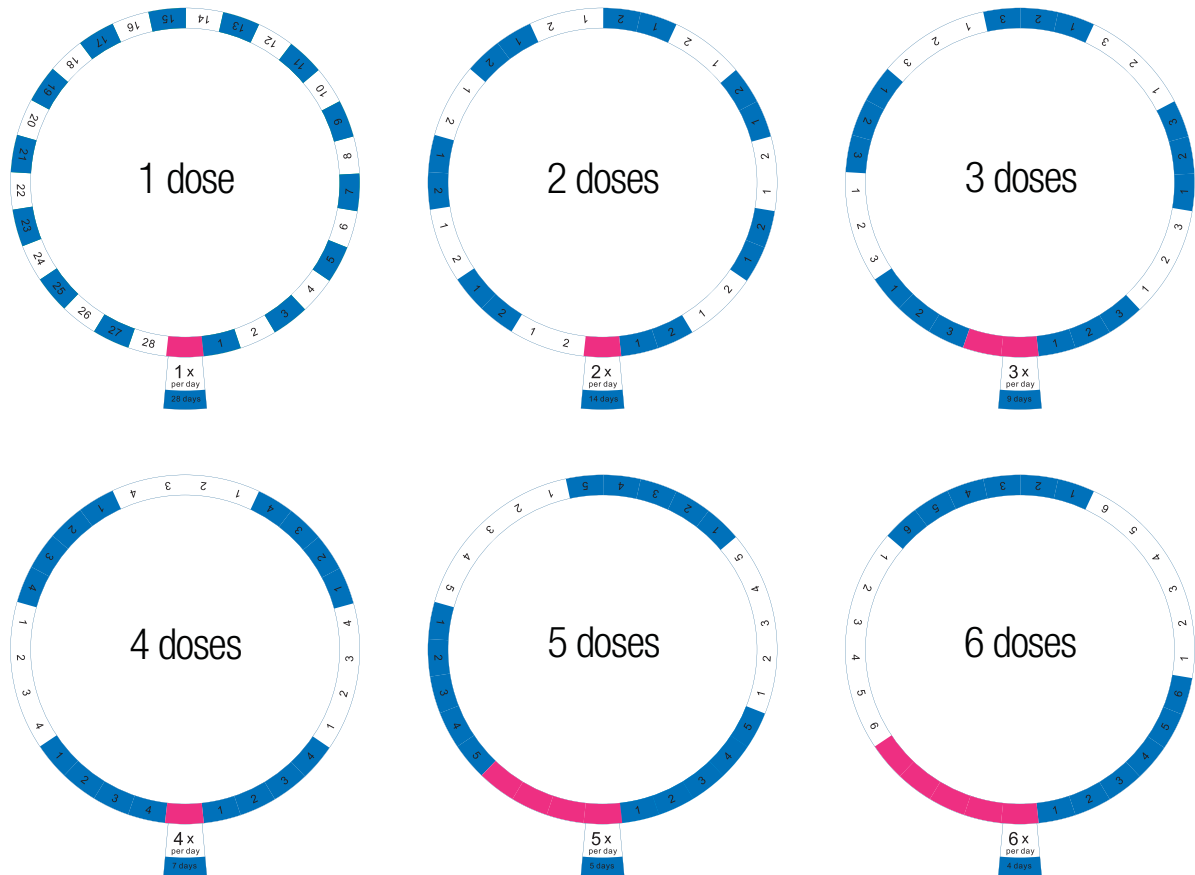

The dosage ring must first be placed in the center of the internal pill container with the tab in the bottom spot (indicated by the ▲ on the plastic container) before you start filling it with medication. Once the dosage ring is properly situated, the alternating colors help you to distinguish between days. For example, if you are using the 2x Per Day ring (meaning medication only needs to be dispensed at two different times each day), this will accommodate 14 days' worth of medication. The blue numbers to the right of the tab are the first day's medications. The white spaces are the following day's medications. The colors alternate so that days do not get confused. The space marked "1" is where you would put the first dose for that day, the space marked "2"

is where you would put all medications to be dispensed at the second time, etc. The pill compartments should accommodate all necessary medications in a single slot.

DO NOT PUT MEDICATION IN THE SLOTS INDICATED BY THE RED SPACES.

These spaces indicate remainder times. For example, if you need medication dispensed at 5 different times during the day, the ring can accommodate 5 days, or 25 medication times. Three slots are left over. These leftover slots are indicated by the red ring, and this is why there are substantially larger red areas on the 5x per day and 6x per day rings. Do not put medication in those slots.

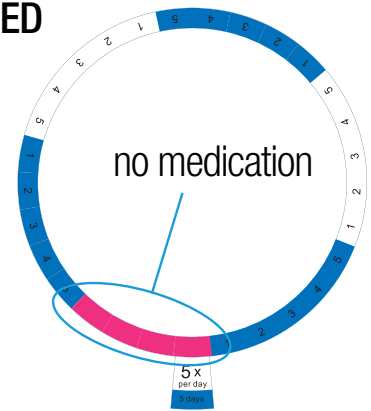

To use the Daily Dosage Rings, choose the ring with the tab that correctly indicates how many times per day you need medication dispensed. Position the ring around the compartment. Fill each compartment accordingly and then place the carousel back into the dispenser with the dosage ring.

Ring #	# of Meds per Day	Programmable Time Period
1	1	28 days
2	2	14 days
3	3	9 days
4	4	7 days
5	5	5 days
6	6	4 days

Installing the Batteries

1. Turn the dispenser upside-down. Release the battery latch by sliding it toward the outer edge of the dispenser until it clicks.
2. Remove the battery door.
3. Insert four (4) AA alkaline batteries, making sure to match the polarities (+ and – sides) with the + and - markings inside the compartment.
4. Replace the battery door.
5. Slide the battery latch toward the battery door until it clicks into place.

Locking and Unlocking the Cover

The cover lock helps to prevent accidental spills and prevents unwanted access to your medication dispenser. This can also help with patients who are confused and may try to take medication at the wrong times.

1. Take the metal key and line it up with the notches on the cover lock (located on the bottom of the dispenser as shown).
2. You will see a vertical line at the top, and a horizontal line with the letter L on the left side. Press down on the cover latch and turn the key toward the L (counterclockwise) to lock the cover in place.
3. Turn the key toward the vertical line (clockwise) to unlock the cover.
4. Lift the cover open using the cover latch.

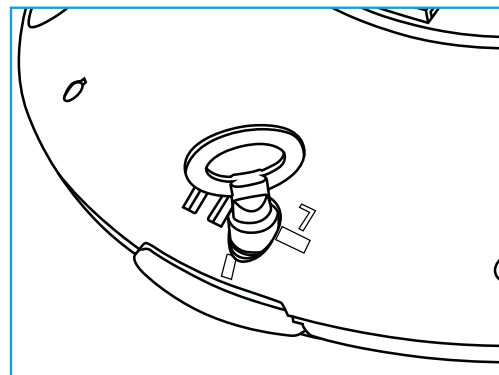

Setting the Time

1. Press and hold the **A** button for approximately three (3) seconds, until the **■** stops flashing.
2. Press the **B** button to adjust the hours and press the **C** button to adjust the minutes, until the time is correct.
3. When finished, press the **A** button again to return to Clock Mode.

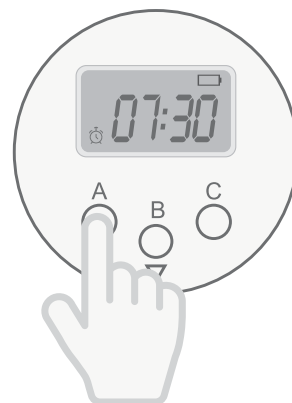

Setting the Volume, Alarm Type, and 12-Hour/24-Hour Time

1. While on Clock Mode (not setting any alarms), press the **C** button once to enter the time and volume menu.
2. You will see a number in the bottom left corner that says 0, 1, or 2; either a 12 or 24 in the middle; and either a 1 or a 2 on the right side.
3. Press **C** to switch between 12/24 hour modes. The middle number will change from 12 to 24.



- Set the volume level by pressing **B** to switch between 0 (mute), 1 (low volume), and 2 (high volume). The small number on the left side will change accordingly.



- Switch between the two alarm types from this menu by pressing the **C** button and holding it for three (3) seconds. The number on the right side of the menu will switch between 1 (slow beeps) and 2 (rapid beeps).

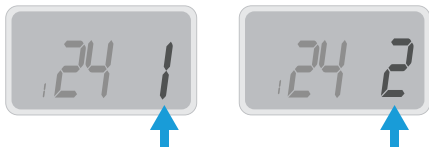

- When you are finished in this menu, press **A** at any time to return to Clock Mode, or wait for 15 seconds and it will return to Clock Mode on its own.

Setting Medication Times

- Press the **A** button to enter the Alarm Menu. A clock icon will appear in the bottom left corner, with a number next to it. This number indicates which alarm you are setting. You do not have to set all six alarms if you do not need medication dispensed six times a day.
- Press the **B** button to adjust the hour of the alarm. To move through the hours faster, you can press and hold the **B** button.
- Press the **C** button to adjust the minutes of the alarm. To move through the minutes faster, you can press and hold the **C** button.
- Make sure the AM/PM setting is correct, if you are not using 24-hour time.
- To confirm and finalize the alarm, press the **A** button to move to the next alarm.
- Repeat steps 2-5 for each alarm you wish to set. You can set a maximum of six alarms.

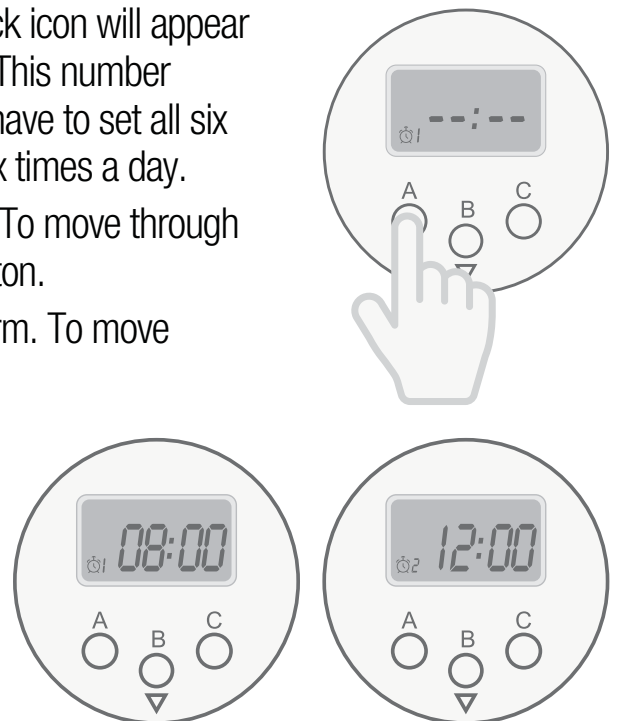

7. Once you have set anywhere from 1-6 alarms, depending on the medication schedule, press the **A** button until the numbers next to the clock go away and you see the main screen with the time. For example, if you only set one alarm, you will cycle through the clock next to 2, 3, 4, 5, 6, and then will return to the main menu.

Deleting an Alarm

1. Press **A** to enter the Alarm Menu.
2. Press **A** until you reach the alarm you want to delete.
3. Press **B** to cycle through the hours until you reach 11PM, and then press **B** again. You will see --:-- displayed on the screen.
4. Press **A** until you return to the main menu, and the alarm will be deleted.

Using your Automatic Pill Dispenser

1. Choose the Daily Dosage Ring that corresponds to your needs (please refer to “Understanding the Daily Dosage Rings” on page 6).
2. Situate the Daily Dosage Ring in the center of the internal pill container and place your medications in the container to correspond with when they are taken (1st, 2nd, 3rd, etc.) indicated by the numbers on the ring (1, 2, 3, etc.). Do not place any medication in the red sections. When you see the red approaching the dosage window, it is time to refill the container.
3. Install the batteries (please refer to “Installing the Batteries” on page 7).
4. Unlock the cover using the key (please refer to “Locking and Unlocking the Cover” on page 8) and place the internal pill container inside the main body.
5. Set the time (please refer to “Setting the Time” on page 8).
6. Adjust the alarm volume, alarm types, and choose 12- or 24-hour time (please refer to “Setting the Volume, Alarm Type, and 12-Hour/24-Hour Time” on page 8).
7. Set your medication times (please refer to “Setting Medication Times” on page 9).
8. Close the cover and lock it with the provided key (please refer to “Locking and Unlocking the Cover” on page 8).
9. At the designated medication times, the alert will sound. This will repeat every seven (7) seconds.

10. Use the magnifying viewer if needed to look into the container and see your pills and the corresponding number on the dosage ring to confirm that the internal pill container has rotated properly.
11. Slide open the window by pushing the latch to the left.
12. Fully invert the pill dispenser by turning it totally upside-down to receive the pills. Check to make sure all pills have come out of the compartment.
13. The alarm should stop. Close the dispensing window and replace the pill dispenser on a flat surface.

Care and Maintenance

- Wipe the exterior with a soft, damp cloth. Do not use harsh detergents.
- If needed, remove the internal compartment and gently rinse/wipe the individual pill compartments. Allow the compartment to dry fully before replacing it or refilling it.
- Do not immerse the outer pill dispenser in water or any other liquid.
- Make sure that the internal pill compartment is clean and dry before refilling it.

Specifications

- Power: 4x AA alkaline batteries (included)



NEED HELP?

If you experience any problems with your LiveFine[®] Automatic Pill Dispenser, please contact us at **supportlfc@camarketing.com or 888-390-7622** before returning your product to the place of purchase.

WE'RE HERE TO HELP!

LIVEFINE is a trademark of C&A IP Holdings, LLC in the US.

All other products, brand names, company names, and logos are trademarks of their respective owners, used merely to identify their respective products, and are not meant to connote any sponsorship, endorsement or approval.

Distributed by C&A Marketing, Inc., 114 Tived Lane East, Edison, NJ 08837. Made in China.

© 2019. C&A IP Holdings, LLC. All Rights Reserved.